

<b>Pictorial index</b>	Search by illustration	
<b>For safety and security</b>	Make sure to read through them (Main topics: Child seat, theft deterrent system)	1
<b>Vehicle status information and indicators</b>	Reading driving-related information (Main topics: Meters, multi-information display)	2
<b>Before driving</b>	Opening and closing the doors and windows, adjustment before driving (Main topics: Keys, doors, seats)	3
<b>Driving</b>	Operations and advice which are necessary for driving (Main topics: Starting engine, refueling)	4
<b>Interior features</b>	Usage of the interior features (Main topics: Air conditioner, storage features)	5
<b>Maintenance and care</b>	Caring for your vehicle and maintenance procedures (Main topics: Interior and exterior, light bulbs)	6
<b>When trouble arises</b>	What to do in case of malfunction and emergency (Main topics: Battery discharge, flat tire)	7
<b>Vehicle specifications</b>	Vehicle specifications, customizable features (Main topics: Fuel, oil, tire inflation pressure)	8
<b>For owners</b>	Reporting safety defects for U.S. owners, and seat belt, SRS airbag and headlight aim instructions for Canadian owners	9
<b>Index</b>	Search by symptom	
	Search alphabetically	

## 2 TABLE OF CONTENTS

For your information .....	5
Reading this manual.....	9
How to search.....	10
Pictorial index .....	11

### 1 For safety and security

<b>1-1. For safe use</b>	
Before driving.....	22
For safe driving .....	23
Seat belts .....	25
SRS airbags.....	32
Front passenger occupant classification system.....	41
Exhaust gas precautions.....	46
<b>1-2. Child safety</b>	
Riding with children.....	47
Child restraint systems.....	48
<b>1-3. Emergency assistance</b>	
Safety Connect .....	63
<b>1-4. Theft deterrent system</b>	
Engine immobilizer system ...	69
Alarm.....	71

### 2 Vehicle status information and indicators

<b>2-1. Instrument cluster</b>	
Warning lights and indicators .....	74
Gauges and meters .....	79
Multi-information display (4.2-inch display).....	82
Multi-information display (7-inch display).....	91
Head-up display .....	101
Fuel consumption information .....	106

### 3 Before driving

<b>3-1. Key information</b>	
Keys .....	112
<b>3-2. Opening, closing and locking the doors</b>	
Side doors.....	115
Back door.....	119
Smart key system .....	131
<b>3-3. Adjusting the seats</b>	
Front seats .....	138
Rear seats.....	139
Driving position memory ....	144
Head restraints.....	147
<b>3-4. Adjusting the steering wheel and mirrors</b>	
Steering wheel .....	150
Inside rear view mirror .....	151
Digital Rearview Mirror.....	152
Outside rear view mirrors...	162
<b>3-5. Opening, closing the windows and moon roof</b>	
Power windows .....	164
Moon roof.....	167
Panoramic moon roof.....	170

### 4 Driving

<b>4-1. Before driving</b>	
Driving the vehicle.....	177
Cargo and luggage .....	184
Vehicle load limits .....	187
Trailer towing.....	188
Dinghy towing .....	199
<b>4-2. Driving procedures</b>	
Engine (ignition) switch .....	200
Automatic transmission.....	204
Turn signal lever.....	208
Parking brake .....	209

Brake Hold ..... 212

**4-3. Operating the lights and wipers**

Headlight switch ..... 214

Automatic High Beam ..... 217

Fog light switch ..... 220

Windshield wipers and washer ..... 220

Rear windshield wiper and washer ..... 223

**4-4. Refueling**

Opening the fuel tank cap .. 225

**4-5. Using the driving support systems**

Toyota Safety Sense 2.0 .... 227

PCS (Pre-Collision System) ..... 233

LTA (Lane Tracing Assist)... 241

RSA (Road Sign Assist) .... 251

Dynamic radar cruise control with full-speed range..... 254

Stop & Start system ..... 264

BSM (Blind Spot Monitor)... 270

Intuitive parking assist..... 276

RCTA (Rear cross traffic alert) function ..... 284

PKSB (Parking Support Brake) ..... 289

Parking Support Brake function (static objects)..... 296

Parking Support Brake function (rear-crossing vehicles).... 302

Driving mode select switch ..... 306

Multi-terrain Select ..... 307

Snow mode switch ..... 310

Downhill assist control system ..... 311

Driving assist systems..... 313

**4-6. Driving tips**

Winter driving tips..... 319

Utility vehicle precautions... 322

**5 Interior features**

**5-1. Toyota multi-operation touch**

Toyota multi-operation touch ..... 326

**5-2. Using the air conditioning system and defogger**

Front manual air conditioning system ..... 328

Front automatic air conditioning system ..... 333

Rear manual air conditioning system ..... 346

Rear automatic air conditioning system ..... 348

Heated steering wheel/seat heaters/seat ventilators.... 352

**5-3. Using the interior lights**

Interior lights list ..... 355

**5-4. Using the storage features**

List of storage features ..... 358

Luggage compartment features ..... 363

**5-5. Using the other interior features**

Other interior features ..... 367

Garage door opener..... 379

**6 Maintenance and care**

**6-1. Maintenance and care**

Cleaning and protecting the vehicle exterior..... 388

Cleaning and protecting the vehicle interior..... 391

**6-2. Maintenance**

Maintenance requirements ..... 394

General maintenance..... 396

## 4 TABLE OF CONTENTS

Emission inspection and maintenance (I/M) programs.....	398
<b>6-3. Do-it-yourself maintenance</b>	
Do-it-yourself service precautions .....	400
Hood .....	402
Positioning a floor jack .....	403
Engine compartment.....	404
Tires .....	411
Tire inflation pressure.....	423
Wheels .....	425
Air conditioning filter.....	426
Electronic key battery.....	428
Checking and replacing fuses .....	429
Headlight aim .....	431
Light bulbs.....	432

## 7 When trouble arises

<b>7-1. Essential information</b>	
Emergency flashers .....	442
If your vehicle has to be stopped in an emergency .....	442
If the vehicle is trapped in rising water .....	443
<b>7-2. Steps to take in an emergency</b>	
If your vehicle needs to be towed .....	445
If you think something is wrong .....	448
Fuel pump shut off system .....	449
If a warning light turns on or a warning buzzer sounds ....	450
If a warning message is displayed .....	460
If you have a flat tire.....	464
If the engine will not start ...	478
If you lose your keys .....	479

If the fuel filler door cannot be opened .....	480
If the electronic key does not operate properly.....	481
If the vehicle battery is discharged .....	483
If your vehicle overheats ....	487
If the vehicle becomes stuck .....	489

## 8 Vehicle specifications

<b>8-1. Specifications</b>	
Maintenance data (fuel, oil level, etc.).....	492
Fuel information .....	503
Tire information .....	505
<b>8-2. Customization</b>	
Customizable features .....	515
<b>8-3. Initialization</b>	
Items to initialize .....	527

## 9 For owners

<b>9-1. For owners</b>	
Reporting safety defects for U.S. owners .....	530
Seat belt instructions for Canadian owners (in French) ...	530
SRS airbag instructions for Canadian owners (in French) .....	532
Headlight aim instructions for Canadian owners (in French) .....	539

## Index

What to do if... (Troubleshooting) .....	542
Alphabetical Index.....	545

## For your information

### Main Owner's Manual

Please note that this manual applies to explains all models and all equipment, including options. Therefore, you may find some explanations for equipment not installed on your vehicle.

All specifications provided in this manual are current at the time of printing. However, because of the Toyota policy of continual product improvement, we reserve the right to make changes at any time without notice.

Depending on specifications, the vehicle shown in the illustrations may differ from your vehicle in terms of color and equipment.

### Noise from under vehicle after turning off the engine

Approximately five hours after the engine is turned off, you may hear sound coming from under the vehicle for several minutes. This is the sound of a fuel evaporation leakage check and, it does not indicate a malfunction.

## Accessories, spare parts and modification of your Toyota

A wide variety of non-genuine spare parts and accessories for Toyota vehicles are currently available in the market. You should know that Toyota does not warrant these products and is not responsible for their performance, repair, or replacement, or for any damage they may cause to, or adverse effect they may have on, your Toyota vehicle.

This vehicle should not be modified with non-genuine Toyota products. Modification with non-genuine Toyota products could affect its performance, safety or durability, and may even violate governmental regulations. In addition, damage or performance problems resulting from the modification may not be covered under warranty.

### Installation of a mobile two-way radio system

The installation of a mobile two-way radio system in your vehicle could affect electronic systems such as:

- Multiport fuel injection system/sequential multiport fuel injection system
- Toyota Safety Sense 2.0

- Anti-lock brake system
- SRS airbag system
- Seat belt pretensioner system

Be sure to check with your Toyota dealer for precautionary measures or special instructions regarding installation of a mobile two-way radio system.

### Vehicle data recording

The vehicle is equipped with sophisticated computers that will record certain data, such as:

- Engine speed/Electric motor speed (traction motor speed)
- Accelerator status
- Brake status
- Vehicle speed
- Operation status of the driving assist systems
- Images from the cameras

Your vehicle is equipped with cameras. Contact your Toyota dealer for the location of recording cameras.

The recorded data varies according to the vehicle grade level and options with which it is equipped.

These computers do not record conversations or sounds, and only record images outside of the vehicle in certain situations.

- Data Transmission

Your vehicle may transmit the data recorded in these computers to Toyota without notification to you.

- Data usage

Toyota may use the data recorded in this computer to diagnose malfunctions, conduct research and development, and improve quality.

Toyota will not disclose the recorded data to a third party except:

- With the consent of the vehicle owner or with the consent of the lessee if the vehicle is leased
- In response to an official request by the police, a court of law or a government agency
- For use by Toyota in a lawsuit
- For research purposes where the data is not tied to a specific vehicle or vehicle owner
- Recorded image information can be erased by your Toyota dealer.

The image recording function can be disabled. However, if the function is disabled, data from when the system operates will not be available.

- To learn more about the vehicle data collected, used and shared by Toyota, please visit [www.toyota.com/privacyvts/](http://www.toyota.com/privacyvts/).

### Usage of data collected through Safety Connect (U.S. mainland only)

If your Toyota has Safety Connect and if you have subscribed to those services, please refer to the Safety Connect Telematics Subscription Service Agreement for information on data collected

and its usage.

To learn more about the vehicle data collected, used and shared by Toyota, please visit [www.toyota.com/privacyvts/](http://www.toyota.com/privacyvts/).

### Event data recorder

This vehicle is equipped with an event data recorder (EDR). The main purpose of an EDR is to record, in certain crash or near crash-like situations, such as an air bag deployment or hitting a road obstacle, data that will assist in understanding how a vehicle's systems performed. The EDR is designed to record data related to vehicle dynamics and safety systems for a short period of time, typically 30 seconds or less.

The EDR in this vehicle is designed to record such data as:

- How various systems in your vehicle were operating;
- Whether or not the driver and passenger safety belts were buckled/fastened;
- How far (if at all) the driver was depressing the accelerator and/or brake pedal; and,
- How fast the vehicle was traveling.

These data can help provide a better understanding of the circumstances in which crashes and injuries occur.

NOTE: EDR data are recorded by your vehicle only if a non-trivial crash situation occurs; no data are recorded by the EDR under normal driving conditions and no personal data (e.g., name, gender, age, and crash location) are recorded. However, other parties, such as law enforcement, could combine the EDR data with the type of personally identifying data routinely acquired during a crash investigation.

To read data recorded by an EDR, special equipment is required, and access to the vehicle or the EDR is needed. In addition to the vehicle manufacturer, other parties, such as law enforcement, that have the special equipment, can read the information if they have access to the vehicle or the EDR.

#### ● Disclosure of the EDR data

Toyota will not disclose the data recorded in an EDR to a third party except when:

- An agreement from the vehicle's owner (or the lessee for a leased vehicle) is obtained
- In response to an official request by the police, a court of law or a government agency
- For use by Toyota in a lawsuit

However, if necessary, Toyota may:

- Use the data for research on vehicle safety performance
- Disclose the data to a third party

for research purposes without disclosing information about the specific vehicle or vehicle owner

### Scrapping of your Toyota

The SRS airbag and seat belt pretensioner devices in your Toyota contain explosive chemicals. If the vehicle is scrapped with the airbags and seat belt pretensioners left as they are, this may cause an accident such as fire. Be sure to have the systems of the SRS airbag and seat belt pretensioner removed and disposed of by a qualified service shop or by your Toyota dealer before you scrap your vehicle.

### Perchlorate Material

Special handling may apply, See [www.dtsc.ca.gov/hazardouswaste/perchlorate](http://www.dtsc.ca.gov/hazardouswaste/perchlorate).

Your vehicle has components that may contain perchlorate. These components may include airbag, seat belt pretensioners, and wireless remote control batteries.

### WARNING

#### ■ General precautions while driving

**Driving under the influence:** Never drive your vehicle when under the influence of alcohol or drugs that have impaired your ability to operate your vehicle. Alcohol and certain drugs delay reaction time, impair judgment and reduce coordination, which could lead to an accident that could result in death or serious injury.

**Defensive driving:** Always drive defensively. Anticipate mistakes that other drivers or pedestrians might make and be ready to avoid accidents.

**Driver distraction:** Always give your full attention to driving. Anything that distracts the driver, such as adjusting controls, talking on a cellular phone or reading can result in a collision with resulting death or serious injury to you, your occupants or others.

#### ■ General precaution regarding children's safety

Never leave children unattended in the vehicle, and never allow children to have or use the key.



Children may be able to start the vehicle or shift the vehicle into neutral. There is also a danger that children may injure themselves by playing with the windows, the moon roof or panoramic moon roof, or other features of the vehicle. In addition, heat build-up or extremely cold temperatures inside the vehicle can be fatal to children.





**Reading this manual**



**Explains symbols used in this manual.**

**Symbols in this manual**

Symbols	Meanings
	<b>WARNING:</b> Explains something that, if not obeyed, could cause death or serious injury to people.
	<b>NOTICE:</b> Explains something that, if not obeyed, could cause damage to or a malfunction in the vehicle or its equipment.
1 2 3...	Indicates operating or working procedures. Follow the steps in numerical order.

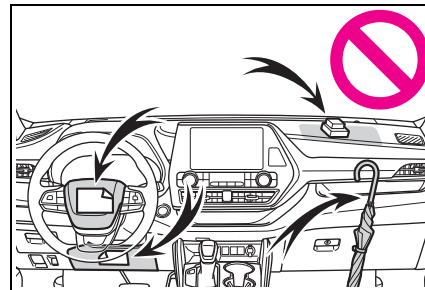
Symbols	Meanings
	Indicates the action (pushing, turning, etc.) used to operate switches and other devices.
	Indicates the outcome of an operation (e.g. a lid opens).



Symbols	Meanings
	Indicates the component or position being explained.
	Means <b>Do not</b> , <b>Do not do this</b> , or <b>Do not let this happen</b> .

**Symbols in illustrations**

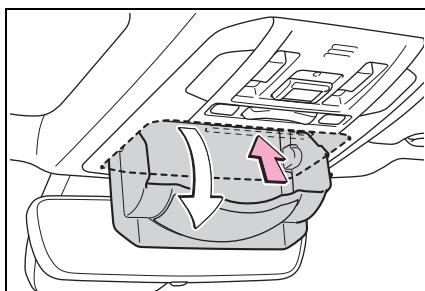

**How to search****■ Searching by name**

- Alphabetical index: →P.545

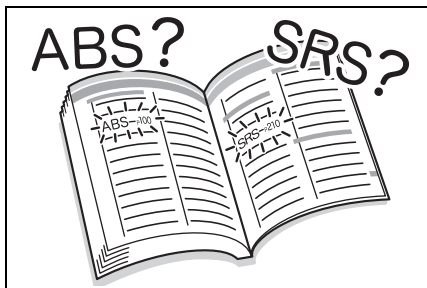
**■ Searching by installation position**

- Pictorial index: →P.11

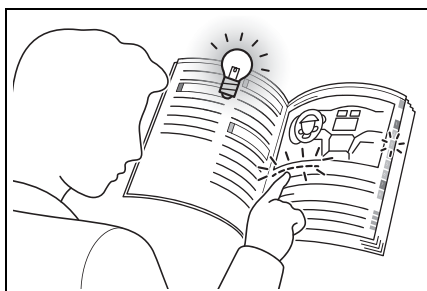
**■ Searching by symptom or sound**

- What to do if... (Troubleshooting): →P.542

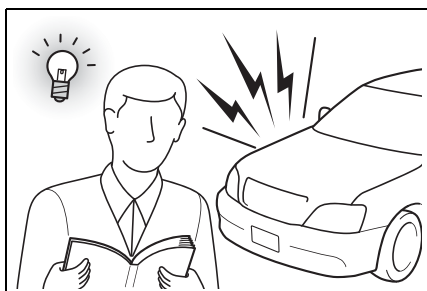
**■ Searching by title**

- Table of contents: →P.2

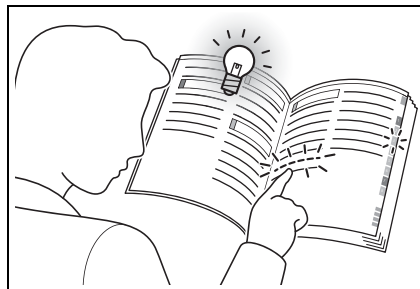

## Pictorial index

### ■ Exterior

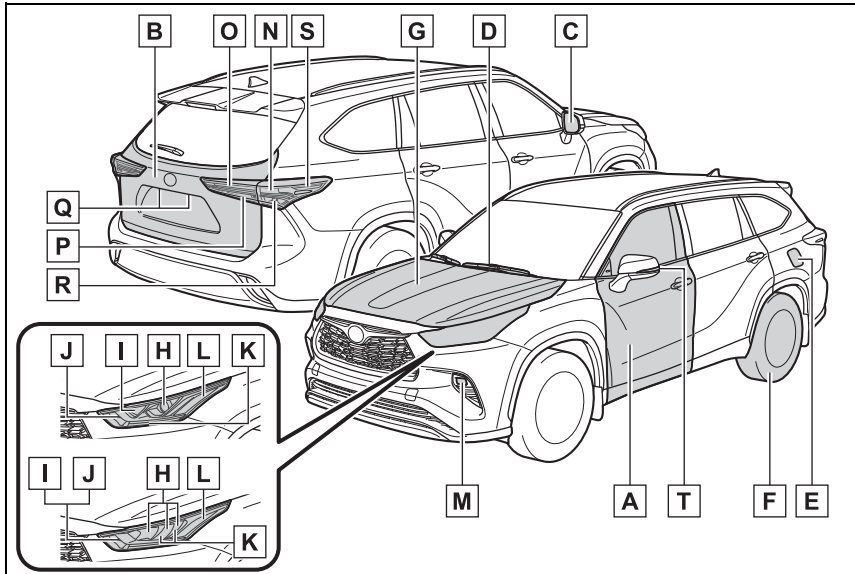

The shape of the lights may differ depending on the grade, etc.

- A Side doors ..... P.115**
  - Locking/unlocking ..... P.115
  - Opening/closing the side windows ..... P.164
  - Locking/unlocking by using the mechanical key ..... P.481
  - Warning lights/warning messages ..... P.450, 460
- B Back door ..... P.119**
  - Opening from inside the cabin \* ..... P.122
  - Opening from outside ..... P.123
  - Warning lights/warning messages ..... P.450, 460
- C Outside rear view mirrors ..... P.162**
  - Adjusting the mirror angle ..... P.162
  - Folding the mirrors ..... P.163
  - Driving position memory \* ..... P.144
  - Defogging the mirrors ..... P.329, 335
- D Windshield wipers ..... P.220**

## 12 Pictorial index

	Precautions for winter season.....	P.319
	To prevent freezing (windshield wiper de-icer).....	P.330, 335
	Precautions for car wash * .....	P.389
<b>E</b>	<b>Fuel filler door .....</b>	<b>P.225</b>
	Refueling method .....	P.225
	Fuel type/fuel tank capacity .....	P.495
<b>F</b>	<b>Tires.....</b>	<b>P.411</b>
	Tire size/inflation pressure .....	P.411, 499
	Winter tires/tire chains .....	P.319
	Checking/rotation/tire pressure warning system .....	P.411
	Coping with flat tires.....	P.464
<b>G</b>	<b>Hood.....</b>	<b>P.402</b>
	Opening .....	P.402
	Engine oil .....	P.495
	Coping with overheating .....	P.487
	Warning messages .....	P.460

### Light bulbs of the exterior lights for driving

(Replacing method: P.432, Watts: P.501)

<b>H</b>	<b>Headlights.....</b>	<b>P.214</b>
<b>I</b>	<b>Parking lights .....</b>	<b>P.214</b>
<b>J</b>	<b>Front turn signal lights .....</b>	<b>P.208</b>
<b>K</b>	<b>Parking lights*/daytime running lights.....</b>	<b>P.214</b>
<b>L</b>	<b>Front side marker lights .....</b>	<b>P.214</b>
<b>M</b>	<b>Front fog lights* .....</b>	<b>P.220</b>
<b>N</b>	<b>Stop/tail lights .....</b>	<b>P.214</b>
<b>O</b>	<b>Tail lights.....</b>	<b>P.214</b>
<b>P</b>	<b>Back-up lights</b>	
	Shifting the shift lever to R .....	P.204
<b>Q</b>	<b>License plate lights.....</b>	<b>P.214</b>
<b>R</b>	<b>Rear turn signal lights .....</b>	<b>P.208</b>

**S** Rear side marker lights ..... P.214

**T** Side turn signal lights ..... P.208

\* : If equipped

■ Instrument panel

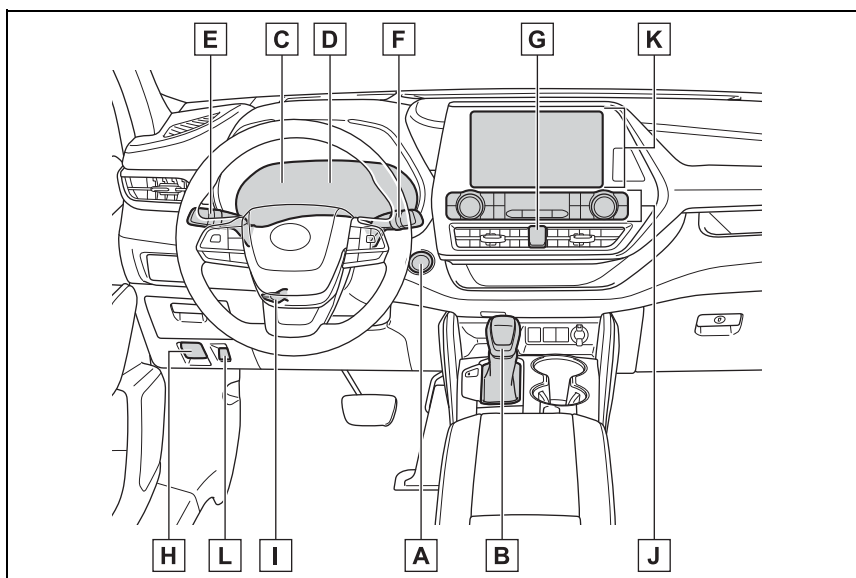

<b>A</b>	<b>Engine switch</b> .....	<b>P.200</b>
	Starting the engine/changing the modes .....	P.200
	Emergency stop of the engine .....	P.442
	When the engine will not start .....	P.478
	Warning messages .....	P.460
<b>B</b>	<b>Shift lever</b> .....	<b>P.204</b>
	Changing the shift position .....	P.205
	Precautions for towing .....	P.445
	When the shift lever does not move .....	P.206
<b>C</b>	<b>Meters</b> .....	<b>P.79</b>
	Reading the meters/adjusting the instrument panel light .	P.79, 81
	Warning lights/indicator lights .....	P.74
	When a warning light turns on .....	P.450
<b>D</b>	<b>Multi-information display</b> .....	<b>P.82, 91</b>
	Display .....	P.82, 91
	When the warning messages are displayed .....	P.460

<b>E</b>	<b>Turn signal lever</b> .....	<b>P.208</b>
	<b>Headlight switch</b> .....	<b>P.214</b>
	Headlights/side marker lights/parking lights/tail lights/license plate lights/daytime running lights.....	P.214
	Front fog lights <sup>*1</sup> .....	P.220
<b>F</b>	<b>Windshield wiper and washer switch</b> .....	<b>P.220, 223</b>
	Usage.....	P.220, 223
	Adding washer fluid.....	P.410
	Warning messages .....	P.460
<b>G</b>	<b>Emergency flasher switch</b> .....	<b>P.442</b>
<b>H</b>	<b>Hood lock release lever</b> .....	<b>P.402</b>
<b>I</b>	<b>Tilt and telescopic steering lock release lever</b> .....	<b>P.150</b>
	Adjustment .....	P.150
<b>J</b>	<b>Air conditioning system</b> .....	<b>P.328, 333</b>
	Usage.....	P.328, 333
	Rear window defogger .....	P.329, 335
	Windshield wiper de-icer <sup>*1</sup> .....	P.330, 335
<b>K</b>	<b>Audio system</b> <sup>*2</sup>	
<b>L</b>	<b>Fuel filler door opener switch</b> .....	<b>P.225</b>

<sup>\*1</sup>: If equipped

<sup>\*2</sup>: Refer to "NAVIGATION AND MULTIMEDIA SYSTEM OWNER'S MANUAL".

■ Switches

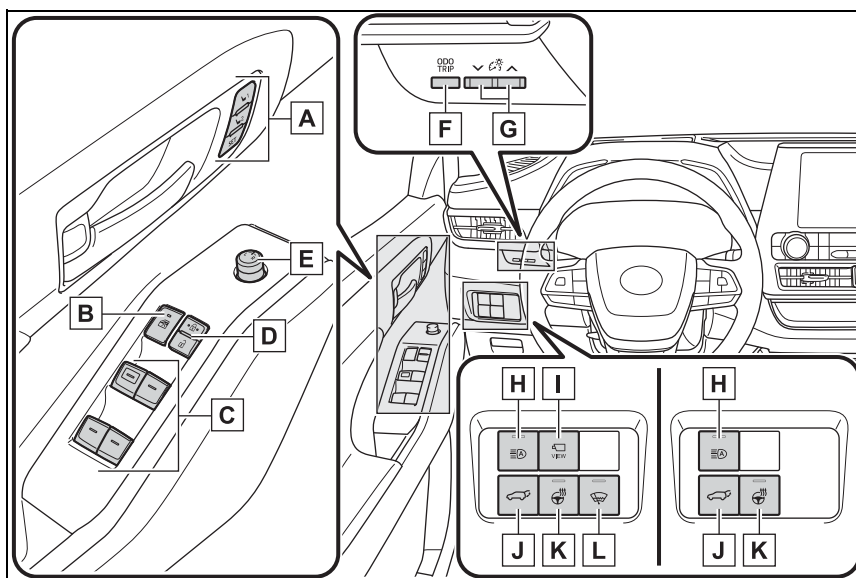

<b>A</b>	<b>Driving position memory switches <sup>*1</sup></b> .....	<b>P.144</b>
<b>B</b>	<b>Window lock switch</b> .....	<b>P.166</b>
<b>C</b>	<b>Power window switches</b> .....	<b>P.164</b>
<b>D</b>	<b>Door lock switches</b> .....	<b>P.118</b>
<b>E</b>	<b>Outside rear view mirror switches</b> .....	<b>P.162</b>
<b>F</b>	<b>“ODO TRIP” switch</b> .....	<b>P.81</b>
<b>G</b>	<b>Instrument panel light control switches</b> .....	<b>P.81</b>
<b>H</b>	<b>Automatic High Beam switch</b> .....	<b>P.217</b>
<b>I</b>	<b>Camera switch <sup>*2</sup></b>	
<b>J</b>	<b>Power back door switch <sup>*1</sup></b> .....	<b>P.122</b>
<b>K</b>	<b>Heated steering wheel switch <sup>*1</sup></b> .....	<b>P.352</b>
<b>L</b>	<b>Windshield wiper de-icer <sup>*1</sup></b> .....	<b>P.343</b>

<sup>\*1</sup>: If equipped

<sup>\*2</sup>: Refer to “NAVIGATION AND MULTIMEDIA SYSTEM OWNER’S MANUAL”.



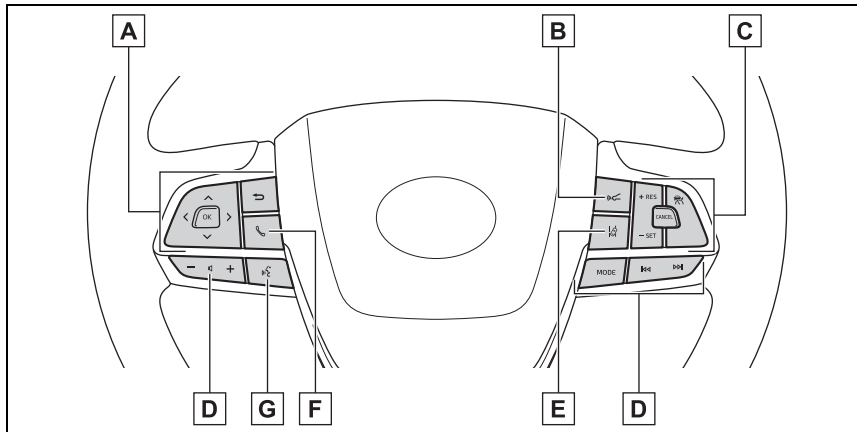

- A** Meter control switches ..... P.83, 92
- B** Vehicle-to-vehicle distance switch ..... P.258
- C** Cruise control switch  
Dynamic radar cruise control with full-speed range ..... P.254
- D** Audio remote control switches \*
- E** LTA (Lane Tracing Assist) switch ..... P.241
- F** Phone switch \*
- G** Talk switch \*

\*: Refer to "NAVIGATION AND MULTIMEDIA SYSTEM OWNER'S MANUAL".

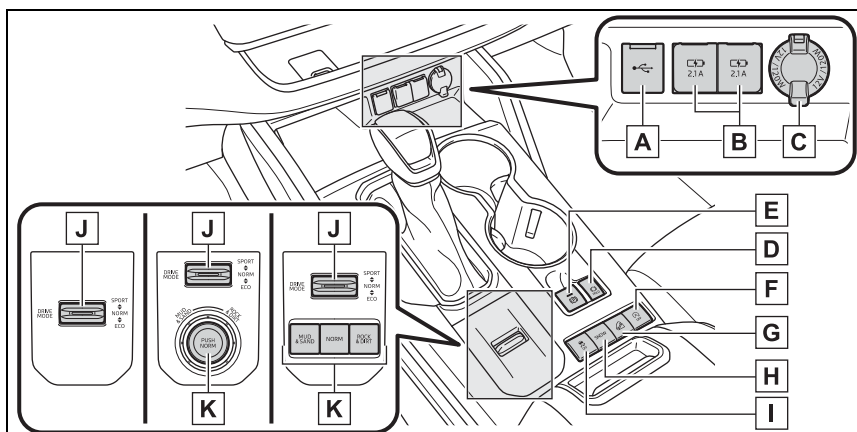

<b>A</b>	<b>USB port</b> <sup>*1</sup>	
<b>B</b>	<b>USB charging ports</b> .....	<b>P.367</b>
<b>C</b>	<b>Power outlet</b> .....	<b>P.376</b>
<b>D</b>	<b>Brake hold switch</b> .....	<b>P.212</b>
<b>E</b>	<b>Parking brake switch</b> .....	<b>P.209</b>
	Applying/releasing .....	P.209
	Precautions against winter season .....	P.319
	Warning buzzer/light/message .....	P.460
<b>F</b>	<b>Stop &amp; Start cancel switch</b> <sup>*2</sup> .....	<b>P.265</b>
<b>G</b>	<b>“DAC” switch</b> <sup>*2</sup> .....	<b>P.311</b>
<b>H</b>	<b>Snow mode switch</b> .....	<b>P.310</b>
<b>I</b>	<b>VSC OFF switch</b> .....	<b>P.314</b>
<b>J</b>	<b>Driving mode select switch</b> .....	<b>P.306</b>
<b>K</b>	<b>Multi-terrain Select switch</b> <sup>*2</sup> .....	<b>P.307</b>

<sup>\*1</sup>: Refer to “NAVIGATION AND MULTIMEDIA SYSTEM OWNER’S MANUAL”.

<sup>\*2</sup>: If equipped

■ Interior

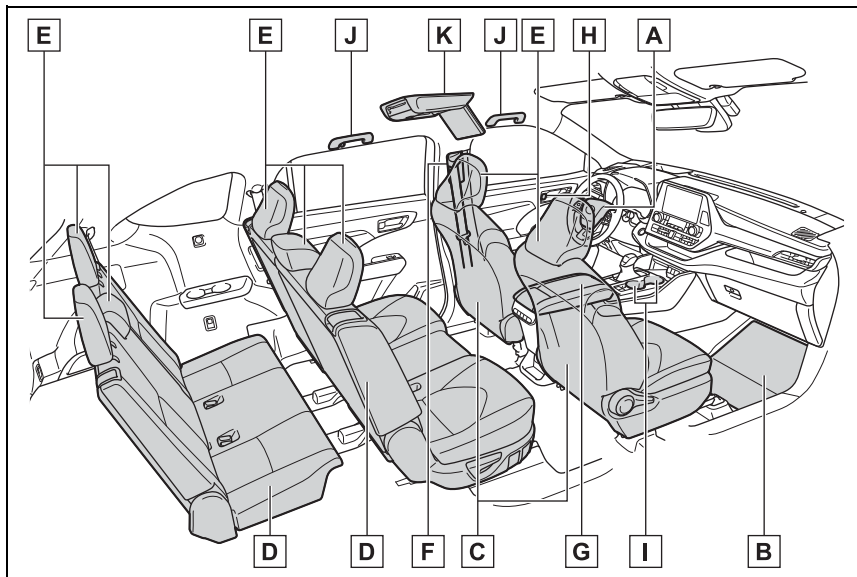

<b>A</b> SRS airbags .....	<b>P.32</b>
<b>B</b> Floor mats .....	<b>P.22</b>
<b>C</b> Front seats .....	<b>P.138</b>
<b>D</b> Rear seats .....	<b>P.139</b>
<b>E</b> Head restraints .....	<b>P.147</b>
<b>F</b> Seat belts .....	<b>P.25</b>
<b>G</b> Console box .....	<b>P.359</b>
<b>H</b> Inside lock buttons .....	<b>P.118</b>
<b>I</b> Cup holders .....	<b>P.360</b>
<b>J</b> Assist grips .....	<b>P.375</b>
<b>K</b> Rear seat entertainment system *1, 2	

\*1: If equipped

\*2: Refer to "NAVIGATION AND MULTIMEDIA SYSTEM OWNER'S MANUAL".

■ Ceiling

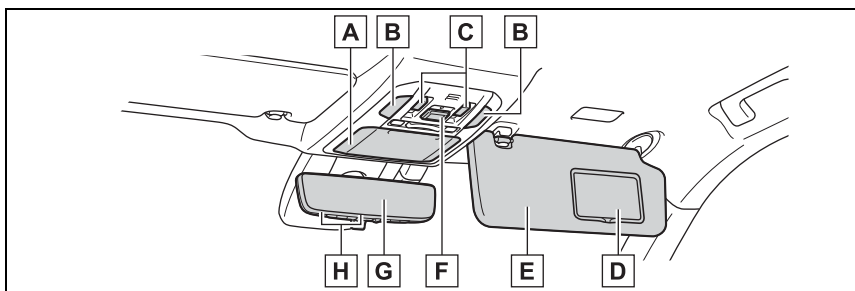

<b>A</b>	<b>Auxiliary box</b> .....	<b>P.361</b>
	<b>Conversation mirror</b> .....	<b>P.378</b>
<b>B</b>	<b>Interior light</b> <sup>*1</sup> .....	<b>P.356</b>
	<b>Personal lights</b> <sup>*1</sup> .....	<b>P.356</b>
<b>C</b>	<b>Moon roof switches</b> <sup>*2</sup> .....	<b>P.167</b>
	<b>Panoramic moon roof switches</b> <sup>*2</sup> .....	<b>P.170</b>
<b>D</b>	<b>Vanity mirrors</b> .....	<b>P.377</b>
<b>E</b>	<b>Sun visors</b> .....	<b>P.377</b>
<b>F</b>	<b>“SOS” button</b> <sup>*2</sup> .....	<b>P.63</b>
<b>G</b>	<b>Inside rear view mirror</b> <sup>*2</sup> .....	<b>P.151</b>
	<b>Digital Rearview Mirror</b> <sup>*2</sup> .....	<b>P.152</b>
<b>H</b>	<b>Garage door opener switches</b> <sup>*2</sup> .....	<b>P.379</b>

<sup>\*1</sup>: The illustration shows the front, but they are also equipped in the rear.

<sup>\*2</sup>: If equipped

**For safety and security**

1

21

**1-1. For safe use**

- Before driving ..... **22**
- For safe driving ..... **23**
- Seat belts ..... **25**
- SRS airbags ..... **32**
- Front passenger occupant classification system .... **41**
- Exhaust gas precautions ..... **46**

**1-2. Child safety**

- Riding with children ..... **47**
- Child restraint systems... **48**

**1-3. Emergency assistance**

- Safety Connect ..... **63**

**1-4. Theft deterrent system**

- Engine immobilizer system ..... **69**
- Alarm ..... **71**

1

For safety and security

### Before driving

Observe the following before starting off in the vehicle to ensure safety of driving.

### Installing floor mats

Use only floor mats designed specifically for vehicles of the same model and model year as your vehicle. Fix them securely in place onto the carpet.

- 1 Insert the retaining hooks (clips) into the floor mat eyelets.

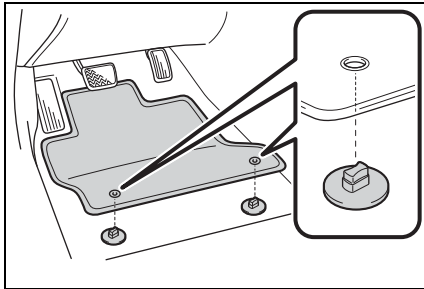

- 2 Turn the upper knob of each retaining hook (clip) to secure the floor mats in place.

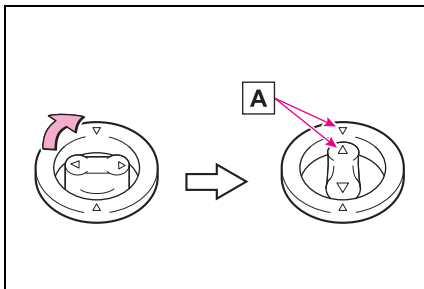

Always align the  $\triangle$  marks **A**.

The shape of the retaining hooks (clips) may differ from that shown in the illustration.

### WARNING

Observe the following precautions.

Failure to do so may cause the driver's floor mat to slip, possibly interfering with the pedals while driving. An unexpectedly high speed may result or it may become difficult to stop the vehicle. This could lead to an accident, resulting in death or serious injury.

#### When installing the driver's floor mat

- Do not use floor mats designed for other models or different model year vehicles, even if they are Toyota Genuine floor mats.
- Only use floor mats designed for the driver's seat.
- Always install the floor mat securely using the retaining hooks (clips) provided.
- Do not use two or more floor mats on top of each other.
- Do not place the floor mat bottom-side up or upside-down.

**⚠ WARNING****■ Before driving**

- Check that the floor mat is securely fixed in the correct place with all the provided retaining hooks (clips). Be especially careful to perform this check after cleaning the floor.

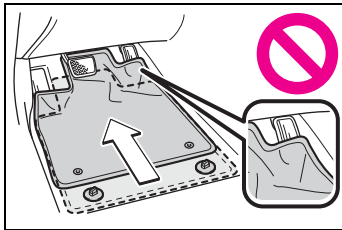

- With the engine stopped and the shift lever in P, fully depress each pedal to the floor to make sure it does not interfere with the floor mat.

**For safe driving**

**For safe driving, adjust the seat and mirror to an appropriate position before driving.**

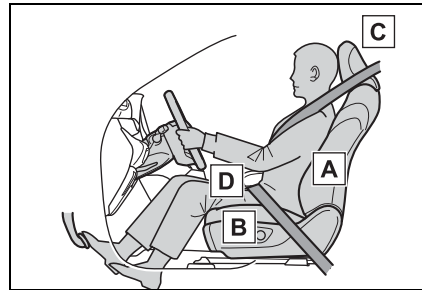
**Correct driving posture**

- A** Adjust the angle of the seat-back so that you are sitting straight up and so that you do not have to lean forward to steer. (→P.138)
- B** Adjust the seat so that you can depress the pedals fully and so that your arms bend slightly at the elbow when gripping the steering wheel. (→P.138)
- C** Lock the head restraint in place with the center of the head restraint closest to the top of your ears. (→P.147)
- D** Wear the seat belt correctly. (→P.25)

1

For safety and security

**WARNING****■ For safe driving**

Observe the following precautions. Failure to do so may result in death or serious injury.

- Do not adjust the position of the driver's seat while driving. Doing so could cause the driver to lose control of the vehicle.
- Do not place a cushion between the driver or passenger and the seatback. A cushion may prevent correct posture from being achieved, and reduce the effectiveness of the seat belt and head restraint.
- Do not place anything under the front seats. Objects placed under the front seats may become jammed in the seat tracks and stop the seat from locking in place. This may lead to an accident and the adjustment mechanism may also be damaged.
- Always observe the legal speed limit when driving on public roads.
- When driving over long distances, take regular breaks before you start to feel tired. Also, if you feel tired or sleepy while driving, do not force yourself to continue driving and take a break immediately.

**Correct use of the seat belts**

Make sure that all occupants are wearing their seat belts before driving the vehicle. (→P.25)

Use a child restraint system appropriate for the child until the child becomes large enough to

properly wear the vehicle's seat belt. (→P.48)

**Adjusting the mirrors**

Make sure that you can see backward clearly by adjusting the inside and outside rear view mirrors properly. (→P.151, 152, 162)



## Seat belts

**Make sure that all occupants are wearing their seat belts before driving the vehicle.**

### WARNING

Observe the following precautions to reduce the risk of injury in the event of sudden braking, sudden swerving or an accident. Failure to do so may cause death or serious injury.

#### ■ Wearing a seat belt

- Ensure that all passengers wear a seat belt.
- Always wear a seat belt properly.
- Each seat belt should be used by one person only. Do not use a seat belt for more than one person at once, including children.
- Toyota recommends that children be seated in the rear seat and always use a seat belt and/or an appropriate child restraint system.
- To achieve a proper seating position, do not recline the seat more than necessary. The seat belt is most effective when the occupants are sitting up straight and well back in the seats.
- Do not wear the shoulder belt under your arm.
- Always wear your seat belt low and snug across your hips.

#### ■ Pregnant women

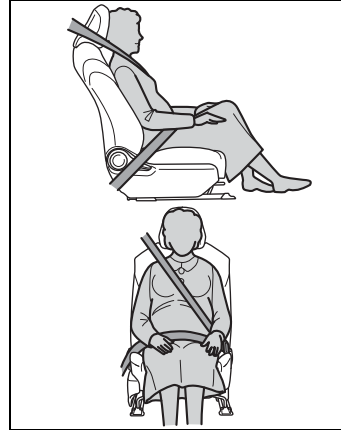

Obtain medical advice and wear the seat belt in the proper way. (→P.26)

Women who are pregnant should position the lap belt as low as possible over the hips in the same manner as other occupants, extending the shoulder belt completely over the shoulder and avoiding belt contact with the rounding of the abdominal area.

If the seat belt is not worn properly, not only the pregnant woman, but also the fetus could suffer death or serious injury as a result of sudden braking or a collision.

#### ■ People suffering illness

Obtain medical advice and wear the seat belt in the proper way. (→P.26)

#### ■ When children are in the vehicle

→P.57

#### ■ Seat belt damage and wear

- Do not damage the seat belts by allowing the belt, plate, or buckle to be jammed in the door.

**⚠ WARNING**

- Inspect the seat belt system periodically. Check for cuts, fraying, and loose parts. Do not use a damaged seat belt until it is replaced. Damaged seat belts cannot protect an occupant from death or serious injury.
- Ensure that the belt and plate are locked and the belt is not twisted. If the seat belt does not function correctly, immediately contact your Toyota dealer.
- Replace the seat assembly, including the belts, if your vehicle has been involved in a serious accident, even if there is no obvious damage.
- Do not attempt to install, remove, modify, disassemble or dispose of the seat belts. Have any necessary repairs carried out by your Toyota dealer. Inappropriate handling may lead to incorrect operation.

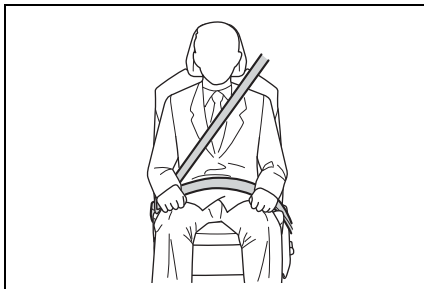
**Correct use of the seat belts**

- Extend the shoulder belt so that it comes fully over the shoulder, but does not come into contact with the neck or slide off the shoulder.
- Position the lap belt as low as

possible over the hips.

- Adjust the position of the seatback. Sit up straight and well back in the seat.
- Do not twist the seat belt.

**■ Emergency locking retractor (ELR)**

The retractor will lock the belt during a sudden stop or on impact. It may also lock if you lean forward too quickly. A slow, easy motion will allow the belt to extend so that you can move around fully.

**■ Automatic locking retractor (ALR)**

When a passenger's shoulder belt is completely extended and then retracted even slightly, the belt is locked in that position and cannot be extended. This feature is used to hold the child restraint system (CRS) firmly. To free the belt again, fully retract the belt and then pull the belt out once more. (→P.48)

**■ Child seat belt usage**

The seat belts of your vehicle were principally designed for persons of adult size.

- Use a child restraint system appropriate for the child, until the child becomes large enough to properly wear the vehicle's seat belt. (→P.48)
- When the child becomes large enough to properly wear the vehicle's seat belt, follow the instructions regarding seat belt usage. (→P.25)

**■ Seat belt extender**

If your seat belts cannot be fastened securely because they are not long enough, a personalized seat belt extender is available from your Toyota dealer free of charge.

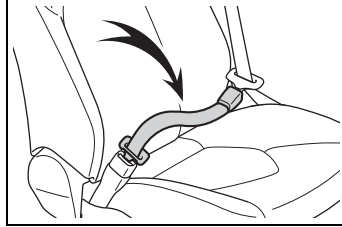

**⚠ WARNING**

■ **Using a seat belt extender**

Observe the following precautions to reduce the risk of injury in the event of sudden braking, sudden swerving or an accident. Failure to do so may cause death or serious injury.

- Do not wear the seat belt extender if you can fasten the seat belt without the extender.
- Do not use the seat belt extender when installing a child restraint system because the belt will not securely hold the child restraint system, increasing the risk of death or serious injury in the event of an accident.
- The personalized extender may not be safe on another vehicle, when used by another person, or at a different seating position other than the one originally intended.

**⚠ NOTICE**

■ **When using a seat belt extender**

When releasing the seat belt, press on the buckle release button on the extender, not on the seat belt. This helps prevent damage to the vehicle interior and the extender itself.

**Fastening and releasing the seat belt (except for the third center seat)**

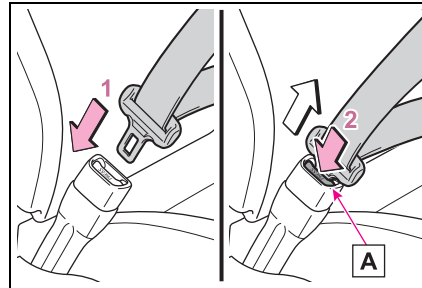

- 1 To fasten the seat belt, push the plate into the buckle until a click sound is heard.
- 2 To release the seat belt, press the release button **A**.

■ **When not using the rear seat belts**

Pass the outer seat belts through the seat belt hangers and secure the seat belt plates to prevent the shoulder belts from being damaged.

▶ **Second seat belts**

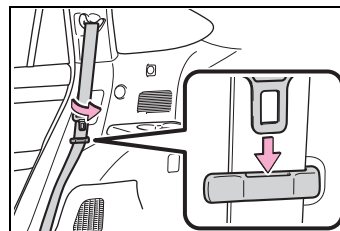

▶ **Third seat belts**

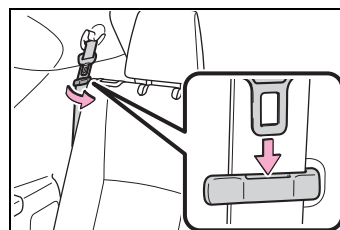

### Fastening the seat belt (for the third center seat)

- 1 Take the plate out of the holder, and then pull down the seat belt.

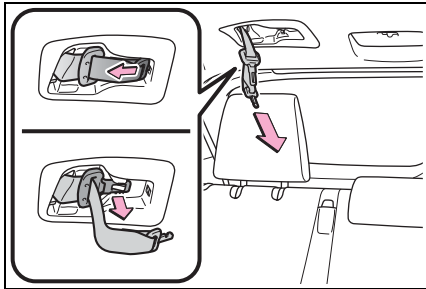

- 2 Push plate **A** into buckle **B** until a click sound is heard.

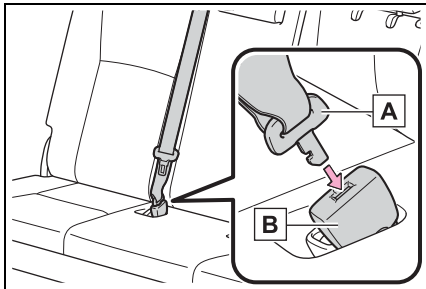

- 3 Push plate **C** into buckle **D** until a click sound is heard.

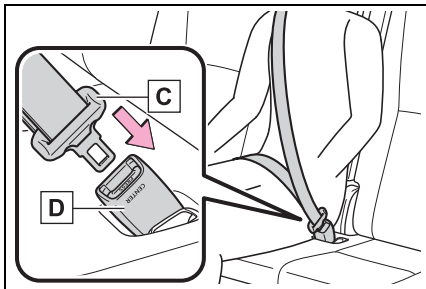

### ⚠ WARNING

- When using the third center seat belt

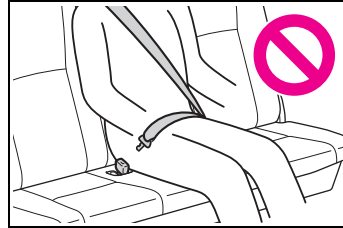

Do not use the third center seat belt with either buckle released. Fastening only one of the buckles may result in death or serious injury in case of sudden braking, sudden swerving or a collision.

### Fastening the seat belt (for the third center seat)

- 1 To release plate **C**, press the release button **E** on buckle **D**.

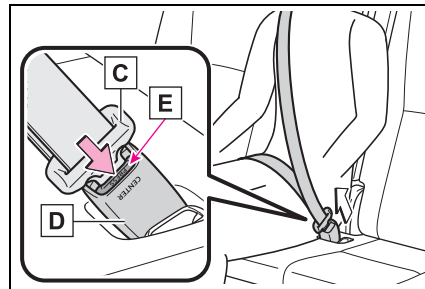

- 2 To release plate **A**, insert the mechanical key (→P.112) or plate **C** into the hole on buckle **B**.

Retract the belt slowly when releas-

ing and stowing the seat belt.

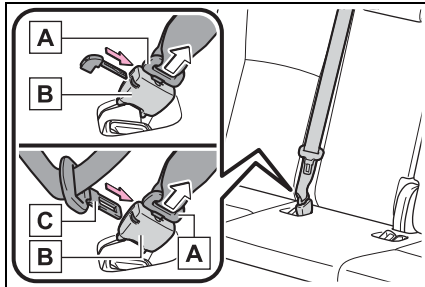

**3** Stow the plate **C** and **A** in the holder on the roof.

In order to securely stow them, firmly insert them as far as possible.

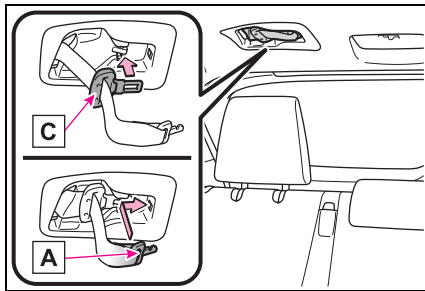

**Adjusting the seat belt shoulder anchor height (front seats)**

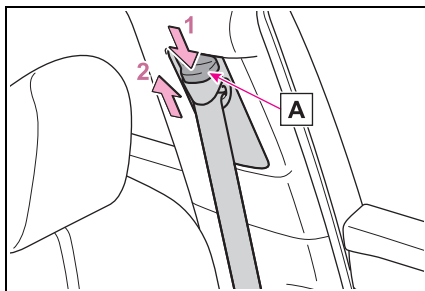

- 1** Push the seat belt shoulder anchor down while pressing the release button **A**.
- 2** Push the seat belt shoulder

anchor up.

Move the height adjuster up and down as needed until you hear a click.

**! WARNING**

**Adjustable shoulder anchor**

Always make sure the shoulder belt is positioned across the center of your shoulder. The belt should be kept away from your neck, but not falling off your shoulder. Failure to do so could reduce the amount of protection in an accident and cause death or serious injuries in the event of a sudden stop, sudden swerve or accident.

**Seat belt comfort guide (for the third center seat)**

If the shoulder belt sits close to a person's neck, use the seat belt comfort guide.

- 1** Pull the comfort guide from the pocket.

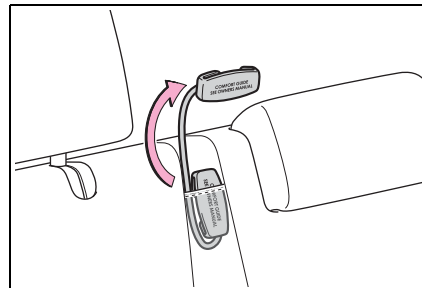

- 2** Slide the belt past the slot of the guide.

The elastic cord must be behind the

seat belt.

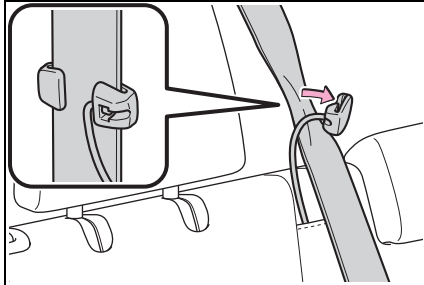

3 Buckle the seat belt and position it comfortably.

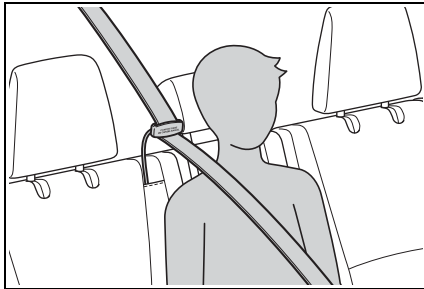

**⚠ WARNING**

■ **Using a seat belt comfort guide**

Failure to observe the following precautions could reduce the effectiveness of the seat belt in an accident, causing death or serious injury.

- Make sure the belt is not twisted and that it lies flat. The elastic cord must be behind the belt and the guide must be on the front.
- To reduce the chance of injury in case of a sudden stop, sudden swerve or accident while driving, remove and store the comfort guide in its pocket when it is not in use.

- Always make sure the shoulder belt is positioned across the center of the shoulder. The belt should be kept away from the neck, and should not fall off the shoulder.

**Seat belt pretensioners (front seats)**

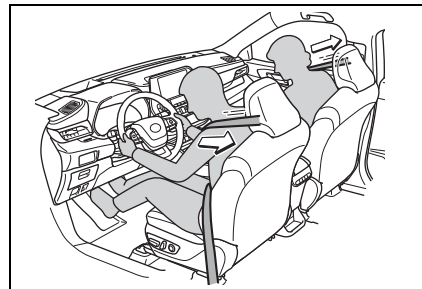

The pretensioners help the seat belts to quickly restrain the occupants by retracting the seat belts when the vehicle is subjected to certain types of severe frontal or side collision or a vehicle rollover.

The pretensioners do not activate in the event of a minor frontal impact, a minor side impact or a rear impact.

■ **Replacing the belt after the pretensioner has been activated**

If the vehicle is involved in multiple collisions, the pretensioner will activate for the first collision, but will not activate for the second or subsequent collisions.

**WARNING****■ Seat belt pretensioners**

Observe the following precautions to reduce the risk of injury in the event of sudden braking, sudden swerving or an accident. Failure to do so may cause death or serious injury.

- Do not place anything, such as a cushion, on the front passenger's seat. Doing so will disperse the passenger's weight, which prevents the sensor from detecting the passenger's weight properly. As a result, the seat belt pretensioner for the front passenger's seat may not activate in the event of a collision.
- If the pretensioner has activated, the SRS warning light will come on. In that case, the seat belt cannot be used again and must be replaced at your Toyota dealer.

## SRS airbags

The SRS airbags inflate when the vehicle is subjected to certain types of severe impacts that may cause significant injury to the occupants. They work together with the seat belts to help reduce the risk of death or serious injury.

### SRS airbag system

#### ■ Location of the SRS airbags

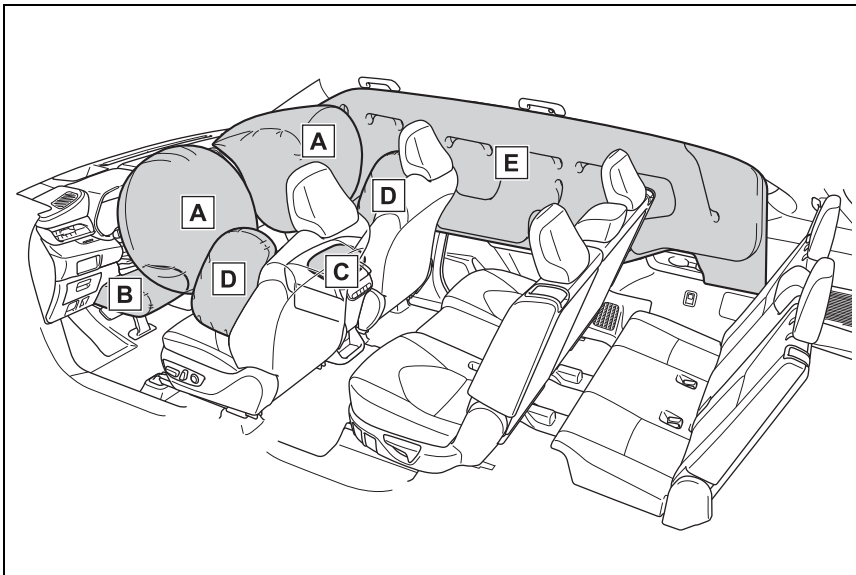

#### ► SRS front airbags

##### **A** SRS driver airbag/front passenger airbag

Can help protect the head and chest of the driver and front passenger from impact with interior components

##### **B** SRS knee airbag

Can help provide driver protection

##### **C** SRS seat cushion airbag

Can help restrain the front passenger

#### ► SRS side and curtain shield airbags

##### **D** SRS front side airbags

Can help protect the torso of the front seat occupants



### E SRS curtain shield airbags

- Can help protect primarily the head of occupants in the outer seats
- Can help prevent the occupants from being thrown from the vehicle in the event of vehicle rollover

### ■ SRS airbag system components

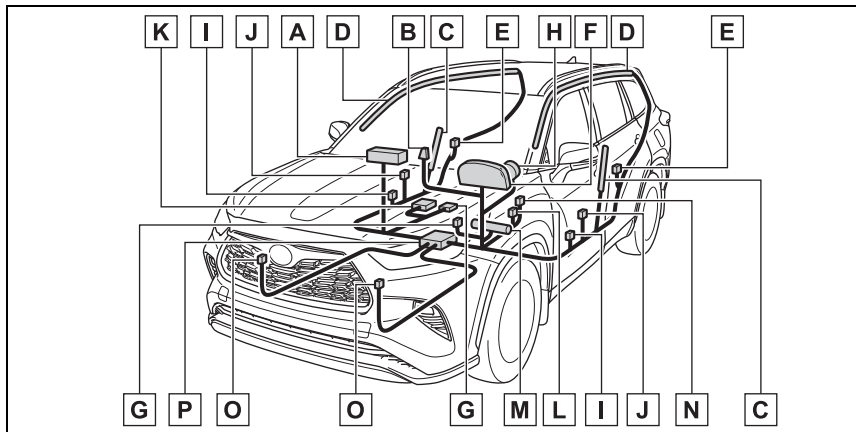

- A Front passenger airbag
- B "PASS AIR BAG ON" and "PASS AIR BAG OFF" indicator lights
- C Front side airbags
- D Curtain shield airbags
- E Side impact sensors (rear)
- F SRS warning light
- G Front passenger occupant classification system (ECU and sensors)
- H Driver airbag
- I Side impact sensors (front door)
- J Seat belt pretensioners and force limiters
- K Seat cushion airbag
- L Driver's seat position sensor
- M Driver's knee airbag
- N Driver's seat belt buckle switch
- O Front impact sensors
- P Airbag sensor assembly

Your vehicle is equipped with ADVANCED AIRBAGS designed based on the US motor vehicle safety standards (FMVSS208). The airbag sensor assembly (ECU) controls airbag deployment based on information obtained from the sensors etc. shown in the system components diagram above. This information includes crash severity and occupant information. As the airbags deploy, a chemical reaction in the inflators quickly fills the airbags with non-toxic gas to help restrain the motion of the occupants.

**■ If the SRS airbags deploy (inflate)**

- Slight abrasions, burns, bruising etc., may be sustained from SRS airbags, due to the extremely high speed deployment (inflation) by hot gases.
- A loud noise and white powder will be emitted.
- Parts of the airbag module (steering wheel hub, airbag cover and inflator) as well as the front seats, parts of the front and rear pillars, and roof side rails, may be hot for several minutes. The airbag itself may also be hot.
- The windshield may crack.
- All of the doors will be unlocked. (→P.116)
- The brakes and stop lights will be controlled automatically. (→P.314)
- The interior lights will turn on automatically. (→P.357)
- The emergency flashers will turn on automatically. (→P.442)
- Fuel supply to the engine will be stopped. (→P.449)
- For Safety Connect subscribers, if any of the following situations occur, the system is designed to send an emergency call to the response center, notifying them of the vehicle's location (without needing to push the "SOS" button) and an agent will attempt to speak with the occupants to ascertain the level of emergency and assistance required. If the occupants

are unable to communicate, the agent automatically treats the call as an emergency and helps to dispatch the necessary emergency services. (→P.63)

- An SRS airbag is deployed.
- A seat belt pretensioner is activated.
- The vehicle is involved in a severe rear-end collision.

**■ SRS airbag deployment conditions (SRS front airbags)**

- The SRS front airbags will deploy in the event of an impact that exceeds the set threshold level (the level of force corresponding to an approximately 12 - 18 mph [20 - 30 km/h] frontal collision with a fixed wall that does not move or deform).

However, this threshold velocity will be considerably higher in the following situations:

- If the vehicle strikes an object, such as a parked vehicle or sign pole, which can move or deform on impact
- If the vehicle is involved in an underride collision, such as a collision in which the front of the vehicle "underrides", or goes under, the bed of a truck
- Depending on the type of collision, it is possible that only the seat belt pretensioners will activate.
- The SRS front airbags for the front passenger will not activate if there is no passenger sitting in the front passenger seat. However, the SRS front airbags for the front

passenger may deploy if luggage is put in the seat, even if the seat is unoccupied.

- The SRS seat cushion airbag on the front passenger seat will not operate if the occupant is not wearing a seat belt.
- **SRS airbag deployment conditions (SRS side and curtain shield airbags)**
- The SRS side and curtain shield airbags will deploy in the event of an impact that exceeds the set threshold level (the level of force corresponding to the impact force produced by an approximately 3300 lb. [1500 kg] vehicle colliding with the vehicle cabin from a direction perpendicular to the vehicle orientation at an approximate speed of 12 - 18 mph [20 - 30 km/h]).
- Both SRS curtain shield airbags may deploy in the event of a severe side collision.
- Both SRS curtain shield airbags will deploy in the event of vehicle rollover.
- Both SRS curtain shield airbags may also deploy in the event of a severe frontal collision.
- **Conditions under which the SRS airbags may deploy (inflate), other than a collision**

The SRS front airbags and SRS curtain shield airbags may also deploy if a serious impact occurs to the underside of your vehicle. Some examples are shown in the illustration.

- Hitting a curb, edge of pavement or hard surface
- Falling into or jumping over a deep hole
- Landing hard or falling

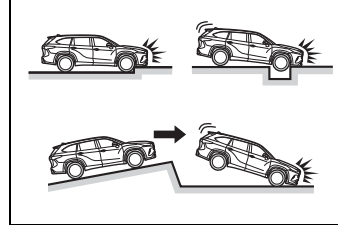

The SRS curtain shield airbags may also deploy under the situations shown in the illustration.

- The angle of vehicle tip-up is marginal.
- The vehicle skids and hits a curb stone.

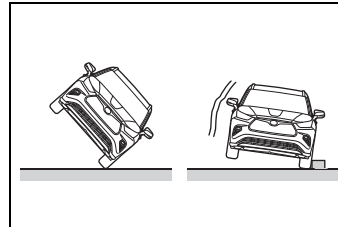

■ **Types of collisions that may not deploy the SRS airbags (SRS front airbags)**

The SRS front airbags do not generally inflate if the vehicle is involved in a side or rear collision, if it rolls over, or if it is involved in a low-speed frontal collision. But, whenever a collision of any type causes sufficient forward deceleration of the vehicle, deployment of the SRS front airbags may occur.

- Collision from the side
- Collision from the rear
- Vehicle rollover

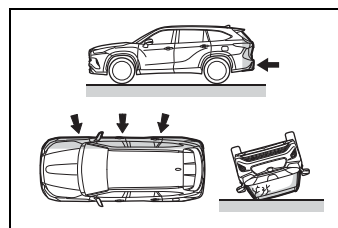

### ■ Types of collisions that may not deploy the SRS airbags (SRS side and curtain shield airbags)

The SRS side and curtain shield airbags may not activate if the vehicle is subjected to a collision from the side at certain angles, or a collision to the side of the vehicle body other than the passenger compartment.

- Collision from the side to the vehicle body other than the passenger compartment
- Collision from the side at an angle

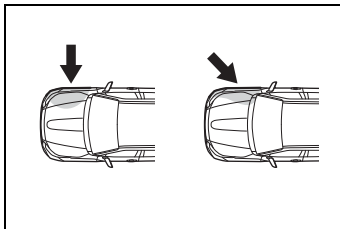

The SRS side airbags do not generally inflate if the vehicle is involved in a frontal or rear collision, if it rolls over, or if it is involved in a low-speed side collision.

- Collision from the front
- Collision from the rear
- Vehicle rollover

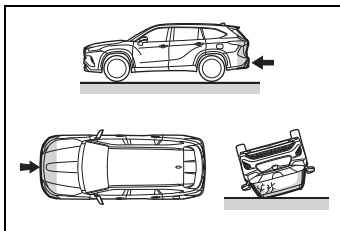

The SRS curtain shield airbags do not generally inflate if the vehicle is involved in a rear collision, if it pitches end over end, or if it is involved in a low-speed side or low-speed frontal collision.

- Collision from the rear
- Pitching end over end

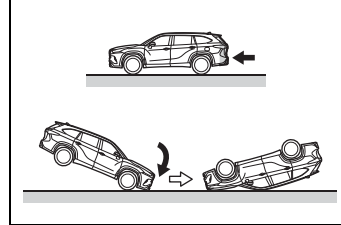

### ■ When to contact your Toyota dealer

In the following cases, the vehicle will require inspection and/or repair. Contact your Toyota dealer as soon as possible.

- Any of the SRS airbags have been inflated.
- The front of the vehicle is damaged or deformed, or was involved in an accident that was not severe enough to cause the SRS front airbags to inflate.

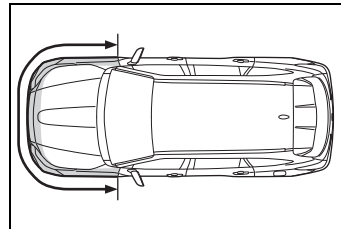

- A portion of a door or its surrounding area is damaged, deformed or has had a hole made in it, or the vehicle was involved in an accident that was not severe enough to cause the SRS side and curtain shield airbags to inflate.

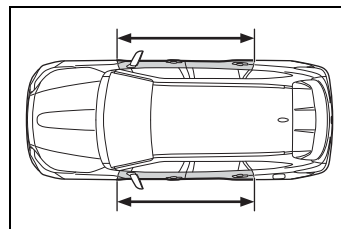

- The pad section of the steering wheel, dashboard near the front passenger airbag or lower portion of the instrument panel is

scratched, cracked, or otherwise damaged.

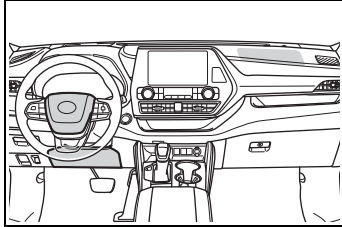

- The front passenger's seat cushion surface is scratched, cracked, or otherwise damaged.

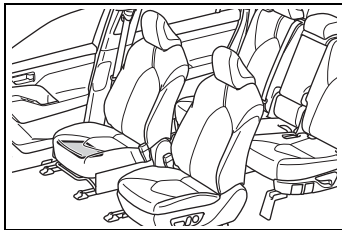

- The surface of the seats with the SRS side airbag is scratched, cracked, or otherwise damaged.

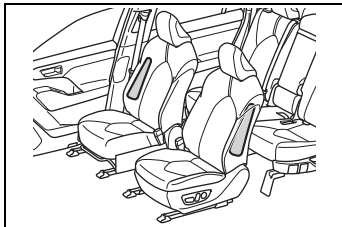

- The portion of the front pillars, rear pillars or roof side rail garnishes (padding) containing the SRS curtain shield airbags inside is scratched, cracked, or otherwise damaged.

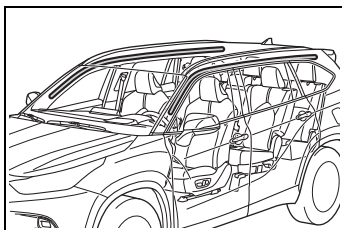

### ⚠ WARNING

#### ■ SRS airbag precautions

Observe the following precautions regarding the SRS airbags. Failure to do so may cause death or serious injury.

- The driver and all passengers in the vehicle must wear their seat belts properly. The SRS airbags are supplemental devices to be used with the seat belts.

- The SRS driver airbag deploys with considerable force, and can cause death or serious injury especially if the driver is very close to the airbag. The National Highway Traffic Safety Administration (NHTSA) advises:

Since the risk zone for the driver's airbag is the first 2 - 3 in. (50 - 75 mm) of inflation, placing yourself 10 in. (250 mm) from your driver airbag provides you with a clear margin of safety. This distance is measured from the center of the steering wheel to your breastbone. If you sit less than 10 in. (250 mm) away now, you can change your driving position in several ways:

- Move your seat to the rear as far as you can while still reaching the pedals comfortably.

**⚠ WARNING**

- Slightly recline the back of the seat.  
Although vehicle designs vary, many drivers can achieve the 10 in. (250 mm) distance, even with the driver seat all the way forward, simply by reclining the back of the seat somewhat. If reclining the back of your seat makes it hard to see the road, raise yourself by using a firm, non-slippery cushion, or raise the seat if your vehicle has that feature.
- If your steering wheel is adjustable, tilt it downward. This points the airbag toward your chest instead of your head and neck.

The seat should be adjusted as recommended by NHTSA above, while still maintaining control of the foot pedals, steering wheel, and your view of the instrument panel controls.

- If the seat belt extender has been connected to the front seat belt buckles but the seat belt extender has not also been fastened to the latch plate of the seat belt, the SRS front airbags will judge that the driver and front passenger are wearing the seat belt even though the seat belt has not been connected. In this case, the SRS front airbags may not activate correctly in a collision, resulting in death or serious injury in the event of a collision. Be sure to wear the seat belt with the seat belt extender.

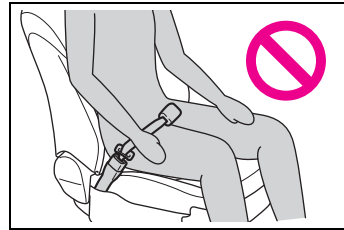

- The SRS front passenger airbag also deploys with considerable force, and can cause death or serious injury especially if the front passenger is very close to the airbag. The front passenger seat should be as far from the airbag as possible with the seat-back adjusted, so the front passenger sits upright.

**⚠ WARNING**

- Improperly seated and/or restrained infants and children can be killed or seriously injured by a deploying airbag. An infant or child who is too small to use a seat belt should be properly secured using a child restraint system. Toyota strongly recommends that all infants and children be placed in the rear seats of the vehicle and properly restrained. The rear seats are safer for infants and children than the front passenger seat. (→P.48)

- Do not sit on the edge of the seat or lean against the dashboard.

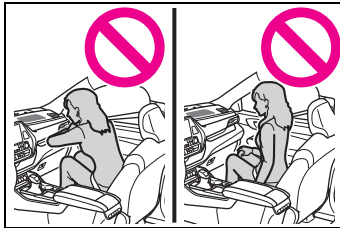

- Do not allow a child to stand in front of the SRS front passenger airbag unit or sit on the knees of a front passenger.

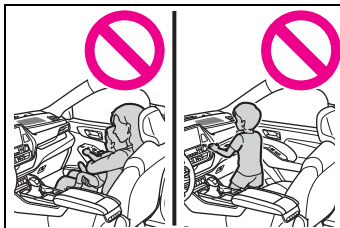

- Do not allow the front seat occupants to hold items on their knees.

- Do not lean against the door, the roof side rail or the front, side and rear pillars.

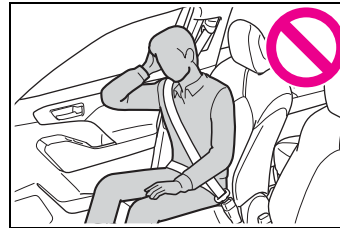

- Do not allow anyone to kneel on the passenger seat toward the door or put their head or hands outside the vehicle.

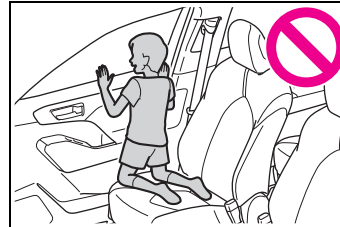

- Do not attach anything to or lean anything against areas such as the dashboard, steering wheel pad and lower portion of the instrument panel. These items can become projectiles when the SRS driver, front passenger and knee airbags deploy.

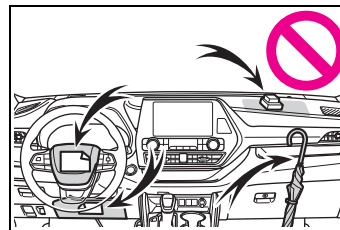

**⚠ WARNING**

- Do not attach anything to areas such as a door, windshield, side windows, front or rear pillar, roof side rail and assist grip.

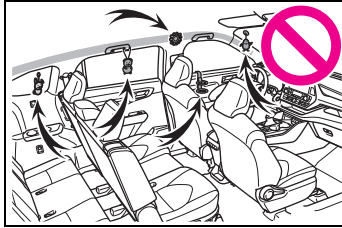

- Do not hang coat hangers or other hard objects on the coat hooks. All of these items could become projectiles and may cause death or serious injury, should the SRS curtain shield airbags deploy.
- If a vinyl cover is put on the area where the SRS knee airbag will deploy, be sure to remove it.
- Do not use seat accessories which cover the parts where the SRS side airbags and SRS seat cushion airbag inflate as they may interfere with inflation of the SRS airbags. Such accessories may prevent the side airbags and seat cushion airbag from activating correctly, disable the system or cause the side airbags and seat cushion airbag to inflate accidentally, resulting in death or serious injury.
- Do not strike or apply significant levels of force to the area of the SRS airbag components or the front doors. Doing so can cause the SRS airbags to malfunction.
- Do not touch any of the component parts immediately after the SRS airbags have deployed (inflated) as they may be hot.

- If breathing becomes difficult after the SRS airbags have deployed, open a door or window to allow fresh air in, or leave the vehicle if it is safe to do so. Wash off any residue as soon as possible to prevent skin irritation.

- If the areas where the SRS airbags are stored, such as the steering wheel pad and front and rear pillar garnishes, are damaged or cracked, have them replaced by your Toyota dealer.

- Do not place anything, such as a cushion, on the front passenger's seat. Doing so will disperse the passenger's weight, which prevents the sensor from detecting the passenger's weight properly. As a result, the SRS front airbags for the front passenger may not deploy in the event of a collision.

**■ Modification and disposal of SRS airbag system components**

Do not dispose of your vehicle or perform any of the following modifications without consulting your Toyota dealer. The SRS airbags may malfunction or deploy (inflate) accidentally, causing death or serious injury.

- Installation, removal, disassembly and repair of the SRS airbags
- Repairs, modifications, removal or replacement of the steering wheel, instrument panel, dashboard, seats or seat upholstery, front, side and rear pillars, roof side rails, front door panels, front door trims or front door speakers



**⚠ WARNING**

- Modifications to the front door panel (such as making a hole in it)
- Repairs or modifications of the front fender, front bumper, or side of the occupant compartment
- Installation of a grille guard (bull bars, kangaroo bar, etc.), snow plows, winches or roof luggage carrier
- Modifications to the vehicle's suspension system
- Installation of electronic devices such as mobile two-way radios and CD players
- Modifications to your vehicle for a person with a physical disability

**Front passenger occupant classification system**

Your vehicle is equipped with a front passenger occupant classification system. This system detects the conditions of the front passenger seat and activates or deactivates the front passenger airbag and seat cushion airbag.

**System components**

- ▶ Vehicles with a 8-inch display

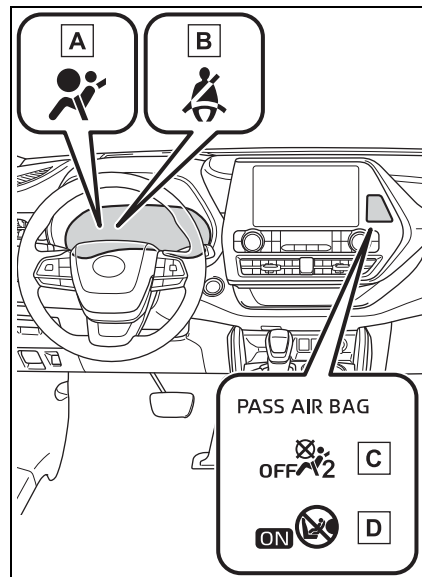

- A** SRS warning light
- B** Driver's and front passenger's seat belt reminder light
- C** "PASS AIR BAG OFF" indicator light

- D “PASS AIR BAG ON” indicator light
  - ▶ Vehicles with a 12.3-inch display



- A SRS warning light
- B Driver's and front passenger's seat belt reminder light
- C “PASS AIR BAG OFF” indicator light
- D “PASS AIR BAG ON” indicator light

**⚠ WARNING**

**■ Front passenger occupant classification system precautions**

Observe the following precautions regarding the front passenger occupant classification system. Failure to do so may cause death or serious injury.

- Wear the seat belt properly.

- Make sure the front passenger's seat belt plate has not been left inserted into the buckle before someone sits in the front passenger seat.

- Make sure the “PASS AIR BAG OFF” indicator light is not illuminated when using the seat belt extender for the front passenger seat. If the “PASS AIR BAG OFF” indicator light is illuminated, disconnect the extender tongue from the seat belt buckle, and reconnect the seat belt. Reconnect the seat belt extender after making sure the “PASS AIR BAG ON” indicator light is illuminated. If you use the seat belt extender while the “PASS AIR BAG OFF” indicator light is illuminated, the SRS airbags for the front passenger will not activate, which could cause death or serious injury in the event of a collision.

- Do not apply a heavy load to the front passenger seat or equipment (e.g. seatback pocket).

- Do not put weight on the front passenger seat by putting your hands or feet on the front passenger seat seatback from the rear passenger seat.

- Do not let a rear passenger lift the front passenger seat with their feet or press on the seatback with their legs.

- Do not put objects under the front passenger seat.

**WARNING**

- Do not recline the front passenger seatback so far that it touches a rear seat. This may cause the "PASS AIR BAG OFF" indicator light to be illuminated, which indicates that the SRS airbags for the front passenger will not activate in the event of a severe accident. If the seatback touches the rear seat, return the seatback to a position where it does not touch the rear seat. Keep the front passenger seatback as upright as possible when the vehicle is moving. Reclining the seatback excessively may lessen the effectiveness of the seat belt system.
  - If an adult sits in the front passenger seat, the "PASS AIR BAG ON" indicator light is illuminated. If the "PASS AIR BAG OFF" indicator is illuminated, ask the passenger to sit up straight, well back in the seat, feet on the floor, and with the seat belt worn correctly. If the "PASS AIR BAG OFF" indicator still remains illuminated, either ask the passenger to move to the rear seat, or if that is not possible, move the front passenger seat fully rearward.
  - When it is unavoidable to install a forward-facing child restraint system on the front passenger seat, install the child restraint system on the front passenger seat in the proper order. (→P.50)
  - Do not modify or remove the front seats.
- Do not kick the front passenger seat or subject it to severe impact. Otherwise, the SRS warning light may come on to indicate a malfunction of the front passenger occupant classification system. In this case, contact your Toyota dealer immediately.
  - Child restraint systems installed on the rear seat should not contact the front seatbacks.
  - Do not use a seat accessory, such as a cushion and seat cover, that covers the seat cushion surface.
  - Do not modify or replace the upholstery of the front seat.

**Condition and operation in the front passenger occupant classification system**

■ **Adult<sup>\*1</sup>**

Indicator/warning light	“PASS AIR BAG ON” and “PASS AIR BAG OFF” indicator lights	“PASS AIR BAG ON”
	SRS warning light	Off
	Driver’s and front passenger’s seat belt reminder light	Off <sup>*2</sup> or flashing <sup>*3</sup>
Devices	Front passenger airbag	Activated
	Front passenger seat cushion airbag	Activated <sup>*2</sup> or deactivated <sup>*3</sup>

■ **Child<sup>\*4</sup>**

Indicator/warning light	“PASS AIR BAG ON” and “PASS AIR BAG OFF” indicator lights	“PASS AIR BAG OFF” or “PASS AIR BAG ON” <sup>*4</sup>
	SRS warning light	Off
	Driver’s and front passenger’s seat belt reminder light	Off <sup>*2</sup> or flashing <sup>*3</sup>
Devices	Front passenger airbag	Deactivated or activated <sup>*4</sup>
	Front passenger seat cushion airbag	Deactivated or activated <sup>*4, 2</sup>

■ **Child restraint system with infant<sup>\*5</sup>**

Indicator/warning light	“PASS AIR BAG ON” and “PASS AIR BAG OFF” indicator lights	“PASS AIR BAG OFF” <sup>*6</sup>
	SRS warning light	Off
	Driver’s and front passenger’s seat belt reminder light	Off <sup>*2</sup> or flashing <sup>*3</sup>
Devices	Front passenger airbag	Deactivated
	Front passenger seat cushion airbag	

### ■ Unoccupied

Indicator/warning light	"PASS AIR BAG ON" and "PASS AIR BAG OFF" indicator lights	"PASS AIR BAG OFF"
	SRS warning light	Off
	Driver's and front passenger's seat belt reminder light	
Devices	Front passenger airbag	Deactivated
	Seat cushion airbag in the front passenger side	

### ■ There is a malfunction in the system

Indicator/warning light	"PASS AIR BAG ON" and "PASS AIR BAG OFF" indicator lights	"PASS AIR BAG OFF"
	SRS warning light	On
	Driver's and front passenger's seat belt reminder light	Off
Devices	Front passenger airbag	Deactivated
	Front passenger seat cushion airbag	

\*1: The system judges a person of adult size as an adult. When a smaller adult sits in the front passenger seat, the system may not recognize him/her as an adult depending on his/her physique and posture.

\*2: In the event the front passenger is wearing a seat belt.

\*3: In the event the front passenger does not wear a seat belt.

\*4: For some children, child in seat, child in booster seat or child in convertible seat, the system may not recognize him/her as a child. Factors which may affect this can be the physique or posture.

\*5: Never install a rear-facing child restraint system on the front passenger seat. A forward-facing child restraint system should only be installed on the front passenger seat when it is unavoidable. (→P.48)

\*6: In case the indicator light is not illuminated, consult this manual on how to install the child restraint system properly. (→P.50)

## Exhaust gas precautions

**Harmful substance to the human body is included in exhaust gases if inhaled.**

### WARNING

Exhaust gases include harmful carbon monoxide (CO), which is colorless and odorless. Observe the following precautions.

Failure to do so may cause exhaust gases enter the vehicle and may lead to an accident caused by light-headedness, or may lead to death or a serious health hazard.

#### ■ Important points while driving

- Keep the back door closed.
- If you smell exhaust gases in the vehicle even when the back door is closed, open the windows and have the vehicle inspected at your Toyota dealer as soon as possible.

#### ■ When parking

- If the vehicle is in a poorly ventilated area or a closed area, such as a garage, stop the engine.
- Do not leave the vehicle with the engine running for a long time.  
If such a situation cannot be avoided, park the vehicle in an open space and ensure that exhaust fumes do not enter the vehicle interior.

- Do not leave the engine running in an area with snow build-up, or where it is snowing. If snowbanks build up around the vehicle while the engine is running, exhaust gases may collect and enter the vehicle.

#### ■ Exhaust pipe

The exhaust system needs to be checked periodically. If there is a hole or crack caused by corrosion, damage to a joint or abnormal exhaust noise, be sure to have the vehicle inspected and repaired by your Toyota dealer.

**Riding with children**

**Observe the following precautions when children are in the vehicle.**

**Use a child restraint system appropriate for the child, until the child becomes large enough to properly wear the vehicle's seat belt.**

- It is recommended that children sit in the rear seats to avoid accidental contact with the shift lever, wiper switch, etc.
- Use the rear door child-protector lock or the window lock switch to avoid children opening the door while driving or operating the power window accidentally.  
(→P.118, 166)
- Do not let small children operate equipment which may catch or pinch body parts, such as the power window, hood, back door, seats etc.

 **WARNING****■ When children are in the vehicle**

Never leave children unattended in the vehicle, and never allow children to have or use the key.

Children may be able to start the vehicle or shift the vehicle into neutral. There is also a danger that children may injure themselves by playing with the windows, the moon roof or panoramic moon roof, or other features of the vehicle. In addition, heat build-up or extremely cold temperatures inside the vehicle can be fatal to children.

## Child restraint systems

**Before installing a child restraint system in the vehicle, there are precautions that need to be observed, different types of child restraint systems, as well as installation methods, etc., written in this manual.**

**Use a child restraint system when riding with a small child that cannot properly use a seat belt. For the child's safety, install the child restraint system to a second seat. Be sure to follow the installation method that is in the operation manual enclosed with the restraint system.**

## Table of contents

Points to remember: P.48

Child restraint system: P.50

When using a child restraint system: P.51

Child restraint system installation method

- Fixed with a seat belt: P.53
- Fixed with a child restraint LATCH anchor: P.58
- Using an anchor bracket (for top tether strap): P.60

## Points to remember

The laws of all 50 states of the U.S.A. as well as Canada now require the use of child restraint systems.

- Prioritize and observe the warnings, as well as the laws and regulations for child restraint systems.
- Use a child restraint system until the child becomes large enough to properly wear the vehicle's seat belt.
- Choose a child restraint system that suits your vehicle and is appropriate to the age and size of the child.

## WARNING

### ■ When a child is riding

Observe the following precautions.

Failure to do so may result in death or serious injury.

- For effective protection in automobile accidents and sudden stops, a child must be properly restrained, using a seat belt or child restraint system which is correctly installed. For installation details, refer to the operation manual enclosed with the child restraint system. General installation instruction is provided in this manual.



 **WARNING**

- Toyota strongly urges the use of a proper child restraint system that conforms to the weight and size of the child, installed on the second seat. According to accident statistics, the child is safer when properly restrained in the second seat than in the front seat.
  - Holding a child in your or someone else's arms is not a substitute for a child restraint system. In an accident, the child can be crushed against the windshield or between the holder and the interior of the vehicle.
- Handling the child restraint system**
- If the child restraint system is not properly fixed in place, the child or other passengers may be seriously injured or even killed in the event of sudden braking, sudden swerving, or an accident.
- If the vehicle were to receive a strong impact from an accident, etc., it is possible that the child restraint system has damage that is not readily visible. In such cases, do not reuse the restraint system.
  - Make sure you have complied with all installation instructions provided with the child restraint system manufacturer and that the system is properly secured.
  - Keep the child restraint system properly secured on the seat even if it is not in use. Do not store the child restraint system unsecured in the passenger compartment.

- If it is necessary to detach the child restraint system, remove it from the vehicle or store it securely in the luggage compartment.

**Child restraint system**

■ **Types of child restraint system installation methods**

Confirm with the operation manual enclosed with the child restraint system about the installation of the child restraint system.

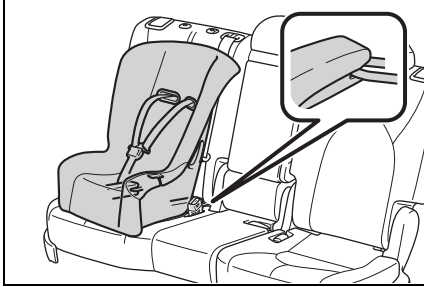
	Installation method	Page
Seat belt attachment		P.53
Child restraint LATCH anchors attachment		P.58

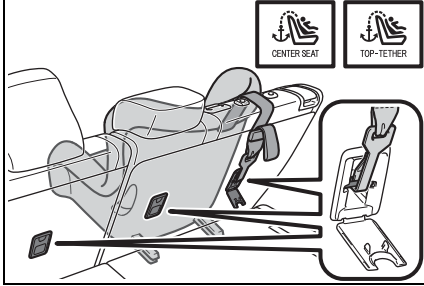
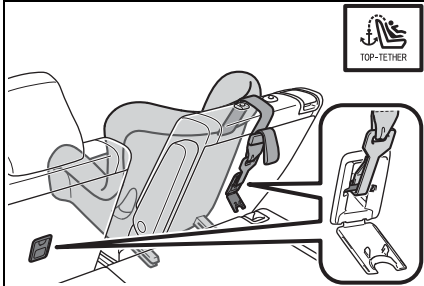
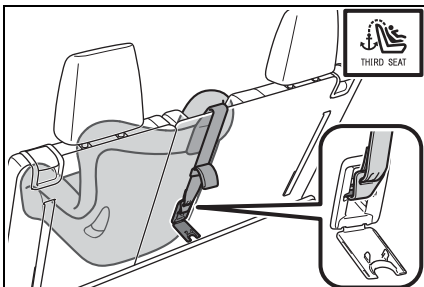
Installation method	Page
<p>Anchor brackets (for top tether strap) attachment</p>	<p>8-seat models second seats:</p>  <p>7-seat models second seats:</p>  <p>Third seats* :</p> 

P.60

\*: The third seats are not equipped with Child restraint LATCH anchors.

**When using a child restraint system**

- **When installing a child restraint system to a front passenger seat**

For the safety of a child, install child restraint systems to second seats. When installing child restraint system to a front passenger seat is unavoidable, adjust the seat as follows and install the child restraint system.

## 52 1-2. Child safety

- Move the seat to the rearmost position
- Raise the seatback as much as possible
- If the head restraint interferes with the installation of the child restraint system, and the head restraint can be removed, remove the head restraint

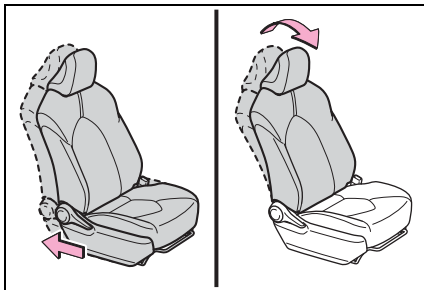

### WARNING

#### ■ When using a child restraint system

Observe the following precautions.

Failure to do so may result in death or serious injury.

- Never install a rear-facing child restraint system on the front passenger seat even if the "PASS AIR BAG OFF" indicator light is illuminated. In the event of an accident, the force of the rapid inflation of the front passenger airbag can cause death or serious injury to the child if the rear-facing child restraint system is installed on the front passenger seat.

- A forward-facing child restraint system may be installed on the front passenger seat only when it is unavoidable. A child restraint system that requires a top tether strap should not be used in the front passenger seat since there is no top tether strap anchor for the front passenger seat.

- A forward-facing child restraint system may be installed on the front passenger seat only when it is unavoidable. When installing a forward-facing child restraint system on the front passenger seat, raise the seatback as much as possible, and move the seat to the rearmost position, even if the "PASS AIR BAG OFF" indicator light is illuminated.

If the head restraint interferes with the installation of the child restraint system, and the head restraint can be removed, remove the head restraint.

If the head restraint cannot be removed, raise it to the uppermost position.

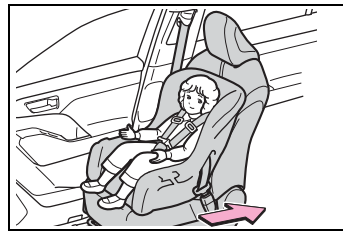

**⚠ WARNING**

- Do not allow the child to lean his/her head or any part of his/her body against the door or the area of the seat, front or rear pillars, or roof side rails from which the SRS side airbags or SRS curtain shield airbags deploy even if the child is seated in the child restraint system. It is dangerous if the SRS side airbags and curtain shield airbags inflate, and the impact could cause death or serious injury to the child.



- When a booster seat is installed, always ensure that the shoulder belt is positioned across the center of the child's shoulder. The belt should be kept away from the child's neck, but not so that it could fall off the child's shoulder.
- Use child restraint system suitable to the age and size of the child and install it to the rear seat.

- If the driver's seat interferes with the child restraint system and prevents it from being attached correctly, attach the child restraint system to the right-hand rear seat.

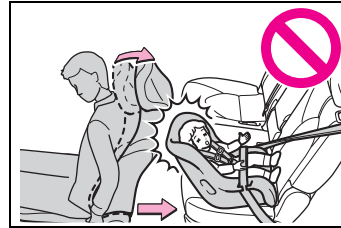

- Adjust the front passenger seat so that it does not interfere with the child restraint system.

**Child restraint system fixed with a seat belt**

A child restraint system for a small child or baby must itself be properly restrained on the seat with the lap portion of the lap/shoulder belt.

■ **Installing child restraint system using a seat belt (child restraint lock function belt)**

Install the child restraint system in accordance to the operation manual enclosed with the child restraint system.

■ **Rear-facing — Infant seat/convertible seat**

1 Adjust the rear seat

If there is a gap between the child seat and the seatback, adjust the seatback angle until good contact is achieved.

## 54 1-2. Child safety

- 2 Place the child restraint system on the rear seat facing the rear of the vehicle.

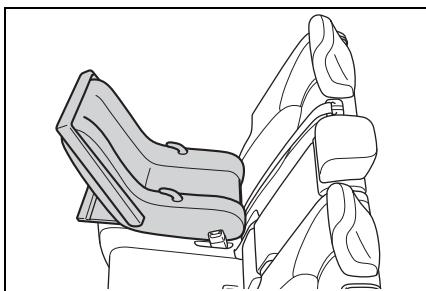

- 3 Run the seat belt through the child restraint system and insert the plate into the buckle. Make sure that the belt is not twisted.

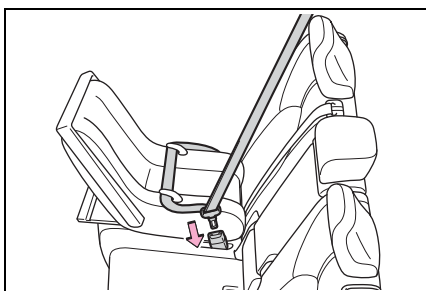

- 4 Fully extend the shoulder belt and allow it to retract to put it in lock mode. In lock mode, the belt cannot be extended.

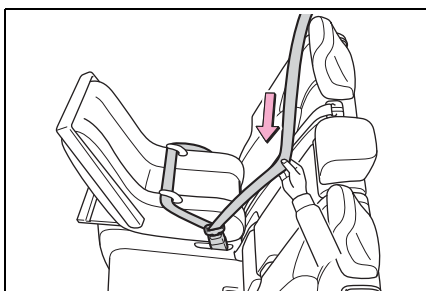

- 5 While pushing the child restraint system down into

the rear seat, allow the shoulder belt to retract until the child restraint system is securely in place.

After the shoulder belt has retracted to a point where there is no slack in the belt, pull the belt to check that it cannot be extended.

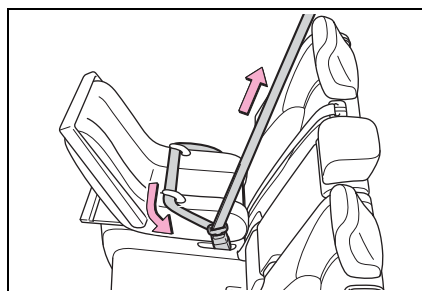

- 6 After installing the child restraint system, rock it back and forth to ensure that it is installed securely. (→P.57)

### ■ Forward-facing — Convertible seat

- 1 Adjust the seat

- ▶ When using the front passenger seat

If installing the child restraint system to the front passenger seat is unavoidable, refer to P.51 for the front passenger seat adjustment.

- ▶ When using the rear seat

If there is a gap between the child seat and the seatback, adjust the seatback angle until good contact is achieved.

- 2** Remove the head restraint if it interferes with your child restraint system. (→P.147)

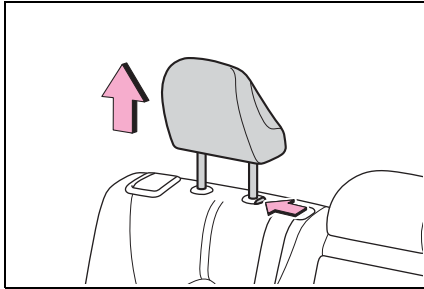

- 3** Place the child restraint system on the seat facing the front of the vehicle.

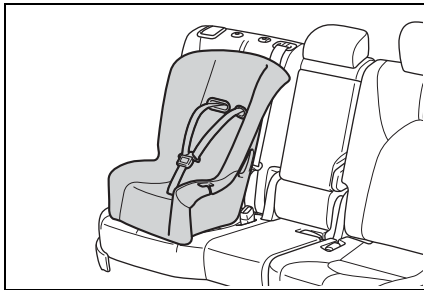

- 4** Run the seat belt through the child restraint system and insert the plate into the buckle. Make sure that the belt is not twisted.



- 5** Fully extend the shoulder belt and allow it to retract to put it

in lock mode. In lock mode, the belt cannot be extended.

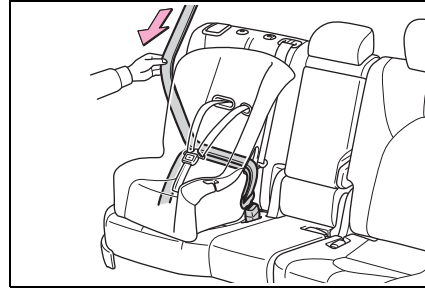

- 6** While pushing the child restraint system into the rear seat, allow the shoulder belt to retract until the child restraint system is securely in place.

After the shoulder belt has retracted to a point where there is no slack in the belt, pull the belt to check that it cannot be extended.

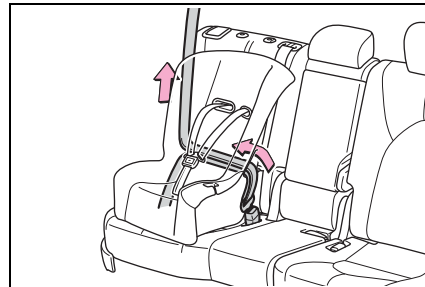

- 7** If the child restraint has a top tether strap, follow the child restraint manufacturer's operation manual regarding the installation, using the top tether strap to latch onto the top tether strap anchor. (→P.60)

- 8** After installing the child restraint system, rock it back

and forth to ensure that it is installed securely. (→P.57)

■ **Booster seat**

- 1 If installing the child restraint system to the front passenger seat is unavoidable, refer to P.51 for the front passenger seat adjustment.
- 2 High back type: Remove the head restraint if it interferes with your child restraint system. (→P.147)

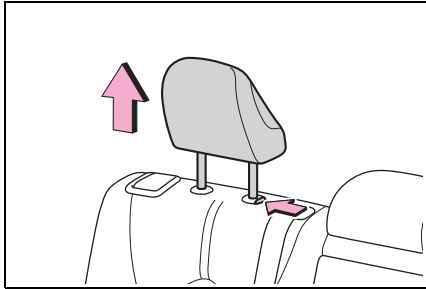

- 3 Place the child restraint system on the seat facing the front of the vehicle.

► **Booster type**

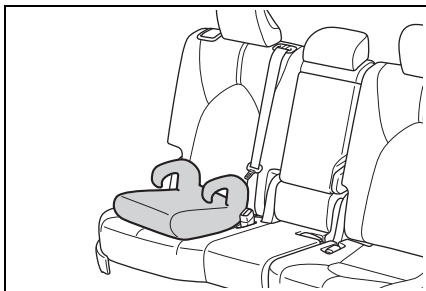

► **High back type**

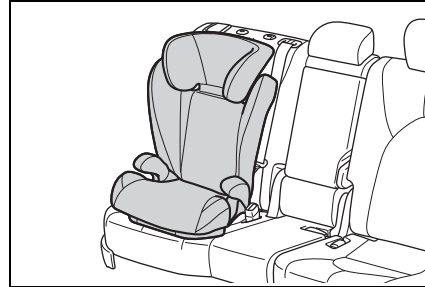

- 4 Sit the child in the child restraint system. Fit the seat belt to the child restraint system according to the manufacturer's instructions and insert the plate into the buckle. Make sure that the belt is not twisted.

Check that the shoulder belt is correctly positioned over the child's shoulder and that the lap belt is as low as possible. (→P.25)



■ **Removing a child restraint system installed with a seat belt**

Press the buckle release button and fully retract the seat belt.

When releasing the buckle, the child restraint system may spring up due to the rebound of the seat cushion. Release the buckle while holding down the child restraint



system.

Since the seat belt automatically reels itself, slowly return it to the stowing position.

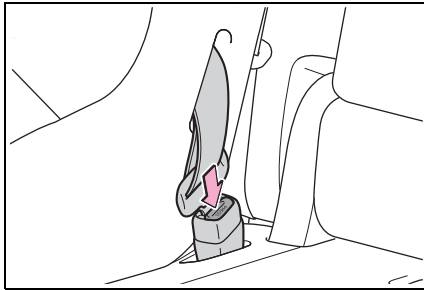

**⚠ WARNING**

**■ When installing a child restraint system**

Observe the following precautions. Failure to do so may result in death or serious injury.

- Do not allow children to play with the seat belt. If the seat belt becomes twisted around a child's neck, it may lead to choking or other serious injuries that could result in death. If this occurs and the buckle cannot be unfastened, scissors should be used to cut the belt.
- Ensure that the belt and plate are securely locked and the seat belt is not twisted.
- Shake the child restraint system left and right, and forward and backward to ensure that it has been securely installed.
- After securing a child restraint system, never adjust the seat.

- When a booster seat is installed, always ensure that the shoulder belt is positioned across the center of the child's shoulder. The belt should be kept away from the child's neck, but not so that it could fall off the child's shoulder.

- Follow all installation instructions provided by the child restraint system manufacturer.
- Child restraint systems cannot be installed in the rear center seat. Do not install the child restraint system in the rear center seat using the LATCH anchors.

- When securing some types of child restraint systems in rear seats, it may not be possible to properly use the seat belts in positions next to the child restraint without interfering with it or affecting seat belt effectiveness. Be sure your seat belt fits snugly across your shoulder and low on your hips. If it does not, or if it interferes with the child restraint, move to a different position. Failure to do so may result in death or serious injury.

**■ When installing a booster seat**

To prevent the belt from going into ALR lock mode, do not fully extend the shoulder belt. ALR mode causes the belt to tighten only. This could cause injury or discomfort to the child. (→P.26)

**⚠ WARNING**

**■ Do not use a seat belt extender**

If a seat belt extender is used when installing a child restraint system, the seat belt will not securely hold the child restraint system, which could cause death or serious injury to the child or other passengers in the event of sudden braking, sudden swerving or an accident.

**Child restraint system fixed with a child restraint LATCH anchor**

**■ Child restraint LATCH anchors**

LATCH anchors are provided for the outboard second seats.

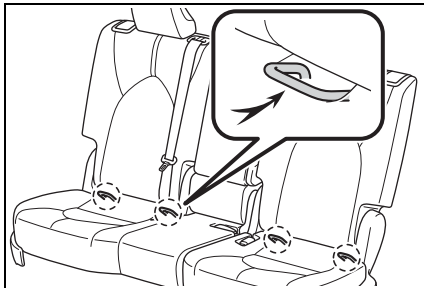

**■ When installing in the rear outboard seats**

Install the child restraint system in accordance to the operation manual enclosed with the child restraint system.

**1 Adjust the seat**

If there is a gap between the child seat and the seatback, adjust the seatback angle until good contact is achieved.

- 2** Remove the head restraint if it interferes with your child restraint system. (→P.147)

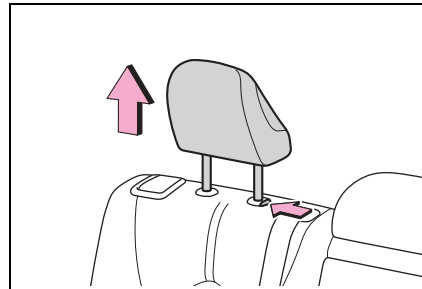

- 3** Widen the gap between the seat cushion and seatback slightly.

- ▶ With flexible lower attachments

- 4** Latch the hooks of the lower attachments onto the LATCH anchors.

For owners in Canada:

The symbol on a child restraint system indicates **A** the presence of a lower connector system.

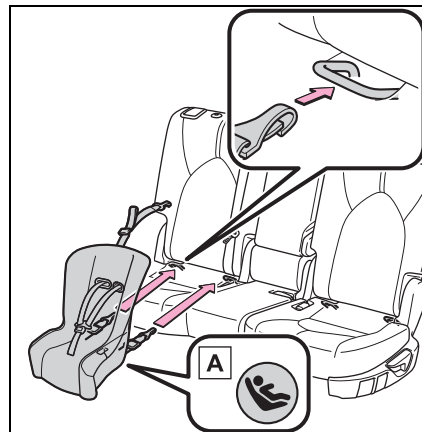

**A** Canada only

- ▶ With rigid lower attachments
- 4** Latch the buckles onto the LATCH anchors.  
For owners in Canada:  
The symbol on a child restraint system indicates **A** the presence of a lower connector system.

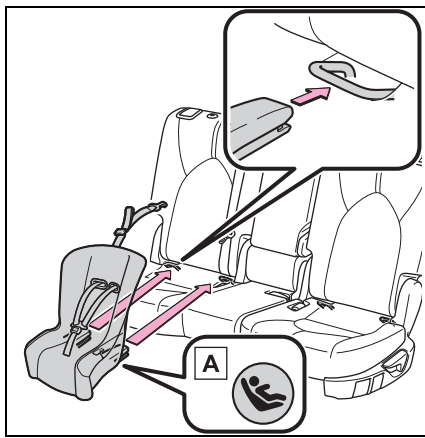

**A** Canada only

- 5** If the child restraint has a top tether strap, follow the child restraint manufacturer's operation manual regarding the installation, using the top tether strap to latch onto the top tether strap anchor. (→P.60)
  - 6** After installing the child restraint system, rock it back and forth to ensure that it is installed securely. (→P.57)
- **When installing in the second center seat (8-seat models)**

There are no LATCH anchors behind the second center seat.

However, the inboard LATCH anchors of the outboard seats, which are 18.6 in. (473 mm) apart, can be used if the child restraint system manufacturer's instructions permit use of those anchors with the anchor spacing stated.

Child restraint systems with rigid lower attachments cannot be installed in the center seat. This type of child restraint system can only be installed in the outboard seat.

■ **Laws and regulations pertaining to anchors**

The LATCH system conforms to FMVSS225 or CMVSS210.2. Child restraint systems conforming to FMVSS213 or CMVSS213 specifications can be used. This vehicle is designed to conform to SAE J1819.

**WARNING**

■ **When installing a child restraint system**

Observe the following precautions. Failure to do so may result in death or serious injury.

- After securing a child restraint system, never adjust the seat.
- When using the LATCH anchors, be sure that there are no foreign objects around the anchors and that the seat belt is not caught behind the child restraint system.
- Follow all installation instructions provided by the child restraint system manufacturer.

**⚠ WARNING**

- Never attach two child restraint system attachments to the same anchor. In a collision, one anchor may not be strong enough to hold two child restraint system attachments and may break.

If the LATCH anchors are already in use, use the seat belt to install a child restraint system in the center seat.

- When securing some types of child restraint systems in rear seats, it may not be possible to properly use the seat belts in positions next to the child restraint without interfering with it or affecting seat belt effectiveness. Be sure your seat belt fits snugly across your shoulder and low on your hips. If it does not, or if it interferes with the child restraint, move to a different position. Failure to do so may result in death or serious injury.
- If the seat is adjusted, reconfirm the security of the child restraint system.

**Using an anchor bracket (for top tether strap)**

■ **Anchor brackets (for top tether strap)**

Anchor brackets are provided for the following seats:

Use anchor brackets when fixing the top tether strap.

▶ 8-seat models second seats

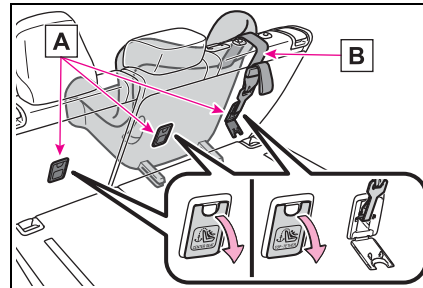

A Anchor brackets

B Top tether strap

▶ 7-seat models second seats

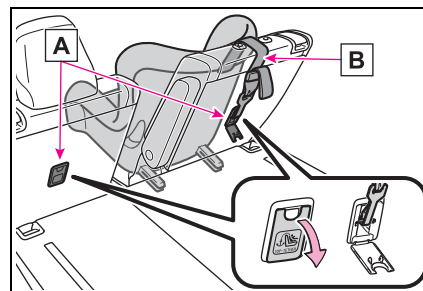

A Anchor brackets

B Top tether strap

▶ Third center seat\*

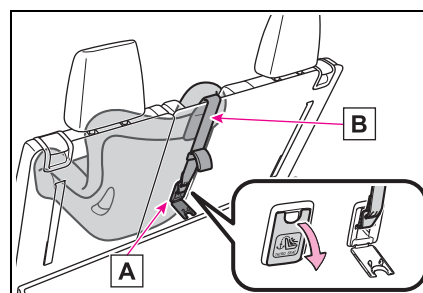

A Anchor brackets

B Top tether strap

\*: The third seats are not equipped with Child restraint LATCH

anchors.

■ **Fixing the top tether strap to the anchor bracket (second seats)**

Install the child restraint system in accordance to the operation manual enclosed with the child restraint system.

- 1 Remove the head restraint if it interferes with your child restraint system. (→P.147)

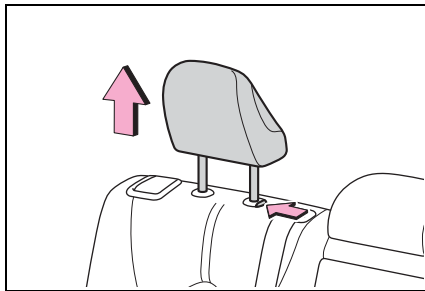

- 2 Open the anchor bracket cover, latch the hook onto the anchor bracket and tighten the top tether strap.

Make sure the top tether strap is securely latched. (→P.57)  
When installing the child restraint system with the head restraint being raised, be sure to have the top tether strap pass underneath the head restraint.

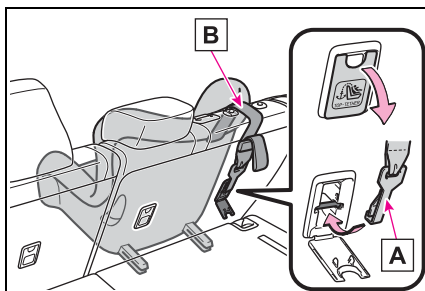

A Hook

B Top tether strap

■ **Fixing the top tether strap to the anchor bracket (third center seat)**

Install the child restraint system in accordance to the operation manual enclosed with the child restraint system.

- 1 Remove the head restraint if it interferes with your child restraint system. (→P.147)

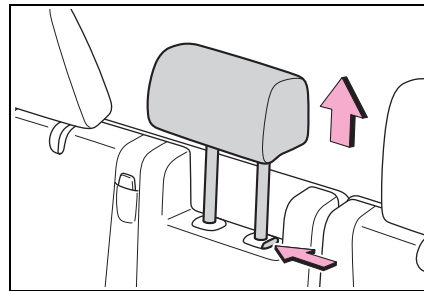

- 2 Latch the hook onto the anchor bracket and tighten the top tether strap.

Make sure the top tether strap is securely latched. (→P.57)  
When installing the child restraint system with the head restraint being raised, be sure to have the top tether strap pass underneath the head restraint.

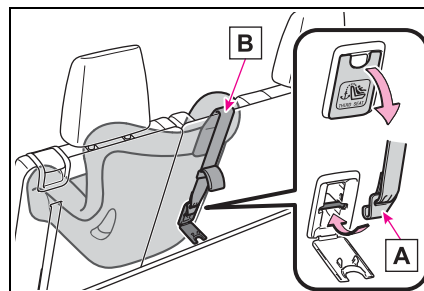

A Hook

B Top tether strap

■ **Laws and regulations pertaining to anchors**

The LATCH system conforms to FMVSS225 or CMVSS210.2. Child restraint systems conforming to FMVSS213 or CMVSS213 specifications can be used. This vehicle is designed to conform to SAE J1819.

 **WARNING**

■ **When installing a child restraint system**

Observe the following precautions. Failure to do so may result in death or serious injury.

- Firmly attach the top tether strap and make sure that the belt is not twisted.
- Do not attach the top strap to anything other than the anchor bracket of the seat the child restraint system is installed to.
- Follow all installation instructions provided by the child restraint system manufacturer.
- When installing a child restraint system in the center rear seat, adjust both seatbacks at the same angle. Otherwise, the child restraint system cannot be securely restrained and this may cause death or serious injuries in the event of sudden braking, sudden swerving or an accident.
- When installing the child restraint system with the head restraint being raised, after the head restraint has been raised and then the anchor bracket has been fixed, do not lower the head restraint.

- If the seat is adjusted, reconfirm the security of the child restraint system.

 **NOTICE**

■ **Anchor brackets (for top tether strap)**

When not in use, make certain to close the lid. If it remains open, the lid may be damaged.

## Safety Connect\*

\*: If equipped

**Safety Connect is a subscription-based telematics service that uses Global Positioning System (GPS) data and embedded cellular technology to provide safety and security features to subscribers. Safety Connect is supported by Toyota's designated response center, which operates 24 hours per day, 7 days per week.**

**Safety Connect service is available by subscription on select, telematics hardware-equipped vehicles.**

**By using the Safety Connect service, you are agreeing to be bound by the Telematics Subscription Service Agreement and its Terms and Conditions, as in effect and amended from time to time, a current copy of which is available at [Toyota.com](http://Toyota.com) in the United States, [Toyota.com](http://Toyota.com) in Puerto Rico and [Toyota.ca](http://Toyota.ca) in Canada. All use of the Safety Connect service is subject to such then-applicable Terms and Conditions.**

## System components

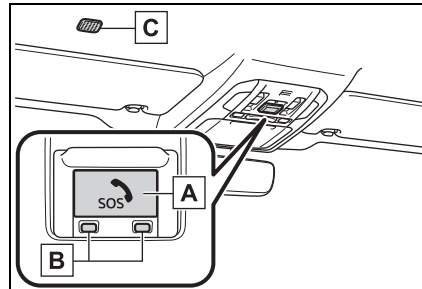

- A "SOS" button
- B LED light indicators
- C Microphone

■ Certification for Safety Connect

FCC ID: JOYDA39  
IC: 574B-DA39

**FCC/IC WARNING:**

Changes or modifications not expressly approved by the manufacture could void the user's authority to operate the equipment. This device complies with Part 15 of the FCC Rules and Industry Canada license-exempt RSS standards. Operation is subject to the following two conditions:  
(1) this device may not cause harmful interference, and  
(2) this device must accept any interference, including interference that may cause undesired operation of the device.  
This equipment complies with IC RSS-102 radiation exposure limits set forth for uncontrolled environment.  
The antennas used for this transmitter must be installed to provide a separation distance of least 20cm from all persons.

**FCC/IC AVERTISSEMENT:**

L'utilisateur est averti que les changements ou modifications non expressément approuvés par le fabricant pourraient annuler l'autorité de l'utilisateur à utiliser l'équipement.  
Ce appareil est compatible avec la Partie 15 du règlement FCC et de la Licence de l'industrie canadienne et des normes exemptes de RSS.  
Opération soumise aux deux conditions suivantes :  
(1) ce appareil ne doit pas causer des interférences nuisibles, et  
(2) cet appareil doit accepté toutes les interférences, y compris les interférences qui peuvent entraîner un fonctionnement indésirable de l'appareil.  
Cet appareil est compatible aux limites d'exposition aux radiation IC RSS-102 définies pour un environnement non contrôlé.  
Les antennes utilisées pour cet émetteur doivent être installées à une distance d'au moins 20 cm de toutes les personnes.

**Services**

Subscribers have the following Safety Connect services available:

- Automatic Collision Notification\*  
Helps drivers receive necessary response from emergency service providers. (→P.66)



\*: U.S. Patent No. 7,508,298 B2

- **Stolen Vehicle Location**

Helps drivers in the event of vehicle theft. (→P.66)

- **Emergency Assistance Button (“SOS”)**

Connects drivers to response-center support. (→P.67)

- **Enhanced Roadside Assistance**

Provides drivers various on-road assistance. (→P.67)

### Subscription

After you have signed the Telematics Subscription Service Agreement and are enrolled, you can begin receiving services.

A variety of subscription terms are available for purchase. Contact your Toyota dealer, call the following appropriate Customer Experience Center or push the “SOS” button in your vehicle for further subscription details.

- **The United States**

1-800-331-4331

- **Canada**

1-888-869-6828

- **Puerto Rico**

1-877-855-8377

#### ■ **Safety Connect Services Information**

- Phone calls using the vehicle’s Bluetooth® technology will not be

possible when Safety Connect is active and in use.

- Safety Connect is available beginning Fall 2009 on select Toyota models (in the contiguous United States only). Contact with the Safety Connect response center is dependent upon the telematics device being in operative condition, cellular connection availability, and GPS satellite signal reception, which can limit the ability to reach the response center or receive emergency service support. Enrollment and Telematics Subscription Service Agreement are required. A variety of subscription terms are available; charges vary by subscription term selected and location.

- Automatic Collision Notification, Emergency Assistance and Stolen Vehicle Location are available in the United States, including Hawaii and Alaska, Puerto Rico and Canada, and Enhanced Roadside Assistance are available in the United States, Puerto Rico and Canada.

- Automatic Collision Notification, Emergency Assistance, Stolen Vehicle and Enhanced Road Assistance are not available in the U.S. Virgin Islands. For vehicles first sold in the U.S. Virgin Islands, no Safety Connect services will function in or outside the U.S. Virgin Islands.

- Safety Connect services are not subject to section 255 of the Telecommunications Act and the device is not TTY compatible.

#### ■ **Languages**

The Safety Connect response center will offer support in multiple languages. The Safety Connect system will offer voice prompts in English, Spanish, and French. Please indicate your language of choice when enrolling.

■ **When contacting the response center**

You may be unable to contact the response center if the network is busy.

**Safety Connect LED light Indicators**

When the engine switch is turned to ON, the red indicator light comes on for 2 seconds then turns off. Afterward, the green indicator light comes on, indicating that the service is active.

The following indicator light patterns indicate specific system usage conditions:

- Green indicator light on = Active service
- Green indicator light flashing = Safety Connect call in process
- Red indicator light (except at vehicle start-up) = System malfunction (contact your Toyota dealer)
- No indicator light (off) = Safety Connect service not active

**Safety Connect services**

■ **Automatic Collision Notification**

In case of either airbag deployment or severe rear-end collision, the system is designed to

automatically call the response center. The responding agent receives the vehicle's location and attempts to speak with the vehicle occupants to assess the level of emergency. If the occupants are unable to communicate, the agent automatically treats the call as an emergency, contacts the nearest emergency services provider to describe the situation, and requests that assistance be sent to the location.

■ **Stolen Vehicle Location**

If your vehicle is stolen, Safety Connect can work with local authorities to assist them in locating and recovering the vehicle. After filing a police report, call the Customer Experience Center at 1-800-331-4331 in the United States, 1-877-855-8377 in Puerto Rico or 1-888-869-6828 in Canada, and follow the prompts for Safety Connect to initiate this service.

In addition to assisting law enforcement with recovery of a stolen vehicle, Safety-Connect-equipped vehicle location data may, under certain circumstances, be shared with third parties to locate your vehicle. Further information is available at Toyota.com in the United States, Toyotapr.com in Puerto Rico and Toyota.ca in Canada.

### ■ Emergency Assistance Button (“SOS”)

In the event of an emergency on the road, push the “SOS” button to reach the Safety Connect response center. The answering agent will determine your vehicle’s location, assess the emergency, and dispatch the necessary assistance required.

If you accidentally press the “SOS” button, tell the response-center agent that you are not experiencing an emergency.

### ■ Enhanced Roadside Assistance

Enhanced Roadside Assistance adds GPS data to the already included warranty-based Toyota roadside service.

Subscribers can press the “SOS” button to reach a Safety Connect response-center agent, who can help with a wide range of needs, such as: towing, flat tire, fuel delivery, etc. For a description of the Enhanced Roadside Assistance services and their limitations, please see the Safety Connect Terms and Conditions, which are available at [Toyota.com](http://Toyota.com) in the United States, [Toyotapr.com](http://Toyotapr.com) in Puerto Rico and [Toyota.ca](http://Toyota.ca) in Canada.

### Safety information for Safety Connect

Important! Read this informa-

tion before using Safety Connect.

### ■ Exposure to radio frequency signals

The Safety Connect system installed in your vehicle is a low-power radio transmitter and receiver. It receives and also sends out radio frequency (RF) signals.

In August 1996, the Federal Communications Commission (FCC) adopted RF exposure guidelines with safety levels for mobile wireless phones. Those guidelines are consistent with the safety standards previously set by the following U.S. and international standards bodies.

- ANSI (American National Standards Institute) C95.1 [1992]
- NCRP (National Council on Radiation Protection and Measurement) Report 86 [1986]
- ICNIRP (International Commission on Non-Ionizing Radiation Protection) [1996]

Those standards were based on comprehensive and periodic evaluations of the relevant scientific literature. Over 120 scientists, engineers, and physicians from universities, and government health agencies and industries reviewed the available body of research to

**68**      **1-3. Emergency assistance**

---

develop the ANSI Standard (C95.1).

The design of Safety Connect complies with the FCC guidelines in addition to those standards.

### Engine immobilizer system

The vehicle's keys have built-in transponder chips that prevent the engine from starting if a key has not been previously registered in the vehicle's on-board computer.

Never leave the keys inside the vehicle when you leave the vehicle.

This system is designed to help prevent vehicle theft but does not guarantee absolute security against all vehicle thefts.

### Operating the system

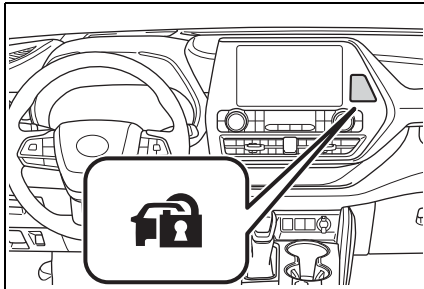

The indicator light flashes after the engine switch has been turned off to indicate that the system is operating.

The indicator light stops flashing after the engine switch has been turned to ACC or ON to indicate that the system has been canceled.

### System maintenance

The vehicle has a maintenance-free type engine immobilizer system.

### Conditions that may cause the system to malfunction

- If the grip portion of the key is in contact with a metallic object
- If the key is in close proximity to or touching a key registered to the security system (key with a built-in transponder chip) of another vehicle

## 70 1-4. Theft deterrent system

---

### ■ Certification for the engine immobilizer system

- ▶ Except for vehicles sold in Canada

FCC ID: NI4TMIMB-3

This device complies with part 15 of the FCC Rules. Operation is subject to the following two conditions: (1) This device may not cause harmful interference, and (2) this device must accept any interference received, including interference that may cause undesired operation.

Changes or modifications not expressly approved by the party responsible for compliance could void the user's authority to operate the equipment.

- ▶ For vehicles sold in Canada

This device complies with Industry Canada's licence-exempt RSSs. Operation is subject to the following two conditions: (1) This device may not cause interference; and (2) This device must accept any interference, including interference that may cause undesired operation of the device.

Le présent appareil est conforme aux CNR d'Industrie Canada applicables aux appareils radio exempts de licence. L'exploitation est autorisée aux deux conditions suivantes : 1) l'appareil ne doit pas produire de brouillage; 2) l'utilisateur de l'appareil doit accepter tout brouillage radioélectrique subi, même si le brouillage est susceptible d'en compromettre le fonctionnement.



#### NOTICE

#### ■ To ensure the system operates correctly

Do not modify or remove the system. If modified or removed, the proper operation of the system cannot be guaranteed.

## Alarm\*

\*: If equipped

**The alarm uses light and sound to give an alert when an intrusion is detected. The alarm is triggered in the following situations when the alarm is set:**

- A locked door is unlocked or opened in any way other than using the entry function, wireless remote control or mechanical key. (The doors will lock again automatically.)
- The hood is opened.

## Setting/canceling/stopping the alarm system

### ■ Items to check before locking the vehicle

To prevent unexpected triggering of the alarm and vehicle theft, make sure of the following:

- Nobody is in the vehicle.
- The windows, moon roof (if equipped) and panoramic moon roof (if equipped) are closed before the alarm is set.
- No valuables or other personal items are left in the vehicle.

### ■ Setting

Close the doors and hood, and lock all the doors. The system

will be set automatically after 30 seconds.

The security indicator changes from being on to flashing when the system is set.

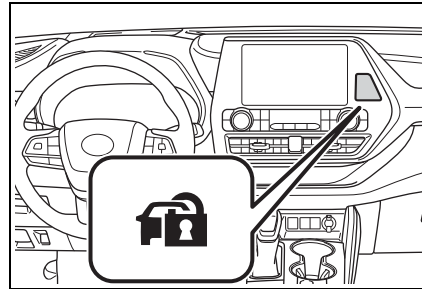

### ■ Canceling or stopping

Do one of the following to deactivate or stop the alarms:

- Unlock the doors.
- Turn the engine switch to ACC or ON, or start the engine. (The alarm will be deactivated or stopped after a few seconds.)

### ■ System maintenance

The vehicle has a maintenance-free type alarm system.

### ■ Triggering of the alarm

The alarm may be triggered in the following situations: (Stopping the alarm deactivates the alarm system.)

- A person inside the vehicle opens a door or hood, or unlocks the vehicle.

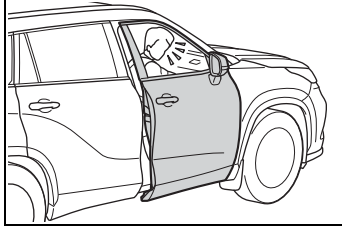

- The battery is recharged or replaced when the vehicle is locked. (→P.485)

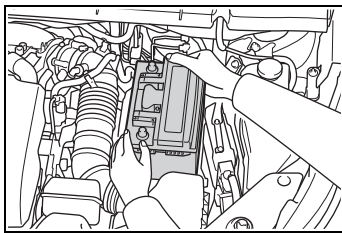

■ **Alarm-operated door lock**

In the following cases, depending on the situation, the door may automatically lock to prevent improper entry into the vehicle:

- When a person remaining in the vehicle unlocks the door and the alarm is activated.
- While the alarm is activated, a person remaining in the vehicle unlocks the door.
- When recharging or replacing the battery



**NOTICE**

■ **To ensure the system operates correctly**

Do not modify or remove the system. If modified or removed, the proper operation of the system cannot be guaranteed.



## Vehicle status information and indicators

2

73

### 2-1. Instrument cluster

- Warning lights and indicators ..... 74
- Gauges and meters ..... 79
- Multi-information display (4.2-inch display) ..... 82
- Multi-information display (7-inch display) ..... 91
- Head-up display ..... 101
- Fuel consumption information ..... 106

2

Vehicle status information and indicators

### Warning lights and indicators

The warning lights and indicators on the instrument cluster, center panel and outside rear view mirrors inform the driver of the status of the vehicle's various systems.

### Warning lights and indicators displayed on the instrument cluster

For the purpose of explanation, the following illustrations display all warning lights and indicators illuminated.

► 4.2-inch display

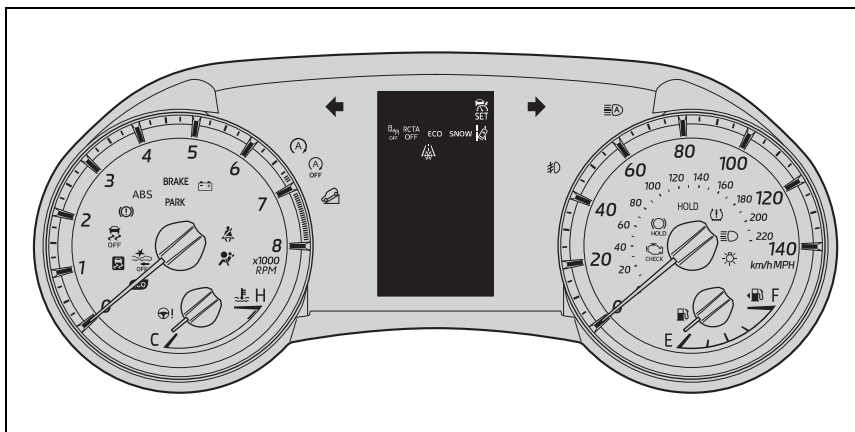

The units used on the meters and some indicators may differ depending on the target region.

► 7-inch display

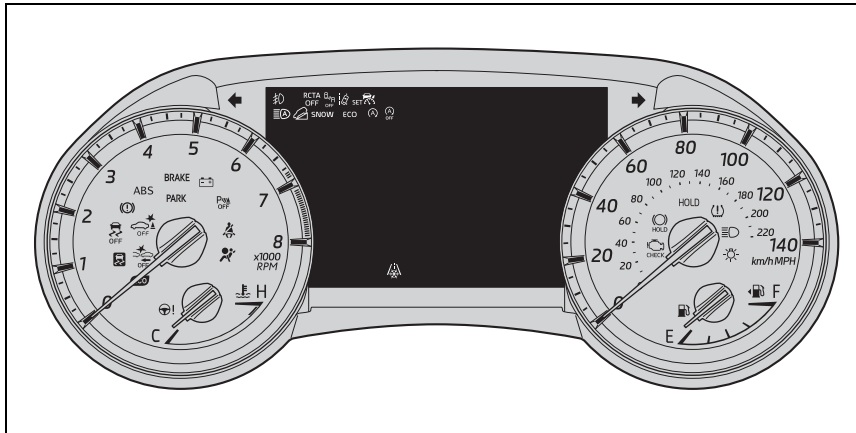







The units used on the meters and some indicators may differ depending on the target region.







2

Vehicle status information and indicators

**Warning lights**

Warning lights inform the driver of malfunctions in the indicated vehicle's systems.

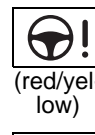
-  Brake system warning light\*<sup>1</sup> (→P.450)  
(U.S.A.)
-  Brake system warning light\*<sup>1</sup> (→P.450)  
(red)  
(Canada)
-  Brake system warning light\*<sup>1</sup> (→P.450)  
(yellow)
-  High coolant temperature warning light\*<sup>2</sup> (→P.450)
-  Charging system warning light\*<sup>1</sup> (→P.451)
-  Low engine oil pressure warning light\*<sup>2</sup> (→P.451)
-  Malfunction indicator lamp\*<sup>1</sup> (→P.451)  
(U.S.A.)

-  Malfunction indicator lamp\*<sup>1</sup> (→P.451)  
(Canada)
-  SRS warning light\*<sup>1</sup> (→P.451)
-  ABS warning light\*<sup>1</sup> (→P.452)  
(U.S.A.)
-  ABS warning light\*<sup>1</sup> (→P.452)  
(Canada)
-  Brake Override System warning light/Drive-Start control warning light\*<sup>2</sup> (→P.452)
-  Electric power steering system warning light (→P.452)  
(red/yellow)
-  Low fuel level warning light\*<sup>1</sup>(→P.453)
-  Driver's and front passenger's seat belt reminder light (→P.453)



Rear passengers' seat belt reminder light<sup>\*2</sup> (→P.453)



Tire pressure warning light<sup>\*1</sup> (→P.454)



LTA indicator<sup>\*2</sup> (→P.454)



Stop & Start cancel indicator<sup>\*3, 4, 5</sup> (if equipped) (flashes) (→P.454)



Intuitive parking assist OFF indicator<sup>\*1, 4, 6</sup> (if equipped) (flashes) (→P.455)



RCTA OFF indicator<sup>\*2, 4</sup> (if equipped) (flashes) (→P.455)



PKSB OFF indicator<sup>\*1, 4, 6</sup> (if equipped) (flashes) (→P.455)



PCS warning light<sup>\*1</sup> (flashes or illuminates) (→P.456)



Slip indicator<sup>\*1</sup> (→P.456)



Parking brake indicator<sup>\*1</sup> (flashes) (→P.457) (U.S.A.)



Parking brake indicator<sup>\*1</sup> (flashes) (→P.457) (Canada)



Brake hold operated indicator<sup>\*1</sup> (flashes) (→P.457)

<sup>\*1</sup>: These lights turn on when the engine switch is turned to ON to indicate that a system check is being performed. They will turn

off after the engine is started, or after a few seconds. There may be a malfunction in a system if a light does not come on, or turn off. Have the vehicle inspected by your Toyota dealer.

<sup>\*2</sup>: This light illuminates on the multi-information display.

<sup>\*3</sup>: 7-inch display only: This light illuminates on the multi-information display.

<sup>\*4</sup>: This light comes on when the system is turned off.

<sup>\*5</sup>: 4.2-inch display only: These lights turn on when the engine switch is turned to ON to indicate that a system check is being performed. They will turn off after the engine is started, or after a few seconds. There may be a malfunction in a system if a light does not come on, or turn off. Have the vehicle inspected by your Toyota dealer.

<sup>\*6</sup>: 7-inch display only

**WARNING**

















**■ If a safety system warning light does not come on**

















Should a safety system light such as the ABS and SRS warning lights not come on when you start the engine, this could mean that these systems are not available to help protect you in an accident, which could result in death or serious injury. Have the vehicle inspected by your Toyota dealer immediately if this occurs.

**Indicators**





The indicators inform the driver of the operating state of the

vehicle's various systems.

-  Turn signal indicator (→P.208)
-  Headlight indicator (→P.214)  
(U.S.A.)
-  Tail light indicator (→P.214)  
(Canada)
-  Headlight high beam indicator (→P.216)
-  Automatic High Beam indicator\*<sup>1</sup> (→P.217)
-  Front fog light indicator\*<sup>1</sup> (if equipped) (→P.220)
-  PCS warning light\*<sup>3, 4</sup> (→P.235)
-  Cruise control indicator\*<sup>2</sup> (→P.261)
-  Dynamic radar cruise control indicator\*<sup>2</sup> (→P.254)
-  Cruise control "SET" indicator\*<sup>2</sup> (→P.254)
-  LTA indicator\*<sup>2</sup> (→P.246)  
(white)
-  LTA indicator\*<sup>2</sup> (→P.246)  
(green)
-  LTA indicator\*<sup>2</sup> (→P.246)  
(orange)  
(flashes)
-  BSM outside rear view mirror indicators\*<sup>5, 6</sup> (if equipped) (→P.271, 284)
-  BSM OFF indicator\*<sup>2, 3</sup> (if equipped) (→P.271)
-  Intuitive parking assist OFF indicator\*<sup>3, 4, 10</sup> (if equipped) (→P.277)

-  RCTA OFF indicator\*<sup>2, 3</sup> (if equipped) (→P.284)
-  PKSB OFF indicator\*<sup>3, 4, 10</sup> (if equipped) (→P.290)
-  Stop & Start indicator\*<sup>1, 9</sup> (if equipped) (→P.264)
-  Stop & Start cancel indicator\*<sup>1, 3, 9</sup> (if equipped) (→P.265)
-  Slip indicator\*<sup>4</sup> (→P.314)  
(flashes)
-  VSC OFF indicator\*<sup>3, 4</sup> (→P.315)
-  Smart key system indicator\*<sup>2</sup> (→P.200)
-  Parking brake indicator\*<sup>4</sup> (→P.209)  
(U.S.A.)
-  Parking brake indicator\*<sup>4</sup> (→P.209)  
(Canada)
-  Brake hold standby indicator\*<sup>4</sup> (→P.212)
-  Brake hold operated indicator\*<sup>4</sup> (→P.212)
-  Snow mode indicator\*<sup>2</sup> (→P.310)
-  Downhill assist control system indicator\*<sup>1, 9</sup> (if equipped) (→P.311)
-  Eco Driving Indicator Light\*<sup>4</sup> (→P.84, 93)
-  Low outside temperature indicator\*<sup>2, 7</sup> (→P.79)
-  Security indicator\*<sup>8</sup> (→P.69, 71)
-  "PASS AIR BAG ON/OFF" indicator\*<sup>4, 8</sup> (→P.41)

● Drive mode indicators

-  Eco drive mode indicator \*2  
(→P.306)
-  Sport mode indicator \*2  
(→P.306)
-  Mud & sand mode indicator \*2 (if equipped)  
(→P.308)
-  Rock & dirt mode indicator \*2 (if equipped)  
(→P.308)



\*1: 7-inch display only: This light illuminates on the multi-information display.

\*2: This light illuminates on the multi-information display.

\*3: This light comes on when the system is turned off.

\*4: These lights turn on when the engine switch is turned to ON to indicate that a system check is being performed. They will turn off after the engine is started, or after a few seconds. There may be a malfunction in a system if a light does not come on, or turn off. Have the vehicle inspected by your Toyota dealer.

\*5: In order to confirm operation, the BSM outside rear view mirror indicators illuminate in the following situations:

- When the BSM function is enabled on  of the multi-information display, the engine switch is turned to ON.
- When the engine switch is in ON, the BSM function is enabled on  of the multi-information display.

If the system is functioning correctly, the BSM outside rear view mirror indicators will turn off after a few seconds. If the BSM outside rear view mirror indicators do not illuminate or do not turn off, there may be a malfunction in the system. If this occurs, have the vehicle inspected by your Toyota dealer.

\*6: This light illuminates on the outside rear view mirrors.

\*7: When the outside temperature is approximately 37°F (3°C) or lower, this indicator will flash for approximately 10 seconds, then stay on.

\*8: This light illuminates on the center panel.

\*9: 4.2-inch display only: These lights turn on when the engine switch is turned to ON to indicate that a system check is being performed. They will turn off after the engine is started, or after a few seconds. There may be a malfunction in a system if a light does not come on, or turn off. Have the vehicle inspected by your Toyota dealer.

\*10: 7-inch display only

## Gauges and meters

### Meter display

#### ■ Locations of gauges and meters

##### ► 4.2-inch display

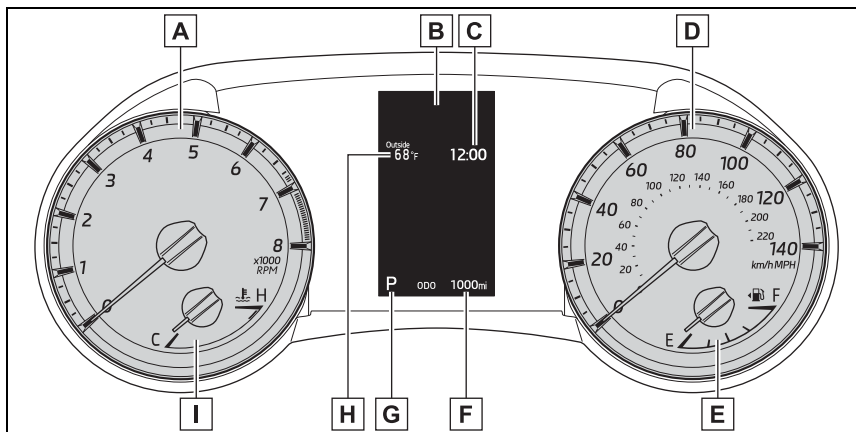

##### ► 7-inch display

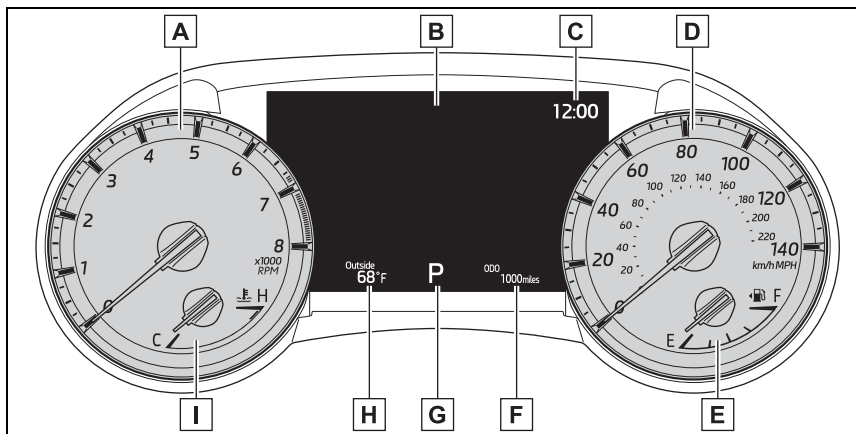

The units used on the meters may differ depending on the target region.

#### **A** Tachometer

Displays the engine speed in revolutions per minute

#### **B** Multi-information display

Presents the driver with a variety of vehicle data (→P.82, 91)

Displays warning messages in case of a malfunction (→P.460)

**C** Clock (→P.82)

**D** Speedometer

**E** Fuel gauge

Displays the quantity of fuel remaining in the tank

**F** Odometer and trip meter display (→P.81)

**G** Shift position display (→P.204)

**H** Outside temperature

Displays the outside temperature within the range of -40°F (-40°C) to 122°F (50°C). Low outside temperature indicator comes on when the ambient temperature is 37°F (3°C) or lower.

**I** Engine coolant temperature gauge

Displays the engine coolant temperature

**■ The meters and display illuminate when**

The engine switch is in ON.

**■ Outside temperature display**

- In the following situations, the correct outside temperature may not be displayed, or the display may take longer than normal to change:
  - When stopped, or driving at low speeds (less than 12 mph [20 km/h])
  - When the outside temperature has changed suddenly (at the entrance/exit of a garage, tunnel, etc.)
- When "--" or "E" is displayed, the system may be malfunctioning. Take your vehicle to your Toyota dealer.

**■ Liquid crystal display**

Small spots or light spots may appear on the display. This phenomenon is characteristic of liquid crystal displays, and there is no problem continuing to use the display.

**■ Customization**

The meters can be customized on

 of the multi-information display. (→P.89, 99)

 **WARNING**

**■ The information display at low temperatures**

Allow the interior of the vehicle to warm up before using the liquid crystal information display. At extremely low temperatures, the information display monitor may respond slowly, and display changes may be delayed.

For example, there is a lag between the driver's shifting and the new gear number appearing on the display. This lag could cause the driver to downshift again, causing rapid and excessive engine braking and possibly an accident resulting in death or injury.

 **NOTICE**

**■ To prevent damage to the engine and its components**

- Do not let the indicator needle of the tachometer enter the red zone, which indicates the maximum engine speed.



 NOTICE

- The engine may be overheating if the engine coolant temperature gauge is in the red zone (H). In this case, immediately stop the vehicle in a safe place, and check the engine after it has cooled completely. (→P.487)

### Odometer and trip meter display

#### ■ Display items

##### ● Odometer

Displays the total distance the vehicle has been driven.

##### ● Trip meter A/trip meter B

Displays the distance the vehicle has been driven since the meter was last reset. Trip meters A and B can be used to record and display different distances independently.

##### ● Distance until next engine oil change

Displays the distance the vehicle can be driven until an oil change is necessary.

#### ■ Changing the display

Each time the “ODO TRIP” switch is pressed, the displayed item will be changed. When the trip meter is displayed, pressing and holding the switch will reset the trip meter.

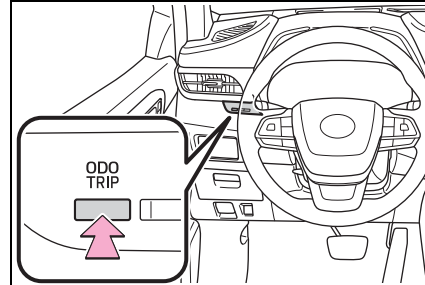

#### ■ Pop-up display

In some situations the following will be temporarily displayed:

Distance until next engine oil change

Displays the distance until the next engine oil change. This display will be displayed in the following situations:

- When the engine switch is turned to ON.
- When a warning message indicating that oil maintenance should be performed soon or is required is displayed.

### Changing the instrument panel light brightness

The brightness of the instrument panel lights can be adjusted.

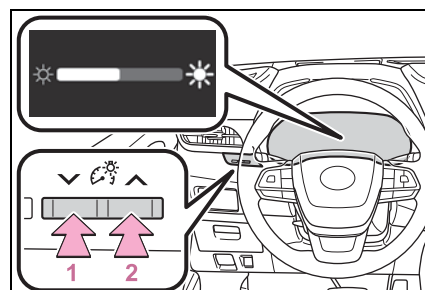

This image is for example only, and may differ from the actual vehicle.

- 1 Darker
- 2 Brighter

**Brightness of the meters (day mode and night mode)**

The brightness of the meters is changed between day mode and night mode.

- Day mode: When the surrounding area is bright
- Night mode: When the surrounding area is dark

**Adjusting the clock**

The clocks can be adjusted on the audio system screen.

Refer to “NAVIGATION AND MULTIMEDIA SYSTEM OWNER’S MANUAL”.

**Multi-information display (4.2-inch display)**

**Display and menu icons**

**Display**





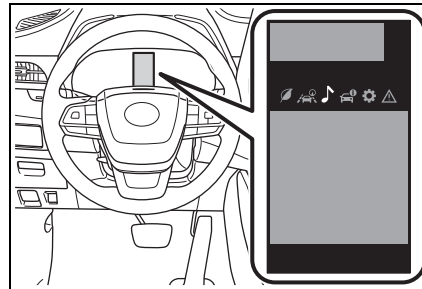

The multi-information display presents the driver with a variety of driving-related information.

Warning or suggestion/advice pop-up displays are also displayed in certain situations.



**Menu icons**

Select a menu icon to display its content.

-  Driving information display (→P.83)
-  Driving support system information display (→P.85)
-  Audio system-linked display (→P.86)
-  Vehicle information display (→P.86)
-  Settings display (→P.87)
-  Warning message display (→P.90)

■ **Liquid crystal display**

Small spots or light spots may appear on the display. This phenomenon is characteristic of liquid crystal displays, and there is no problem continuing to use the display.

**⚠ WARNING**

■ **Caution for use while driving**

- When operating the multi-information display while driving, pay extra attention to the safety of the area around the vehicle.
- Do not look continuously at the multi-information display while driving as you may fail to see pedestrians, objects on the road, etc. ahead of the vehicle.

■ **The information display at low temperatures**

→P.80

**Changing the meter display**

The multi-information display is operated using the meter control switches.

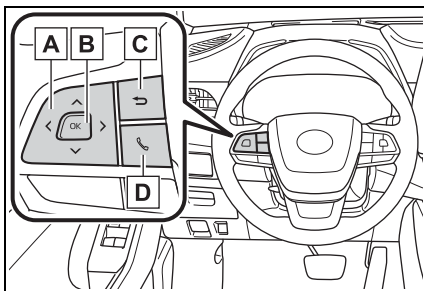

- A** Scroll screens\*, change the displayed content\* and move the cursor
- B** Press: Enter/Set

Press and hold: Reset/Display customizable items

- C** Return to the previous screen
- D** Call sending/receiving and history display

Linked with the hands-free system, sending or receiving call is displayed. For details regarding the hands-free system, refer to the "NAVIGATION AND MULTIMEDIA SYSTEM OWNER'S MANUAL".

\*: On screens where the screen can be scrolled and the display can be switched, a scroll bar or a round icon that shows the number of registered screens is displayed.

**Driving information display (📄)**

■ **Speedometer display/Driving range**

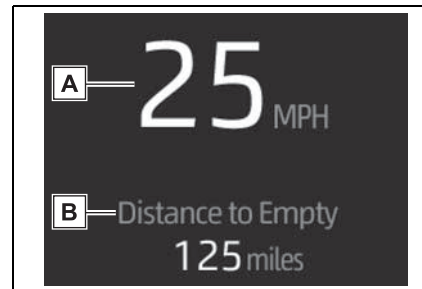

- A** Speedometer display  
Displays the vehicle speed.
- B** Driving range  
Displays driving range with remaining fuel. Use the displayed values as a reference only.  
This distance is computed based on your average fuel consumption.

As a result, the actual distance that can be driven may differ from that displayed.

When only a small amount of fuel is added to the tank, the display may not be updated.

When refueling, turn the engine switch off. If the vehicle is refueled without turning the engine switch off, the display may not be updated.

When "Refuel" is displayed, the remaining fuel amount is low and the distance that can be driven with the remaining fuel cannot be calculated.

Refuel immediately.

■ **Fuel economy**

Use the displayed values as a reference only.

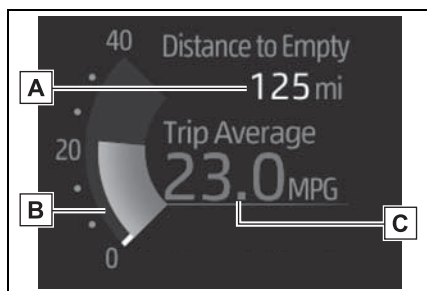

**A** Driving range

Displays driving range with remaining fuel.

This distance is computed based on your average fuel consumption. As a result, the actual distance that can be driven may differ from that displayed.

When only a small amount of fuel is added to the tank, the display may not be updated.

When refueling, turn the engine switch off. If the vehicle is refueled without turning the engine switch

off, the display may not be updated.

When "Refuel" is displayed, the remaining fuel amount is low and the distance that can be driven with the remaining fuel cannot be calculated.

Refuel immediately.

**B** Current fuel economy

Displays the instantaneous current fuel Economy.

**C** Average fuel economy

Displays the average fuel economy since the function was reset or the average fuel economy after starting or refueling.\*1, 2, 3

The average fuel economy display can be changed in . (→P.87)

\*1: Use the displayed fuel consumption as a reference only.

\*2: Average fuel economy since the function was reset can be reset by pressing and holding .

\*3: Average fuel economy after starting is reset each time the engine stops.

■ **Eco Driving Indicator/Driving range**

- Eco Driving Indicator

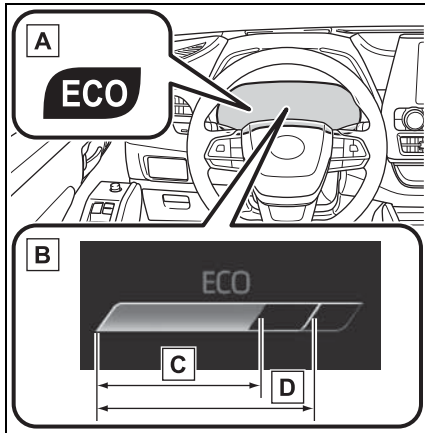

**A** Eco Driving Indicator Light  
During Eco-friendly acceleration (Eco driving), the Eco Driving Indicator Light will turn on. When the acceleration exceeds the Zone of Eco driving, or when the vehicle is stopped, the light turns off.

**B** Eco Driving Indicator Zone Display  
Suggests the Zone of Eco driving with current Eco driving ratio based on acceleration.

**C** Eco driving ratio based on acceleration

If the acceleration exceeds the Zone of Eco driving, the right side of the Eco Driving Indicator Zone Display will illuminate.

At this time, the Eco Driving Indicator Light will turn off.

**D** Zone of Eco driving

- Driving range

Displays driving range with remaining fuel. Use the displayed values as a reference only.

This distance is computed based on your average fuel consumption. As a result, the actual distance that can be driven may differ from that displayed.

When only a small amount of fuel is added to the tank, the display may not be updated.

When refueling, turn the engine switch off. If the vehicle is refueled without turning the engine switch off, the display may not be updated.

When "Refuel" is displayed, the remaining fuel amount is low and the distance that can be driven with the remaining fuel cannot be calculated.

Refuel immediately.

#### ■ Eco Driving Indicator

Eco Driving Indicator will not operate under the following conditions:

- The shift lever is in any position other than D.
- The driving mode is set to sport mode.
- The vehicle speed is approximately 80 mph (130 km/h) or higher.

### Driving support system information display

#### ■ Driving support system information

Select to display the operational status of the following systems:

- LTA (Lane Tracing Assist) (→P.241)
- RSA (Road Sign Assist) (if equipped) (→P.251)

- Dynamic radar cruise control with full-speed range (→P.254)

■ **Navigation system-linked display (if equipped)**

Select to display the following navigation system-linked information:

- Route guidance to destination
- Compass display (head-up display)

■ **Route guidance to destination display**

When the route guidance to destination display is enabled on the head-up display, it will not be displayed on the multi-information display. (→P.103)

**Audio system-linked display** 

Select to enable selection of an audio source or track on the meter using the meter control switches.

This menu icon can be set to be displayed/not displayed in .

**Vehicle information display** 

■ **Drive information**

2 items that are selected using the “Drive Info Items” setting (average speed, distance and total time) can be displayed vertically.

The displayed information changes according to the “Drive Info Type” setting (since the system was started or between resets). (→P.87)

Use the displayed information as a reference only.

Following items will be displayed.

- “Trip”
- “Average Speed”: Displays the average vehicle speed since engine start\*
- “Distance”: Displays the distance driven since engine start\*
- “Total Time”: Displays the elapsed time since engine start\*

\*: These items are reset each time the engine stops.

- “Total”
- “Average Speed”: Displays the average vehicle speed since the display was reset\*
- “Distance”: Displays the distance driven since the display was reset\*
- “Total Time”: Displays the elapsed time since the display was reset\*

\*: To reset, display the desired item and press and hold .

■ **Tire pressure**

→P.414

### ■ AWD Control (if equipped)

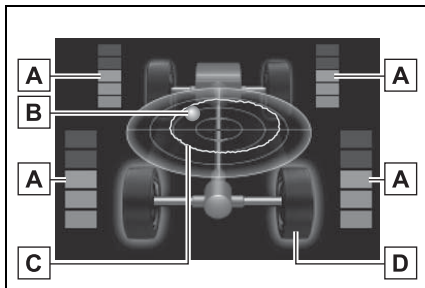

#### **A** Torque distribution display

Displays the drive status of each wheel in 6 steps from 0 to 5.

#### **B** G-force display\*

Displays the size and direction of the G-force applied to the vehicle via changes to the position of the ball on the display.

#### **C** Maximum G-force course\*

This item is linked with the G-force display and the course of the past movement of the ball is displayed.

Press and hold  to reset the record.

#### **D** Wheel spin display

When a tire is spinning, its icon on the display changes its color and blinks.

\*: This item is displayed only when driving mode is set to sport mode.

### ■ Tire pressure

- It may take a few minutes to display the tire inflation pressure after the engine switch is turned to ON. It may also take a few minutes to display the tire inflation pressure after inflation pressure has been adjusted.
- “---” may be displayed if the tire position information cannot be determined due to unfavorable





radio wave conditions.

- Tire inflation pressure changes with temperature. The displayed values may also be different from the values measured using a tire pressure gauge.

### Settings display

#### ■ Changing settings

Use the meter control switches on the steering wheel to change settings.

- 1 Press  or  of the meter control switch to select .
- 2 Press  or  of the meter control switch to select the desired item to be customized.

- 3 Press or press and hold .

The available settings will differ depending on if  is pressed or pressed and held. Follow the instructions on the display.

#### ■ Setting items

-  LTA (Lane Tracing Assist) (→P.241)

Press and hold  to change the settings of the following items:

- “Lane Center”

Select to enable/disable the lane centering function.

- “Steering Assist”

Select to enable/disable steering wheel assistance.

- “Sensitivity”

Select to set the warning sensitivity.

- “Sway Warning”

Select to enable/disable the vehicle sway warning.

- “Sway Sensitivity”

Select to set the vehicle sway warning sensitivity.

-  PCS (Pre-Collision System) (→P.233)

Press  to enable/disable the pre-collision system.

- PCS (Pre-Collision System) on/off

Select to enable/disable the pre-collision system.

Press and hold  to change the settings of the following item:

- “Sensitivity”

Select to change the pre-collision warning timing.

-  BSM (Blind Spot Monitor) (if equipped) (→P.270)

Press  to enable/disable the Blind Spot Monitor function.

- BSM (Blind Spot Monitor) on/off

Select to enable/disable the Blind Spot Monitor function.

Press and hold  to change the settings of the following items:

- “Brightness”

Select to switch the brightness of the outside rear view mirror indicators. (→P.271)

- “Sensitivity”

Select to change the alert timing for an approaching vehicle.

-  RCTA (Rear Cross Traffic Alert) (if equipped) (→P.284)

Press  to enable/disable the Rear Cross Traffic Alert function.

- RCTA (Rear Cross Traffic Alert) on/off

Select to enable/disable the Rear Cross Traffic Alert function.

Press and hold  to change the settings of the following item:

- “Volume”

Select to change the volume of the RCTA buzzer.

-  RSA (Road Sign Assist) (if equipped) (→P.251)

Press  to enable/disable the Road Sign Assist.

- RSA (Road Sign Assist) on/off

Select to enable/disable the Road Sign Assist.

Press and hold  to change the settings of the following items:

- “Notification Method”

Select to change each notification method used to notify the driver when the system recognizes excess speed and no-entry sign.

- “Notification Level”

Select to change each notification level used to notify the driver when the system recognizes a speed limit sign.

### ■ Vehicle settings

Press and hold  to change the settings of the following



items:

-  PBD (Power Back Door) (if equipped)\* (→P.119)
  - “System Settings”
 

Select to enable/disable the power back door system.
  - “Opening Adjustment”
 

Select the open position when power back door is fully open.
  - “Volume”
 

Select to set the volume of the buzzer which sounds when the power back door system operates.
- \*: Vehicles with a power back door
-  (Stop & Start) (if equipped) (→P.264)
 

Select to set the length of time the Stop & Start system will operate when the “A/C” switch of the air conditioning system is on.
- “TPWS” (Tire Pressure Warning System) (→P.414)
  - “Set Pressure” (tire pressure warning system initialization)
 

Select to initialize the tire pressure warning system.
  - “Change Wheel” (change the tire pressure warning system sensor ID code set)
 

Select to change the tire pressure warning system sensor ID code set. To enable this function, a second set of tire pressure warning system sensor ID codes must be registered by a Toyota dealer. For information regarding changing the registered ID code set, contact your Toyota dealer. (→P.420)

- “Change Wheel” (register tire pressure warning system sensor ID codes)

Select to register the ID codes of the tire pressure sensors to the tire pressure warning system.

- “Rear Seat Reminder” (→P.117)

Select to enable/disable the rear seat reminder.

- “Scheduled Maintenance” (→P.395)

Select to reset the scheduled maintenance information (maintenance required message and distance until maintenance necessary) after all maintenance is performed.

- “Oil Maintenance” (→P.404)

Select to reset the oil maintenance information (maintenance required message and distance until maintenance necessary) after an oil change is performed.

#### Meter settings

Press and hold  to change the settings of the following items:

- Language
 

Select to change the language displayed.
- Units
 

Select to change the units of measure displayed.
-  Eco Driving Indicator Light (→P.84)
 

Select to enable/disable the Eco Driving Indicator Light.



**Fuel economy display**

Select to change the average fuel consumption display between after start/after reset. (→P.84)



Select to display/not display the audio system linked display.



Select to change the displayed content of the following:

- Display contents

Select to display/not display the AWD control (if equipped). (→P.87)

- Drive information type

Select to change the drive information type display between after start/after reset.

- Drive information items

Select to set the first and second items of the drive information display to any of the following: average vehicle speed/distance/elapsed time.

- Pop-up display

Select to enable/disable pop-up displays for each relevant system.

- Multi-information display off

Displays a blank screen.

- Default setting

Select to reset the meter display settings to the default setting.

**Vehicle functions and settings that can be changed**

→P.515

**Suspension of the settings display**

- Some settings cannot be changed while driving. When changing settings, park the vehicle in a safe place.
- If a warning message is displayed, operation of the settings display will be suspended.

**Pop-up displays**

Depending on the pop-up display, the currently displayed item in the message display area may be temporarily not displayed. The item will be displayed after the pop-up display is no longer displayed.

**WARNING**

**Cautions during setting up the display**

As the engine needs to be running during setting up the display, ensure that the vehicle is parked in a place with adequate ventilation. In a closed area such as a garage, exhaust gases including harmful carbon monoxide (CO) may collect and enter the vehicle. This may lead to death or a serious health hazard.

**NOTICE**

**During setting up the display**

To prevent battery discharge, ensure that the engine is running while setting up the display features.

**Warning message display**



Select to display warning messages and measures to be taken if a malfunction is detected. (→P.460)

### Suggestion function

Displays suggestions to the driver in the following situations. To select a response to a displayed suggestion, use the meter control switches.

#### ■ Suggestion to turn off the headlights

If the headlights are left on for a certain amount of time after the engine switch has been turned off, if the headlight switch is in the "AUTO" position, a suggestion message will be displayed asking if you wish to turn the headlights off.

To turn the headlights off, select "Yes".

If the driver's door is opened after the engine switch is turned off, this suggestion message will not be displayed.

#### ■ Customization

Some functions can be customized. (→P.515)

### Multi-information display (7-inch display)

#### Display and menu icons

##### ■ Display





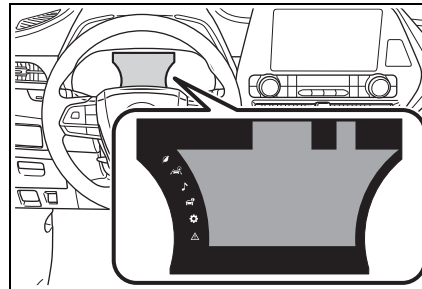

The multi-information display presents the driver with a variety of driving-related information.

Warning or suggestion/advice pop-up displays are also displayed in certain situations.



##### ■ Menu icons

Select a menu icon to display its content.

-  Driving information display (→P.92)
-  Driving support system information display (→P.95)
-  Audio system-linked display (→P.95)
-  Vehicle information display (→P.95)
-  Settings display (→P.96)
-  Warning message display (→P.100)

### ■ Liquid crystal display

Small spots or light spots may appear on the display. This phenomenon is characteristic of liquid crystal displays, and there is no problem continuing to use the display.

### ⚠ WARNING

#### ■ Caution for use while driving

- When operating the multi-information display while driving, pay extra attention to the safety of the area around the vehicle.
- Do not look continuously at the multi-information display while driving as you may fail to see pedestrians, objects on the road, etc. ahead of the vehicle.

#### ■ The information display at low temperatures

→P.80

### Changing the meter display

The multi-information display is operated using the meter control switches.

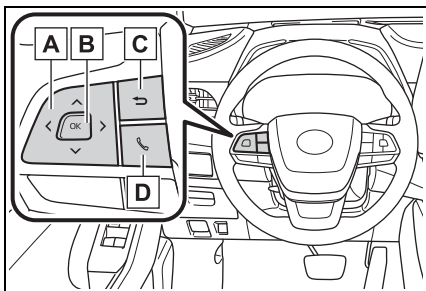

- A** Scroll screens\*, change the displayed content\* and move the cursor
- B** Press: Enter/Set

Press and hold: Reset/Display customizable items

- C** Return to the previous screen
- D** Call sending/receiving and history display

Linked with the hands-free system, sending or receiving call is displayed. For details regarding the hands-free system, refer to the "NAVIGATION AND MULTIMEDIA SYSTEM OWNER'S MANUAL".

\*: On screens where the screen can be scrolled and the display can be switched, a scroll bar or a round icon that shows the number of registered screens is displayed.

### Driving information display (📄)

#### ■ Fuel economy

Use the displayed values as a reference only.

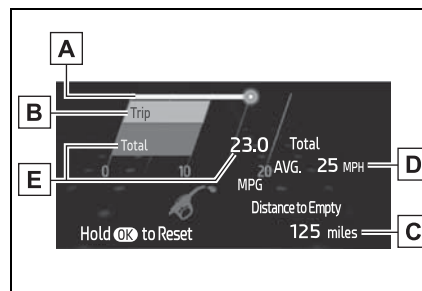

- A** Current fuel consumption  
Displays the instantaneous current fuel consumption.
- B** Average fuel economy (after start)  
Displays the average fuel consumption since engine start.\*1

**C** Driving range

Displays the driving range with remaining fuel.

This distance is computed based on your average fuel consumption. As a result, the actual distance that can be driven may differ from that displayed.

When only a small amount of fuel is added to the tank, the display may not be updated.

When refueling, turn the engine switch off. If the vehicle is refueled without turning the engine switch off, the display may not be updated.

When "Refuel" is displayed, the remaining fuel amount is low and the distance that can be driven with the remaining fuel cannot be calculated.

Refuel immediately.

**D** Gadget<sup>\*2</sup>

The following items can be displayed by changing the settings for gadget content and fuel economy type on . (→P.96)

- Other

Blank: No item

- Average vehicle speed

After start: Displays average vehicle speed since engine start

After reset: Displays average vehicle speed since the display was reset<sup>\*3</sup>

- Distance

After start: Displays the distance driven since vehicle start.

After reset: Displays the distance driven since the display was reset<sup>\*3</sup>

- Elapsed time

After start: Displays elapsed time

since engine start

After reset: Displays elapsed time since the display was reset<sup>\*3</sup>

**E** Average fuel economy

Displayed item (listed below) can be changed on the fuel economy type screen of . (→P.96)

- Total (after reset)

Displays the average fuel consumption since the display was reset.<sup>\*1, 3</sup>

- Tank (after refuel)

Displays the average fuel consumption since the vehicle was refueled.<sup>\*1</sup>

When only a small amount of fuel is added to the tank, the display may not be updated.

When refueling, turn the engine switch off. If the vehicle is refueled without turning the engine switch off, the display may not be updated.

<sup>\*1</sup>: Use the displayed fuel consumption as a reference only.

<sup>\*2</sup>: The default setting is no display.

<sup>\*3</sup>: This display can be reset by

pressing and holding  while it is displayed.

**Eco Driving Indicator/Driving range**

- Eco Driving Indicator

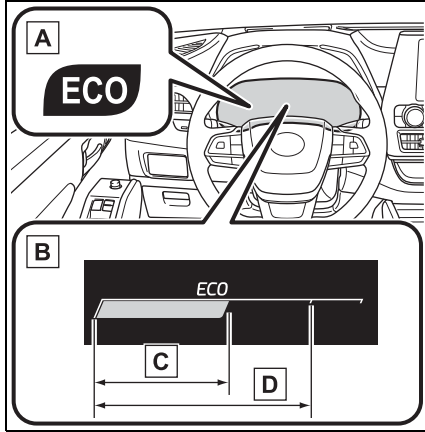

**A Eco Driving Indicator Light**  
 During Eco-friendly acceleration (Eco driving), the Eco Driving Indicator Light will turn on. When the acceleration exceeds the Zone of Eco driving, or when the vehicle is stopped, the light turns off.

**B Eco Driving Indicator Zone Display**  
 Suggests the Zone of Eco driving with current Eco driving ratio based on acceleration.

**C Eco driving ratio based on acceleration**  
 If the acceleration exceeds the Zone of Eco driving, the right side of the Eco Driving Indicator Zone Display will illuminate.

**D Zone of Eco driving**

- Driving range

Displays driving range with remaining fuel. Use the displayed values as a reference only.

This distance is computed based on your average fuel consumption. As a result, the actual distance that can be driven may differ from that displayed.

When only a small amount of fuel is added to the tank, the display may not be updated.

When refueling, turn the engine switch off. If the vehicle is refueled without turning the engine switch off, the display may not be updated.

When "Refuel" is displayed, the remaining fuel amount is low and the distance that can be driven with the remaining fuel cannot be calculated.

Refuel immediately.

■ **Speedometer display (digital speed)/Driving range**

- Speedometer display (digital speed)

→P.99

- Driving range

Displays driving range with remaining fuel. Use the displayed values as a reference only.

This distance is computed based on your average fuel consumption. As a result, the actual distance that can be driven may differ from that displayed.

When only a small amount of fuel is added to the tank, the display may not be updated.

When refueling, turn the engine switch off. If the vehicle is refueled without turning the engine switch off, the display may not be updated.

When "Refuel" is displayed, the remaining fuel amount is low and the distance that can be driven with the remaining fuel cannot be calculated.

Refuel immediately.

#### ■ Eco Driving Indicator

Eco Driving Indicator will not operate under the following conditions:

- The shift lever is in any position other than D.
- The driving mode is set to sport mode.
- The vehicle speed is approximately 80 mph (130 km/h) or higher.

### Driving support system information display

#### ■ Driving support system information

Select to display the operational status of the following systems:

- LTA (Lane Tracing Assist) (→P.241)
- RSA (Road Sign Assist) (if equipped) (→P.251)
- Dynamic radar cruise control with full-speed range (→P.254)

#### ■ Navigation system-linked display (if equipped)

Select to display the following navigation system-linked information:

- Route guidance to destination
- Compass display (head-up display)

#### ■ Route guidance to destination display

When the route guidance to destination display is enabled on the head-up display, it will not be displayed on the multi-information display. (→P.103)

### Audio system-linked display

Select to enable selection of an audio source or track on the meter using the meter control switches.

This menu icon can be set to be displayed/not displayed in .

### Vehicle information display

#### ■ Tire pressure

→P.414

#### ■ AWD Control (if equipped)

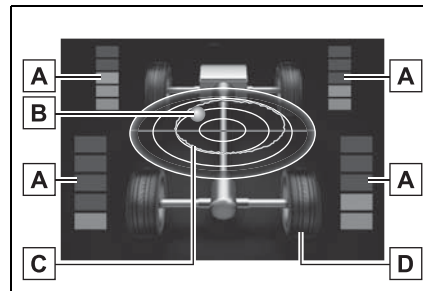

#### **A** Torque distribution display

Displays the drive status of each wheel in 6 steps from 0 to 5.

#### **B** G-force display\*

Displays the size and direction of the G-force applied to the vehicle

via changes to the position of the ball on the display.

**C** Maximum G-force course\*

This item is linked with the G-force display and the course of the past movement of the ball is displayed.

Press and hold  to reset the record.

**D** Wheel spin display

When a tire is spinning, its icon on the display changes its color and blinks.

\*: This item is displayed only when driving mode is set to sport mode.

■ **Safety system status**

Enable/Disable the following systems:

- PCS (Pre-Collision system) (→P.233)
- Intuitive parking assist (if equipped) (→P.276)
- BSM (Blind Spot Monitor) (if equipped) (→P.270)
- RCTA (Rear Crossing Traffic Alert) (if equipped) (→P.284)

■ **Tire pressure**





- It may take a few minutes to display the tire inflation pressure after the engine switch is turned to ON. It may also take a few minutes to display the tire inflation pressure after inflation pressure has been adjusted.
- “---” may be displayed if the tire position information cannot be determined due to unfavorable radio wave conditions.
- Tire inflation pressure changes with temperature. The displayed values may also be different from

the values measured using a tire pressure gauge.

**Settings display **

■ **Changing settings**

Use the meter control switches on the steering wheel to change settings.

- 1 Press  or  of the meter control switch to select .
- 2 Press  or  of the meter control switch to select the desired item to be customized.

- 3 Press or press and hold .

The available settings will differ depending on if  is pressed or pressed and held. Follow the instructions on the display.

■ **Setting items**

-  LTA (Lane Tracing Assist) (→P.241)

Press and hold  to change the settings of the following items:

- “Lane Center”  
Select to enable/disable the lane centering function.
- “Steering Assist”  
Select to enable/disable steering wheel assistance.
- “Sensitivity”  
Select to set the warning sensitivity.
- “Sway Warning”  
Select to enable/disable the vehicle sway warning.



- “Sway Sensitivity”

Select to set the vehicle sway warning sensitivity.

-  PCS (Pre-Collision System) (→P.233)

Press  to enable/disable the pre-collision system.

- PCS (Pre-Collision System) on/off

Select to enable/disable the pre-collision system.

Press and hold  to change the settings of the following item:

- “Sensitivity”

Select to change the pre-collision warning timing.

-  BSM (Blind Spot Monitor) (if equipped) (→P.270)

Press  to enable/disable the Blind Spot Monitor function.

- BSM (Blind Spot Monitor) on/off

Select to enable/disable the Blind Spot Monitor function.

Press and hold  to change the settings of the following items:

- “Brightness”

Select to switch the brightness of the outside rear view mirror indicators. (→P.271)

- “Sensitivity”

Select to change the alert timing for an approaching vehicle.

-  Intuitive parking assist (if equipped) (→P.276)

Press  to enable/disable the

Intuitive parking assist.

- Intuitive parking assist on/off

Select to enable/disable the Intuitive parking assist.

Press and hold  to change the settings of the following item:

- “Volume”

Select to set the volume of the buzzer which sounds when the Intuitive parking assist is operated.

-  RCTA (Rear Cross Traffic Alert) (if equipped) (→P.284)

Press  to enable/disable the Rear Cross Traffic Alert function.

- RCTA (Rear Cross Traffic Alert) on/off

Select to enable/disable the Rear Cross Traffic Alert function.

Press and hold  to change the settings of the following item:

- “Volume”

Select to change the volume of the RCTA buzzer.

-  PKSB (Parking Support Brake) (if equipped) (→P.289)

Press  to enable/disable the Parking Support Brake function.

-  HUD (Head-up display) (if equipped) (→P.101)

Press  to enable/disable the head-up display.

- HUD (Head-up display) on/off

Select to enable/disable the head-up display.

Press and hold  to change the settings of the following items:

- “HUD Brightness/Position”

Select to adjust the brightness/position of the head-up display.

- “HUD Driving Support”

Select to change the displayed head-up display driving support item.

- “HUD Rotation”

Select to adjust the angle of the head-up display.

-  RSA (Road Sign Assist) (if equipped) (→P.251)

Press  to enable/disable the Road Sign Assist.

- RSA (Road Sign Assist) on/off

Select to enable/disable the Road Sign Assist.

Press and hold  to change the settings of the following items:

- “Notification Method”

Select to change each notification method used to notify the driver when the system recognizes excess speed and no-entry sign.

- “Notification Level”

Select to change each notification level used to notify the driver when the system recognizes a speed limit sign.

### Vehicle settings

Press and hold  to change the settings of the following items:

-  PBD (Power Back Door)

(→P.119)

- “System Settings”

Select to enable/disable the power back door system.

- “Kick Sensor”\*

Select to enable/disable the kick sensor.

- “Opening Adjustment”

Select the open position when power back door is fully open.

- “Volume”

Select to set the volume of the buzzer which sounds when the power back door system operates.

\*: Vehicles with a hands free power back door

-  (Stop & Start) (if equipped) (→P.264)

Select to set the length of time the Stop & Start system will operate when the “A/C” switch of the air conditioning system is on.

- “TPWS” (Tire Pressure Warning System) (→P.414)

- “Set Pressure” (tire pressure warning system initialization)

Select to initialize the tire pressure warning system.

- “Change Wheel” (change the tire pressure warning system sensor ID code set)

Select to change the tire pressure warning system sensor ID code set. To enable this function, a second set of tire pressure warning system sensor ID codes must be registered by a Toyota dealer. For information regarding changing the registered ID code set, contact your Toyota

dealer. (→P.420)

- “Change Wheel” (register tire pressure warning system sensor ID codes)

Select to register the ID codes of the tire pressure sensors to the tire pressure warning system.

- “Rear Seat Reminder” (→P.117)

Select to enable/disable the rear seat reminder.

- “Scheduled Maintenance” (→P.395)

Select to reset the scheduled maintenance information (maintenance required message and distance until maintenance necessary) after all maintenance is performed.

- “Oil Maintenance” (→P.404)

Select to reset the oil maintenance information (maintenance required message and distance until maintenance necessary) after an oil change is performed.

#### ■ Meter settings

Press and hold  to change the settings of the following items:

- Language

Select to change the language displayed.

- Units

Select to change the units of measure displayed.

-  Eco Driving Indicator Light (→P.93)

Select to enable/disable the Eco

Driving Indicator Light.

- Speedometer display (digital speed)

Select to enable/disable the speedometer display.

- Gadget content

Select to turn the display of a gadget.

- Fuel economy type

Select to change the average fuel consumption display and an item to be displayed as gadget.

- Pop-up display

Select to enable/disable pop-up displays for each relevant system.

- Multi-information display off

Displays a blank screen.

- Default setting

Select to reset the meter display settings to the default setting.

#### ■ Vehicle functions and settings that can be changed

→P.515

#### ■ Background color of the indicator/shift position display area

The background color of the indicator/shift position display area is changed according to the driving mode as follows (→P.306):

- Eco drive mode: Blue
- Sport mode: Red

#### ■ Suspension of the settings display

- Some settings cannot be changed while driving. When changing settings, park the vehicle in a safe place.
- If a warning message is displayed,

operation of the settings display will be suspended.

■ **Pop-up displays**

Depending on the pop-up display, the currently displayed item in the message display area may be temporarily not displayed. The item will be displayed after the pop-up display is no longer displayed.

 **WARNING**

■ **Cautions during setting up the display**

As the engine needs to be running during setting up the display, ensure that the vehicle is parked in a place with adequate ventilation. In a closed area such as a garage, exhaust gases including harmful carbon monoxide (CO) may collect and enter the vehicle. This may lead to death or a serious health hazard.

 **NOTICE**

■ **During setting up the display**

To prevent battery discharge, ensure that the engine is running while setting up the display features.

**Warning message display**



Select to display warning messages and measures to be taken if a malfunction is detected. (→P.460)

**Suggestion function**

Displays suggestions to the driver in the following situations. To select a response to a dis-

played suggestion, use the meter control switches.

■ **Suggestion to turn off the headlights**

If the headlights are left on for a certain amount of time after the engine switch has been turned off, if the headlight switch is in the “AUTO” position, a suggestion message will be displayed asking if you wish to turn the headlights off.

To turn the headlights off, select “Yes”.

If the driver's door is opened after the engine switch is turned off, this suggestion message will not be displayed.

■ **Customization**

Some functions can be customized. (→P.515)

**Head-up display\***

\*: If equipped

The head-up display is linked to the meters and navigation system (if equipped) and projects a variety of information in front of the driver, such as the current vehicle speed and route guidance to a set destination.

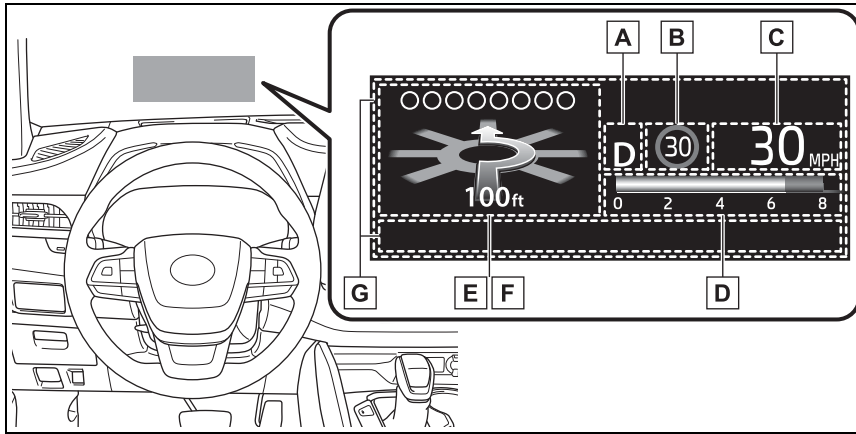
**System components****2**

Illustrations used in this text are intended as examples, and may differ from the image that is actually displayed by the head-up display.

- A** Shift position display (→P.204)
- B** Speed limit/RSA (Road Sign Assist) display area  
Displays the following items:
  - Speed limit of the current road (linked to the navigation system) (U.S.A. only)
  - RSA (Road Sign Assist) display (if equipped) (→P.251)
- C** Vehicle speed display area
- D** Eco Driving Indicator/Tachometer/Outside temperature (→P.104)
- E** Navigation system-linked display area (if equipped) (→P.104)  
Displays the following items, which are linked to the navigation system:
  - Route guidance to destination
  - Street name
  - Compass (heading-up display)
- F** Driving assist system status display area (→P.105)

Vehicle status information and indicators

**G** Message display area (→P.105)

The following pop-up displays will be displayed in certain situations:

- Warning/message
- Hands-free system status
- Audio system operation status

**■ Head-up display will operate when**

The engine switch is in ON.

**■ When using the head-up display**

The head-up display may seem dark or hard to see when viewed through sunglasses, especially polarized sunglasses. Adjust the brightness of the head-up display or remove your sunglasses.

**■ Outside temperature display**

If the outside temperature becomes approximately 37°F (3°C) or lower, the low outside temperature indicator will flash for 10 seconds then the low outside temperature indicator and outside temperature display will turn off. The low outside temperature indicator will operate again if the outside temperature becomes approximately 41°F (5°C) or more and then decreases to 37°F (3°C) or lower.

**⚠ WARNING**

**■ Before using the head-up display**

- Check that the position and brightness of the head-up display image does not interfere with safe driving. Incorrect adjustment of the image's position or brightness may obstruct the driver's view and lead to an accident, resulting in death or serious injury.

- Do not continuously look at the head-up display while driving as you may fail to see pedestrians, objects on the road, etc. ahead of the vehicle.

**⚠ NOTICE**

**■ To prevent damage to components**

- Do not place any drinks near the head-up display projector. If the projector gets wet, electrical malfunctions may result.

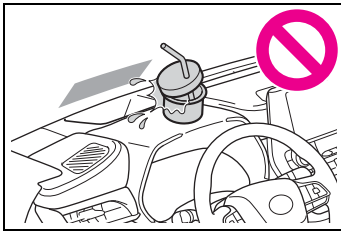

- Do not place anything on or put stickers onto the head-up display projector. Doing so could interrupt head-up display indications.
- Do not touch the inside of the head-up display projector or thrust sharp edges or the like into the projector. Doing so could cause mechanical malfunctions.

**Using the head-up display**

**■ Changing settings of the head-up display**

Select  on the multi-informa-

tion display (→P.515) and then .

■ **Enabling/disabling the head-up display**

Press  to enable/disable the head-up display.

■ **Changing the head-up display settings**

Press and hold  to display the following settings.

● “HUD Brightness/Position”

Select to adjust the brightness and vertical position of the head-up display.

● “HUD Driving Support”

- Tachometer Settings

Blank/Eco Indicator/Tachometer

Select to change the display to blank (no display)/Eco Driving Indicator/tachometer.

Select to enable/disable the following items:

- Navigation (if equipped)
- Driving Assist
- Compass (if equipped)
- Audio

● “HUD Rotation”

Select to adjust the angle of the head-up display.

Press the < or > switch to adjust the angle of the head-up display.

■ **Enabling/disabling of the head-up display**

If the head-up display is disabled, it

will remain disabled when the engine switch is turned off then back to ON.

■ **Display brightness**

The brightness of the head-up display can be adjusted on  of the multi-information display. Also, it is automatically adjusted according to the ambient brightness.

■ **Automatic adjustment of the head-up display position (vehicles with driving position memory)**

A desired head-up display position can be entered to memory and recalled automatically by the driving position memory system. (→P.144)

■ **When the battery is disconnected**

The customize settings of the head-up display will be reset.

■ **Customization**

Some functions can be customized. (→P.515)

 **WARNING**

■ **Caution for changing settings of the head-up display**

As the engine needs to be running while changing the settings of the head-up display, ensure that the vehicle is parked in a place with adequate ventilation. In a closed area such as a garage, exhaust gases including harmful carbon monoxide (CO) may collect and enter the vehicle. This may lead to death or a serious health hazard.

 **NOTICE**

■ **When changing the settings of the head-up display**

To prevent battery discharge, ensure that the engine is running while the changing the settings of the head-up display.

**Eco Driving Indicator/Tachometer/Outside temperature**

■ **Eco Driving Indicator**

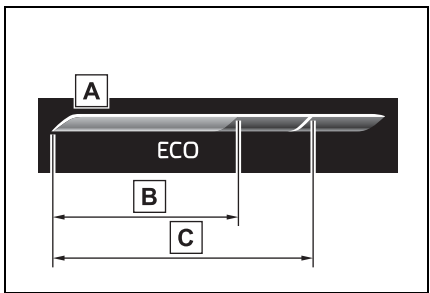

- A** Eco Driving Indicator Zone Display
- B** Eco driving ratio based on acceleration
- C** Zone of Eco driving  
Displayed content is the same as that displayed on the multi-information display (Eco Driving Indicator). For details, refer to P.93.

■ **Tachometer**

Displays the engine speed in revolutions per minute.

■ **Outside temperature**

Displayed in the following situations:

- When the engine switch is turned to ON (Displayed for

approximately 10 seconds)

- When the low outside temperature indicator is flashing

Displayed content is the same as that displayed on the multi-information display. For details, refer to the explanation of the outside temperature display on the multi-information display. (→P.80)

**Navigation system-linked display area (if equipped)**

Displays the following navigation system linked items:

(Refer to “NAVIGATION AND MULTIMEDIA SYSTEM OWNER’S MANUAL”.)

■ **Route guidance to destination**

Displayed when the navigation system is performing route guidance. When approaching an intersection, an arrow indicating the suggested direction of travel will be displayed.

■ **Street name**

Depending on the situation, the names of the streets of an approaching intersection will be displayed.

■ **Compass (heading-up display)**

Displays the direction of travel.



■ **Street name display (vehicles with a navigation system)**

Depending on the situation, such as when no information is available in map data, etc., the street names of an intersection may not be displayed.

**Driving assist system status display area**

Displays the operational status of the following systems:

- LTA (Lane Tracing Assist) (→P.241)
- Dynamic radar cruise control with full-speed range (→P.254)
- PCS (Pre-Collision System) (→P.233)
- Parking Support Brake function (for static objects) (if equipped) (→P.296)
- Intuitive parking assist (if equipped) (→P.276)
- Drive-Start Control (→P.178)
- Brake Override System (→P.178)

Displayed content is the same as that displayed on the multi-information display. For details, refer to the explanations of each system.

  **icons**

Displays the following multi-information display linked icons and a message:

: Master warning icon

Displayed when a warning message is displayed on the multi-information display. (→P.460)

: Information icon

Displayed when a suggestion/advice pop-up display is displayed on the multi-information display. (→P.91, 100)

**Message display area**

Depending on the situation, the following will be displayed:

■ **Warning/Message**

Depending on the situation, a warning message or other message will be displayed.

● **Warning messages**

Certain warning messages can be displayed.

● **Pop-up displays**

When the driving assist system operates, some of the information displayed on the multi-information display will be displayed on the head-up display as a pop-up display.

■ **Hands-free system status**

Displayed when the hands-free system is operated.

(Refer to “NAVIGATION AND MULTIMEDIA SYSTEM OWNER’S MANUAL”.)

■ **Audio system operation status**

Displayed when the audio sys-

tem is operated.

(Refer to “NAVIGATION AND MULTIMEDIA SYSTEM OWNER’S MANUAL”.)

■ **Pop-up displays**

Depending on the pop-up display, the currently displayed item in the message display area may be temporarily not displayed. The item will be displayed after the pop-up display is no longer displayed.

**Fuel consumption information**

**Fuel consumption information can be displayed on the audio system screen.**

**Vehicles with a 12.3-inch display: The fuel consumption information can be displayed and operated on the Toyota multi-operation touch.**

**System components**

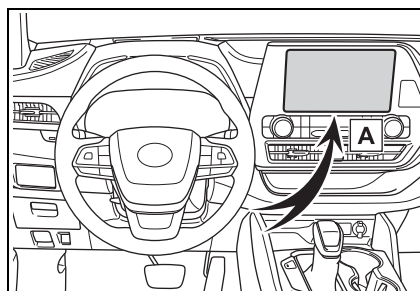

**A** Audio system screen

**Consumption**

■ **Trip information**

▶ Audio or Audio Plus (vehicles without Data Communication Module)

- 1** Press the “MENU” button.
- 2** Select “Info” on the “Menu” screen.

If a screen other than “Trip Information” is displayed, select “Trip Information”.

- ▶ Audio Plus (vehicles with Data Communication Module) or Premium Audio
- 1 Press the “MENU” button.
- 2 Select “Info” on the “Menu” screen.
- 3 Select “ECO” on the “Information” screen.

If a screen other than “Trip Information” is displayed, select “Trip Information”.

- ▶ 12.3-inch display
- 1 Select  Toyota multi-operation touch (→P.326).
- 2 Select “TripInfo.”.

The screen position can also be changed by select a desired information in full screen.

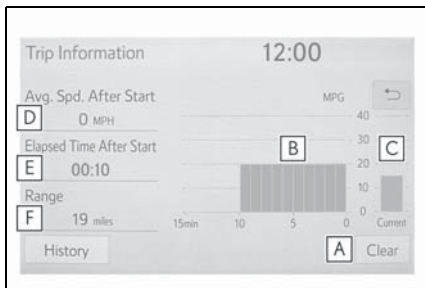

- A** Resetting the consumption data
- B** Fuel consumption in the past 15 minutes
- C** Current fuel consumption
- D** Average vehicle speed since the engine was started.
- E** Elapsed time since the engine was started.
- F** Cruising range

The average fuel consumption history is divided by color into past averages and the average fuel consumption since the last updated. Use the displayed average fuel consumption as a reference.

The image is an example only, and may vary slightly from actual conditions.

■ **History**

- ▶ Audio or Audio Plus (vehicles without Data Communication Module)
- 1 Press the “MENU” button.
- 2 Select “Info” on the “Menu” screen.

If a screen other than “History” is displayed, select “History”.

- ▶ Audio Plus (vehicles with Data Communication Module) or Premium Audio
- 1 Press the “MENU” button.
- 2 Select “Info” on the “Menu” screen.
- 3 Select “ECO” on the “Information” screen.

If a screen other than “History” is displayed, select “History”.

- ▶ 12.3-inch display
- 1 Select  Toyota multi-operation touch (→P.326).
- 2 Select “History”.

The screen position can also be changed by select a desired information in full screen.



- A** Best recorded fuel consumption
- B** Latest fuel consumption
- C** Previous fuel consumption record
- D** Resetting the history data
- E** Updating the latest fuel consumption data

The average fuel consumption history is divided by color into past averages and the average fuel consumption since the last updated. Use the displayed average fuel consumption as a reference.

The image is an example only, and may vary slightly from actual conditions.

**■ Updating the history data**

Update the latest fuel consumption by selecting “Update” to measure the current fuel consumption again.

**■ Resetting the data**

The fuel consumption data can be deleted by selecting “Clear”.

**■ Cruising range**

Displays the estimated maximum distance that can be driven with the quantity of fuel remaining.

This distance is computed based on

your average fuel consumption. As a result, the actual distance that can be driven may differ from that displayed.

**Using the Toyota multi-operation touch (vehicles with a 12.3-inch display)**

Display the vehicle information on the Toyota multi-operation touch (→P.326), and then select the button to display the desired screen.

The image is an example only, and may vary slightly from actual conditions.

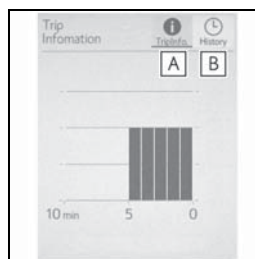

- A** Trip information
- B** History

**■ Trip information**

Displays the average fuel consumption for the past 10 minutes in 1 minute intervals, as well as the cruising range.

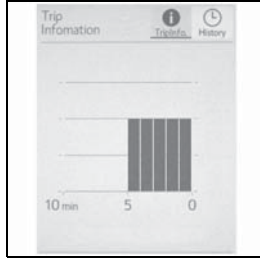

Use the displayed average fuel consumption as a reference.

■ **History**

Displays the average fuel consumption and highest fuel consumption.



Use the displayed average fuel consumption as a reference.

2

Vehicle status information and indicators



- 3-1. Key information**  
 Keys ..... 112
- 3-2. Opening, closing and locking the doors**  
 Side doors ..... 115  
 Back door ..... 119  
 Smart key system ..... 131
- 3-3. Adjusting the seats**  
 Front seats ..... 138  
 Rear seats ..... 139  
 Driving position memory  
 ..... 144  
 Head restraints ..... 147
- 3-4. Adjusting the steering wheel and mirrors**  
 Steering wheel ..... 150  
 Inside rear view mirror  
 ..... 151  
 Digital Rearview Mirror  
 ..... 152  
 Outside rear view mirrors  
 ..... 162
- 3-5. Opening, closing the windows and moon roof**  
 Power windows ..... 164  
 Moon roof ..... 167  
 Panoramic moon roof.. 170

## Keys

### The keys

The following keys are provided with the vehicle.

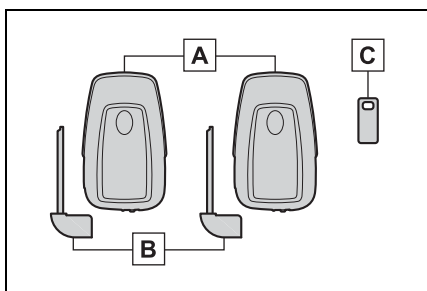

#### A Electronic keys

- Operating the smart key system (→P.131)
- Operating the wireless remote control function (→P.113)

#### B Mechanical keys

#### C Key number plate

### ■ When riding in an aircraft

When bringing an electronic key onto an aircraft, make sure you do not press any buttons on the electronic key while inside the aircraft cabin. If you are carrying an electronic key in your bag, etc., ensure that the buttons are not likely to be pressed accidentally. Pressing a button may cause the electronic key to emit radio waves that could interfere with the operation of the aircraft.

### ■ Electronic key battery depletion

- The standard battery life is 1 to 2 years.
- If the battery becomes low, an alarm will sound in the cabin when the engine is stopped.
- To reduce key battery depletion

when the electronic key is to not be used for long periods of time, set the electronic key to the battery-saving mode. (→P.132)

- As the electronic key always receives radio waves, the battery will become depleted even if the electronic key is not used. The following symptoms indicate that the electronic key battery may be depleted. Replace the battery when necessary.
- The smart key system or the wireless remote control does not operate.
- The detection area becomes smaller.
- The LED indicator on the key surface does not turn on.
- To avoid serious deterioration, do not leave the electronic key within 3 ft. (1 m) of the following electrical appliances that produce a magnetic field:
  - TVs
  - Personal computers
  - Cellular phones, cordless phones and battery chargers
  - Recharging cellular phones or cordless phones
  - Table lamps
  - Induction cookers

### ■ Replacing the battery

→P.428

### ■ Confirmation of the registered key number

The number of keys already registered to the vehicle can be confirmed. Ask your Toyota dealer for details.

### ■ If “A New Key has been Registered Contact Your Dealer for Details” is shown on the multi-information display

This message will be displayed each time the driver's door is opened when the doors are unlocked from the outside for approximately 10 days after a new electronic key has been registered.



If this message is displayed but you have not had a new electronic key registered, ask your Toyota dealer to check if an unknown electronic key (other than those in your possession) has been registered.

 **NOTICE**

**■ To prevent key damage**

- Do not drop the keys, subject them to strong shocks or bend them.
- Do not expose the keys to high temperatures for long periods of time.
- Do not get the keys wet or wash them in an ultrasonic washer, etc.
- Do not attach metallic or magnetic materials to the keys or place the keys close to such materials.
- Do not disassemble the keys.
- Do not attach a sticker or anything else to the surface of the electronic key.
- Do not place the keys near objects that produce magnetic fields, such as TVs, audio systems and induction cookers.
- Do not place the keys near medical electrical equipment such as low-frequency therapy equipment or microwave therapy equipment, and do not receive medical attention with the keys on your person.

**■ Carrying the electronic key on your person**

Carry the electronic key 3.9 in. (10 cm) or more away from electric appliances that are turned on. Radio waves emitted from electric appliances within 3.9 in. (10 cm) of the electronic key may interfere with the key, causing the key to not function properly.

**■ In case of a smart key system malfunction or other key-related problems**

→P.481

**■ When an electronic key is lost**

→P.479

**Wireless remote control**

The electronic keys are equipped with the following wireless remote control:

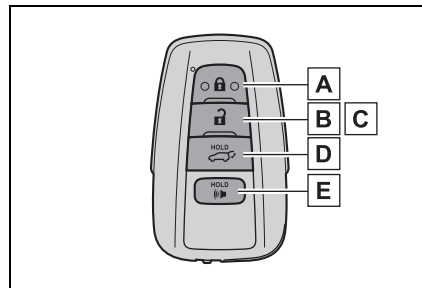

- A** Locks the doors (→P.115)
- B** Unlocks the doors (→P.115)
- C** Opens the windows<sup>\*1</sup> and moon roof<sup>\*1, 2</sup> (→P.115)
- D** Opens and closes the power back door<sup>\*2</sup> (→P.122)
- E** Sounds the alarm

<sup>\*1</sup>: These settings must be customized at your Toyota dealer.

**3**  
Before driving

\*2: If equipped

■ **Theft deterrent panic mode**

When  is pressed for longer than about one second, an alarm will sound intermittently and the vehicle lights will flash to deter any person from trying to break into or damage your vehicle.

To stop the alarm, press any button on the electronic key.



**Using the mechanical key**

To take out the mechanical key, slide the release button and take the key out.

The mechanical key can only be inserted in one direction, as the key only has grooves on one side. If the key cannot be inserted in a lock cylinder, turn it over and re-attempt to insert it.

After using the mechanical key, store it in the electronic key. Carry the mechanical key together with the electronic key. If the electronic key battery is depleted or the entry function does not operate properly, you will need the mechanical key. (→P.481)

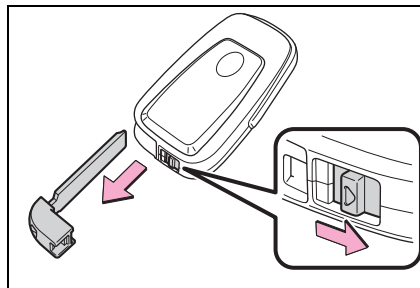

■ **When required to leave the vehicle's key with a parking attendant**

Lock the glove box as circumstances demand. (→P.359)  
Remove the mechanical key for your own use and provide the attendant with the electronic key only.

■ **If you lose your mechanical keys**

→P.479

■ **If a wrong key is used**

The key cylinder rotates freely, isolated from the internal mechanism.

**Side doors**

The vehicle can be locked and unlocked using the entry function, wireless remote control or door lock switches.

**Unlocking and locking the doors from the outside**

■ **Smart key system**

Carry the electronic key to enable this function.

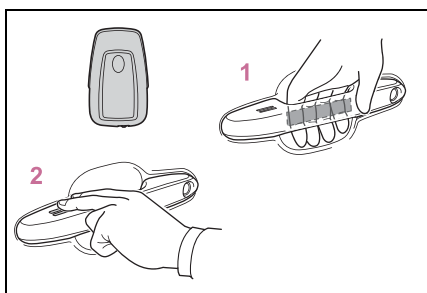

- 1 Grip the driver's door handle to unlock the door. Holding the driver's door handle for approximately 2 seconds unlocks all the doors. Grip the front passenger's door handle to unlock all the doors.\*

Make sure to touch the sensor on the back of the handle.  
The doors cannot be unlocked for 3 seconds after the doors are locked.

\*: The door unlock settings can be changed. (→P.115, 515)

- 2 Touch the lock sensor (the indentation on the upper part

of the front door handle) to lock all the doors.

Check that the door is securely locked.

■ **Wireless remote control**

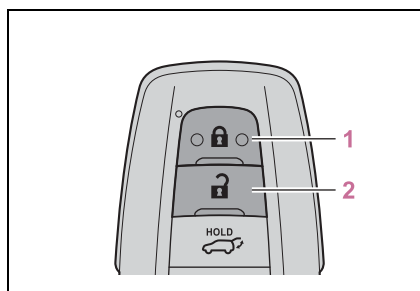

- 1 Locks all the doors  
Check that the door is securely locked.
- 2 Unlocks all the doors  
Pressing the button unlocks the driver's door. Pressing the button again within 5 seconds unlocks the other doors.  
Press and hold to open the windows\*1 and moon roof\*1, 2

\*1: This setting must be customized at your Toyota dealer.

\*2: If equipped

■ **Switching the door unlock function**

It is possible to set which doors the entry function unlocks using the wireless remote control.

- 1 Turn the engine switch off.
- 2 When the indicator light on the key surface is not on, press and hold , or for approximately 5 seconds while pressing and holding .



The setting changes each time an operation is performed, as shown below. (When changing the setting

3

Before driving

## 116 3-2. Opening, closing and locking the doors

continuously, release the buttons, wait for at least 5 seconds, and repeat step 2.)

Multi-information display/Beep	Unlocking function
 <p>Exterior: Beeps 3 times Interior: Pings once</p>	<p>Holding the driver's door handle unlocks only the driver's door.</p>
 <p>Exterior: Beeps twice Interior: Pings once</p>	<p>Holding the front passenger's door handle unlocks all the doors.</p>
 <p>Exterior: Beeps twice Interior: Pings once</p>	<p>Holding either front door handle unlocks all the doors.</p>

For vehicles with an alarm: To prevent unintended triggering of the alarm, unlock the doors using the wireless remote control and open and close a door once after the settings have been changed. (If a door is not opened within 60 seconds after  is pressed, the doors will be locked again and the alarm will automatically be set.)

In case that the alarm is triggered, immediately stop the alarm. (→P.71)

### ■ Impact detection door lock release system

In the event that the vehicle is subject to a strong impact, all the doors are unlocked. Depending on the force of the impact or the type of accident, however, the system may not operate.

### ■ Operation signals

A buzzer sounds and the emergency flashers flash to indicate that the doors have been locked/unlocked. (Locked: Once; Unlocked: Twice)

A buzzer sounds to indicate that the windows and the moon roof\* or panoramic moon roof\* are operating.

\*: If equipped

### ■ Security feature

If a door is not opened within approximately 60 seconds after the vehicle is unlocked, the security feature automatically locks the vehicle again.

### ■ When the door cannot be locked by the lock sensor on the surface of the front door handle

If the door will not lock even when the topside sensor area is touched, try touching both the topside and underside sensor areas at the same time.

When gloves are being worn, remove the gloves.

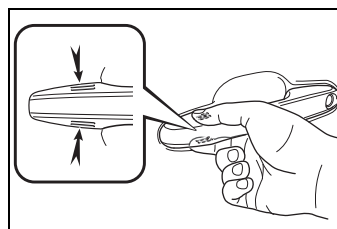

### ■ Door lock buzzer

If an attempt to lock the doors using the smart key system is made when a door is not fully closed, a buzzer will sound continuously for 5 seconds. Fully close the door to stop the buzzer, and lock the doors again.

### ■ Setting the alarm (if equipped)

Locking the doors will set the alarm system. (→P.71)

■ **Conditions affecting the operation of the smart key system or wireless remote control**

→P.132

■ **If the smart key system or the wireless remote control does not operate properly**

Use the mechanical key to lock and unlock the doors. (→P.481)

Replace the key battery with a new one if it is depleted. (→P.428)

■ **If the battery is discharged**

The doors cannot be locked and unlocked using the smart key system or wireless remote control. Lock or unlock the doors using the mechanical key. (→P.481)

■ **Rear seat reminder function**

In order to remind you not to forget luggage, etc. in the rear seat, when the engine switch is turned off after any of the following conditions are met, a buzzer will sound and a message will be displayed on the multi-information display for approximately 6 seconds.

- The engine is started within 10 minutes after opening and closing a rear door.
- A rear door has been opened and closed after the engine was started.

However, if a rear door is opened and then closed within approximately 2 seconds, the rear seat reminder function may not operate.

The rear seat reminder function determines that luggage, etc. has been placed in a rear seat based on opening and closing of a rear door. Therefore, depending on the situation, the rear seat reminder function may not operate and you may still forget luggage, etc. in the rear seat, or it may operate unnecessarily.

The rear seat reminder function can be enabled/disabled. (→P.515)

■ **Customization**

Some functions can be customized. (→P.515)

 **WARNING**

■ **To prevent an accident**

Observe the following precautions while driving the vehicle. Failure to do so may result in a door opening and an occupant falling out, resulting in death or serious injury.

- Ensure that all doors are properly closed and locked.
- Do not pull the inside handle of the doors while driving.

Be especially careful for the front doors, as the doors may be opened even if the inside lock buttons are in locked position.

- Set the rear door child-protector locks when children are seated in the rear seats.

■ **When opening or closing a door**

Check the surroundings of the vehicle such as whether the vehicle is on an incline, whether there is enough space for a door to open and whether a strong wind is blowing. When opening or closing the door, hold the door handle tightly to prepare for any unpredictable movement.

**Unlocking and locking the doors from the inside**

■ **Door lock switches**

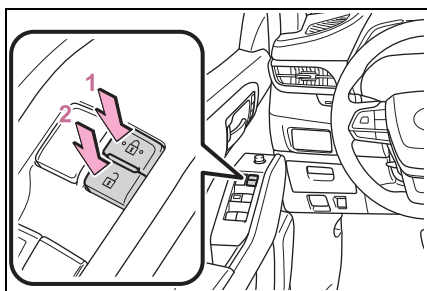

- 1** Locks all the doors
- 2** Unlocks all the doors

■ **Inside lock buttons**

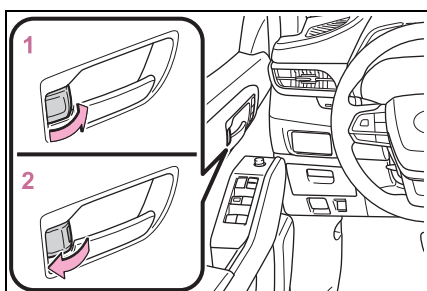

- 1** Locks the door
- 2** Unlocks the door

The front doors can be opened by pulling the inside handle even if the lock buttons are in the lock position.

■ **Locking the front doors from the outside without a key**

- 1** Move the inside lock button to the lock position.
- 2** Close the door.

The door cannot be locked if the engine switch is in ACC or ON, or the electronic key is left inside the vehicle.

The key may not be detected correctly and the door may be locked.

■ **Open door warning buzzer**

If a door or the hood is not fully closed, a buzzer will sound when the vehicle speed reaches 3 mph (5 km/h).

The open door(s) or hood is displayed on the multi-information display.

**Rear door child-protector lock**

The door cannot be opened from inside the vehicle when the lock is set.

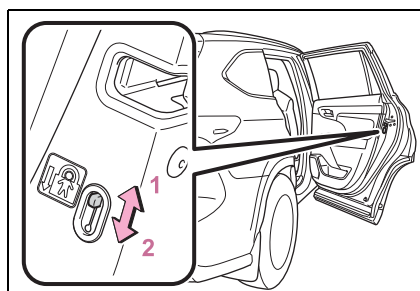

- 1** Unlock
- 2** Lock

These locks can be set to prevent children from opening the rear doors. Push down on each rear door switch to lock both rear doors.

**Automatic door locking and unlocking systems**

The following functions can be set or canceled:

For instructions on customizing, refer to P.515.

Function	Operation
Speed linked door locking function	All doors are automatically locked when vehicle speed is approximately 12 mph (20 km/h) or higher.
Shift position linked door locking function	All doors are automatically locked when shifting the shift lever out of P.
Shift position linked door unlocking function	All doors are automatically unlocked when shifting the shift lever to P.
Driver's door linked door unlocking function	All doors are automatically unlocked when driver's door is opened.

**Back door**

**The back door can be locked/unlocked and opened/closed by the following procedures.**

**⚠ WARNING**

Observe the following precautions. Failure to do so may result in death or serious injury.

■ **Before driving the vehicle**  
 Before driving the vehicle, make sure that the back door is fully closed. If the back door is not fully closed, it may open unexpectedly while driving, causing an accident.

■ **Caution while driving**

- Keep the back door closed while driving.

If the back door is left open, it may hit near-by objects while driving or luggage may be unexpectedly thrown out, causing an accident.

In addition, exhaust gases may enter the vehicle, causing death or a serious health hazard. Make sure to close the back door before driving.

- Never let anyone sit in the luggage compartment. In the event of sudden braking, sudden swerving or a collision, they are susceptible to death or serious injury.

■ **When children are in the vehicle**

- Do not allow children to play in the luggage compartment.

If a child is accidentally locked in the luggage compartment, they could have heat exhaustion or other injuries.

**⚠ WARNING**

- Do not allow a child to open or close the back door.

Doing so may cause the back door to move unexpectedly, or cause the child's hands, arms, head, or neck to be caught by the closing back door.

**■ Operating the back door**

Observe the following precautions. Failure to do so may cause parts of the body to be caught, resulting in death or serious injury.

- Remove any heavy loads, such as snow and ice, from the back door before opening it. Failure to do so may cause the back door to suddenly shut again after it is opened.
- When opening or closing the back door, thoroughly check to make sure the surrounding area is safe.
- If anyone is in the vicinity, make sure they are safe and let them know that the back door is about to open or close.
- Use caution when opening or closing the back door in windy weather as it may move abruptly in strong wind.

- Vehicles without a power back door: The back door may suddenly shut if it is not opened fully. It is more difficult to open or close the back door on an incline than on a level surface, so beware of the back door unexpectedly opening or closing by itself. Make sure that the back door is fully open and secure before using the luggage compartment.

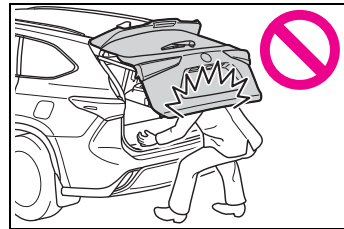

- Vehicles with a power back door: The back door may suddenly shut if it is not opened fully while on a steep incline. Make sure that the back door is secured before using the luggage compartment.
- When closing the back door, take extra care to prevent your fingers, etc., from being caught.

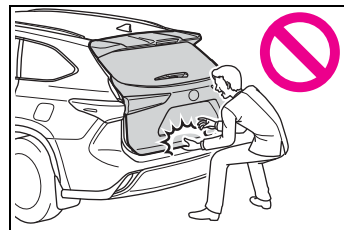

- When closing the back door, make sure to press it lightly on its outer surface. If the back door handle is used to fully close the back door, it may result in hands or arms being caught.



**⚠ WARNING**

- Do not pull on the back door damper stay (vehicles without a power back door) (→P.122) or back door spindle (vehicles with a power back door) (→P.128) to close the back door, and do not hang on the back door damper stay (vehicles without a power back door) or back door spindle (vehicles with a power back door).

Doing so may cause hands to be caught or the back door damper stay (vehicles without a power back door) or back door spindle (vehicles with a power back door) to break, causing an accident.

- If a heavy object is attached to the back door, it may suddenly shut again after being opened, causing someone's hands, arms, head or neck to be caught and injured. Do not attach any accessories other than genuine Toyota parts to the back door.

**Unlocking and locking the back door from the outside**

■ **Smart key system**

Carry the electronic key to enable this function.

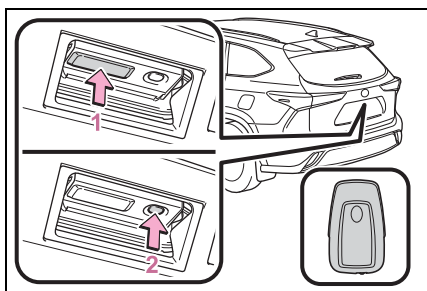

**1** Unlocks all the doors

The doors cannot be unlocked for 3 seconds after the doors are locked.

**2** Locks all the doors

Check that the door is securely locked.

■ **Wireless remote control**

→P.115

■ **Operation signals**

→P.116

**Unlocking and locking the back door from the inside**

■ **Door lock switches**

→P.118

**Opening/closing the back door (vehicles without a power back door)**

■ **Opening the back door**

Raise the back door while pushing up the back door opener switch.

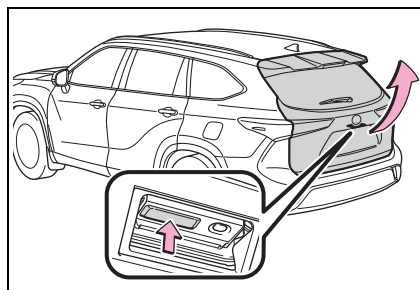

■ **Closing the back door**

Lower the back door using a back door handle, and then push the back door from the outside to close it.

3

Before driving

## 122 3-2. Opening, closing and locking the doors

Be careful not to pull the back door sideways when using a handle.

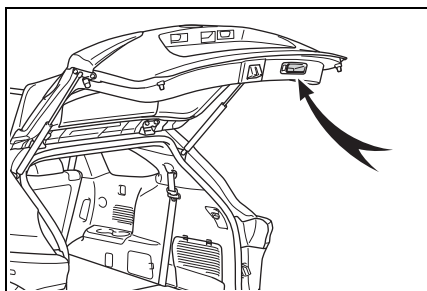

### ■ Open door warning buzzer

→P.118

### ⚠ NOTICE

#### ■ Back door damper stays

The back door is equipped with damper stays that hold the back door in place.

Observe the following precautions. Failure to do so may cause damage to the back door damper stay, resulting in malfunction.

- Do not attach any foreign objects, such as stickers, plastic sheets, or adhesives to the damper stay rod.

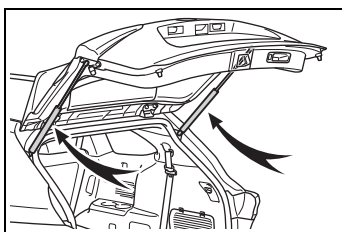

- Do not touch the damper stay rod with gloves or other fabric items.
- Do not attach any accessories other than genuine Toyota parts to the back door.

- Do not place your hand on the damper stay or apply lateral forces to it.

### Opening/closing the back door (vehicles with a power back door)

#### ■ Opening/closing the back door using the wireless remote control

Press and hold the switch.

Pressing the switch while the back door is opening/closing will stop the operation. Pressing and holding the switch again will operate the back door in the opposite direction.

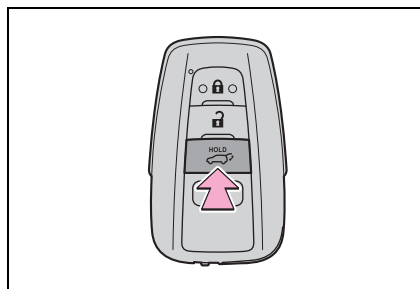

#### ■ Opening/closing the back door using the power back door switch on the instrument panel

Press and hold the switch.

Unlock the back door before operating.

Pressing the switch while the back door is opening/closing will stop the operation. Pressing and holding the switch again will operate the back door in the opposite direction.

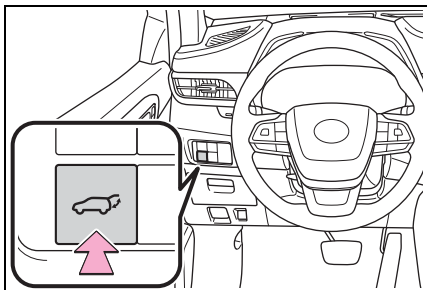

■ **Opening the back door using the back door opener switch**

When the back door is unlocked: Press the back door opener switch.

When the back door is locked: While carrying the electronic key on your person, press the back door opener switch.

Pressing the switch while the back door is opening/closing will stop the operation. Pressing the switch again will open the back door.

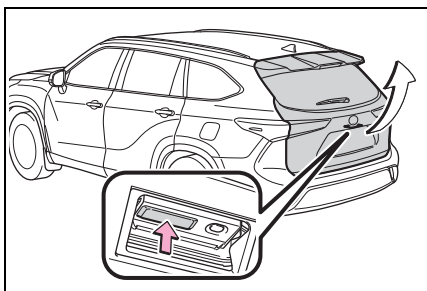

■ **Opening/closing the back door using the power back door switch on the back door**

Press the switch.

Pressing the switch while the back door is opening/closing will stop the operation. Pressing the switch

again will operate the back door in the opposite direction.

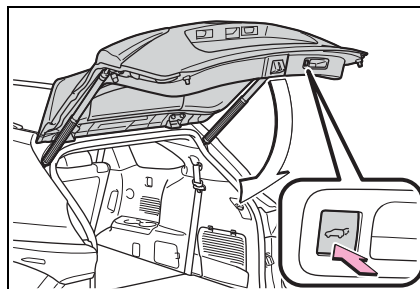

■ **Closing the back door using the back door handle**

Lower the back door using the back door handle, then a buzzer sounds and the back door automatically closes.

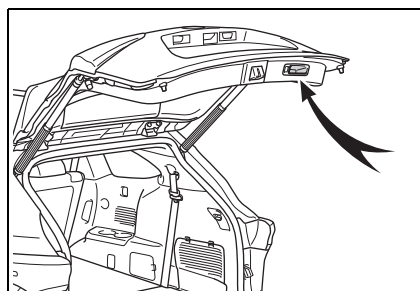

■ **Opening/closing the back door using the kick sensor (vehicles with a Hands Free Power Back Door)**

The Hands Free Power Back Door enables automatic opening and closing of the power back door by putting your foot near the lower center part of the rear bumper and moving it away from the rear bumper.

- 1 While carrying an electronic key, stand within the smart key system operation range,

approximately 13.8 to 21.7 in.  
(35 to 55 cm) from the rear  
bumper.

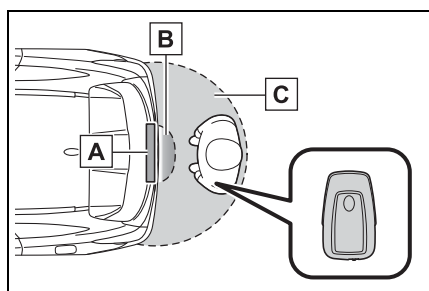

- A** Kick sensor
- B** Hands Free Power Back Door operation detection area
- C** Smart key system operation detection area (→P.131)

- 2** Perform a kick operation by moving your foot to within approximately 3.9 in. (10 cm) of the rear bumper and then pulling it back.
  - Perform the entire kick operation within 1 second.
  - The back door will not start operating while a foot is detected under the rear bumper.
  - Operate the Hands Free Power Back Door without contacting the rear bumper with your foot.
  - If another electronic key is in the cabin or luggage compartment, it may take slightly longer than normal for the

operation to occur.

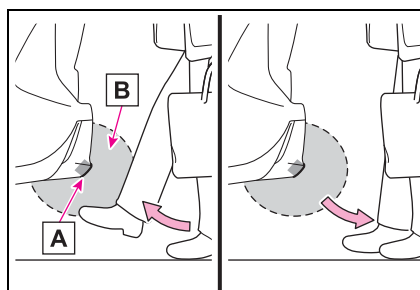

- A** Kick sensor
  - B** Hands Free Power Back Door operation detection area
- 3** When the sensor detects that your foot is pulled back, a buzzer will sound and the back door will automatically fully open/close.

If kick operation is performed while the back door is opening/closing, the back door will stop the operation. Perform a kick operation again will operate the back door in the opposite direction.

#### ■ Back door closer

In the event that the back door is left slightly open, the back door closer will automatically close it to the fully closed position.

- The back door closer can function when the engine switch is in any mode.
- The back door can be opened using the back door opener switch even if the back door closer is operating.

#### ■ Power back door operating conditions

If the following conditions are met, the power back door can be opened and closed automatically.

- When the power back door sys-

tem is enabled. (→P.515)

- When the engine switch is in ON, one of the following conditions must be met in addition to the above conditions:
  - The parking brake is engaged.
  - The brake pedal is depressed.
  - The shift lever is in P.

■ **Operation of the power back door**

- When the power back door begins to operate, the emergency flashers will flash twice and a buzzer will sound.
- When the power back door is disabled, the power back door will not operate but can be opened and closed manually.
- When the power back door is opening/closing, if the power back door becomes obstructed, operation will stop.

■ **Jam protection function**

Sensors are installed on the right and left sides of the power back door. When the door is automatically closing and the sensors are pushed due to an object being clamped, etc., the jam protection function operates.

From that position the door automatically moves a little in the opposite direction and then the function stops.

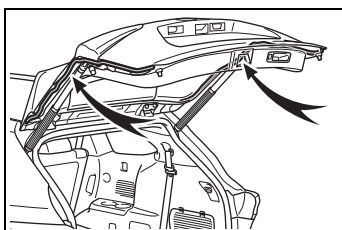

■ **Back door reserve lock function**

This function reserves the locking of the power back door when the power back door is open. If the following operations are performed, all of the doors except the power back door will lock and then the power

back door will lock when it is completely closed.

- 1 Close all of the doors, except the back door.
- 2 Perform an automatic closing operation of the power back door and lock the doors using the wireless remote control (→P.115) or smart key system (→P.115) while the power back door is closing.

A buzzer sounds and the emergency flashers flash to indicate that all the doors have been closed and locked.

- If the electronic key is placed inside the vehicle after starting a close operation via the door reserve lock function, the electronic key may become locked inside the vehicle.
- If the back door does not fully close due to the operation of the jam protection function, etc., while the back door is automatically closing after a door reserve lock operation is performed, the door reserve lock function is canceled and all the doors will unlock.
- Before leaving the vehicle, make sure that all the doors are closed and locked.

■ **Kick sensor operating conditions (vehicles with a Hands Free Power Back Door)**

- When the kick sensor operation setting is turned on (→P.515) and the engine switch is turned off.
- When an electronic key is carried within the operation detection area.

■ **Situations in which the Hands Free Power Back Door may not operate properly (if equipped)**

In the following situations, the Hands Free Power Back Door may not operate properly:

- When a foot remains under the rear bumper.

## 126 3-2. Opening, closing and locking the doors

---

- If the rear bumper is strongly hit with a foot or is touched for a while.

If the rear bumper has been touched for a while, wait for a short time before attempting to operate the Hands Free Power Back Door again.

- When standing excessively close to the rear bumper.
- When an external radio wave source interferes with the communication between the electronic key and the vehicle. (→P.132)
- When the vehicle is parked near an electrical noise source which affects the sensitivity of the Hands Free Power Back Door, such as a pay parking spot, gas station, electrically heated road, or fluorescent light.
- When the vehicle is near a TV tower, electric power plant, radio station, large display, airport or other facility that generates strong radio waves or electrical noise.
- When a large amount of water is applied to the rear bumper, such as when the vehicle is being washed or in heavy rain.
- When mud, snow, ice, etc. is attached to the rear bumper.
- When the vehicle has been parked for a while near objects that may move and contact the rear bumper, such as plants.
- When an accessory is installed to the rear bumper.

If an accessory has been installed, turn the kick sensor operation setting off. (→P.515)

### ■ Preventing unintentional operation of the Hands Free Power Back Door (if equipped)

When an electronic key is in the operation detection area, the Hands Free Power Back Door may operate unintentionally, so be careful in the following situations:

- When a large amount of water is applied to the rear bumper, such as when the vehicle is being washed or in heavy rain.
- When dirt is wiped off the rear bumper.
- When a small animal or small object, such as a ball, moves under the rear bumper.
- When an object is moved from under the rear bumper.
- If someone is swinging their legs while sitting on the rear bumper.
- If the legs or another part of someone's body contacts the rear bumper while passing by the vehicle.
- When the vehicle is parked near an electrical noise source which affects the sensitivity of the Hands Free Power Back Door, such as a pay parking spot, gas station, electrically heated road, or fluorescent light.
- When the vehicle is near a TV tower, electric power plant, radio station, large display, airport or other facility that generates strong radio waves or electrical noise.
- When the vehicle is parked in a place where objects such as plants are near the rear bumper.
- When luggage, etc. is set in or removed from the luggage compartment from outside of the vehicle.
- If accessories or a vehicle cover is installed/removed near the rear bumper.
- When snow attached to the inner side of the rear bumper melts.

To prevent unintentional operation, turn the kick sensor operation setting off. (→P.515)

### ■ When reconnecting the battery

To enable the power back door to operate properly, close the back door manually.

■ **Customization**

Some functions can be customized.  
(→P.515)

 **WARNING**

■ **Back door closer**

- In the event that the back door is left slightly open, the back door closer will automatically close it to the fully closed position. It takes several seconds before the back door closer begins to operate. Be careful not to get fingers caught or anything else in the back door, as this may cause bone fractures or other serious injuries.

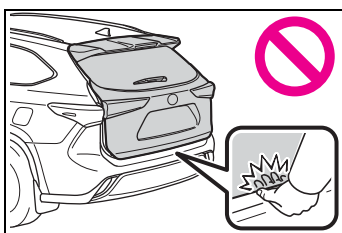

- Use caution when using the back door closer as it still operates when the power back door system is disabled.

■ **Power back door**

Observe the following precautions when operating the power back door. Failure to do so may cause death or serious injury.

- Check the safety of the surrounding area to make sure there are no obstacles or anything that could cause any of your belongings to get caught.
- If anyone is in the vicinity, make sure they are safe and let them know that the back door is about to open or close.

- If the power back door system is disabled while the power back door is operating, the back door will stop operating. The back door must then be operated manually. Take extra care in this situation, as the back door may open or close suddenly.

- If the operating conditions of the power back door (→P.124) are no longer met, a buzzer may sound and the back door may stop opening or closing. The back door must then be operated manually. Take extra care on an incline in this situation, as the back door may move suddenly.

- On an incline, the back door may suddenly shut after it opens. Make sure the back door is fully open and secure.

- In the following situations, the power back door may detect an abnormality and automatic operation may be stopped. In this case, the back door must then be operated manually. Take extra care in this situation, as the stopped back door may suddenly open or close, causing an accident.

- When the back door contacts an obstacle
- When the battery voltage suddenly drops, such as when the engine switch is turned to ON or the engine is started during automatic operation

**⚠ WARNING**

- If a heavy object is attached to the back door, the back door may not operate, causing a malfunction, or the back door may suddenly shut again after being opened, causing someone's hands, arms, head or neck to be caught and injured. Do not attach any accessories other than genuine Toyota parts to the back door.

**■ Jam protection function**

Observe the following precautions. Failure to do so may cause death or serious injury.

- Never use any part of your body to intentionally activate the jam protection function.
- The jam protection function may not work if something gets caught just before the back door fully closes. Be careful not to get fingers caught or anything else.
- The jam protection function may not work depending on the shape of the object that is caught. Be careful not to catch fingers or anything else.

**■ Hands Free Power Back Door (if equipped)**

Observe the following precautions when operating the Hands Free Power Back Door. Failure to do so may cause death or serious injury.

- Check the safety of the surrounding area to make sure there are no obstacles or anything that could cause any of your belongings to get caught.

- Exhaust gasses cause the exhaust pipes to become quite hot. When operating the Hands Free Power Back Door, be careful not to touch the exhaust pipe.

- Do not operate the Hands Free Power Back Door if there is little space under the rear bumper.

**⚠ NOTICE**

**■ Back door spindles**

The back door is equipped with spindles that hold the back door in place.

Observe the following precautions. Failure to do so may cause damage to the back door spindle, resulting in malfunction.

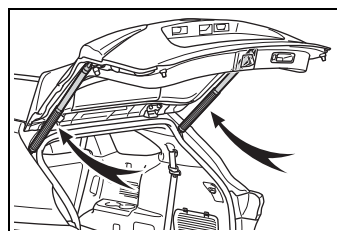

- Do not attach any foreign objects, such as stickers, plastic sheets, or adhesives to the spindle rod.
- Do not attach any accessories other than genuine Toyota parts to the back door.
- Do not place your hand on the spindle or apply lateral forces to it.

**■ To prevent back door closer malfunction**

Do not apply excessive force to the back door while the back door closer is operating. Applying excessive force may cause the back door closer to malfunction.



 **NOTICE**

■ **To prevent malfunction of the power back door**

- Make sure that there is no ice between the back door and frame that would prevent movement of the back door. Operating the power back door when excessive load is present on the back door may cause a malfunction.
- Do not apply excessive force to the power back door while the back door is operating.
- Take care not to damage the sensors (installed on the right and left edges of the power back door) with a knife or other sharp object. If a sensor is disconnected, the power back door will not close automatically.

■ **Hands Free Power Back Door precautions (if equipped)**

The kick sensor is located behind lower center part of the rear bumper. Observe the following to ensure that the Hands Free Power Back Door function operates properly:

- Keep the lower center part of the rear bumper clean at all times.

If the lower center part of the rear bumper is dirty or covered with snow, the kick sensor may not operate. In this situation, clean off the dirt or snow, move the vehicle from the current position and then check if the kick sensor operates. If it does not operate, have the vehicle inspected by your Toyota dealer.

- Do not apply coatings that have a rain clearing (hydrophilic) effect, or other coatings, to the lower center part of the rear bumper.

- Do not park the vehicle near objects that may move and contact the lower center part of the rear bumper, such as grass or trees.

If the vehicle has been parked for a while near objects that may move and contact the lower center part of the rear bumper, such as grass or trees, the kick sensor may not operate. In this situation, move the vehicle from the current position and then check if the kick sensor operates. If it does not operate, have the vehicle inspected by your Toyota dealer.

- Do not subject the kick sensor or its surrounding area to a strong impact.

If the kick sensor or its surrounding area has been subjected to a strong impact, the kick sensor may not operate properly.

If the kick sensor does not operate in the following situations, have the vehicle inspected by your Toyota dealer.

- The kick sensor or its surrounding area has been subjected to a strong impact.
- The lower center part of the rear bumper is scratched or damaged.

- Do not disassemble the rear bumper.
- Do not attach stickers to the rear bumper.
- Do not paint the rear bumper.
- If a heavy object is attached to the power back door, disable the kick sensor.

**Adjusting the open position of the back door (vehicles with a power back door)**

The open position of the power back door can be adjusted.

- 1 Stop the power back door at the desired position.  
(→P.122)
- 2 Press and hold the power back door switch on the back door for approximately 2 seconds.
  - When setting is complete, a buzzer will sound 4 times.
  - The next time the power back door is opened, it will stop at that position.

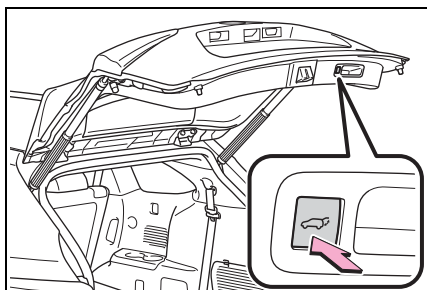

**Returning the power back door opening position to the default setting**

Press and hold the power back door switch on the back door for approximately 7 seconds.

A buzzer will sound 4 times, pause, and then sound 2 more times. The next time the power back door is opened, it will stop at the default position.

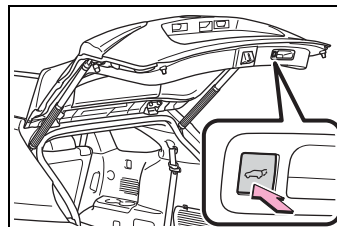

**When setting the open position of the back door by the multi-information display**

The open position of the power back door can be adjusted using the multi-information display. (→P.515)

When opened, the power back door will open to the last position set using the power back door switch on the back door or on the multi-information display.

**Smart key system**

The following operations can be performed simply by carrying the electronic key on your person, for example in your pocket. The driver should always carry the electronic key.

- Locks and unlocks the doors (→P.115)
- Locks and unlocks the back door (→P.121)
- Starts and stops the engine (→P.200)

■ **Antenna location**

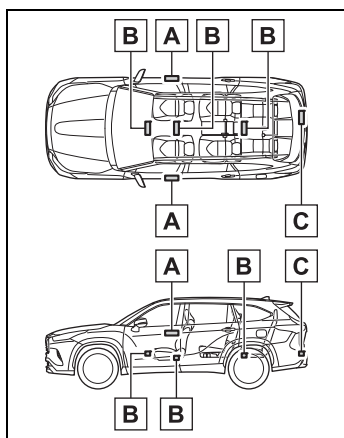

- A** Antennas outside the cabin
- B** Antennas inside the cabin
- C** Antenna outside the luggage compartment

■ **Effective range (areas within which the electronic key is detected)**

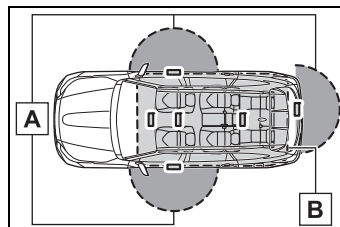

- A** When locking or unlocking the doors

The system can be operated when the electronic key is within about 2.3 ft. (0.7 m) of an outside front door handle and back door. (Only the doors detecting the key can be operated.)

- B** When starting the engine or changing engine switch modes

The system can be operated when the electronic key is inside the vehicle.

■ **Alarms and warning messages**

A combination of exterior and interior alarms as well as warning messages shown on the multi-information display are used to prevent theft of the vehicle and accidents resulting from erroneous operation. Take appropriate measures in response to any warning message on the multi-information display. (→P.460)

When only an alarm sounds, circumstances and correction procedures are as follows.

- When an exterior alarm sounds once for 5 seconds

Situation	Correction procedure
An attempt was made to lock the vehicle while a door was open.	Close all of the doors and lock the doors again.

- When an interior alarm sounds continuously

Situation	Correction procedure
The engine switch was turned to ACC while the driver's door was open (or the driver's door was opened while the engine switch was in ACC).	Turn the engine switch off and close the driver's door.
The engine switch was turned off while the driver's door was open.	Close the driver's door.

■ **Battery-saving function**



The battery-saving function will be activated in order to prevent the electronic key battery and the vehicle battery from being discharged while the vehicle is not operated for a long time.

- In the following situations, the smart key system may take some time to unlock the doors.
  - The electronic key has been left in an area of approximately 6 ft. (2 m) of the outside of the vehicle for 10 minutes or longer.
  - The smart key system has not been used for 5 days or longer.
  - If the smart key system has not been used for 14 days or longer, the doors cannot be unlocked at any doors except the driver's door. In this case, take hold of the driver's door handle, or use the

wireless remote control or the mechanical key, to unlock the doors.

■ **Turning an electronic key to battery-saving mode**

When battery-saving mode is set, battery depletion is minimized by stopping the electronic key from receiving radio waves.

Press  twice while pressing and holding . Confirm that the electronic key indicator flashes 4 times.

While the battery-saving mode is set, the smart key system cannot be used. To cancel the function, press any of the electronic key buttons.



■ **Conditions affecting operation**

The smart key system uses weak radio waves. In the following situations, the communication between the electronic key and the vehicle may be affected, preventing the smart key system, wireless remote control and engine immobilizer system from operating properly. (Ways of coping:→P.481)

- When the electronic key battery is depleted
- Near a TV tower, electric power plant, gas station, radio station, large display, airport or other facility that generates strong radio waves or electrical noise
- When the electronic key is in contact with, or is covered by the following metallic objects
  - Cards to which aluminum foil is attached
  - Cigarette boxes that have aluminum foil inside

- Metallic wallets or bags
- Coins
- Hand warmers made of metal
- Media such as CDs and DVDs
- When other wireless keys (that emit radio waves) are being used nearby
- When carrying the electronic key together with the following devices that emit radio waves
  - Portable radio, cellular phone, cordless phone or other wireless communication devices
  - Another electronic key or a wireless key that emits radio waves
  - Personal computers or personal digital assistants (PDAs)
  - Digital audio players
  - Portable game systems
- If window tint with a metallic content or metallic objects are attached to the rear window
- When the electronic key is placed near a battery charger or electronic devices
- When the vehicle is parked in a pay parking spot where radio waves are emitted

■ **Note for the entry function**

- Even when the electronic key is within the effective range (detection areas), the system may not operate properly in the following cases:
  - The electronic key is too close to the window or outside door handle, near the ground, or in a high place when the doors are locked or unlocked.
  - The electronic key is on the instrument panel, luggage compartment, floor, or in the door pockets or glove box when the engine is started or engine switch modes are changed.
  - Do not leave the electronic key on top of the instrument panel or near the door pockets when exiting the vehicle. Depending on the radio wave reception conditions, it may be detected by the antenna out-

side the cabin and the door will become lockable from the outside, possibly trapping the electronic key inside the vehicle.

- As long as the electronic key is within the effective range, the doors may be locked or unlocked by anyone. However, only the doors detecting the electronic key can be used to unlock the vehicle.
- Even if the electronic key is not inside the vehicle, it may be possible to start the engine if the electronic key is near the window.
- The doors may unlock or lock if a large amount of water splashes on the door handle, such as in the rain or in a car wash when the electronic key is within the effective range. (The doors will automatically be locked after approximately 60 seconds if the doors are not opened and closed.)
- If the wireless remote control is used to lock the doors when the electronic key is near the vehicle, there is a possibility that the door may not be unlocked by the entry function. (Use the wireless remote control to unlock the doors.)
- Touching the door lock or unlock sensor while wearing gloves may prevent lock or unlock operation.
- When the lock operation is performed using the lock sensor, recognition signals will be shown up to two consecutive times. After this, no recognition signals will be given.
- If the door handle becomes wet while the electronic key is within the effective range, the door may lock and unlock repeatedly. In that case, follow the following correction procedures to wash the vehicle:
  - Place the electronic key in a location 6 ft. (2 m) or more away from the vehicle. (Take care to ensure that the key is not stolen.)
  - Set the electronic key to bat-

## 134 3-2. Opening, closing and locking the doors

---

tery-saving mode to disable the smart key system. (→P.132)

- If the electronic key is inside the vehicle and a door handle becomes wet during a car wash, a message may be shown on the multi-information display and a buzzer will sound outside the vehicle. To turn off the alarm, lock all the doors.
- The lock sensor may not work properly if it comes into contact with ice, snow, mud, etc. Clean the lock sensor and attempt to operate it again, or use the lock sensor on the lower part of the door handle.
- A sudden handle operation or a handle operation immediately after entering the effective range may prevent the doors from being unlocked. Touch the door unlock sensor and check that the doors are unlocked before pulling the door handle again.
- If there is another electronic key in the detection area, it may take slightly longer to unlock the doors after the door handle is gripped.

### ■ When the vehicle is not driven for extended periods

- To prevent theft of the vehicle, do not leave the electronic key within 6 ft. (2 m) of the vehicle.
- The smart key system can be deactivated in advance. (→P.515)
- Setting the electronic key to battery-saving mode helps to reduce key battery depletion. (→P.132)

### ■ To operate the system properly

Make sure to carry the electronic key when operating the system. Do not get the electronic key too close to the vehicle when operating the system from the outside of the vehicle.

Depending on the position and holding condition of the electronic key, the key may not be detected cor-

rectly and the system may not operate properly. (The alarm may go off accidentally, or the door lock prevention may not operate.)

### ■ If the smart key system does not operate properly

If the doors cannot be locked/unlocked using the smart key system, lock/unlock the doors by performing any of the following:

- Bring the electronic key close to either front door handle and operate the entry function.
- Operate the wireless remote control.

If the doors cannot be locked/unlocked using the above methods, use the mechanical key. (→P.481)

If the engine cannot be started using the smart key system, refer to P.482.

### ■ Customization

Some functions can be customized. (→P.515)

### ■ If the smart key system has been deactivated in a customized setting

- Locking and unlocking the doors: Use the wireless remote control or mechanical key. (→P.115, 481)
- Starting the engine and changing engine switch modes: →P.482
- Stopping the engine: →P.201

■ **Certification for the smart key system**

- ▶ For vehicles sold in the U.S.A.

FCC ID:NI4TMLF15-1

This device complies with part 15 of the FCC Rules. Operation is subject to the following two conditions: (1) This device may not cause harmful interference, and (2) this device must accept any interference received, including interference that may cause undesired operation.

Changes or modifications not expressly approved by the party responsible for compliance could void the user's authority to operate the equipment.

FCC ID:HYQ14FBC

**NOTE:**

This device complies with part 15 of the FCC Rules. Operation is subject to the following two conditions: (1) This device may not cause harmful interference, and (2) this device must accept any interference received, including interference that may cause undesired operation.

**FCC WARNING:**

Changes or modifications not expressly approved by the party responsible for compliance could void the user's authority to operate the equipment.

## 136 3-2. Opening, closing and locking the doors

---

- For vehicles sold in Canada

This device complies with Industry Canada's licence-exempt RSSs. Operation is subject to the following two conditions: (1) This device may not cause interference; and (2) This device must accept any interference, including interference that may cause undesired operation of the device.

Le présent appareil est conforme aux CNR d'Industrie Canada applicables aux appareils radio exempts de licence. L'exploitation est autorisée aux deux conditions suivantes : 1) l'appareil ne doit pas produire de brouillage; 2) l'utilisateur de l'appareil doit accepter tout brouillage radioélectrique subi, même si le brouillage est susceptible d'en compromettre le fonctionnement.

**NOTE:**

This device complies with Industry Canada's licence-exempt RSSs. Operation is subject to the following two conditions:

- (1) This device may not cause interference; and
- (2) This device must accept any interference, including interference that may cause undesired operation of the device.

**NOTE:**

Le présent appareil est conforme aux CNR d'Industrie Canada applicables aux appareils radio exempts de licence. L'exploitation est autorisée aux deux conditions suivantes:

- (1) l'appareil ne doit pas produire de brouillage;
- (2) l'utilisateur de l'appareil doit accepter tout brouillage radioélectrique subi, même si le brouillage est susceptible d'en compromettre le fonctionnement.



 **WARNING****■ Caution regarding interference with electronic devices**

- People with implantable cardiac pacemakers, cardiac resynchronization therapy-pacemakers or implantable cardioverter defibrillators should keep away from the smart key system antennas. (→P.131) The radio waves may affect the operation of such devices. If necessary, the entry function can be disabled. Ask your Toyota dealer for details, such as the frequency of radio waves and timing of the emitted radio waves. Then, consult your doctor to see if you should disable the entry function.
- Users of any electrical medical device other than implantable cardiac pacemakers, cardiac resynchronization therapy-pacemakers or implantable cardioverter defibrillators should consult the manufacturer of the device for information about its operation under the influence of radio waves. Radio waves could have unexpected effects on the operation of such medical devices.

Ask your Toyota dealer for details on disabling the entry function.

**Front seats**

**Adjustment procedure**

► Manual seat

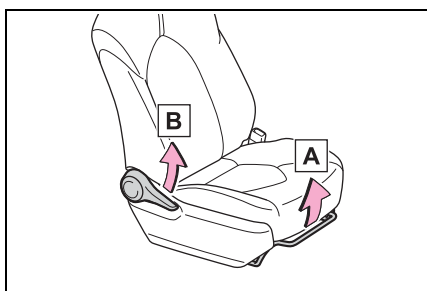

- A** Seat position adjustment lever
- B** Seatback angle adjustment lever

► Power seat

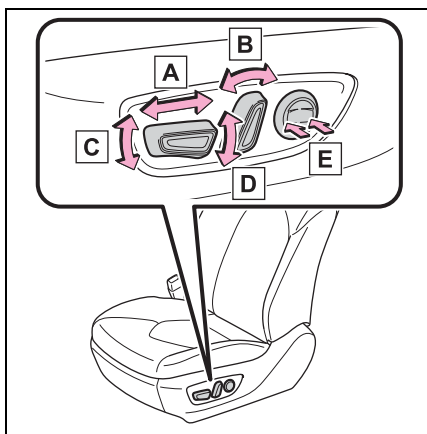

- A** Seat position adjustment switch
- B** Seatback angle adjustment switch
- C** Seat cushion (front) angle adjustment switch (driver's side only)

- D** Vertical height adjustment switch (driver's side only)
- E** Lumbar support adjustment switch (driver's side only)

■ **When adjusting the seat**

Take care when adjusting the seat so that the head restraint does not touch the ceiling.

**⚠ WARNING**

■ **When adjusting the seat position**

- Take care when adjusting the seat position to ensure that other passengers are not injured by the moving seat.
- Do not put your hands under the seat or near the moving parts to avoid injury. Fingers or hands may become jammed in the seat mechanism.
- Make sure to leave enough space around the feet so they do not get stuck.

■ **Seat adjustment**

- Be careful that the seat does not hit passengers or luggage.
- To reduce the risk of sliding under the lap belt during a collision, do not recline the seat more than necessary.

If the seat is too reclined, the lap belt may slide past the hips and apply restraint forces directly to the abdomen, or your neck may contact the shoulder belt, increasing the risk of death or serious injury in the event of an accident.

Adjustments should not be made while driving as the seat may unexpectedly move and cause the driver to lose control of the vehicle.

**⚠ WARNING**

- Manual seat only: After adjusting the seat, make sure that the seat is locked in position.

**Rear seats**

**The seat position and seat-back angle can be adjusted, and the seatback can be folded by operating a seat-back angle adjustment lever.**

**⚠ WARNING**

**■ Seat adjustment**

- To reduce the risk of sliding under the lap belt during a collision, do not recline the seat more than necessary.

If the seat is too reclined, the lap belt may slide past the hips and apply restraint forces directly to the abdomen, or your neck may contact the shoulder belt, increasing the risk of death or serious injury in the event of an accident.

Adjustments should not be made while driving as the seat may unexpectedly move and cause the driver to lose control of the vehicle.

- Be careful that the seat does not hit passengers or luggage.
- Be careful not to get your hands or feet caught in the seat.

**■ After adjusting or returning the seats**

Observe the following precautions. Failure to do so may result in death or serious injury.

- Make sure that the seat and seatback are securely locked in position by lightly rocking them back and forth.
- Check that the seat belts are not twisted or caught in the seatback.

**3**

Before driving

**⚠ WARNING**

**■ When folding the rear seatbacks down**

Observe the following precautions. Failure to do so may result in death or serious injury.

- Do not fold the seatbacks down while driving.
- Stop the vehicle on level ground, set the parking brake and shift the shift lever to P.
- Do not allow anyone to sit on a folded seatback or in the luggage compartment while driving.
- Do not allow children to enter the luggage compartment.
- Do not fold down a rear seatback when there are passengers sitting in the rear seats or when there is luggage placed on the rear seats.
- Be careful not to catch your hand when folding the rear seatbacks.

**Adjustment procedure**

■ **Second seats**

▶ **8-seat models**

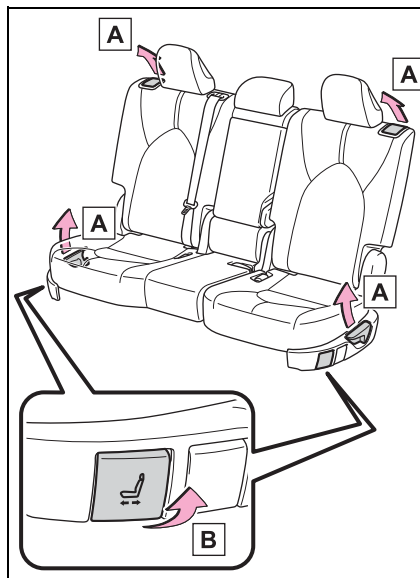

**A** Seatback angle adjustment lever

**B** Seat position adjustment lever

► 7-seat models

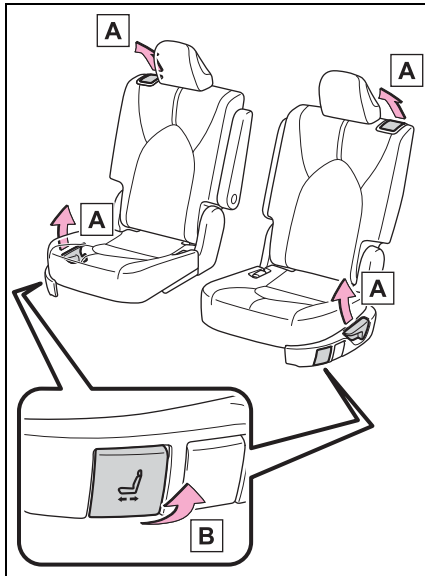

- A** Seatback angle adjustment lever
- B** Seat position adjustment lever

■ Third seats

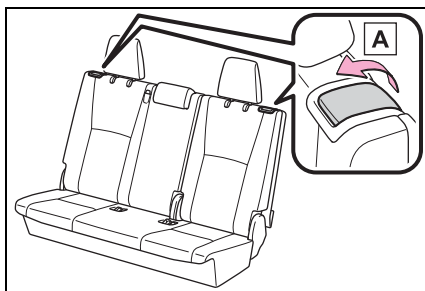

- A** Seatback angle adjustment lever

**Moving a second seat for third seat access**

■ When entering/exiting the vehicle

Pull the seatback angle adjustment lever **A** or **B** to tilt the seatback forward and then slide the seat forward.

Make sure that the second seat is free of passengers and obstructions before operating the lever.

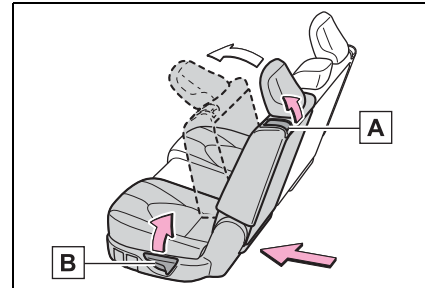

■ After passengers have entered/exited the vehicle

Lift up the seatback and slide the seat backward until it locks.

**Folding down the second seats**

■ Before folding down the second seats

- 1 Stow the armrest. (→P.375)

3

Before driving

**142** 3-3. Adjusting the seats

- 2** Stow the second seat belt buckles.

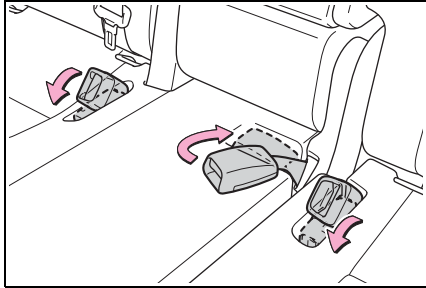

- 3** Pass the outer seat belts through the seat belt hangers and secure the seat belt plates.

This prevents the shoulder belts from being damaged.

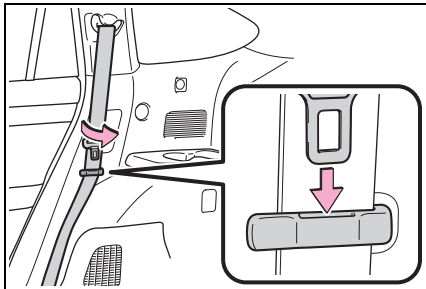

- 4** Lower the head restraints to the lowest position. (→P.147)

■ **Folding down the second seats**

- 1** Pull the seatback angle adjustment lever **A** or **B** to tilt the seatback forward.

Each seatback may be folded sep-

arately.

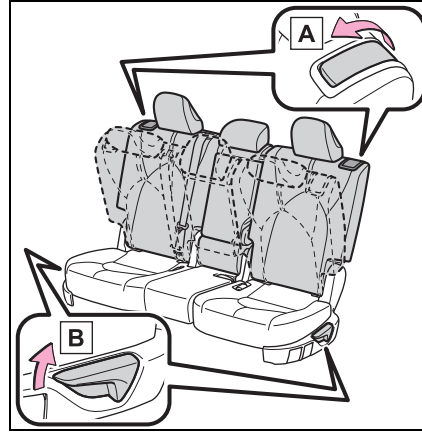

- 2** Pull the seatback folding lever to unlock the seatback. The seatback will be folded down.

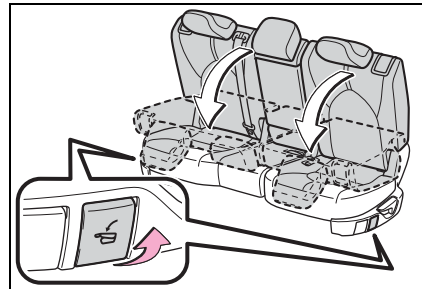

■ **After folding down the second seats**

Slide the folded second seats backward until they lock.

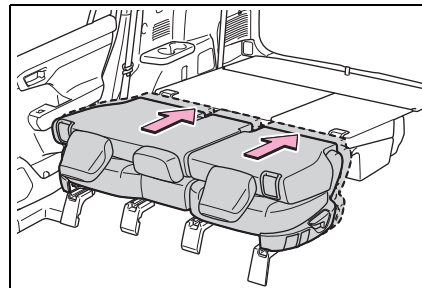

■ **Returning the second seats**

Lift up the seatbacks until they lock.

Remove the secured seat belts from the seat belt hangers before using them.

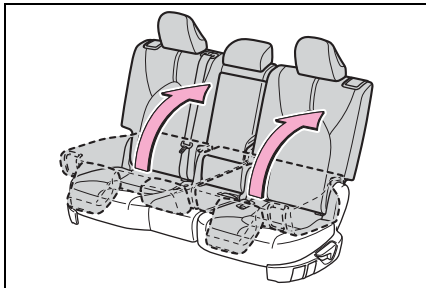

■ **Folding down the third seats**

■ **Before folding down the third seats**

- 1 Stow the third seat belt buckles.

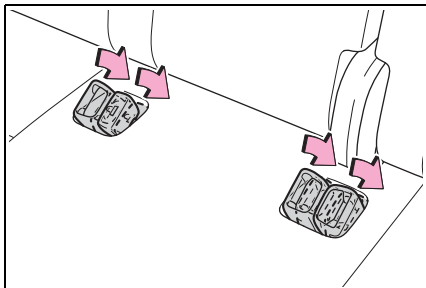

- 2 Pass the outer seat belts through the seat belt hangers and secure the seat belt plates.

This prevents the shoulder belts

from being damaged.

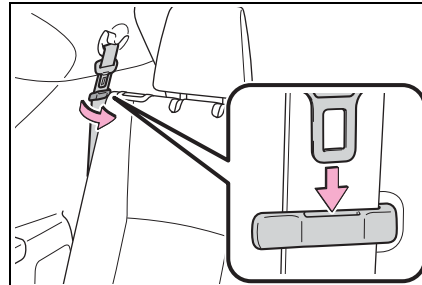

- 3 Lower the center head restraint to the lowest position. (→P.147)

■ **Folding down the third seats**

While pulling the the seatback angle adjustment lever, fold down the seatbacks.

The outer head restraints will fold forward.

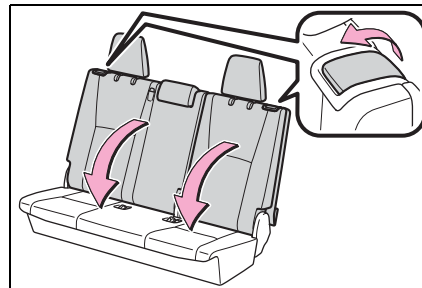

■ **Returning the third seats**

- 1 Returning the seatbacks

▶ From inside

Lift up the seatbacks until they lock.

3

Before driving

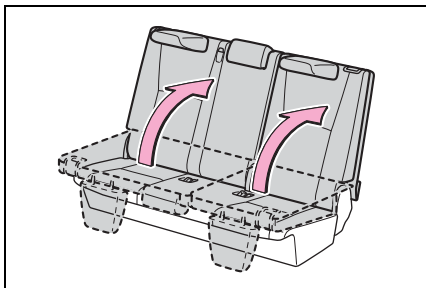

► From outside

Pull the straps and raise the seatbacks until they lock.

After using either strap, use the velcro on the strap to attach it to the seatback.

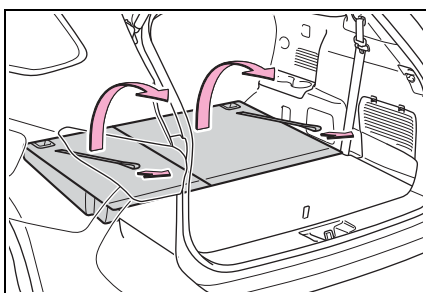

2 Returning the outer head restraints.

Remove the secured seat belts from the seat belt hangers before using them.

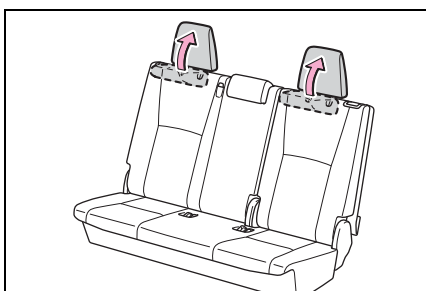

**Driving position memory\***

\*: If equipped

**This feature automatically adjusts the driver's seat, outside rear view mirrors and head-up display (if equipped) to suit your preferences.**

**Two different driving positions can be recorded into memory.**

**Each electronic key can be registered to recall your preferred driving position.**

**Recording a driving position into memory**

- 1 Check that the shift lever is in P.
- 2 Turn the engine switch to ON.
- 3 Adjust the driver's seat, outside rear view mirrors and head-up display (if equipped) to the desired positions.
- 4 While pressing the "SET" button, or within 3 seconds after the "SET" button is pressed, press button "1" or "2" until the buzzer sounds.

If the selected button has already been preset, the previously recorded position will be overwritten.



ten.

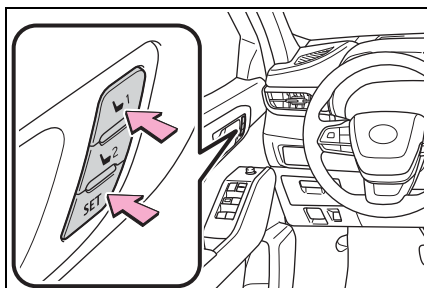

■ **Seat positions that can be memorized**

The adjusted positions other than the position adjusted by lumbar support switch can be recorded.

■ **In order to correctly use the driving position memory function**

If a seat position is already in the furthest possible position and the seat is operated in the same direction, the recorded position may be slightly different when it is recalled.

**⚠ WARNING**

■ **Seat adjustment caution**

Take care during seat adjustment so that the seat does not strike the rear passenger or squeeze your body against the steering wheel.

**Recalling a driving position**

- 1 Check that the shift lever is in P.
- 2 Turn the engine switch to ON.
- 3 Press one of the buttons for the driving position you want

to recall until the buzzer sounds.

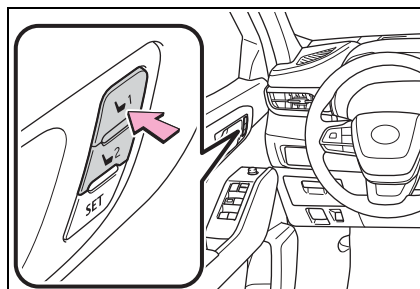

■ **To stop the position recall operation part-way through**

Perform any of the following operations:

- Press the "SET" button.
- Press button "1" or "2".
- Operate any of the seat adjustment switches (only cancels seat position recall).

■ **Operating the driving position memory after turning the engine switch off**

Recorded seat positions can be activated up to 180 seconds after the driver's door is opened and another 60 seconds after it is closed again.

**Registering/canceling/recall a driving position to an electronic key (memory recall function)**

■ **Registering procedure**

Record your driving position to button "1" or "2" before performing the following:

Carry only the key you want to register, and then close the driver's door.

3  
Before driving

If 2 or more keys are in the vehicle, the driving position cannot be recorded properly.

- 1 Check that the shift lever is in P.
- 2 Turn the engine switch to ON.
- 3 Recall the driving position that you want to record.
- 4 While pressing the recalled button, press and hold the door lock switch (either lock or unlock) until the buzzer sounds.

If the button could not be registered, the buzzer sounds continuously for approximately 3 seconds.

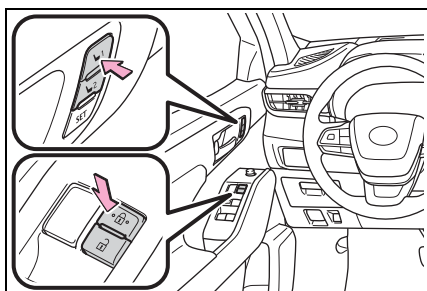

■ **Cancellation procedure**

Carry only the key you want to cancel and then close the driver's door.

If 2 or more keys are in the vehicle, the driving position cannot be canceled properly.

- 1 Turn the engine switch to ON.
- 2 While pressing the "SET" button, press and hold the door lock switch (either lock or

unlock) until the buzzer sounds twice.

If the button could not be canceled, the buzzer sounds continuously for approximately 3 seconds.

■ **Recall procedure**

Make sure that the doors are locked before recalling the driving position. Carry the electronic key that has been registered to the driving position, and then unlock and open the driver's door using the smart key system or wireless remote control.

The driving position will move to the recorded position.

If the driving position is in a position that has already been recorded, the seat and outside rear view mirrors will not move.

■ **Recalling the driving position using the memory recall function**

- Different driving positions can be registered for each electronic key. Therefore, the driving position that is recalled may be different depending on the key being carried.
- If a door other than the driver's door is unlocked with the smart key system, the driving position cannot be recalled. In this case, press the driving position button which has been set.

■ **Customization**

Some functions can be customized. (→P.515)

## Head restraints

Head restraints are provided for all seats.

### WARNING

#### Head restraint precautions

Observe the following precautions regarding the head restraints. Failure to do so may result in death or serious injury.

- Use the head restraints designed for each respective seat.
- Adjust the head restraints to the correct position at all times.
- After adjusting the head restraints, push down on them and make sure they are locked in position.
- Do not drive with the head restraints removed.

## Adjusting a head restraint

### Front seats

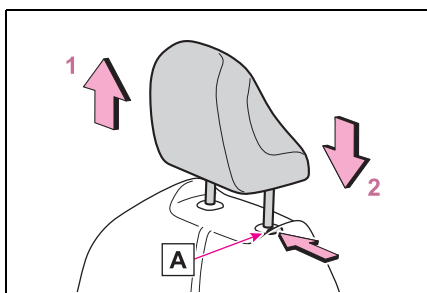

- 1 Up**  
Pull the head restraints up.
- 2 Down**  
Push the head restraint down while pressing the lock release button **A**.

### Second seats

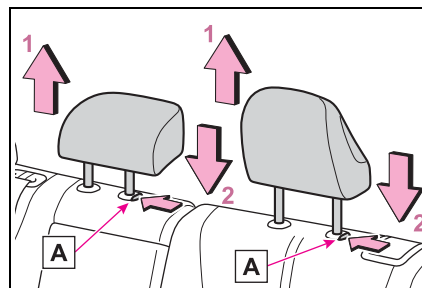

- 1 Up**  
Pull the head restraints up.
- 2 Down**  
Push the head restraint down while pressing the lock release button **A**.

### Third center seat

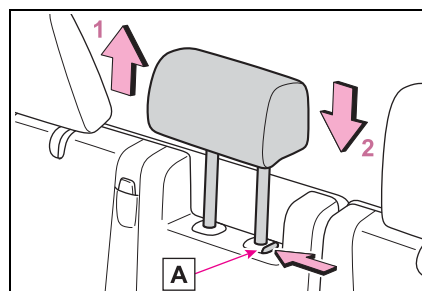

- 1 Up**  
Pull the head restraints up.
- 2 Down**  
Push the head restraint down while pressing the lock release button **A**.

### Adjusting the height of the head restraints

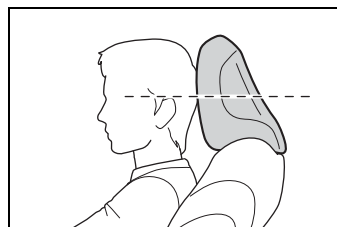

**3** Before driving

## 148 3-3. Adjusting the seats

Make sure that the head restraints are adjusted so that the center of the head restraint is closest to the top of your ears.

### ■ Adjusting the third center seat head restraint

Always raise the head restraint one level from the stowed position when using.

### ■ When using the outboard third seats

If a head restraint is folded forward, make sure to return it to the upright position. (→P.143)

### Removing the head restraints

Pull the head restraint up while pressing the lock release button

**A**.

If the head restraint touches the ceiling, making the removal difficult, change the seat height or angle. (→P.138, 139)

#### ► Front seats

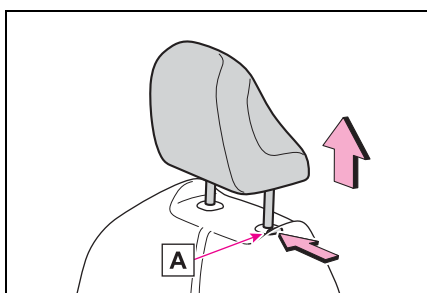

#### ► Second seats

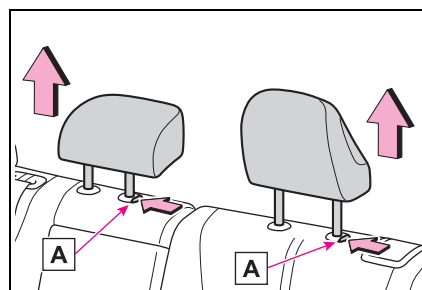

#### ► Third center seat

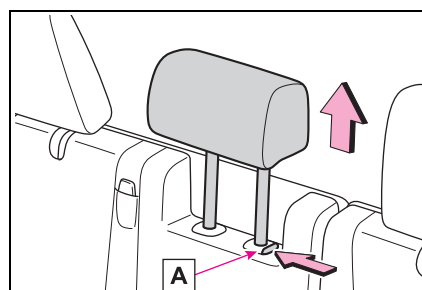

### Installing the head restraints

Align the head restraint with the installation holes and push it down to the lock position.

Press and hold the lock release button **A** when lowering the head restraint.

#### ► Front seats

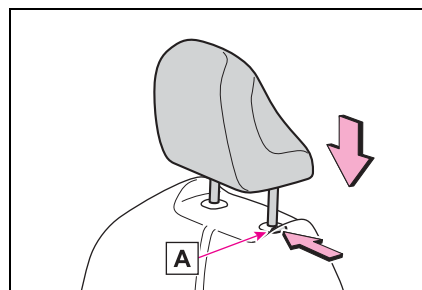

▶ Second seats

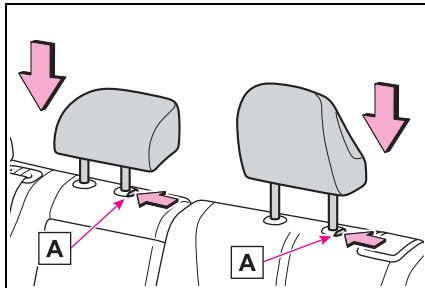

▶ Third center seat

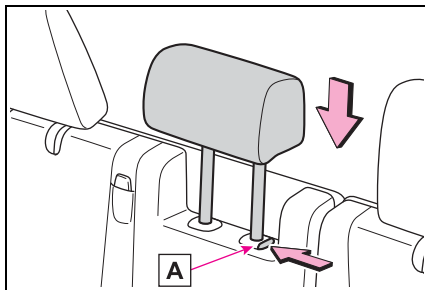

3

Before driving

### Steering wheel

#### Adjustment procedure

- 1 Hold the steering wheel and push the lever down.

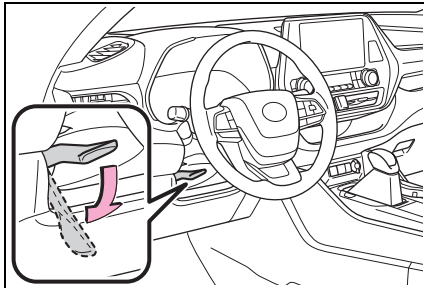

- 2 Adjust to the ideal position by moving the steering wheel horizontally and vertically.

After adjustment, pull the lever up to secure the steering wheel.

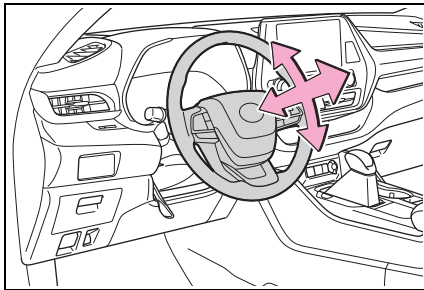

#### WARNING

##### ■ Caution while driving

Do not adjust the steering wheel while driving. Doing so may cause the driver to mishandle the vehicle and cause an accident, resulting in death or serious injury.

##### ■ After adjusting the steering wheel

Make sure that the steering wheel is securely locked. Otherwise, the steering wheel may move suddenly, possibly causing an accident, and resulting in death or serious injury. Also, the horn may not sound if the steering wheel is not securely locked.

### Sounding the horn

Press on or close to the  mark.

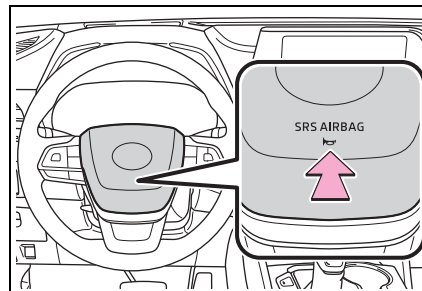

**Inside rear view mirror\***

\*: If equipped

**The rear view mirror's position can be adjusted to enable sufficient confirmation of the rear view.**

**Adjusting the height of rear view mirror**

The height of the rear view mirror can be adjusted to suit your driving posture.

Adjust the height of the rear view mirror by moving it up and down.

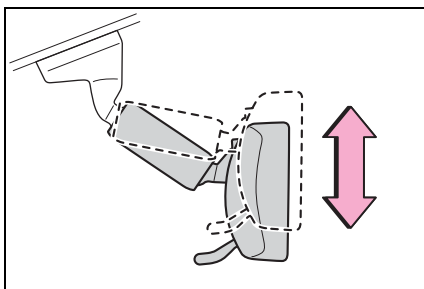

**⚠ WARNING**

**■ Caution while driving**

Do not adjust the position of the mirror while driving. Doing so may lead to mishandling of the vehicle and cause an accident, resulting in death or serious injury.

**Anti-glare function**

- ▶ Manual anti-glare inside rear view mirror

Reflected light from the headlights of vehicles behind can be reduced by operating the lever.

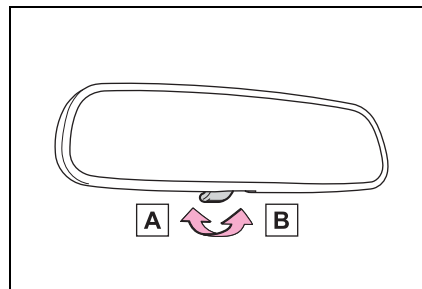

- A** Normal position
- B** Anti-glare position

- ▶ Auto anti-glare inside rear view mirror

Responding to the level of brightness of the headlights of vehicles behind, the reflected light is automatically reduced.

Turn the automatic anti-glare function mode on/off

When the automatic anti-glare function is in ON mode, the indicator **A** illuminates. The function will set to ON mode each time the engine switch is turned to ON.

Pressing the button turns the function to OFF mode. (The indicator **A** also turns off.)

3

Before driving

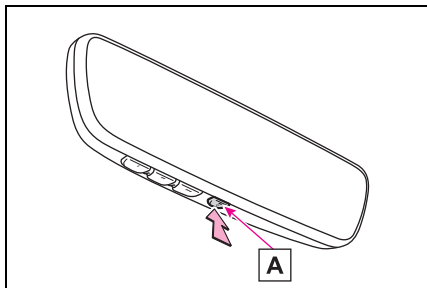

■ To prevent sensor error (vehicles with auto anti-glare inside rear view mirror)

To ensure that the sensors operate properly, do not touch or cover them.

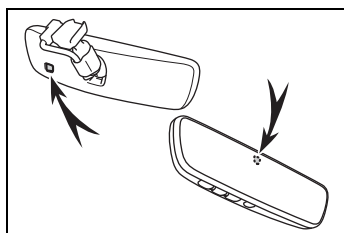

### Digital Rearview Mirror\*

\*: If equipped

The Digital Rearview Mirror is a system that uses the camera on the rear of the vehicle and displays its image on the display of the Digital Rearview Mirror.

The Digital Rearview Mirror can be changed between optical mirror mode and digital mirror mode by operating the lever.

The Digital Rearview Mirror allows the driver to see the rear view despite obstructions, such as the head restraints or luggage, ensuring rear visibility. Also, the rear seats are not displayed and privacy of the passengers is enhanced.

#### ⚠ WARNING

Observe the following precautions. Failure to do so may result in death or serious injury.

#### ■ Before using the Digital Rearview Mirror

- Make sure to adjust the mirror before driving. (→P.154)
- Change to optical mirror mode and adjust the position of the Digital Rearview Mirror so that the area behind your vehicle can be viewed properly.



**⚠ WARNING**

- Change to digital mirror mode and adjust the display settings.
- As the range of the image displayed by the Digital Rearview Mirror is different from that of the optical mirror, make sure to check this difference before driving.

**System components**

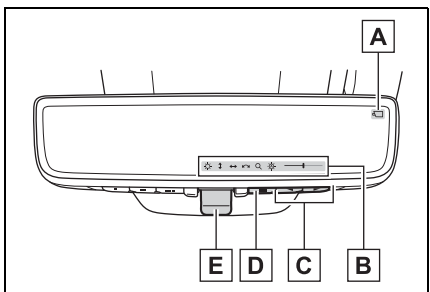

- A** Camera indicator  
Indicates that the camera is operating normally.
- B** Icon display area  
Displays icons, adjusting gauge, etc. (→P.154)
- C** Select button  
Press to change the setting of the item you want to adjust.
- D** Menu button  
Press to display the icon display area and select the item you want to adjust.
- E** Lever  
Operate to change between digital mirror mode and optical mirror mode.

**Changing modes**

Operate the lever to change between digital mirror mode and optical mirror mode.

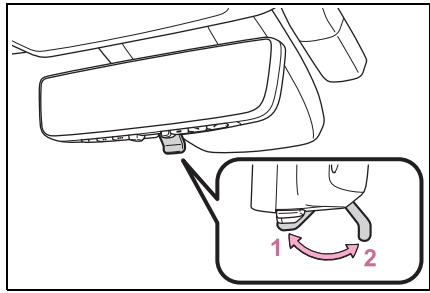

- 1** Digital mirror mode  
Displays an image of the area behind the vehicle.  
☑ will illuminate in this mode.
- 2** Optical mirror mode  
Turns off the display of the Digital Rearview Mirror allows it to be used as an optical mirror.

**Digital mirror mode operating condition**

The engine switch is turned to ON. When the engine switch is changed from ON to OFF or ACC, the image will disappear after several seconds.

**When using the Digital Rearview Mirror in digital mirror mode**

- If it is difficult to see the displayed image due to light reflected off the Digital Rearview Mirror, the camera being dirty, or if lights of a vehicle behind your vehicle or the displayed image are bothering you, change to optical mirror mode.
- When the back door is open, the Digital Rearview Mirror image may not display properly. Before driving, make sure the back door is

**3**

Before driving

closed.

- If the display is difficult to see due to reflected light, close the sunshade for the moon roof or the electronic sunshade for the panoramic moon roof.
- Any of the following conditions may occur when driving in the dark, such as at night. None of them indicates that a malfunction has occurred.
  - Colors of objects in the displayed image may differ from their actual color.
  - Depending on the height of the lights of the vehicle behind, the area around the vehicle may appear white and blurry.
  - Automatic image adjustment for brighter surrounding image may cause flickering.

If it is difficult to see the displayed image or flickering bothers you, change to optical mirror mode.

- The Digital Rearview Mirror may become hot while it is in digital mirror mode. This is not a malfunction.
- Depending on your physical condition or age, it may take longer than usual to focus on the displayed image. In this case, change to optical mirror mode.
- Do not let passengers stare at the displayed image when the vehicle is being driven, as doing so may cause motion sickness.

**■ When the system malfunctions**

If the symbol shown in the illustration is displayed when using the Digital Rearview Mirror in digital mirror mode, the system may be malfunctioning. The symbol will disappear in a few seconds. Operate the lever, change to optical mirror mode and have the vehicle inspected by your Toyota dealer.

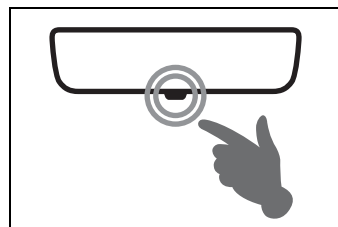

**Adjusting the mirror**

**■ Adjusting the mirror height**

The height of the rear view mirror can be adjusted to suit your driving posture.

Change to optical mirror mode, adjusting the height of the rear view mirror by moving it up and down.

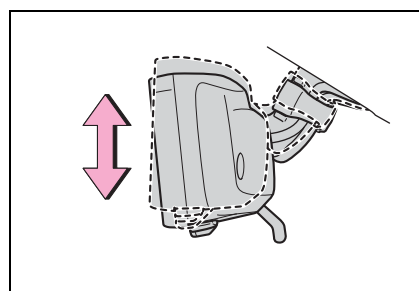

**■ Display settings (digital mirror mode)**

Settings of the display in the digital mirror mode, on/off operation of the automatic anti-glare function, etc. can be changed.

- 1 Press the menu button.

The icons will be displayed.

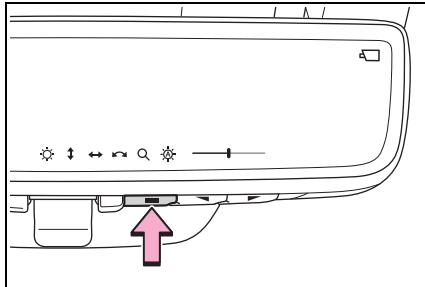

- 2 Press the menu button repeatedly and select the item you want to adjust.
- 3 Press or to change the setting.

The icons will disappear if a button is not operated for approximately 5 seconds or more.

Icons	Settings
	Select to adjust the brightness of the display.
	Select to adjust the area displayed up/down.
	Select to adjust the area displayed to the left/right.
	Select to adjust the angle of the displayed image.

Icons	Settings
	Select to zoom in/out the displayed image.
	Select to enable/disable the automatic anti-glare function.*  Responding to the brightness of the headlights of vehicles behind, the reflected light is automatically adjusted.  The automatic anti-glare function is enabled each time the engine switch is changed to ON.

\*: This is a function for the optical mirror mode, however, the setting can also be changed while using the digital mirror mode.

■ **Enabling/disabling the automatic anti-glare function (optical mirror mode)**

The automatic anti-glare function in the optical mirror mode can be enabled/disabled. The setting can be changed in both the digital mirror mode and the optical mirror mode.

- ▶ When using the digital mirror mode  
→P.154
- ▶ When using the optical mirror mode
  - 1 Press the menu button.



The icons will be displayed.

- 2 Press the menu button repeatedly and select .

3 Before driving

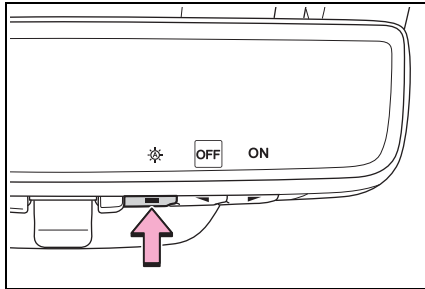
The setting display will be displayed.



- 3 Press  or  to enable (“ON”)/disable (“OFF”) the automatic anti-glare function.

The icons will disappear if a button is not operated for approximately 5 seconds or more.

■ **Adjusting the display (digital mirror mode)**

- If the displayed image is adjusted, it may appear distorted. This is not a malfunction.
- If the brightness of the Digital Rearview Mirror is set too high, it may cause eye strain. Adjust the Digital Rearview Mirror to an appropriate brightness. If your eyes become tired, change to optical mirror mode.
- The brightness of the Digital Rearview Mirror will change automatically according to the brightness of the area in front of your vehicle.

■ **To prevent the light sensors from malfunctioning**

To prevent the light sensors from malfunctioning, do not touch or cover them.

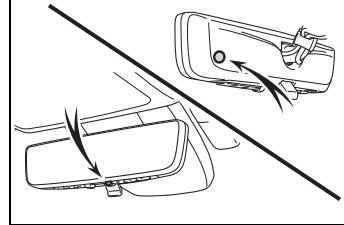

**! WARNING**

Observe the following precautions. Failure to do so may result in death or serious injury.

■ **While driving**

- Do not adjust the position of the Digital Rearview Mirror or adjust the display settings while driving. Stop the vehicle and operate the Digital Rearview Mirror control switches. Failure to do so may cause a steering wheel operation error, resulting in an unexpected accident.
- Always pay attention to the vehicle’s surroundings.

The size of the vehicles and other objects may look different when in digital mirror mode and optical mirror mode.

When backing up, make sure to directly check the safety of the area around your vehicle, especially behind the vehicle. Additionally, if a vehicle approaches from the rear in the dark, such as at night, the surrounding area may appear dim.

■ **To prevent causes of fire**

If the driver continues using the Digital Rearview Mirror while smoke or odor comes from the mirror, it may result in fire. Stop using the system immediately and contact your Toyota dealer.

**Cleaning the Digital Rear-view Mirror**

■ **Cleaning the mirror surface**

If the mirror surface is dirty, the image on the display may be difficult to see.

Clean the mirror surface gently using a soft dry cloth.

■ **Cleaning the camera**

If the camera lens is dirty or covered with foreign matter, such as water droplets, snow, mud, etc., the displayed image may not be clear. In this case, rinse the camera lens with a large quantity of water and then wipe it clean with a soft cloth dampened with water.

Dirt on the camera lens can be cleaned by operating the dedicated camera cleaning washer. (→P.223)

■ **The camera**

The camera for the Digital Rearview Mirror is located as shown.

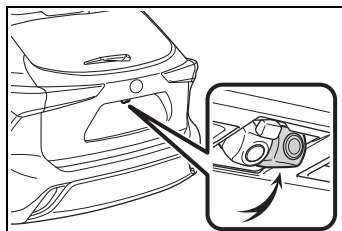

NOTICE

■ **To prevent the Digital Rear-view Mirror from malfunctioning**

● Do not use detergents, such as thinner, benzene, and alcohol to clean the mirror. They may discolor, deteriorate or damage the mirror surface.

● Do not smoke, use matches, use cigarette lighters or allow open flames near the mirror. It may damage the mirror or cause a fire.

● Do not remove, disassemble or modify the mirror.

■ **To prevent the camera from malfunctioning**

● Observe the following precautions, otherwise the Digital Rearview Mirror may not operate properly.

• Do not strike or hit the camera or subject it to a strong impact, as the camera installation position and angle may be changed.

• Do not remove, disassemble or modify the camera.

• When washing the camera, rinse it with a large quantity of water and then wipe it clean with a soft cloth dampened with water.

Do not strongly rub the camera lens, as it may be scratched and will not be able to transmit a clear image.

• Do not allow organic solvent, car wax, window cleaner or glass coat to adhere to the camera cover. If this happens, wipe it off as soon as possible.



**NOTICE**

- Do not apply hot water to the camera in cold weather, as the sudden change of temperature may cause the camera to not operate properly.
- When using a high pressure washer to wash the vehicle, do not directly spray the camera and its surrounding area, as doing so may cause the camera to not operate properly.
- Do not subject the camera to a strong impact as this could cause a malfunction.  
If this happens, have the vehicle inspected by your Toyota dealer as soon as possible.



**If you notice any symptoms**

If you notice any of the following symptoms, refer to the following table for the likely cause and the solution.



If the symptom is not resolved by the solution, have the vehicle inspected by your Toyota dealer.

Symptom	Likely cause	Solution
The image is difficult to see.	The mirror surface is dirty.	Clean the mirror surface gently, using a soft dry cloth.
	Sunlight or headlights are shining directly into the Digital Rearview Mirror.	Change to optical mirror mode. (If the light is coming through the moon roof or panoramic moon roof, close the sunshade or electronic sunshade.)
	<ul style="list-style-type: none"> <li>• The vehicle is in a dark area.</li> <li>• The vehicle is near a TV tower, broadcasting station, electric power plant, or other location where strong radio waves or electrical noise may be present.</li> <li>• The temperature around the camera is extremely high/low.</li> <li>• The ambient temperature is extremely low.</li> <li>• It is raining or humid.</li> <li>• Sunlight or headlights are shining directly into the camera lens.</li> <li>• The vehicle is under fluorescent lights, sodium lights, mercury lights, etc.</li> <li>• Exhaust gas is obstructing the camera.</li> </ul>	Change to optical mirror mode. (Change back to digital mirror mode when the conditions have improved.)

**160** 3-4. Adjusting the steering wheel and mirrors

Symptom	Likely cause	Solution
The image is difficult to see.	Foreign matters (such as water droplets, snow, mud, etc.) is on the camera lens.	<ul style="list-style-type: none"> <li>• Operate the dedicated camera cleaning washer and clean the camera lens. (→P.223)</li> <li>• Change to optical mirror mode.</li> <li>• Rinse the camera with a large quantity of water, wipe it clean with a soft cloth dampened with water, and then change back to digital mirror mode.</li> </ul>
The image is out of alignment.	The back door is not fully closed.	Fully close the back door.
	The camera or its surrounding area has received a strong impact.	Change to optical mirror mode and have the vehicle inspected by your Toyota dealer.
The display is dim and  is displayed.	The system may be malfunctioning.	Change to optical mirror mode and have the vehicle inspected by your Toyota dealer.
 goes off.		



Symptom	Likely cause	Solution
 is displayed.	The Digital Rearview Mirror is extremely hot. (The display will gradually become more dim. If the temperature continues to increase, the Digital Rearview Mirror will turn off.)	Reducing the cabin temperature is recommended to reduce the temperature of the mirror. (  will disappear when the mirror becomes cool.)  If  does not disappear even though the mirror is cool, have the vehicle inspected by your Toyota dealer.
The lever cannot be operated properly.	The lever may be malfunctioning.	Change to optical mirror mode and have the vehicle inspected by your Toyota dealer. (To change to optical mirror mode, press and hold the menu button for approximately 10 seconds.)

**Outside rear view mirrors**

The rear view mirror's position can be adjusted to enable sufficient confirmation of the rear view.

**⚠ WARNING**

**■ Important points while driving**

Observe the following precautions while driving. Failing to do so may result in loss of control of the vehicle and cause an accident, resulting in death or serious injury.

- Do not adjust the mirrors while driving.
- Do not drive with the mirrors folded.
- Both the driver and passenger side mirrors must be extended and properly adjusted before driving.

**Adjustment procedure**

- 1 To select a mirror to adjust, turn the switch.

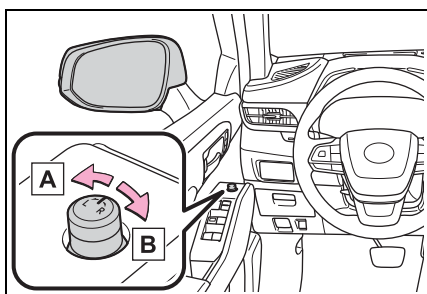

- A Left
- B Right

- 2 To adjust the mirror, operate the switch.

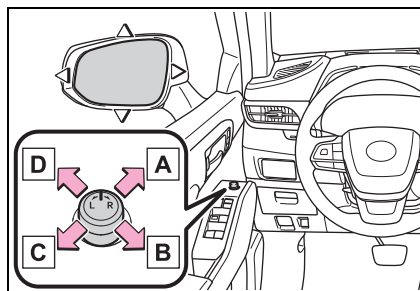

- A Up
- B Right
- C Down
- D Left

**■ Mirror angle can be adjusted when**

The engine switch is in ACC or ON.

**■ When the mirrors are fogged up**

The outside rear view mirrors can be cleared using the mirror defoggers. Turn on the rear window defogger to turn on the outside rear view mirror defoggers. (→P.329, 335)

**■ Automatic adjustment of the mirror angle (if equipped)**

A desired mirror face angle can be entered to memory and recalled automatically by the driving position memory. (→P.144)

**■ Linked mirror function when reversing (if equipped)**

When either "L" or "R" of the mirror select switch is selected, the outside rear view mirrors will automatically angle downwards when the vehicle is reversing in order to give a better view of the ground.

To disable this function, select neither "L" nor "R".

To set the mirror angle used when

the vehicle is reversing, adjust the mirror angle at a desired position with the shift lever in R.

The adjusted angle will be memorized and the mirror will automatically tilt to the memorized angle whenever the shift lever is shifted to R from next time.

The memorized downward tilt position of the mirror is linked to the normal position (angle adjusted with the shift lever in other than R). Therefore, if the normal position is changed after adjustment, the tilt position will also change.

When the normal position is changed, readjust the angle in reversing.

**⚠ WARNING**

■ **When the mirror defoggers are operating**

Do not touch the rear view mirror surfaces, as they can become very hot and burn you.

**Folding the mirrors**

Push the mirror back in the direction of the vehicle's rear.

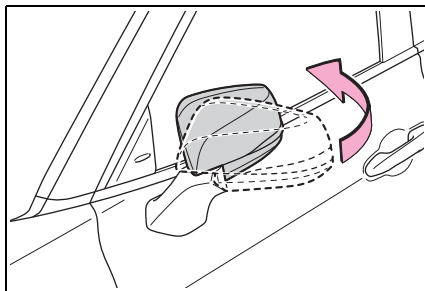

## Power windows

### Opening and closing the power windows

The power windows can be opened and closed using the switches.

Operating the switch moves the windows as follows:

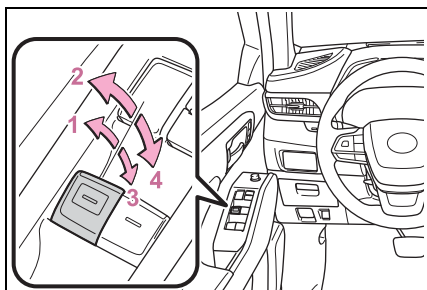

- 1 Closing
- 2 One-touch closing\*
- 3 Opening
- 4 One-touch opening\*

\*: To stop the window partway, operate the switch in the opposite direction.

#### ■ The power windows can be operated when

The engine switch is in ON.

#### ■ Operating the power windows after turning the engine off

The power windows can be operated for approximately 45 seconds even after the engine switch is turned to ACC or turned off. They cannot, however, be operated once either front door is opened.

#### ■ Jam protection function

If an object becomes jammed between the window and the win-

dow frame while the window is closing, window movement is stopped and the window is opened slightly.

#### ■ Catch protection function

If an object becomes caught between the door and window while the window is opening, window movement is stopped.

#### ■ When the window cannot be opened or closed

When the jam protection function or catch protection function operates unusually and the door window cannot be opened or closed, perform the following operations with the power window switch of that door.

- Stop the vehicle. With the engine switch in ON, within 4 seconds of the jam protection function or catch protection function activating, continuously operate the power window switch in the one-touch closing direction or one-touch opening direction so that the door window can be opened and closed.
- If the door window cannot be opened and closed even when performing the above operations, perform the following procedure for function initialization.

- 1 Turn the engine switch to ON.
- 2 Pull and hold the power window switch in the one-touch closing direction and completely close the door window.
- 3 Release the power window switch for a moment, resume pulling the switch in the one-touch closing direction, and hold it there for approximately 6 seconds or more.
- 4 Press and hold the power window switch in the one-touch opening direction. After the door window is completely opened, continue holding the switch for an additional 1 second or more.
- 5 Release the power window switch for a moment, resume

pushing the switch in the one-touch opening direction, and hold it there for approximately 4 seconds or more.

- 6 Pull and hold the power window switch in the one-touch closing direction again. After the door window is completely closed, continue holding the switch for a further 1 second or more.

If you release the switch while the window is moving, start again from the beginning.

If the window reverses and cannot be fully closed or opened, have the vehicle inspected by your Toyota dealer.

**■ Door lock linked window operation**

- The power windows can be opened and closed using the mechanical key.\* (→P.481)
- The power windows can be opened using the wireless remote control.\* (→P.115)

\*: These settings must be customized at your Toyota dealer.

**■ Power windows open warning buzzer**

A buzzer sounds and a message is shown on the multi-information display when the engine switch is turned off and the driver's door is opened with the power windows open.

**■ Customization**

Some functions can be customized. (→P.515)

**⚠ WARNING**

Observe the following precautions. Failing to do so may result in death or serious injury.

**■ Closing the windows**

- The driver is responsible for all the power window operations, including the operation for the passengers. In order to prevent accidental operation, especially by a child, do not let a child operate the power windows. It is possible for children and other passengers to have body parts caught in the power window. Also, when riding with a child, it is recommended to use the window lock switch. (→P.166)
- Check to make sure that all passengers do not have any part of their body in a position where it could be caught when a window is being operated.

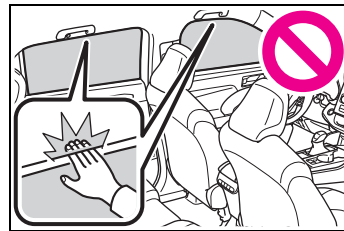

- When using the wireless remote control or mechanical key and operating the power windows, operate the power window after checking to make sure that there is no possibility of any passenger having any of their body parts caught in the window. Also do not let a child operate window by the wireless remote control or mechanical key. It is possible for children and other passengers to get caught in the power window.
- When exiting the vehicle, turn the engine switch off, carry the key and exit the vehicle along with the child. There may be accidental operation, due to mischief, etc., that may possibly lead to an accident.

**⚠ WARNING**

■ **Jam protection function**

- Never use any part of your body to intentionally activate the jam protection function.
- The jam protection function may not work if something gets jammed just before the window is fully closed. Be careful not to get any part of your body jammed in the window.

■ **Catch protection function**

- Never use any part of your body or clothing to intentionally activate the catch protection function.
- The catch protection function may not work if something gets caught just before the window is fully opened. Be careful not to get any part of your body or clothing caught in the window.

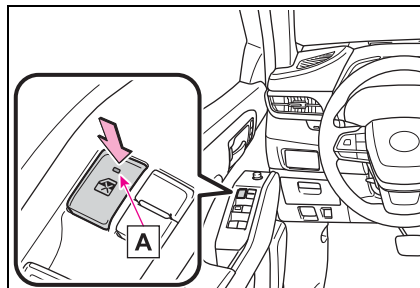

■ **The power windows can be operated when**

The engine switch is in ON.

■ **When the battery is disconnected**

The window lock switch is disabled. If necessary, press the window lock switch after reconnecting the battery.

**Preventing accidental operation (window lock switch)**

This function can be used to prevent children from accidentally opening or closing a passenger window.

Press the switch.

The indicator **A** will come on and the passenger windows will be locked.

The passenger windows can still be opened and closed using the driver's switch even if the lock switch is on.

**Moon roof\***

\*: If equipped

**Use the overhead switches to open and close the moon roof and tilt it up and down.**

**Operating the moon roof**

■ **Opening and closing**

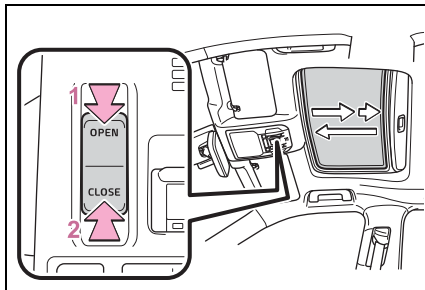

**1** Opens the moon roof\*

The moon roof stops slightly before the fully open position to reduce wind noise. Press the switch again to fully open the moon roof.

**2** Closes the moon roof\*

\*: Lightly press either side of the moon roof switch to stop the moon roof partway.

■ **Tilting up and down**

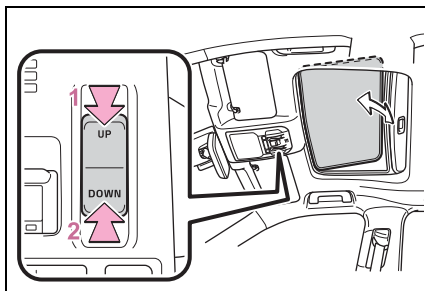

**1** Tilts the moon roof up\*

**2** Tilts the moon roof down\*

\*: Lightly press either side of the moon roof switch to stop the moon roof partway.

■ **The moon roof can be operated when**

The engine switch is in ON.

■ **Operating the moon roof after turning the engine off**

The moon roof can be operated for approximately 45 seconds after the engine switch is turned to ACC or turned off. It cannot, however, be operated once either front door is opened.

■ **Jam protection function**

If an object is detected between the moon roof and the frame while the moon roof is closing or tilting down, travel is stopped and the moon roof opens slightly.

■ **Sunshade**

The sunshade can be opened and closed manually. However, the sunshade will open automatically when the moon roof is opened.

■ **Door lock linked moon roof operation**

- The moon roof can be opened and closed using the mechanical key.\* (→P.481)
- The moon roof can be opened using the wireless remote control.\* (→P.115)

\*: These settings must be customized at your Toyota dealer.

■ **When the moon roof does not close normally**

Perform the following procedure:

- If the moon roof closes but then re-opens slightly

**1** Stop the vehicle.

- 2** Press and hold the “CLOSE” switch.\*<sup>1</sup>

The moon roof will close, reopen and pause for approximately 10 seconds.\*<sup>2</sup> Then it will close again, tilt up and pause for approximately 1 second. Finally, it will tilt down, open and close.

- 3** Check to make sure that the moon roof is completely closed and then release the switch.

- If the moon roof tilts down but then tilts back up

- 1** Stop the vehicle.
- 2** Press and hold the “UP” switch\*<sup>1</sup> until the moon roof moves into the tilt up position and stops.
- 3** Release the “UP” switch once and then press and hold the “UP” switch again.\*<sup>1</sup>

The moon roof will pause for approximately 10 seconds in the tilt up position.\*<sup>2</sup> Then it will adjust slightly and pause for approximately 1 second. Finally, it will tilt down, open and close.

- 4** Check to make sure that the moon roof is completely closed and then release the switch.

\*<sup>1</sup>: If the switch is released at the incorrect time, the procedure will have to be performed again from the beginning.

\*<sup>2</sup>: If the switch is released after the above mentioned 10 second pause, automatic operation will be disabled. In that case, press and hold the “CLOSE” or “UP” switch, and the moon roof will tilt up and pause for approximately 1 second. Then it will tilt down, open and close. Check to make sure that the moon roof is completely closed and then release the switch.

If the moon roof does not fully close

even after performing the above procedure correctly, have the vehicle inspected by your Toyota dealer.

■ **Moon roof open warning buzzer**

A buzzer sounds and a message is shown on the multi-information display when the engine switch is turned off and the driver’s door is opened with the moon roof open.

■ **Customization**

Some functions can be customized. (→P.515)

 **WARNING**

Observe the following precautions. Failing to do so may cause death or serious injury.

- **Opening the moon roof**
  - Do not allow any passengers to put their hands or heads outside the vehicle while it is moving.
  - Do not sit on top of the moon roof.
- **Opening and closing the moon roof**
  - The driver is responsible for moon roof opening and closing operations. In order to prevent accidental operation, especially by a child, do not let a child operate the moon roof. It is possible for children and other passengers to have body parts caught in the moon roof.



**⚠ WARNING**

- Check to make sure that all passengers do not have any part of their body in a position where it could be caught when the moon roof is being operated.

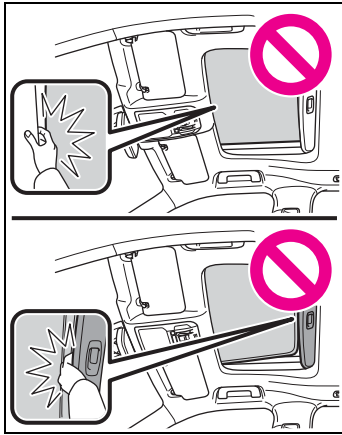

- When using the wireless remote control or mechanical key and operating the moon roof, operate the moon roof after checking to make sure that there is no possibility of any passenger having any of their body parts caught in the moon roof. Also, do not let a child operate moon roof by the wireless remote control or mechanical key. It is possible for children and other passengers to get caught in the moon roof.
- When exiting the vehicle, turn the engine switch off, carry the key and exit the vehicle along with the child. There may be accidental operation, due to mischief, etc., that may possibly lead to an accident.

■ **Jam protection function**

- Never use any part of your body to intentionally activate the jam protection function.

- The jam protection function may not work if something gets caught just before the moon roof is fully closed. Also, the jam protection function is not designed to operate while the switch is being pressed. Take care so that your fingers, etc. do not get caught.

**Panoramic moon roof\***

\*: If equipped

**Use the overhead switches to operate the panoramic moon roof and electronic sunshade.**

**Operating the panoramic moon roof**

■ **Opening and closing the electronic sunshade**

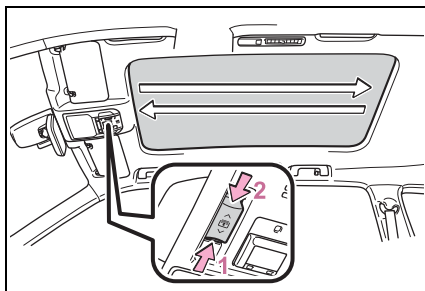

- 1 Opens the electronic sunshade\*
- 2 Closes the electronic sunshade\*

\*: Lightly press either side of the sunshade switch to stop the electronic sunshade partway.

■ **Tilting the panoramic moon roof up and down**

Tilt up (press)\*

If the panoramic moon roof is open, pressing the switch closes it up to the tilt-up position.

If the shade is closed past the half-open position when the switch is pressed, it will open up to the

half-open position.

To stop operation partway, quickly slide and release the switch again.

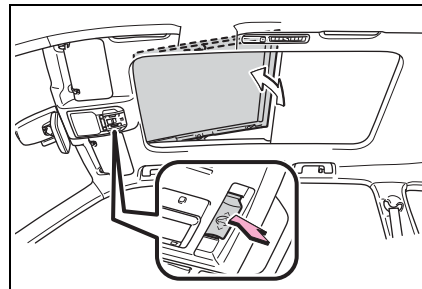

Tilt down (press and hold)

The panoramic moon roof can be tilted down only when it is in the tilt-up position.

■ **Opening and closing the panoramic moon roof**

Open (slide backward)\*

To stop operation partway, quickly slide and release the switch again.

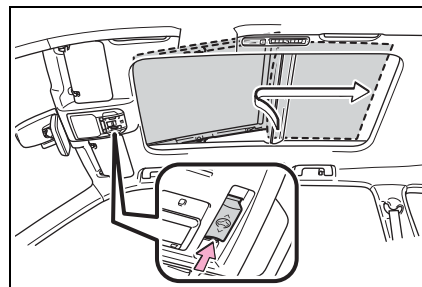

Close (slide forward)\*

The panoramic moon roof stops at the tilt-up position.

Slide and hold the switch again to fully close the panoramic moon roof.

To stop operation partway, quickly slide and release the switch again.

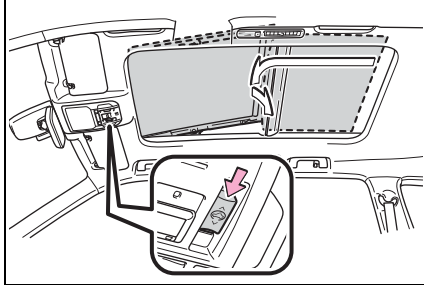

■ **The panoramic moon roof can be operated when**

The engine switch is in ON.

■ **Operating the panoramic moon roof after turning the engine off**

The panoramic moon roof and electronic sunshade can be operated for approximately 45 seconds after the engine switch is turned to ACC or turned off. It cannot, however, be operated once either front door is opened.

■ **Closing the shade when the panoramic moon roof is open**

- 1 Slide the shade switch forward.

The shade closes up to its half-closed position and then the panoramic moon roof closes up to the tilt-up position.

- 2 Slide and hold the shade switch again.

The panoramic moon roof closes as long as the switch is being held. After the panoramic moon roof is fully closed, the shade will fully close automatically.

■ **Jam protection function**

If an object is detected between the panoramic moon roof and the frame in the following situations, travel is stopped and the panoramic moon roof opens slightly:

- The panoramic moon roof is closing or tilting down.
- The electronic sunshade is closing.

■ **When the panoramic moon roof does not close normally**

Perform the following procedure:

- If the panoramic moon roof closes but then re-opens slightly

- 1 Stop the vehicle.
- 2 Slide the panoramic moon roof switch forward and hold it.\*

The panoramic moon roof will close then reopen and pause for approximately 10 seconds. Then it will close up to the tilt-up position.

- 3 Release the switch and then slide it forward and hold it again.

The panoramic moon roof will close as long as the switch is being held.

- 4 Check to make sure that the panoramic moon roof is completely closed and then release the switch.

- If the panoramic moon roof tilts down but then tilts back up

- 1 Stop the vehicle.
- 2 Slide the panoramic moon roof switch forward and hold it.\*

The panoramic moon roof will tilt down then tilt up and pause for approximately 10 seconds. Then it will close.

- 3 Check to make sure that the panoramic moon roof is completely closed and then release the switch.

\*: If the switch is released at the incorrect time, the procedure will have to be performed again from the beginning.

If the panoramic moon roof does not fully close even after performing the above procedure correctly, have the vehicle inspected by your Toyota dealer.

■ **When the shade does not close normally**

Perform the following procedure:

- 1 Stop the vehicle.
- 2 Close the panoramic moon roof.

- 3 Slide the shade switch forward and hold it.\*

The shade will close then reopen and pause for approximately 10 seconds. Then it will close.

- 4 Check to make sure that the shade is completely closed and then release the switch.

\*: If the switch is released at the incorrect time, the procedure will have to be performed again from the beginning.

If the shade continues to close but then reopens slightly even after performing the above procedure correctly, have the vehicle inspected by your Toyota dealer.

**■ Panoramic moon roof open warning buzzer**

A buzzer sounds and a message is shown on the multi-information display when the engine switch is turned off and the driver's door is opened with the panoramic moon roof open.

**⚠ WARNING**

Observe the following precautions. Failing to do so may cause death or serious injury.

**■ Opening and closing the electronic sunshade**

- Check to make sure that all passengers do not have any part of their body in a position where it could be caught when the electronic sunshade is being operated.

- Do not let a child operate the electronic sunshade. Closing the electronic sunshade on someone can cause death or serious injury.

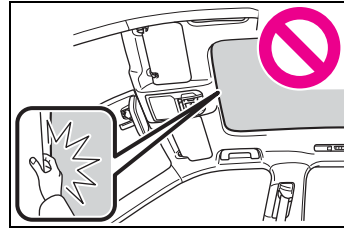

**■ Opening the panoramic moon roof**

- Do not allow any passengers to put their hands or heads outside the vehicle while it is moving.

- Do not sit on top of the panoramic moon roof.

**■ Opening and closing the panoramic moon roof**

- The driver is responsible for panoramic moon roof opening and closing operations. In order to prevent accidental operation, especially by a child, do not let a child operate the panoramic moon roof. It is possible for children and other passengers to have body parts caught in the panoramic moon roof.

**⚠ WARNING**

- Check to make sure that all passengers do not have any part of their body in a position where it could be caught when the panoramic moon roof is being operated.

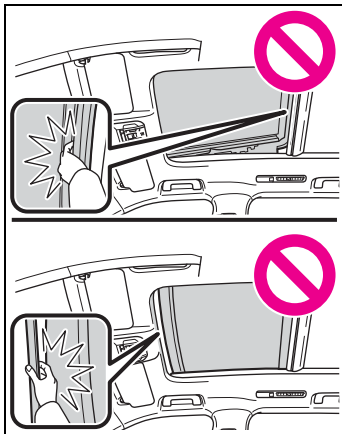

- When exiting the vehicle, turn the engine switch off, carry the key and exit the vehicle along with the child. There may be accidental operation, due to mischief, etc., that may possibly lead to an accident.

**■ Jam protection function**

- Never use any part of your body to intentionally activate the jam protection function.
- The jam protection function may not work if something gets caught just before the panoramic moon roof or electronic sunshade is fully closed. Also, the jam protection function is not designed to operate while the switch is being pressed. Take care so that your fingers, etc. do not get caught.

**■ To prevent burns or injuries**

Do not touch the area between the underside of the panoramic moon roof and the electronic sunshade. Your hand may get caught and you could injure yourself. Also, if the vehicle is left in direct sunlight for a long time, the underside of the panoramic moon roof could become very hot and could cause burns.

**⚠ NOTICE**

**■ To prevent damage to the panoramic moon roof**

- Before opening the panoramic moon roof, make sure that there are no foreign objects, such as stones or ice, around the opening.
- Do not hit the surface or edge of the panoramic moon roof with hard objects.
- **After the vehicle has been washed or rained on**

Before opening the panoramic moon roof, wipe any water off the panoramic moon roof. Otherwise, water may enter the cabin when the panoramic moon roof is opened.



- 4-1. Before driving**
- Driving the vehicle..... **177**
  - Cargo and luggage ..... **184**
  - Vehicle load limits ..... **187**
  - Trailer towing..... **188**
  - Dinghy towing ..... **199**
- 4-2. Driving procedures**
- Engine (ignition) switch  
..... **200**
  - Automatic transmission  
..... **204**
  - Turn signal lever..... **208**
  - Parking brake..... **209**
  - Brake Hold ..... **212**
- 4-3. Operating the lights and wipers**
- Headlight switch..... **214**
  - Automatic High Beam . **217**
  - Fog light switch ..... **220**
  - Windshield wipers and washer..... **220**
  - Rear windshield wiper and washer..... **223**
- 4-4. Refueling**
- Opening the fuel tank cap  
..... **225**
- 4-5. Using the driving support systems**
- Toyota Safety Sense 2.0  
..... **227**
  - PCS (Pre-Collision System)  
..... **233**
  - LTA (Lane Tracing Assist)  
..... **241**
  - RSA (Road Sign Assist)  
..... **251**
  - Dynamic radar cruise control with full-speed range  
..... **254**
  - Stop & Start system .... **264**
  - BSM (Blind Spot Monitor)  
..... **270**
  - Intuitive parking assist . **276**
  - RCTA (Rear cross traffic alert) function..... **284**
  - PKSB (Parking Support Brake)..... **289**
  - Parking Support Brake function (static objects) .... **296**
  - Parking Support Brake function (rear-crossing vehicles)..... **302**
  - Driving mode select switch  
..... **306**
  - Multi-terrain Select ..... **307**
  - Snow mode switch ..... **310**
  - Downhill assist control system ..... **311**
  - Driving assist systems  
..... **313**
- 4-6. Driving tips**
- Winter driving tips..... **319**

**176**

**Driving**

**4**

---

Utility vehicle precautions  
..... **322**



## Driving the vehicle

The following procedures should be observed to ensure safe driving:

### Driving procedure

#### ■ Starting the engine

→P.200

#### ■ Driving

- 1 With the brake pedal depressed, shift the shift lever to D. (→P.204)
- 2 Release the parking brake. (→P.209)

If the parking brake is in automatic mode, the parking brake is released automatically when shifting the shift lever to any position other than P. (→P.209)

- 3 Gradually release the brake pedal and gently depress the accelerator pedal to accelerate the vehicle.

#### ■ Stopping

- 1 With the shift lever in D, depress the brake pedal.

Vehicles with a Stop & Start system:  
If the Stop & Start system is enabled, depressing the brake pedal will stop the engine.

- 2 If necessary, set the parking brake. (→P.209)

If the vehicle is to be stopped for an extended period of time, shift the shift lever to P or N. (→P.204)

#### ■ Parking the vehicle

- 1 With the shift lever in D, depress the brake pedal.
- 2 Set the parking brake (→P.209), and shift the shift lever to P (→P.204).
- 3 Press the engine switch to stop the engine.
- 4 Lock the door, making sure that you have the electronic key on your person.

If parking on a hill, block the wheels as needed.

#### ■ Starting off on a steep uphill

- 1 With the brake pedal depressed, shift the shift lever to D. (→P.205)
- 2 Pull the parking brake switch and parking brake is set manually. (→P.209)
- 3 Release the brake pedal and gently depress the accelerator pedal to accelerate the vehicle.
- 4 Push the parking brake switch and parking brake is released manually.

#### ■ When starting off on a uphill

The hill-start assist control will activate. (→P.313)

#### ■ Driving in the rain

- Drive carefully when it is raining, because visibility will be reduced, the windows may become fogged-up, and the road will be slippery.
- Drive carefully when it starts to

rain, because the road surface will be especially slippery.

- Refrain from high speeds when driving on an expressway in the rain, because there may be a layer of water between the tires and the road surface, preventing the steering and brakes from operating properly.

■ **Engine speed while driving**

In the following conditions, the engine speed may become high while driving. This is due to automatic up-shifting control or down-shifting implementation to meet driving conditions. It does not indicate sudden acceleration.

- The vehicle is judged to be driving uphill or downhill
- When the accelerator pedal is released
- When the brake pedal is depressed while sport mode is selected

■ **Restraining the engine output (Brake Override System)**

- When the accelerator and brake pedals are depressed at the same time, the engine output may be restrained.
- A warning message is displayed on the multi-information display and head-up display (if equipped) while the system is operating.

■ **Restraining sudden start (Drive-Start Control)**

- When the following unusual operation is performed, the engine output may be restrained.
- When the shift lever is shifted from R to D, D to R, N to R, P to D, or P to R (D includes M) with the accelerator pedal depressed, a warning message appears on the multi-information display and head-up display (if equipped). If a warning message is shown on the multi-information display and head-up display (if equipped),

read the message and follow the instructions.

- When the accelerator pedal is depressed too much while the vehicle is in reverse.
- While Drive-Start Control is being activated, your vehicle may have trouble escaping from the mud or fresh snow. In such case, deactivate TRAC (→P.314) to cancel Drive-Start Control so that the vehicle may become able to escape from the mud or fresh snow.
- AWD models: Drive-Start Control does not work when Mud & Sand or Rock & Dirt mode is selected for Multi-terrain Select.

■ **Breaking in your new Toyota**

To extend the life of the vehicle, observing the following precautions is recommended:

- For the first 200 miles (300 km):  
Avoid sudden stops.
- For the first 500 miles (800 km):  
Do not tow a trailer.
- For the first 600 miles (1000 km):
  - Do not drive at extremely high speeds.
  - Avoid sudden acceleration.
  - Do not drive continuously in low gears.
  - Do not drive at a constant speed for extended periods.

■ **Operating your vehicle in a foreign country**

Comply with the relevant vehicle registration laws and confirm the availability of the correct fuel. (→P.495)

■ **Eco-friendly driving**

→P.84, 93

**⚠ WARNING**

Observe the following precautions. Failure to do so may result in death or serious injury.

**■ When starting the vehicle**

Always keep your foot on the brake pedal while stopped with the engine running. This prevents the vehicle from creeping.

**■ When driving the vehicle**

- Do not drive if you are unfamiliar with the location of the brake and accelerator pedals to avoid depressing the wrong pedal.
- Accidentally depressing the accelerator pedal instead of the brake pedal will result in sudden acceleration that may lead to an accident.
- When backing up, you may twist your body around, leading to a difficulty in operating the pedals. Make sure to operate the pedals properly.
- Make sure to keep a correct driving posture even when moving the vehicle only slightly. This allows you to depress the brake and accelerator pedals properly.
- Depress the brake pedal using your right foot. Depressing the brake pedal using your left foot may delay response in an emergency, resulting in an accident.
- Do not drive the vehicle over or stop the vehicle near flammable materials. The exhaust system and exhaust gases can be extremely hot. These hot parts may cause a fire if there is any flammable material nearby.

- During normal driving, do not turn off the engine. Turning the engine off while driving will not cause loss of steering or braking control, but the power assist to these systems will be lost. This will make it more difficult to steer and brake, so you should pull over and stop the vehicle as soon as it is safe to do so. However, in the event of an emergency, such as if it becomes impossible to stop the vehicle in the normal way: →P.442
- Use engine braking (downshift) to maintain a safe speed when driving down a steep hill. Using the brakes continuously may cause the brakes to overheat and lose effectiveness. (→P.204)
- Do not adjust the positions of the steering wheel, the seat, or the inside or outside rear view mirrors while driving. Doing so may result in a loss of vehicle control.
- Always check that all passengers' arms, heads or other parts of their body are not outside the vehicle.
- AWD models: This is not an AWD vehicle designed for off-road driving. Proceed with all due caution if it becomes unavoidable to drive off-road.
- Do not drive across a river or through other bodies of water. This may cause electric/electronic components to short circuit, damage the engine or cause other serious damage to the vehicle.

 **WARNING**

- Do not drive in excess of the speed limit. Even if the legal speed limit permits it, do not drive over 85 mph (140 km/h) unless your vehicle has high-speed capability tires. Driving over 85 mph (140 km/h) may result in tire failure, loss of control and possible injury. Be sure to consult a tire dealer to determine whether the tires on your vehicle are high-speed capability tires or not before driving at such speeds.

■ **When driving on slippery road surfaces**

- Sudden braking, acceleration and steering may cause tire slippage and reduce your ability to control the vehicle.
- Sudden acceleration, engine braking due to shifting, or changes in engine speed could cause the vehicle to skid.
- After driving through a puddle, lightly depress the brake pedal to make sure that the brakes are functioning properly. Wet brake pads may prevent the brakes from functioning properly. If the brakes on only one side are wet and not functioning properly, steering control may be affected.

■ **When shifting the shift lever**

- Do not let the vehicle roll backward while the shift lever is in a driving position, or roll forward while the shift lever is in R. Doing so may cause the engine to stall or lead to poor brake and steering performance, resulting in an accident or damage to the vehicle.

- Do not shift the shift lever to P while the vehicle is moving. Doing so can damage the transmission and may result in a loss of vehicle control.

- Do not shift the shift lever to R while the vehicle is moving forward. Doing so can damage the transmission and may result in a loss of vehicle control.

- Do not shift the shift lever to a driving position while the vehicle is moving backward. Doing so can damage the transmission and may result in a loss of vehicle control.

- Shifting the shift lever to N while the vehicle is moving will disengage the engine. Engine braking is not available when N is selected.

- Be careful not to shift the shift lever with the accelerator pedal depressed. Shifting the shift lever to any position other than P or N may lead to unexpected rapid acceleration of the vehicle that may cause an accident and result in death or serious injury.

■ **If you hear a squealing or scraping noise (brake pad wear limit indicators)**

Have the brake pads checked and replaced by your Toyota dealer as soon as possible.

Rotor damage may result if the pads are not replaced when needed.

It is dangerous to drive the vehicle when the wear limits of the brake pads and/or those of the brake discs are exceeded.

**⚠ WARNING****■ When the vehicle is stopped**

- Do not race the engine.  
If the shift lever is in any position other than P or N, the vehicle may accelerate suddenly and unexpectedly, causing an accident.
- In order to prevent accidents due to the vehicle rolling away, always keep depressing the brake pedal while the engine is running, and apply the parking brake as necessary.
- If the vehicle is stopped on an incline, in order to prevent accidents caused by the vehicle rolling forward or backward, always depress the brake pedal and securely apply the parking brake as needed.
- Avoid revving or racing the engine.  
Running the engine at high speed while the vehicle is stopped may cause the exhaust system to overheat, which could result in a fire if combustible material is nearby.

**■ When the vehicle is parked**

- Do not leave glasses, cigarette lighters, spray cans, or soft drink cans in the vehicle when it is in the sun.  
Doing so may result in the following:
  - Gas may leak from a cigarette lighter or spray can, and may lead to a fire.
  - The temperature inside the vehicle may cause the plastic lenses and plastic material of glasses to deform or crack.

- Soft drink cans may fracture, causing the contents to spray over the interior of the vehicle, and may also cause a short circuit in the vehicle's electrical components.
- Do not leave cigarette lighters in the vehicle. If a cigarette lighter is in a place such as the glove box or on the floor, it may be lit accidentally when luggage is loaded or the seat is adjusted, causing a fire.
- Do not attach adhesive discs to the windshield or windows. Do not place containers such as air fresheners on the instrument panel or dashboard. Adhesive discs or containers may act as lenses, causing a fire in the vehicle.
- Do not leave a door or window open if the curved glass is coated with a metallized film such as a silver-colored one. Reflected sunlight may cause the glass to act as a lens, causing a fire.
- Always apply the parking brake, shift the shift lever to P, stop the engine and lock the vehicle. Do not leave the vehicle unattended while the engine is running.  
If the vehicle is parked with the shift lever in P but the parking brake is not set, the vehicle may start to move, possibly leading to an accident.
- Do not touch the exhaust pipes while the engine is running or immediately after turning the engine off.  
Doing so may cause burns.

 **WARNING**

■ **When taking a nap in the vehicle**

Always turn the engine off. Otherwise, if you accidentally move the shift lever or depress the accelerator pedal, this could cause an accident or fire due to engine overheating. Additionally, if the vehicle is parked in a poorly ventilated area, exhaust gases may collect and enter the vehicle, leading to death or a serious health hazard.

■ **When braking**

- When the brakes are wet, drive more cautiously.

Braking distance increases when the brakes are wet, and this may cause one side of the vehicle to brake differently than the other side. Also, the parking brake may not securely hold the vehicle.

- If the brake booster device does not operate, do not follow other vehicles closely and avoid hills or sharp turns that require braking.

In this case, braking is still possible, but the brake pedal should be depressed more firmly than usual. Also, the braking distance will increase. Have your brakes fixed immediately.

- Do not pump the brake pedal if the engine stalls. Each push on the brake pedal uses up the reserve for the power-assisted brakes.

- The brake system consists of 2 individual hydraulic systems; if one of the systems fails, the other will still operate. In this case, the brake pedal should be depressed more firmly than usual and the braking distance will increase. Have your brakes fixed immediately.

■ **If the vehicle becomes stuck (AWD models)**

Do not spin the wheels excessively when any of the tires is up in the air, or the vehicle is stuck in sand, mud, etc. This may damage the driveline components or propel the vehicle forward or backward, causing an accident.

 **NOTICE**

■ **When driving the vehicle**

- Do not depress the accelerator and brake pedals at the same time during driving, as this may restrain the engine output.

- Do not use the accelerator pedal or depress the accelerator and brake pedals at the same time to hold the vehicle on a hill.

■ **When parking the vehicle**

Always set the parking brake and shift the shift lever to P. Failure to do so may cause the vehicle to move or the vehicle may accelerate suddenly if the accelerator pedal is accidentally depressed.

■ **Avoiding damage to vehicle parts**

- Do not turn the steering wheel fully in either direction and hold it there for an extended period of time. Doing so may damage the power steering motor.

**NOTICE**

- When driving over bumps on the road, drive as slowly as possible to avoid damaging the wheels, underside of the vehicle, etc.

■ **If you get a flat tire while driving**

A flat or damaged tire may cause the following situations. Hold the steering wheel firmly and gradually depress the brake pedal to slow down the vehicle.

- It may be difficult to control your vehicle.
- The vehicle will make abnormal sounds or vibrations.
- The vehicle will lean abnormally.

Information on what to do in case of a flat tire (→P.464)

■ **When encountering flooded roads**

Do not drive on a road that has flooded after heavy rain etc. Doing so may cause the following serious damage to the vehicle:

- Engine stalling
- Short in electrical components
- Engine damage caused by water immersion

In the event that you drive on a flooded road and the vehicle is flooded, be sure to have your Toyota dealer check the following:

- Brake function
- Changes in quantity and quality of oil and fluid used for the engine, transaxle, transfer (AWD models), rear differential (AWD models), etc.

- Lubricant condition for the propeller shaft (AWD models), bearings and suspension joints (where possible), and the function of all joints, bearings, etc.

### Cargo and luggage

Take notice of the following information about storage precautions, cargo capacity and load.

### Capacity and distribution

Cargo capacity depends on the total weight of the occupants.

$$(\text{Cargo capacity}) = (\text{Total load capacity}) - (\text{Total weight of occupants})$$

Steps for Determining Correct Load Limit —

- (1) Locate the statement “The combined weight of occupants and cargo should never exceed XXX kg or XXX lbs.” on your vehicle’s placard.
  - (2) Determine the combined weight of the driver and passengers that will be riding in your vehicle.
  - (3) Subtract the combined weight of the driver and passengers from XXX kg or XXX lbs.
  - (4) The resulting figure equals the available amount of cargo and luggage load capacity.
- For example, if the “XXX” amount equals 1400 lbs. and there will be five 150 lb passengers in your vehicle, the amount of available cargo and luggage load capacity is 650 lbs. (1400 –

$$750 (5 \times 150) = 650 \text{ lbs.})$$

(5) Determine the combined weight of luggage and cargo being loaded on the vehicle. That weight may not safely exceed the available cargo and luggage load capacity calculated in Step 4.

(6) If your vehicle will be towing a trailer, load from your trailer will be transferred to your vehicle. Consult this manual to determine how this reduces the available cargo and luggage load capacity of your vehicle. (→P.187)

### Calculation formula for your vehicle

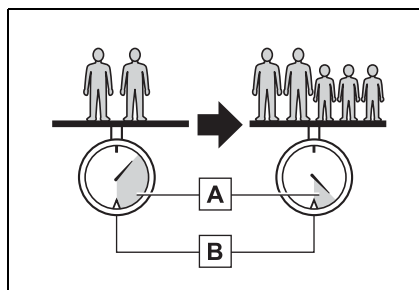

- A** Cargo capacity
- B** Total load capacity (vehicle capacity weight) (→P.492)

When 2 people with the combined weight of A lb. (kg) are riding in your vehicle, which has a total load capacity (vehicle capacity weight) of B lb. (kg), the available amount of cargo and luggage load capacity will



be C lb. (kg) as follows:

$$B^{*2} \text{ lb. (kg)} - A^{*1} \text{ lb. (kg)} = C^{*3} \text{ lb. (kg)}$$

\*1: A =Weight of people

\*2: B =Total load capacity

\*3: C =Available cargo and luggage load

In this condition, if 3 more passengers with the combined weight of D lb. (kg) get on, the available cargo and luggage load will be reduced E lb. (kg) as follows:

$$C \text{ lb. (kg)} - D^{*4} \text{ lb. (kg)} = E^{*5} \text{ lb. (kg)}$$

\*4: D =Additional weight of people

\*5: E =Available cargo and luggage load

As shown in the example above, if the number of occupants increases, the cargo and luggage load will be reduced by an amount that equals the increased weight due to the additional occupants. In other words, if an increase in the number of occupants causes an excess of the total load capacity (combined weight of occupants plus cargo and luggage load), you must reduce the cargo and luggage on your vehicle.

**⚠ WARNING**

■ **Things that must not be carried in the luggage compartment**

The following things may cause a fire if loaded in the luggage compartment:

- Receptacles containing gasoline
  - Aerosol cans
  - **Storage precautions**
- Observe the following precautions. Failure to do so may prevent the pedals from being depressed properly, may block the driver's vision, or may result in items hitting the driver or passengers, possibly causing an accident.
- Stow cargo and luggage in the luggage compartment whenever possible.
  - Do not stack cargo and luggage in the luggage compartment higher than the seatbacks.
  - When you fold down the rear seats, long items should not be placed directly behind the front seats.
  - Never allow anyone to ride in the luggage compartment. It is not designed for passengers. They should ride in their seats with their seat belts properly fastened.
  - Do not place cargo or luggage in or on the following locations.
    - At the feet of the driver
    - On the front passenger or rear seats (when stacking items)
    - On the luggage cover
    - On the instrument panel
    - On the dashboard
  - Secure all items in the occupant compartment.
  - **Capacity and distribution**
  - Do not exceed the maximum axle weight rating or the total vehicle weight rating.

 **WARNING**

● Even if the total load of occupant's weight and the cargo load is less than the total load capacity, do not apply the load unevenly. Improper loading may cause deterioration of steering or braking control which may cause death or serious injury.

■ **When using a roof luggage carrier (vehicles with roof rails)**

Observe the following precautions:

- Place the cargo so that its weight is distributed evenly between the front and rear axles.
- If loading long or wide cargo, never exceed the vehicle overall length or width. (→P.492)
- Before driving, make sure the cargo is securely fastened on the roof luggage carrier.
- Loading cargo on the roof luggage carrier will make the center of gravity of the vehicle higher. Avoid high speeds, sudden starts, sharp turns, sudden braking or abrupt maneuvers, otherwise it may result in loss of control or vehicle rollover due to failure to operate this vehicle correctly and result in death or serious injury.
- If driving for a long distance, on rough roads, or at high speeds, stop the vehicle now and then during the trip to make sure the cargo remains in its place.
- Do not exceed 165 lb. (75 kg) cargo weight on the roof luggage carrier.

 **NOTICE**

■ **When loading cargo**

Be careful not to scratch the surface of the moon roof or panoramic moon roof.

**Vehicle load limits**

**Vehicle load limits include total load capacity, seating capacity, trailer weight rating and cargo capacity.**

- Total load capacity (vehicle capacity weight): →P.492

Total load capacity means the combined weight of occupants, cargo and luggage.

- Seating capacity: →P.492

Seating capacity means the maximum number of occupants whose estimated average weight is 150 lb. (68 kg) per person.

- TWR (Trailer Weight Rating): →P.193, 492

TWR means the maximum gross trailer weight (trailer weight plus its cargo weight) that your vehicle is able to tow.

- Cargo capacity

Cargo capacity may increase or decrease depending on the weight and the number of occupants.

---

■ **Total load capacity and seating capacity**

These details are also described on the tire and loading information label. (→P.423)

**WARNING**

■ **Overloading the vehicle**

Do not overload the vehicle. It may not only cause damage to the tires, but also degrade steering and braking ability, resulting in an accident.

### Trailer towing

Your vehicle is designed primarily as a passenger-and-load-carrying vehicle. Towing a trailer can have an adverse impact on handling, performance, braking, durability, and fuel consumption. For your safety and the safety of others, you must not overload your vehicle or trailer. You must also ensure that you are using appropriate towing equipment, that the towing equipment has been installed correctly and used properly, and that you employ the requisite driving habits.

Vehicle-trailer stability and braking performance are affected by trailer stability, brake performance and setting, trailer brakes, the hitch and hitch systems (if equipped).

To tow a trailer safely, use extreme care and drive the vehicle in accordance with your trailer's characteristics and operating conditions.

Toyota warranties do not apply to damage or malfunction caused by towing a trailer for commercial purposes.

Contact your Toyota dealer for further information about additional requirements such as a towing kit, etc.

#### ■ Matching trailer ball height to trailer coupler height

No matter which class of tow hitch applies, for a more safe trailer hookup, the trailer ball setup must be the proper height for the coupler on the trailer.

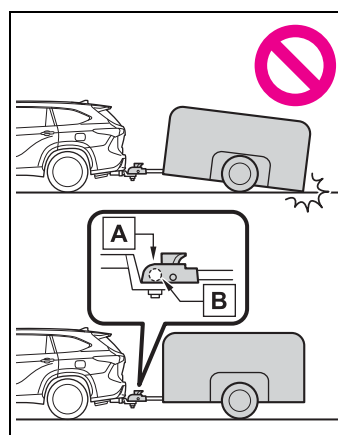

- A** Coupler
- B** Trailer ball

#### ■ Before towing

Check that the following conditions are met:

- Ensure that your vehicle's tires are properly inflated. (→P.499)
- Trailer tires are inflated according to the trailer manufacturer's recommendation.

- All trailer lights work as required by law.
- All lights work each time you connect them.
- The trailer ball is set at the proper height for the coupler on the trailer.
- The trailer is level when it is hitched.  
Do not drive if the trailer is not level, and check for improper tongue weight, overloading, worn suspension, or other possible causes.
- The trailer cargo is securely loaded.
- The rear view mirrors conform to all applicable federal, state/provincial or local regulations. If they do not, install rear view mirrors appropriate for towing purposes.

#### ■ Break-in schedule

If your vehicle is new or equipped with any new power train components (such as an engine, transaxle, transfer [AWD models], rear differential [AWD models] or wheel bearing), Toyota recommends that you do not tow a trailer until the vehicle has been driven for over 500 miles (800 km).

After the vehicle has been driven for over 500 miles (800 km), you can start towing. However, for the next 500 miles (800 km), drive the vehicle at a speed of less than 50 mph (80 km/h) when towing a trailer, and avoid full throttle acceleration.

#### ■ Maintenance

- If you tow a trailer, your vehicle will require more frequent maintenance due to the additional load. (See “Scheduled Maintenance Guide” or “Owner’s Manual Supplement”.)
- Retighten the fixing bolts of the towing ball and bracket after approximately 600 miles (1000 km) of trailer towing.

#### ■ If trailer sway occurs

One or more factors (crosswinds, passing vehicles, rough roads, etc.) can adversely affect handling of your vehicle and trailer, causing instability.

- If trailer swaying occurs:
  - Firmly grip the steering wheel. Steer straight ahead. Do not try to control trailer swaying by turning the steering wheel.
  - Begin releasing the accelerator pedal immediately but very gradually to reduce speed. Do not increase speed. Do not apply vehicle brakes.

If you make no extreme correction with the steering or brakes, your vehicle and trailer should stabilize. (if enabled, Trailer Sway Control can also help to stabilize the vehicle and trailer.)

- After the trailer swaying has stopped:
  - Stop in a safe place. Get all occupants out of the vehicle.
  - Check the tires of the vehicle and the trailer.
  - Check the load in the trailer. Make sure the load has not shifted. Make sure the tongue weight is appropriate, if possible.
  - Check the load in the vehicle. Make sure the vehicle is not overloaded after occupants get in.

If you cannot find any problems, the speed at which trailer swaying occurred is beyond the limit of your particular vehicle-trailer combination. Drive at a lower speed to prevent instability. Remember that swaying of the towing vehicle-trailer increases as speed increases.

 **WARNING**

■ **Trailer towing precautions**

To tow a trailer safely, use extreme care and drive the vehicle in accordance with the trailer's characteristics and operating conditions. Failure to do so could cause an accident resulting in death or serious injury. Vehicle stability and braking performance are affected by trailer stability, brake setting and performance, and the hitch. Your vehicle will handle differently when towing a trailer.

■ **To avoid accident or injury**

- Do not exceed the TWR, unbraked TWR, GCWR, GVWR or GAWR.
- If the gross trailer weight is over 2000 lb. (900 kg), a sway control device with sufficient capacity is required.
- If the gross trailer weight is over 5000 lb. (2200 kg), a weight distributing hitch with sufficient capacity is required.
- Adjust the tongue weight within the appropriate range. Place heavier loads as close to the trailer axle as possible.
- Do not exceed 65 mph (104 km/h), the posted towing speed limit or the speed limit for your trailer as set forth in your trailer owner's manual, whichever is lowest. Slow down sufficiently before making a turn, in cross winds, on wet or slippery surface, etc. to help avoid an accident. If you experience a vehicle-trailer instability from reducing a certain speed, slow down and make sure you keep your vehicle speed under the speed of which you experience the instability.
- Do not make jerky, abrupt or sharp turns.
- Do not apply the brakes suddenly as you may skid, resulting in jackknifing and loss of vehicle control. This is especially true on wet or slippery surfaces.
- Do not exceed the trailer hitch assembly weight, gross vehicle weight, gross axle weight and trailer tongue weight capacities.
- Do not use the following systems when trailer towing.
  - Dynamic radar cruise control with full-speed range
  - LTA (Lane Tracing Assist)
  - PCS (Pre-Collision System)
  - BSM (Blind Spot Monitor) (if equipped)
- Slow down and downshift before descending steep or long downhill grades. Do not make sudden downshifts while descending steep or long downhill grades.
- Vehicle-trailer instability is more likely on steep long downhills. Before descending steep or long downhill grades, slow down and downshift. Do not make sudden downshifts when descending steep or long downhill grades. Avoid holding the brake pedal down too long or applying the brakes too frequently. This could cause the brakes to overheat and result in reduced braking efficiency.
- Vehicles with a compact spare tire: Do not tow a trailer when the compact spare tire is installed on your vehicle.

**⚠ WARNING****■ When towing a trailer**

Toyota recommends trailers with brakes that conform to any applicable federal and state/provincial regulations.

- If the gross trailer weight exceeds unbraked TWR, trailer brakes are required. Toyota recommends trailers with brakes that conform to all applicable federal and state/provincial regulations.
- Never tap into your vehicle's hydraulic system, as this will lower the vehicle's braking effectiveness.
- Never tow a trailer without using a safety chain securely attached to both the trailer and the vehicle. If damage occurs to the coupling unit or hitch ball, there is danger of the trailer wandering into another lane.

**Towing related terms****■ GCWR (Gross Combination Weight Rating)**

The maximum allowable gross combination weight. The gross combination weight is the sum of the total vehicle weight (including the occupants, cargo and any optional equipment installed on the vehicle) and the weight of the trailer being towed (including the cargo in the trailer).

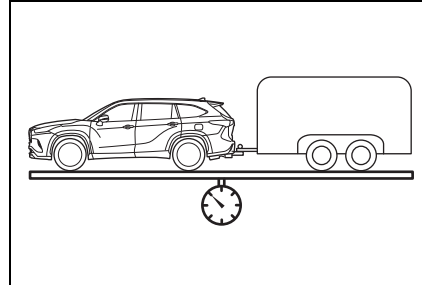
**■ GVWR (Gross Vehicle Weight Rating)**

The maximum allowable gross vehicle weight. The gross vehicle weight is the total weight of the vehicle. When towing a trailer, it is the sum of the vehicle weight (including the occupants, cargo and any optional equipment installed on the vehicle) and the tongue weight.

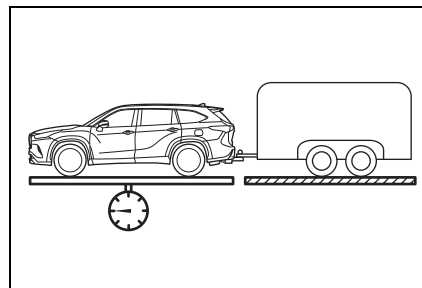
**■ GAWR (Gross Axle Weight Rating)**

The maximum allowable gross axle weight. The gross axle weight is the load placed on each axle (front and rear).

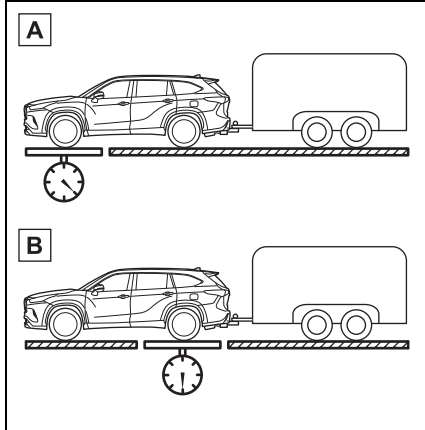

**A** Front GAWR

**B** Rear GAWR

■ **TWR (Trailer Weight Rating)**

The maximum allowable gross trailer weight. The gross trailer weight is the sum of the trailer weight and the weight of the cargo in the trailer.

TWR is calculated assuming base vehicle with one driver, one front passenger, towing package (if available), hitch and hitch systems (if required).

Additional optional equipment, passengers and cargo in the vehicle will reduce the trailer weight rating so as not to exceed GCWR, GVWR and GAWR.

If the gross trailer weight exceeds 3000 lb. (1360 kg), it is recommended to use a trailer with 2 or more axles.

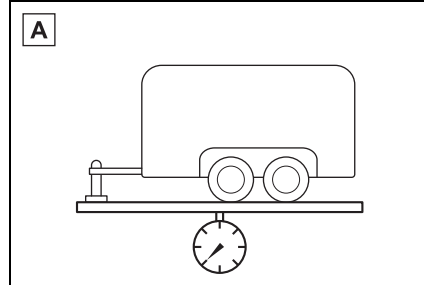

**A** With brakes

■ **Unbraked TWR (Unbraked Trailer Weight Rating)**

The trailer weight rating for towing a trailer without a trailer service brake system.

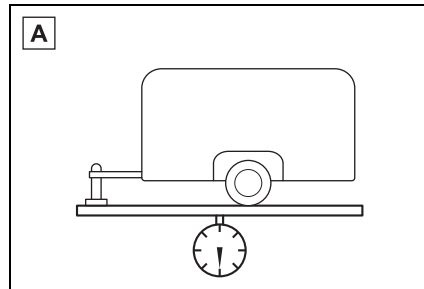

**A** Without brakes

■ **Tongue Weight**

The load placed on the trailer hitch ball. (→P.193)

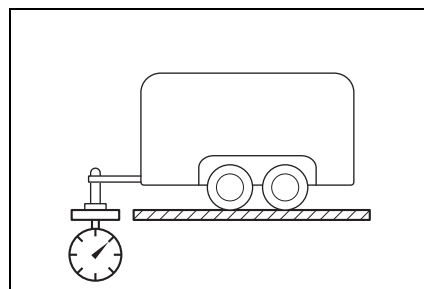



**Weight limits**

- The gross trailer weight must never exceed 5000 lb. (2200 kg).
- The gross combination weight must never exceed the following:
  - 2WD models: 10830 lb. (4845 kg)
  - AWD models: 10935 lb. (4890 kg)
- The gross vehicle weight must never exceed the GVWR indicated on the Certification Label. (→P.492)
- The gross axle weight on each axle must never exceed the GAWR indicated on the Certification Label. (→P.492)
- If the gross trailer weight is over the unbraked TWR, trailer service brakes are required.
- If the gross trailer weight is over 2000 lb. (900 kg), a sway control device with sufficient capacity is required.
- If the gross trailer weight is over 5000 lb. (2200 kg), a weight distributing hitch with sufficient capacity is required.

**GCWR, TWR and Unbraked TWR**

Confirm that the gross trailer weight, gross combination weight, gross vehicle weight, gross axle weight and tongue

weight are all within the limits.

**■ GCWR\***

2WD models: 10830 lb. (4845 kg)

AWD models: 10935 lb. (4890 kg)

**■ TWR\***

5000 lb. (2200 kg)

**■ Unbraked TWR\***

1000 lb. (450 kg)

\*: These models meet the tow-vehicle trailering requirement of SAE International per SAE J2807.

**Trailer Tongue Weight**

- A recommended tongue weight varies in accordance with the types of trailers or towing as described below.
- To ensure the recommended values shown below, the trailer must be loaded by referring to the following instructions.

- Tongue Weight

The gross trailer weight should be distributed so that the tongue weight is 9% to 11%.

(Tongue weight/Gross trailer weight x 100 = 9% to 11%)

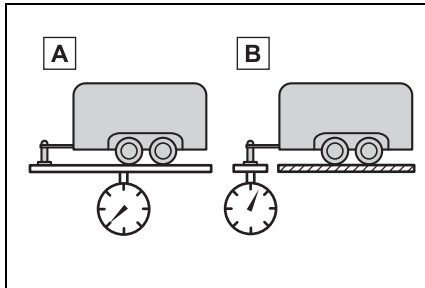

**A** Gross trailer weight

**B** Tongue weight

If using a weight distributing hitch when towing, return the front axle to the same weight as before the trailer connection.

If front axle weight cannot be measured directly, measure the front fender height above the front axle before connection. Adjust weight distributing hitch torque until front fender is returned to the same height as before connection.

The gross trailer weight, gross axle weight and tongue weight can be measured with platform scales found at a highway weighing station, building supply company, trucking company, junk yard, etc.

### Hitch

Trailer hitch assemblies have different weight capacities. Toyota recommends the use of Toyota hitch/bracket for your vehicle. For details, contact your Toyota dealer.

- If you wish to install a trailer hitch, contact your Toyota dealer.
- Use only a hitch that con-

forms to the gross trailer weight requirement of your vehicle.

- Follow the directions supplied by the hitch manufacturer.
- Lubricate the hitch ball with a light coating of grease.
- Remove the hitch ball whenever you are not towing a trailer. Remove the trailer hitch if you do not need it. After removing the hitch, seal any mounting hole in the vehicle body to prevent entry of any substances into the vehicle.

#### ⚠ NOTICE

##### ■ Hitch

Trailer hitch assemblies have different weight capacities established by the hitch manufacturer. Even though the vehicle may be physically capable of towing a higher weight, the operator must determine the maximum weight rating of the particular hitch assembly and never exceed the maximum weight rating specified for the trailer-hitch. Exceeding the maximum weight rating set by the trailer-hitch manufacturer can cause an accident resulting in death or serious personal injuries.

#### ⚠ NOTICE

##### ■ When installing a trailer hitch

Use only the position recommended by your Toyota dealer. Do not install the trailer hitch on the bumper; this may cause body damage.

**Selecting trailer ball**

Use the correct trailer ball for your application.

Trailer class	Typical trailer ball size
IV	2 5/16 in.
II and III	2 in.
I	1 7/8 in.

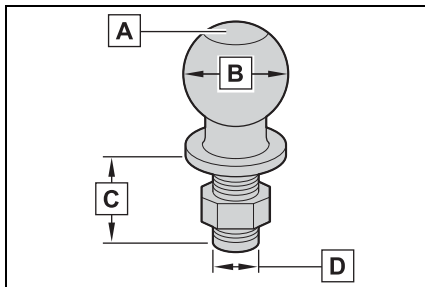

- A** Trailer ball load rating  
Matches or exceeds the gross trailer weight rating of the trailer.
- B** Ball diameter  
Matches the size of the trailer coupler. Most couplers are stamped with the required trailer ball size.
- C** Shank length  
Protrudes beyond the bottom of the lock washer and nut at least 2 threads.
- D** Shank diameter  
Matches the ball mount hole diameter size.

**Positions for towing hitch ball**

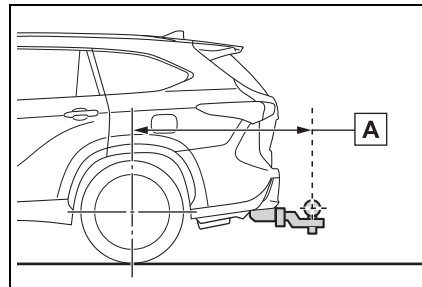

- A** Weight carrying ball position: 50.7 in. (1289 mm)

**Connecting trailer lights**

Use the wire harness stored in the rear end under body.

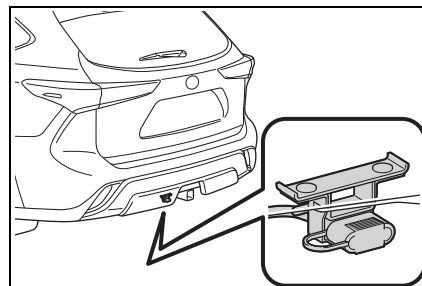

Please consult your dealer when installing trailer lights, as incorrect installation may cause damage to the vehicle's lights. Please take care to comply with your state's laws when installing trailer lights.

**Auto current cut-off function**

In case of over current, the auto cut-off function stops the power flowing to the trailer lights to prevent damage to the vehicle's electrical system.

This function is activated when the rated current of any of the following trailer light circuit components is exceeded:

- Tail lights: maximum 4.5 A
- Stop/turn signal light (right): maximum 7.8 A
- Stop/turn signal light (left): maximum 4.5 A

■ **When the auto current cut function is activated**

If a trailer light does not come on due to the activation of the auto current cut function, the light system will need to be reset.

Follow the reset procedure shown below.

- If a tail light does not come on, turn off the headlight switch.
- If the right-side stop/turn signal light does not come on, put the turn signal in the off position or remove foot from the brake pedal.
- If the left-side stop/turn signal light does not come on, put the turn signal in the off position or remove foot from the brake pedal.

If the emergency flashers do not operate, press the emergency flasher switch to turn them off.

After the light system is reset, operate the light switches again to see if the lights operate normally.

If the lights do not operate normally, have the vehicle inspected by your Toyota dealer.

	<p><b>NOTICE</b></p>
<p>■ <b>Do not directly splice trailer lights</b></p> <p>Do not directly splice trailer lights. Directly splicing trailer lights may damage your vehicle's electrical system and cause a malfunction.</p>	

**Trailer towing tips**

Your vehicle will handle differently when towing a trailer. Help to avoid an accident, death or serious injury, keep the following in mind when towing:

- Speed limits for towing a trailer vary by state or province. Do not exceed the posted towing speed limit.
- Toyota recommends that the vehicle-trailer speed limit is 65 mph (104 km/h) on a flat, straight, dry road. Do not exceed this limit, the posted towing speed limit or the speed limit for your trailer as set forth in your trailer owner's manual, whichever is lowest. Instability of the towing vehicle-trailer combination (trailer sway) increases as speed increases. Exceeding speed limits may cause loss of control.
- Before starting out, check the trailer lights, tires and the vehicle-trailer connections. Recheck after driving a short distance.
- Practice turning, stopping and reversing with the trailer attached in an area away from traffic until you become accustomed to the feel of the vehicle-trailer combination.
- Reversing with a trailer attached is difficult and

requires practice. Grip the bottom of the steering wheel and move your hand to the left to move the trailer to the left. Move your hand to the right to move the trailer to right. (This is generally opposite to reversing without a trailer attached.) Avoid sharp or prolonged turning. Have someone guide you when reversing to reduce the risk of an accident.

- As stopping distance is increased when towing a trailer, vehicle-to vehicle distance should be increased. For each 10 mph (16 km/h) of speed, allow at least one vehicle and trailer length.
- Avoid sudden braking as you may skid, resulting in the trailer jackknifing and a loss of vehicle control. This is especially true on wet or slippery surfaces.
- Avoid jerky starts or sudden acceleration.
- Avoid jerky steering and sharp turns, and slow down before making turn.
- Note that when making a turn, the trailer wheels will be closer than the vehicle wheels to the inside of the turn. Compensate by making a wider than normal turning radius.
- Slow down before making a turn, in cross winds, on wet or slippery surfaces, etc. Increasing vehicle speed can destabilize the trailer.
- Take care when passing other vehicles. Passing requires considerable distance. After passing a vehicle, do not forget the length of your trailer, and be sure you have plenty of room before changing lanes.
- To maintain engine braking efficiency and charging system performance when using engine braking, do not put the transmission in D. If in the M mode, the transmission shift range position must be in 6 or lower. (→P.204)
- Instability happens more frequently when descending steep or long downhill grades. Before descending, slow down and downshift. Do not make sudden downshifts while descending steep or long downhill grades.
- Avoid holding the brake pedal down too long or applying the brakes too frequently. This could cause the brakes to overheat and result in reduced braking efficiency.
- Due to the added load of the trailer, your vehicle's engine may overheat on hot days (at temperatures over 85°F [30°C]) when driving up a long

**198**    **4-1. Before driving**

---

or steep grade. If the engine coolant temperature gauge indicates overheating, immediately turn off the air conditioning (if in use), pull your vehicle off the road and stop in a safe spot. (→P.487)

- Always place wheel blocks under both the vehicle's and the trailer's wheels when parking. Put the transmission in P and apply the parking brake. Avoid parking on a slope, but if unavoidable, do so only after performing the following:

- 1** Apply the brakes and keep them applied.
- 2** Have someone place wheel blocks under both the vehicle's and trailer's wheels.
- 3** When the wheel blocks are in place, release the brakes slowly until the blocks absorb the load.
- 4** Shift into P and apply the parking brake.
- 5** Turn off the engine.

- When restarting after parking on a slope:

- 1** With the transmission in P, start the engine. Be sure to keep the brake pedal depressed.
- 2** Shift into a forward gear. If reversing, shift into R.

- 3** If the parking brake is in manual mode, release the parking brake. (→P.209)
- 4** Release the brake pedal, and slowly pull or back away from the wheel blocks. Stop and apply the brakes.
- 5** Have someone retrieve the blocks.

**Dinghy towing**

**Your vehicle is not designed to be dinghy towed (with 4 wheels on the ground) behind a motor home.**

 NOTICE

■ **To avoid serious damage to your vehicle**

Do not tow your vehicle with the 4 wheels on the ground.

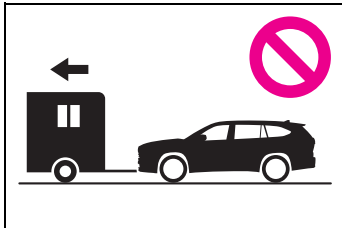

■ **To prevent causing serious damage to the transmission and AWD system**

2WD models: Never tow this vehicle from the rear with the front wheels on the ground.

This may cause serious damage to the transmission.

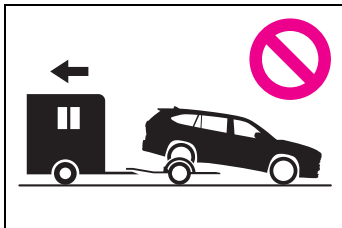

Never dinghy tow your vehicle to prevent causing serious damage to the Dynamic Torque Control AWD system (AWD models) or Dynamic Torque Vectoring AWD system (AWD models) and transmission.

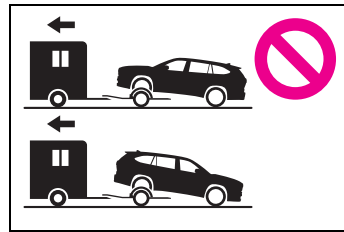

## Engine (ignition) switch

Performing the following operations when carrying the electronic key on your person starts the engine or changes engine switch modes.

### Starting the engine

- 1 Check that the parking brake is set.
- 2 Check that the shift lever is in P.
- 3 Firmly depress the brake pedal.

 and a message will be displayed on the multi-information display.

If it is not displayed, the engine cannot be started.

- 4 Press the engine switch shortly and firmly.

When operating the engine switch, one short, firm press is enough. It is not necessary to press and hold the switch.

The engine will crank until it starts or for up to 30 seconds, whichever is less.

Continue depressing the brake pedal until the engine is completely started.

The engine can be started from any

engine switch mode.

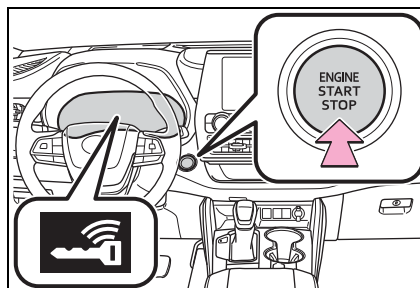

#### ■ If the engine does not start

- The engine immobilizer system may not have been deactivated. (→P.69)  
Contact your Toyota dealer.
- If a message related to start-up is shown on the multi-information display, read the message and follow the instructions.

#### ■ If the battery is discharged

The engine cannot be started using the smart key system. Refer to P.483 to restart the engine.

#### ■ Electronic key battery depletion

→P.112

#### ■ Conditions affecting operation

→P.132

#### ■ Note for the entry function

→P.133

#### ■ Steering lock function

- After turning the engine switch off and opening and closing the doors, the steering wheel will be locked due to the steering lock function. Operating the engine switch again automatically cancels the steering lock.
- When the steering lock cannot be released, "Push Engine Switch while Turning Steering Wheel in Either Direction" will be displayed on the multi-information display. Check that the shift lever is in P. Press the engine switch shortly and firmly while turning the steer-



ing wheel left and right.

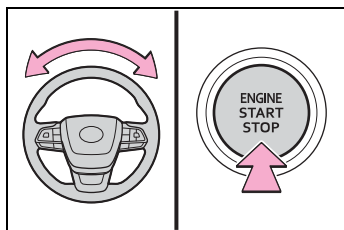

- To prevent the steering lock motor from overheating, operation of the motor may be suspended if the engine is turned on and off repeatedly in a short period of time. In this case, refrain from operating the engine switch. After about 10 seconds, the steering lock motor will resume functioning.

#### ■ Electronic key battery

→P.428

#### ■ Operation of the engine switch

- If the switch is not pressed shortly and firmly, the engine switch mode may not change or the engine may not start.
- If attempting to restart the engine immediately after turning the engine switch off, the engine may not start in some cases. After turning the engine switch off, please wait a few seconds before restarting the engine.

#### ■ Customization

If the smart key system has been deactivated in a customized setting, refer to P.481.

### ⚠ WARNING

#### ■ When starting the engine

Always start the engine while sitting in the driver's seat. Do not depress the accelerator pedal while starting the engine under any circumstances. Doing so may cause an accident resulting in death or serious injury.

#### ■ Caution while driving

If engine failure occurs while the vehicle is moving, do not lock or open the doors until the vehicle reaches a safe and complete stop. Activation of the steering lock in this circumstance may lead to an accident, resulting in death or serious injury.

### ⚠ NOTICE

#### ■ When starting the engine

- Do not race a cold engine.
- If the engine becomes difficult to start or stalls frequently, have your vehicle checked by your Toyota dealer immediately.

#### ■ Symptoms indicating a malfunction with the engine switch

If the engine switch seems to be operating somewhat differently than usual, such as the switch sticking slightly, there may be a malfunction. Contact your Toyota dealer immediately.

### Stopping the engine

- 1 Stop the vehicle completely.
- 2 Set the parking brake (→P.209), and shift the shift lever to P.

Check the parking brake indicator is illuminated.

- 3 Press the engine switch.

The engine will stop, and the meter display will be extinguished.

- 4 Release the brake pedal and check that "ACCESSORY" or "IGNITION ON" is not shown

on the multi-information display.

■ **Automatic engine shut off feature**

- The vehicle is equipped with a feature that automatically shuts off the engine when the shift lever is in P with the engine running for an extended period.
- The engine will automatically shut off after approximately 1 hour if it has been left running while the shift lever is in P.
- The timer for the automatic engine shut off feature will reset if the brake pedal is depressed or if the shift lever is in a position other than P.
- After the vehicle is parked, if the door is locked with the door lock switch (→P.118) from the inside or the mechanical key from the outside, the automatic engine shut off feature will be disabled. The timer for the automatic engine shut off feature will be re-enabled if the driver's door is opened.

 **WARNING**

■ **Stopping the engine in an emergency**

- If you want to stop the engine in an emergency while driving the vehicle, press and hold the engine switch for more than 2 seconds, or press it briefly 3 times or more in succession. (→P.442)

However, do not touch the engine switch while driving except in an emergency. Turning the engine off while driving will not cause loss of steering or braking control, but the power assist to these systems will be lost. This will make it more difficult to steer and brake, so you should pull over and stop the vehicle as soon as it is safe to do so.

- If the engine switch is operated while the vehicle is running, a warning message will be shown on the multi-information display and a buzzer sounds.
- To restart the engine after performing an emergency shut-down, shift the shift lever to N and then press the engine switch.

■ **When parking**

Exhaust gases include harmful carbon monoxide (CO), which is colorless and odorless. Observe the following precautions.

Failure to do so may cause exhaust gases to enter the vehicle and may lead to an accident caused by light-headedness, or may lead to death or a serious health hazard.

- If the vehicle is in a poorly ventilated area or a closed area, such as a garage, stop the engine.

**⚠ WARNING**

- Do not leave the vehicle with the engine running for a long time. If such a situation cannot be avoided, park the vehicle in an open space and ensure that exhaust fumes do not enter the vehicle interior.
- Do not leave the engine running in an area with snow build-up, or where it is snowing. If snow-banks build up around the vehicle while the engine is running, exhaust gases may collect and enter the vehicle.

**Changing engine switch modes**

Modes can be changed by pressing the engine switch with brake pedal released. (The mode changes each time the switch is pressed.)

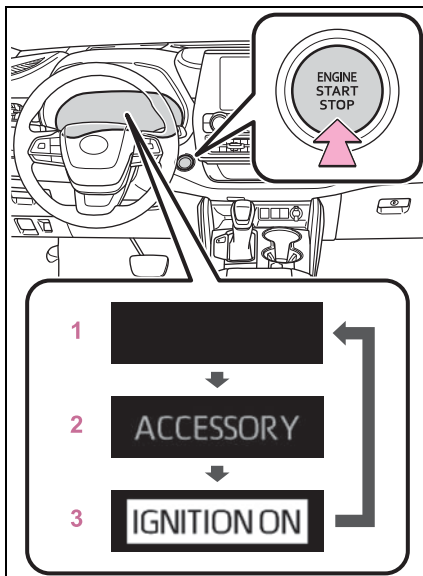

**1 OFF\***

The emergency flashers can be used.

**2 ACC**

Some electrical components such as the audio system can be used. "ACCESSORY" will be displayed on the multi-information display.

**3 ON**

All electrical components can be used.

"IGNITION ON" will be displayed on the multi-information display.

\*: If the shift lever is in a position other than P when turning off the engine, the engine switch will be turned to ACC, not to OFF.

**Auto power off function**

If the vehicle is left in ACC for more than 20 minutes or ON (the engine is not running) for more than an hour with the shift lever in P, the engine switch will automatically turn off. However, this function cannot entirely prevent battery discharge. Do not leave the vehicle with the engine switch in ACC or ON for long periods of time when the engine is not running.

**⚠ NOTICE**

**To prevent battery discharge**

- Do not leave the engine switch in ACC or ON for long periods of time without the engine running.
- If "ACCESSORY" or "IGNITION ON" is displayed on the multi-information display, the engine switch is not off. Exit the vehicle after turning the engine switch off.

**When stopping the engine with the shift lever in a position other than P**

If the engine is stopped with the shift lever in a position other than P, the engine switch will not be turned off but instead be turned to ACC. Perform the following procedure to turn the switch off:

- 1 Check that the parking brake is set.
- 2 Shift the shift lever to P.
- 3 Check that “ACCESSORY” is displayed on the multi-information display and press the engine switch shortly and firmly.
- 4 Check that “ACCESSORY” or “IGNITION ON” on the multi-information display are off.

 **NOTICE**

**■ To prevent battery discharge**  
Do not stop the engine when the shift lever is in a position other than P. If the engine is stopped in another shift lever position, the engine switch will not be turned off but instead be turned to ACC. If the vehicle is left in ACC, battery discharge may occur.

**Automatic transmission**

**Select the shift position depending on your purpose and situation.**

**Shift position purpose**

Shift position	Objective or function
P	Parking the vehicle/starting the engine
R	Reversing
N	Neutral
D	Normal driving*1
M	M mode driving*2 (→P.206)

\*1: Shifting to the D position allows the system to select a gear suitable for the driving conditions. Setting the shift lever to the D position is recommended for normal driving.

\*2: Selecting gears using M mode fixes the gear step, controls engine braking force, and prevents unnecessary upshifting.

**■ To protect the automatic transmission**

If the automatic transmission fluid temperature is high, “High Transmission Fluid Temp See Owner's Manual” will be displayed on the multi-information display and the vehicle will go into transmission protection mode automatically. Have the vehicle inspected by your Toyota dealer.

### ■ When driving with dynamic radar cruise control with full-speed range activated

Even when switching the driving mode to sport mode with the intent of enabling engine braking, engine braking will not activate because dynamic radar cruise control with full-speed range will not be canceled.

### ■ Restraining sudden start (Drive-Start Control)

→P.178

### ■ AI-SHIFT

- The AI-SHIFT automatically selects the suitable gear according to driver performance and driving conditions.

The AI-SHIFT automatically operates when the shift lever is in D. (Shifting the shift lever to the M position cancels the function.)

- G AI-SHIFT automatically selects a suitable gear for sporty driving according to driver's input and driving conditions. G AI-SHIFT operates automatically when the shift lever is in D and sport mode is selected for the driving mode. (Selecting normal mode with the driving mode select switch or shifting the shift lever to the M position cancels this function.)

### WARNING

#### ■ When driving on slippery road surfaces

Be careful of downshifting and sudden acceleration, as this could result in the vehicle skidding to the side or spinning.

### Shifting the shift lever

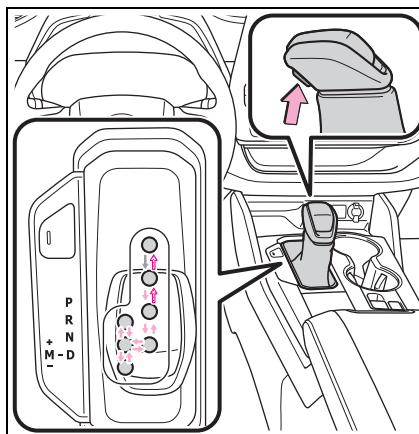

←: While the engine switch is in ON and the brake pedal depressed\*, shift the shift lever while pushing the shift release button on the shift knob.

←: Shift the shift lever while pushing the shift release button on the shift knob.

←: Shift the shift lever normally.

When shifting the shift lever between P and D, make sure that the vehicle is completely stopped.

\*: For the vehicle to be able to be shifted from P, the brake pedal must be depressed before the shift release button is pushed. If the shift release button is pushed first, the shift lock will not be released.

### ■ Shift lock system

The shift lock system is a system to prevent accidental operation of the shift lever in starting.

The shift lever can be shifted from P only when the engine switch is in

ON and the brake pedal is being depressed.

■ **If the shift lever cannot be shifted from P**

First, check whether the brake pedal is being depressed.

If the shift lever cannot be shifted with your foot on the brake pedal, there may be a problem with the shift lock system. Have the vehicle inspected by your Toyota dealer immediately.

The following steps may be used as an emergency measure to ensure that the shift lever can be shifted.

Releasing the shift lock:

- 1 Turn the engine switch to ON and check that the parking brake is set. (→P.203, 209)
- 2 Turn the engine switch to off.
- 3 Depress the brake pedal.
- 4 Pry the cover up with a flathead screwdriver or equivalent tool.

To prevent damage to the cover, cover the tip of the screwdriver with a rag.

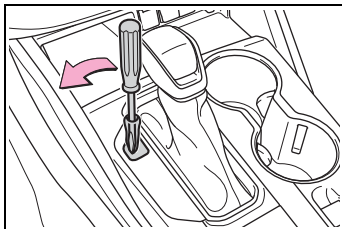

- 5 Press and hold the shift lock override button.

The shift lever can be shifted while both buttons are pressed.

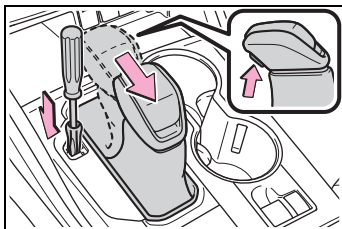

**! WARNING**

■ **To prevent an accident when releasing the shift lock**

Before pressing the shift lock override button, make sure to set the parking brake and depress the brake pedal.

If the accelerator pedal is accidentally depressed instead of the brake pedal when the shift lock override button is pressed and the shift lever is shifted out of P, the vehicle may suddenly start, possibly leading to an accident resulting in death or serious injury.

**Selecting the driving mode and snow mode**

→P.306, 310

**Selecting gears in the M position**

To enter M mode, shift the shift lever to M. Gears can then be selected by operating the shift lever, allowing you to drive in the gear of your choosing.

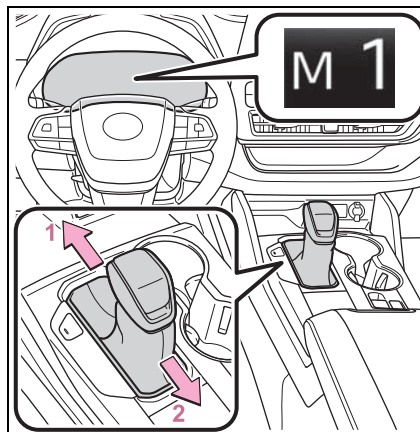

**1** Upshifting**2** Downshifting

The gear changes once every time the shift lever or paddle shift switch is operated.

The selected gear, from M1 to M8, will be fixed and displayed on the meters.

When in the M position, the gear will not change unless the shift lever is operated.

However, even when in the M position, the gears will be automatically changed in the following situation:

- When vehicle speed drops (downshift only).
- When the automatic transmission fluid or engine coolant temperature is low.
- When automatic transmission fluid temperature is high (upshift only).
- When the needle of the tachometer is in the red zone (the range which exceeds the allowable revs of the engine).

In the following situations, the gear will not shift even if the shift lever is operated.

- The vehicle speed is low (upshift only).

---

**■ Downshifting restriction warning buzzer**

To help ensure safety and driving performance, downshifting operation may sometimes be restricted. In some circumstances, downshifting

may not be possible even when the paddle shift switch is operated. (A buzzer will sound twice.)

### Turn signal lever

burned out.

### Operating instructions

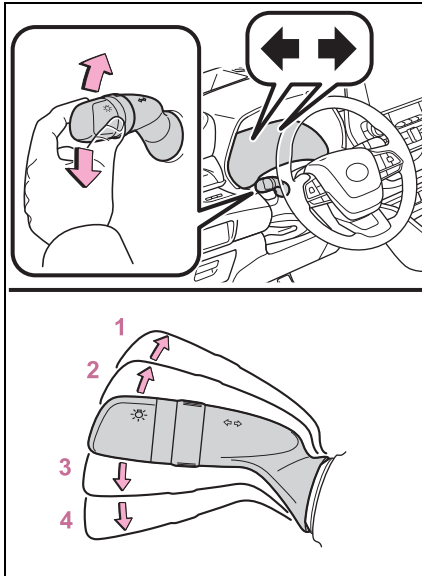

- 1** Right turn
- 2** Lane change to the right  
(move the lever partway and release it)  
The right hand signals will flash 3 times.
- 3** Lane change to the left  
(move the lever partway and release it)  
The left hand signals will flash 3 times.
- 4** Left turn

■ **Turn signals can be operated when**

The engine switch is in ON.

■ **If the indicator flashes faster than usual**

Check that a light bulb in the front or rear turn signal lights has not



**Parking brake**

The parking brake can be set or released automatically or manually.

In automatic mode, the parking brake can be set or released automatically according to the shift lever operation. Also, even in automatic mode, the parking brake can be set or released manually.

**Operating instructions**

■ **Using the manual mode**

The parking brake can be set and released manually.

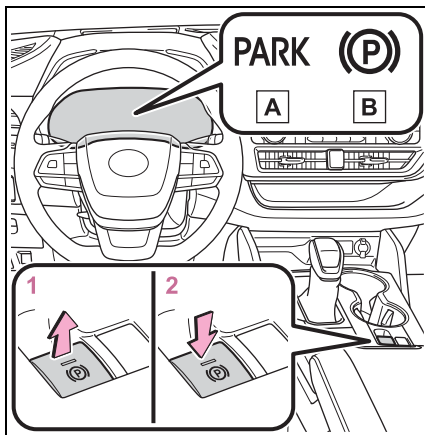

**A** U.S.A.

**B** Canada

- 1** Pull the switch to set the parking brake

The parking brake indicator light and parking brake light will turn on.

Pull and hold the parking brake switch if an emergency occurs and it is necessary to operate the parking brake while driving.

- 2** Push the switch to release the parking brake
  - Operate the parking brake switch while depressing the brake pedal.
  - Parking brake automatic release function (→P.210)

Make sure that the parking brake indicator light and parking brake light turn off.

If the parking brake indicator light and parking brake light flashes, operate the switch again. (→P.457)

■ **Turns automatic mode on**

While the vehicle is stopped, pull and hold the parking brake switch until a “EPB Shift Interlock Function Activated” is shown on the multi-information display.

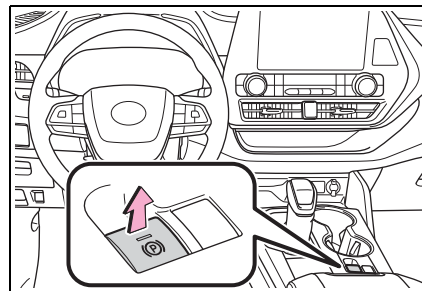

When the automatic mode is turned on, the parking brake operates as follows.

- When the shift lever is moved out of P, the parking brake will be released, and the parking brake indicator light and parking brake light turn off.

- When the shift lever is moved into P, the parking brake will be set, and the parking brake indicator light and parking brake light turn on.

Operate the shift lever with the brake pedal depressed.

■ **Turns automatic mode off**

While the vehicle is stopped, press and hold the parking brake switch until a “EPB Shift Interlock Function Deactivated” is shown on the multi-information display.

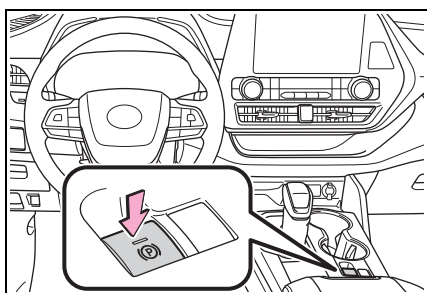

■ **Parking brake operation**

- When the engine switch is not in ON, the parking brake cannot be released using the parking brake switch.
- When the engine switch is not in ON, automatic mode (automatic brake setting and releasing) is not available.

■ **Parking brake automatic release function**

The parking brake will be released automatically when the accelerator pedal is slowly depressed under the following conditions:

- The driver's door is closed
- The driver is wearing the seat belt
- The shift lever is in a forward or

reverse position.

- The malfunction indicator lamp or brake system warning light is not illuminated

If the automatic release function does not operate, release the parking brake manually.

■ **If “Parking Brake Temporarily Unavailable” is displayed on the multi-information display**

If the parking brake is operated repeatedly over a short period of time, the system may restrict operation to prevent overheating. If this happens, refrain from operating the parking brake. Normal operation will return after about 1 minute.

■ **If “Parking Brake Unavailable” is displayed on the multi-information display**

Operate the parking brake switch. If the message does not disappear after operating the switch several times, the system may be malfunctioning. Have the vehicle inspected by your Toyota dealer immediately.

■ **Parking brake operation sound**

When the parking brake operates, a motor sound (whirring sound) may be heard. This does not indicate a malfunction.

■ **Parking brake indicator light and parking brake light**

- Depending on the engine switch mode, the parking brake indicator light and parking brake light will turn on and stay on as described below:  
ON: Comes on until the parking brake is released.  
Not in ON: Stays on for approximately 15 seconds.
- When the engine switch is turned off with the parking brake set, the parking brake indicator light and parking brake light will stay on for about 15 seconds. This does not indicate a malfunction.

### ■ When the parking brake switch malfunctions

Automatic mode (automatic brake setting and releasing) will be turned on automatically.

### ■ Parking the vehicle

→P.177

### ■ Parking brake engaged warning buzzer

A buzzer will sound if the vehicle is driven with the parking brake engaged. "Parking Brake ON" is displayed on the multi-information display.

### ■ Warning messages and buzzers

Warning messages and buzzers are used to indicate a system malfunction or to inform the driver of the need for caution. If a warning message is shown on the multi-information display, read the message and follow the instructions.

### ■ If the brake system warning light comes on

→P.450

### ■ Usage in winter time

→P.319

### NOTICE

#### ■ When parking the vehicle

Before you leave the vehicle, shift the shift lever to P, set the parking brake and make sure that the vehicle does not move.

#### ■ When the system malfunctions

Stop the vehicle in a safe place and check the warning messages.

#### ■ When the parking brake cannot be released due to a malfunction

Driving the vehicle with the parking brake set will lead to brake components overheating, which may affect braking performance and increase brake wear.

Have the vehicle inspected by your Toyota dealer immediately if this occurs.

### WARNING

#### ■ When parking the vehicle

Do not leave a child in the vehicle alone. The parking brake may be released unintentionally and there is the danger of the vehicle moving that may lead to an accident resulting in death or serious injury.

#### ■ Parking brake switch

Do not set any objects near the parking brake switch. Objects may interfere with the switch and may lead the parking brake to unexpectedly operate.

## Brake Hold

The brake hold system keeps the brake applied when the shift lever is in D, M or N with the system on and the brake pedal has been depressed to stop the vehicle. The system releases the brake when the accelerator pedal is depressed with the shift lever in D or M to allow smooth start off.

### Enabling the system

Turns the brake hold system on

The brake hold standby indicator (green) **A** comes on. While the system is holding the brake, the brake hold operated indicator (yellow) **B** comes on.

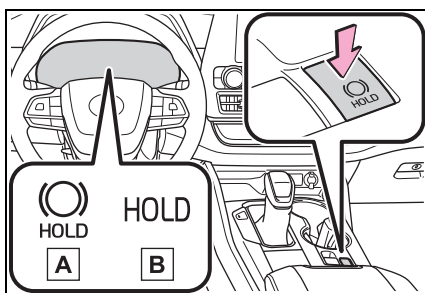

### Brake hold system operating conditions

The brake hold system cannot be turned on in the following conditions:

- The driver's door is not closed.
- The driver is not wearing the seat belt.

- The parking brake is engaged.

If any of the conditions above are detected when the brake hold system is enabled, the system will turn off and the brake hold standby indicator light will go off. In addition, if any of the conditions are detected while the system is holding the brake, a warning buzzer will sound and a message will be shown on the multi-information display. The parking brake will then be set automatically.

### Brake hold function

- If the brake pedal is left released for a period of about 3 minutes after the system has started holding the brake, the parking brake will be set automatically. In this case, a warning buzzer sounds and a message is shown on the multi-information display.
- To turn the system off while the system is holding the brake, firmly depress the brake pedal and press the button again.
- The brake hold function may not hold the vehicle when the vehicle is on a steep incline. In this situation, it may be necessary for the driver to apply the brakes. A warning buzzer will sound and the multi-information display will inform the driver of this situation. If a warning message is shown on the multi-information display, read the message and follow the instructions.

### When the parking brake is set automatically while the system is holding the brakes

Perform any of the following operations to release the parking brake.

- Depress the accelerator pedal. (The parking brake will not be released automatically if the seat belt is not fastened.)
- Operate the parking brake switch with the brake pedal depressed.

Make sure that the parking brake

indicator light goes off. (→P.209)

■ **When an inspection at your Toyota dealer is necessary**

When the brake hold standby indicator (green) does not illuminate even when the brake hold switch is pressed with the brake hold system operating conditions met, the system may be malfunctioning. Have the vehicle inspected at your Toyota dealer.

■ **If “Brake Hold Malfunction Press Brake to Deactivate Visit Your Dealer” or “Brake Hold Malfunction Visit Your Dealer” is displayed on the multi-information display**

The system may be malfunctioning. Have the vehicle inspected by your Toyota dealer.

■ **Warning messages and buzzers**

Warning messages and buzzers are used to indicate a system malfunction or to inform the driver of the need for caution. If a warning message is shown on the multi-information display, read the message and follow the instructions.

■ **If the brake hold operated indicator flashes**

→P.457



**NOTICE**

■ **When parking the vehicle**

The brake hold system is not designed for use when parking the vehicle for a long period of time. Turning the engine switch off while the system is holding the brake may release the brake, which would cause the vehicle to move. When operating the engine switch, depress the brake pedal, shift the shift lever to P and set the parking brake.



**WARNING**

■ **When the vehicle is on a steep incline**

When using the brake hold system on a steep incline, exercise caution. The brake hold function may not hold the vehicle in such a situation.

■ **When stopped on a slippery road**

The system cannot stop the vehicle when the gripping ability of the tires has been exceeded. Do not use the system when stopped on a slippery road.

### Headlight switch

The headlights can be operated manually or automatically.

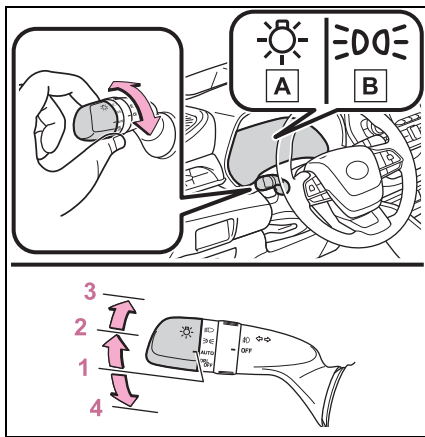

### Operating instructions

Operating the  switch turns on the lights as follows:



**A** U.S.A.



**B** Canada

- 1**  The headlights, daytime running lights (→P.214) and all the lights listed below turn on and off automatically. (When the engine switch is in ON.)
- 2**  The side marker, parking, tail, license plate, instrument panel lights, and daytime running lights (→P.214) turn on.
- 3**  The headlights and all

lights listed above (except daytime running lights) turn on.

**4**  (U.S.A.) Off

### Daytime running light system

- Vehicles without projector headlights: The daytime running lights illuminate using the same lights as the low beam headlights and illuminate dimmer than the low beam headlights.
- Vehicles with projector headlights: The daytime running lights illuminate using the same lights as the parking lights and illuminate brighter than the parking lights.
- To make your vehicle more visible to other drivers during daytime driving, the daytime running lights turn on automatically when all of the following conditions are met. (The daytime running lights are not designed for use at night.)
  - The engine is running
  - The parking brake is released
  - The headlight switch is in the  or  position

\*: When the surroundings are bright

The daytime running lights remain on after they illuminate, even if the parking brake is set again.

- For the U.S.A.: Daytime running lights can be turned off by operating the switch.
- Compared to turning on the headlights, the daytime running light system offers greater durability and consumes less electricity, so it can help improve fuel economy.

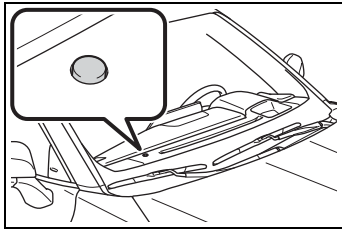

■ **Headlight control sensor**





The sensor may not function properly if an object is placed on the sensor, or anything that blocks the sensor is affixed to the windshield. Doing so interferes with the sensor detecting the level of ambient light and may cause the automatic headlight system to malfunction.

■ **Automatic light off system**

- When the headlights are on: The headlights and tail lights turn off 30 seconds after the driver's door is opened and closed if the engine switch is turned to ACC or OFF. (The lights turn off immediately if  on the key is pressed after all the doors are closed.)
- When only the tail lights are on: The tail lights turn off automatically if the engine switch is turned to ACC or OFF and the driver's door is opened.

Except for Canada: To turn the lights on again, turn the engine switch to ON, or turn the light switch off once and then back to  or .

For Canada: To turn the lights on again, turn the engine switch to ON, or turn the light switch to AUTO once and then back to  or .

■ **Automatic headlight leveling system (if equipped)**

The level of the headlights is automatically adjusted according to the number of passengers and the loading condition of the vehicle to ensure that the headlights do not

interfere with other road users.

■ **Light reminder buzzer**

A buzzer sounds when the engine switch is turned off or turned to ACC and the driver's door is opened while the lights are turned on.

■ **Welcome lighting**

The parking lights and tail lights automatically turn on at night when the doors are unlocked using the entry function or wireless remote control if the light switch is in the AUTO position.

■ **Windshield wiper linked headlight illumination**

When driving during daytime with the headlight switch turned to AUTO, if the windshield wipers are used, the headlights will turn on automatically after several seconds to help enhance the visibility of your vehicle.

■ **Battery-saving function**

In order to prevent the battery of the vehicle from discharging, if the headlights and/or tail lights are on when the engine switch is turned off the battery saving function will operate and automatically turn off all the lights after approximately 20 minutes. When the engine switch is turned to ON, the battery-saving function will be disabled.

When any of the following are performed, the battery-saving function is canceled once and then reactivated. All the lights will turn off automatically 20 minutes after the battery-saving function has been reactivated:

- When the headlight switch is operated
- When a door is opened or closed

■ **Customization**

Some functions can be customized. (→P.515)



**NOTICE**

■ **To prevent battery discharge**

Do not leave the lights on longer than necessary when the engine is off.

**Turning on the high beam headlights**

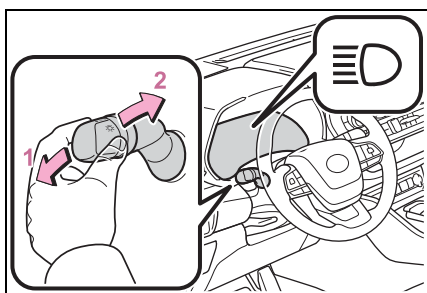

- 1 With the headlights on, push the lever away from you to turn on the high beams.

Pull the lever toward you to the center position to turn the high beams off.

- 2 Pull the lever toward you and release it to flash the high beams once.

You can flash the high beams with the headlights on or off.

**AFS (Adaptive Front-lighting System) (if equipped)**

AFS (Adaptive Front-lighting System) secures excellent visibility at intersections and on curves by automatically adjusting the direction of the light axis of the headlights according to vehicle speed and the degree of the tire's angle as controlled by

steering input.

AFS operates at speeds of 6 mph (10 km/h) or higher.

■ **Customization**

Some functions can be customized. (→P.515)



**Automatic High Beam**

The Automatic High Beam uses a camera sensor located behind the upper portion of the windshield to assess the brightness of the lights of vehicles ahead, streetlights, etc., and automatically turns the high beams on or off as necessary.

**⚠ WARNING**

■ **Limitations of the Automatic High Beam**

Do not overly rely on the Automatic High Beam. Always drive safely, taking care to observe your surroundings and turning the high beams on or off manually if necessary.

■ **To prevent incorrect operation of the Automatic High Beam system**

Do not overload the vehicle.

**Activating the Automatic High Beam**

- 1 Press the Automatic High Beam switch.

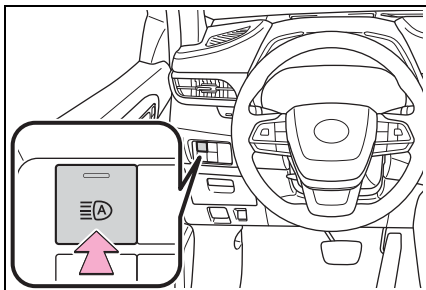

- 2 Push the lever away from you with the headlight switch in the AUTO or  position.

The Automatic High Beam indicator will come on when the system is operating.

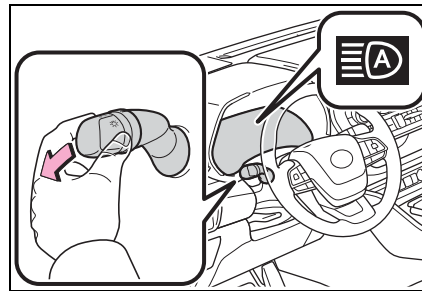

■ **Conditions to turn the high beams on/off automatically**

- When all of the following conditions are met, the high beams will be turned on automatically (after approximately 1 second):
  - The vehicle speed is approximately 21 mph (34 km/h) or more.
  - The area ahead of the vehicle is dark.
  - There are no vehicles ahead with headlights or tail lights turned on.
  - There are few streetlights on the road ahead.
- If any of the following conditions is met, the high beams will turn off automatically:
  - The vehicle speed is below approximately 17 mph (27 km/h).
  - The area ahead of the vehicle is not dark.
  - Vehicles ahead have their headlights or tail lights turned on.
  - There are many streetlights on the road ahead.
- **Camera sensor detection information**
  - The high beams may not be automatically turned off in the following situations:
    - When a vehicle suddenly appears

## 218 4-3. Operating the lights and wipers

---

- from around a curve
- When the vehicle is cut in front of by another vehicle
- When vehicles ahead cannot be detected due to repeated curves, road dividers or roadside trees
- When vehicles ahead appear in a faraway lane on a wide road
- When the lights of vehicles ahead are not on
- The high beams may be turned off if a vehicle ahead that is using fog lights without its headlights turned on is detected.
- House lights, street lights, traffic signals, and illuminated billboards or signs and other reflective objects may cause the high beams to change to the low beams, or the low beams to remain on.
- The following factors may affect the amount of time taken for the high beams to turn on or off:
  - The brightness of the headlights, fog lights, and tail lights of vehicles ahead
  - The movement and direction of vehicles ahead
  - When a vehicle ahead only has operational lights on one side
  - When a vehicle ahead is a two-wheeled vehicle
  - The condition of the road (gradient, curve, condition of the road surface, etc.)
  - The number of passengers and amount of luggage in the vehicle
- The high beams may turn on or off unexpectedly.
- Bicycles or similar vehicles may not be detected.
- In the following situations the system may not be able to correctly detect the surrounding brightness level. This may cause the low beams to remain on or the high beams to flash or dazzle pedestrians or vehicles ahead. In such a case, it is necessary to manually switch between the high and low beams.
  - When driving in inclement weather (heavy rain, snow, fog, sandstorms, etc.)
  - When the windshield is obscured by fog, mist, ice, dirt, etc.
  - When the windshield is cracked or damaged
  - When the camera sensor is deformed or dirty
  - When the temperature of the camera sensor is extremely high
  - When the surrounding brightness level is equal to that of headlights, tail lights or fog lights
  - When headlights or tail lights of vehicles ahead are turned off, dirty, changing color, or not aimed properly
  - When the vehicle is hit by water, snow, dust, etc. from a preceding vehicle
  - When driving through an area of intermittently changing brightness and darkness
  - When frequently and repeatedly driving ascending/descending roads, or roads with rough, bumpy or uneven surfaces (such as stone-paved roads, gravel roads, etc.)
  - When frequently and repeatedly taking curves or driving on a winding road
  - When there is a highly reflective object ahead of the vehicle, such as a sign or mirror
  - When the back of a preceding vehicle is highly reflective, such as a container on a truck
  - When the vehicle's headlights are damaged or dirty, or are not aimed properly
  - When the vehicle is listing or titling due to a flat tire, a trailer being towed, etc.
  - When the headlights are changed between the high beams and low beams repeatedly in an abnormal manner
  - When the driver believes that the high beams may be flashing or dazzling pedestrians or other drivers

■ **Temporarily lowering sensor sensitivity**

The sensitivity of the sensor can be temporarily lowered.

1 Turn the engine switch off while the following conditions are met.

- The headlight switch is in AUTO or



- The headlight switch lever is in high beam position.

- Automatic High Beam switch is on.

2 Turn the engine switch to ON.

3 Within 60 seconds after step 2, repeat pulling the headlight switch lever to the original position then pushing it to the high beam position quickly 10 times, then leave the lever in high beam position.

4 If the sensitivity is changed, the Automatic High Beam indicator is turn on and off 3 times.

Automatic High Beam (headlights) may turn on even when the vehicle is stopped.

**Turning the high beams on/off manually**

■ **Switching to the low beams**

Pull the lever to its original position.

The Automatic High Beam indicator will turn off.

Push the lever away from you to activate the Automatic High Beam system again.

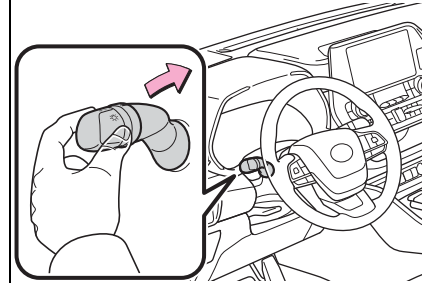

■ **Switching to the high beams**

Press the Automatic High Beam switch.

The Automatic High Beam indicator will turn off and the high beam indicator will turn on.

Press the switch to activate the Automatic High Beam system again.

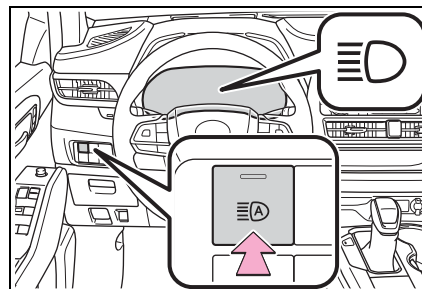



### Fog light switch\*

\*: If equipped

The fog lights secure excellent visibility in difficult driving conditions, such as in rain and fog.

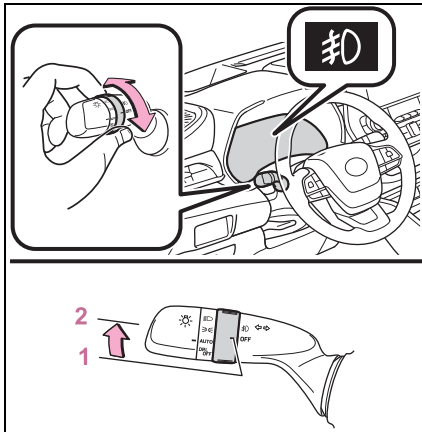
### Operating instructions



- 1** OFF (U.S.A.) or  (Canada)  
Turns the fog lights off
- 2**  Turns the fog lights on

■ **Fog lights can be used when**  
The headlights are on in low beam.

### Windshield wipers and washer

Operating the lever can switch between automatic operation and manual operation, or can use the washer.

 NOTICE



■ **When the windshield is dry**  
Do not use the wipers, as they may damage the windshield.

### Operating the wiper lever

Operate the  lever operates the wipers or washer as follows.

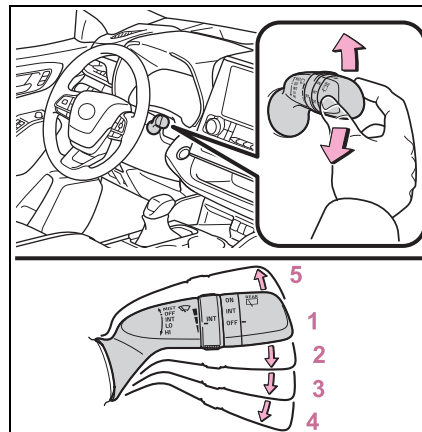
- ▶ Intermittent windshield wipers with interval adjuster



- 1** OFF (U.S.A.) or  (Canada)  
Off
- 2** INT (U.S.A.) or  (Canada)  
Intermittent operation

- 3** LO (U.S.A.) or ▼ (Canada)  
Low speed operation
- 4** HI (U.S.A.) or ▼ (Canada)  
High speed operation
- 5** MIST (U.S.A.) or ▲ (Canada)  
Temporary operation

Wiper intervals can be adjusted when intermittent operation is selected.

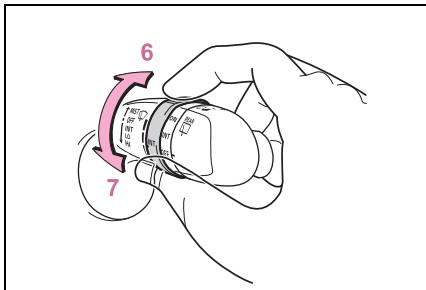

- 6** Increases the intermittent windshield wiper frequency
- 7** Decreases the intermittent windshield wiper frequency

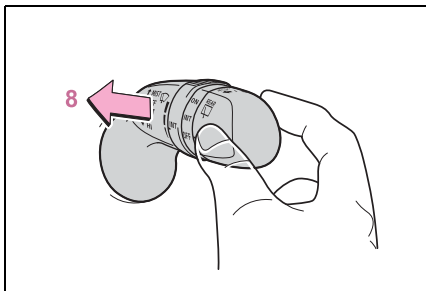

- 8**  Washer/wiper dual operation  
Pulling the lever operates the wipers and washer.  
Wipers will automatically operate a couple of times after the washer squirts.

► Rain-sensing windshield wipers

When “AUTO” is selected, the wipers will operate automatically when the sensor detects falling rain. The system automatically adjusts wiper timing in accordance with rain volume and vehicle speed.

The sensor sensitivity can be adjusted when “AUTO” is selected.

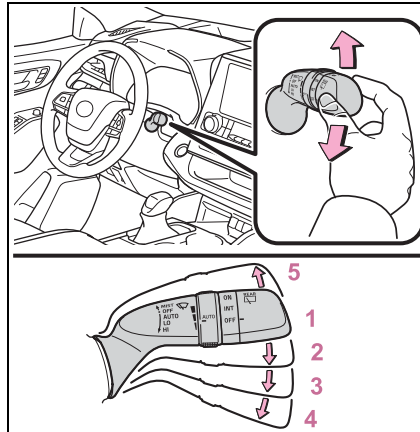

- 1** OFF (U.S.A.) or ● (Canada)  
Off
- 2** AUTO Rain-sensing wiper operation
- 3** LO (U.S.A.) or ▼ (Canada)  
Low speed operation
- 4** HI (U.S.A.) or ▼ (Canada)  
High speed operation
- 5** MIST (U.S.A.) or ▲ (Canada)  
Temporary operation

When AUTO mode is selected,

the sensor sensitivity can be adjusted by turning the switch ring.

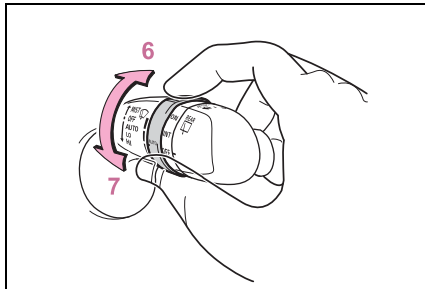

- 6 Increases the sensitivity
- 7 Decreases the sensitivity

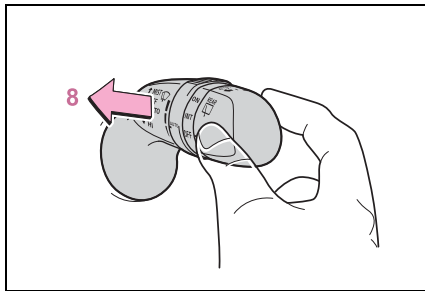

**8**  Washer/wiper dual operation

Pulling the lever operates the wipers and washer. The wipers will automatically operate a couple of times after the washer squirts.

■ **The windshield wipers and washer can be operated when**

The engine switch is in ON.

■ **Dripping prevention wiper sweep**

After washing and wiping operation several times, the wipers operate one more time after a short delay to prevent dripping. However, this function will not operate while driving.

■ **Effects of vehicle speed on wiper operation**

Vehicle speed affects the intermittent wiper interval.

■ **Raindrop sensor (vehicles with rain-sensing windshield wipers)**

- The raindrop sensor judges the amount of raindrops. An optical sensor is adopted. It may not operate properly when sunlight from the rising or setting of the sun intermittently strikes the windshield, or if bugs, etc. are present on the windshield

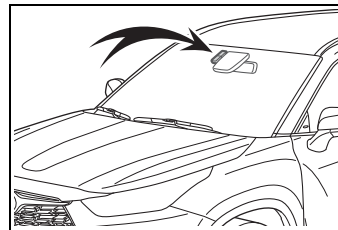

- If the wiper switch is turned to the "AUTO" position while the engine switch is in ON, the wipers will operate once to show that AUTO mode is activated.

- When the sensor sensitivity ring is turned toward high while in "AUTO" position, the wipers will operate once to indicate that the sensor sensitivity is enhanced.

- If the temperature of the raindrop sensor is 185°F (85°C) or higher, or 5°F (-15°C) or lower, automatic operation may not occur. In this case, operate the wipers in any mode other than AUTO mode.

■ **If no windshield washer fluid sprays**

Check that the washer nozzles are not blocked, if there is washer fluid in the washer fluid tank.

■ **Front door opening linked windshield wiper stop function (vehicles with rain-sensing windshield wipers)**

When "AUTO" is selected and the

windshield wipers are operating, if a front door is opened, the operation of the windshield wipers will be stopped to prevent anyone entering/exiting the vehicle from being sprayed by water from the wipers, provided the vehicle is stopped with the parking brake applied or the shift lever in P. When the front door is closed, wiper operation will resume.

**⚠ WARNING**

■ **Caution regarding the use of windshield wipers in AUTO mode (vehicles with rain-sensing windshield wipers)**

The windshield wipers may operate unexpectedly if the sensor is touched or the windshield is subject to vibration in AUTO mode. Take care that your fingers, etc. do not become caught in the windshield wipers.

■ **Caution regarding the use of washer fluid**

When it is cold, do not use the washer fluid until the windshield becomes warm. The fluid may freeze on the windshield and cause low visibility. This may lead to an accident, resulting in death or serious injury.

**⚠ NOTICE**

■ **When the washer fluid tank is empty**

Do not operate the switch continually as the washer fluid pump may overheat.

■ **When a nozzle becomes blocked**

In this case, contact your Toyota dealer.  
Do not try to clear it with a pin or other object. The nozzle will be damaged.

**Rear windshield wiper and washer**

**⚠ NOTICE**

■ **When the rear window is dry**

Do not use the wiper, as it may damage the rear window.

**Operating the wiper lever**

Operating the  switch operates the rear wiper as follows.

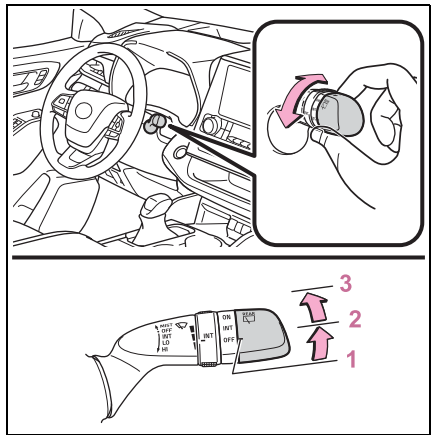

- 1** OFF (U.S.A.) or ○ (Canada)  
Off
- 2** INT (U.S.A.) or ■■■ (Canada)  
Intermittent operation
- 3** ON (U.S.A.) or — (Canada)  
Normal operation

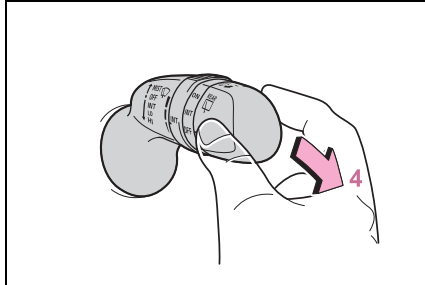

**4**  Washer/wiper dual operation

Pushing the lever operates the wiper and washer. The wiper will automatically operate a couple of times after the washer squirts. The washer will automatically operate and clean the camera for the Digital Rearview Mirror<sup>\*1</sup> (→P.157) and rear camera<sup>\*2</sup>.

\*1: If equipped

\*2: Refer to “NAVIGATION AND MULTIMEDIA SYSTEM OWNER’S MANUAL”.

■ **The rear window wiper and washer can be operated when**

The engine switch is in ON.

■ **If no washer fluid sprays**

Check that the washer nozzle is not blocked if there is washer fluid in the washer fluid tank.

■ **Reverse-linked rear window wiper function**

When the shift lever is shifted to R when the front wipers are operating, the rear window wiper will operate once.

■ **Customization**

Setting of the reverse-linked function can be changed. (→P.515)

 NOTICE

■ **When the washer fluid tank is empty**

Do not operate the switch continually as the washer fluid pump may overheat.



**Opening the fuel tank cap**

**Perform the following steps to open the fuel tank cap:**

**Before refueling the vehicle**

- Close all the doors and windows, and turn the engine switch off.
- Confirm the type of fuel.

■ **Fuel types**

→P.503

■ **Fuel tank opening for unleaded gasoline**

To help prevent incorrect fueling, your vehicle has a fuel tank opening that only accommodates the special nozzle on unleaded fuel pumps.

■ **If the malfunction indicator lamp illuminates**

The malfunction indicator lamp may illuminate erroneously if refueling is performed repeatedly when the fuel tank is nearly full.

 **WARNING**

■ **When refueling the vehicle**

Observe the following precautions while refueling the vehicle. Failure to do so may result in death or serious injury.

● After exiting the vehicle and before opening the fuel door, touch an unpainted metal surface to discharge any static electricity. It is important to discharge static electricity before refueling because sparks resulting from static electricity can cause fuel vapors to ignite while refueling.

● Always hold the grips on the fuel tank cap and turn it slowly to remove it. A whooshing sound may be heard when the fuel tank cap is loosened. Wait until the sound cannot be heard before fully removing the cap. In hot weather, pressurized fuel may spray out of the filler neck and cause injury.

● Do not allow anyone that has not discharged static electricity from their body to come close to an open fuel tank.

● Do not inhale vaporized fuel. Fuel contains substances that are harmful if inhaled.

● Do not smoke while refueling the vehicle. Doing so may cause the fuel to ignite and cause a fire.

● Do not return to the vehicle or touch any person or object that is statically charged. This may cause static electricity to build up, resulting in a possible ignition hazard.

■ **When refueling**

Observe the following precautions to prevent fuel overflowing from the fuel tank:

● Securely insert the fuel nozzle into the fuel filler neck.

● Stop filling the tank after the fuel nozzle automatically clicks off.

**⚠ WARNING**

- Do not top off the fuel tank.

**⚠ NOTICE**

■ **Refueling**

Do not spill fuel during refueling. Doing so may damage the vehicle, such as causing the emission control system to operate abnormally or damaging fuel system components or the vehicle's painted surface.

**Opening the fuel tank cap**

- 1 Press the switch to open the fuel filler door.

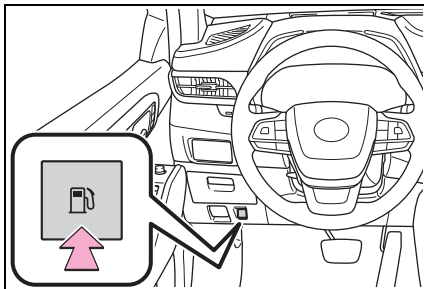

- 2 Turn the fuel tank cap slowly to remove it and hang it on the back of the fuel filler door.

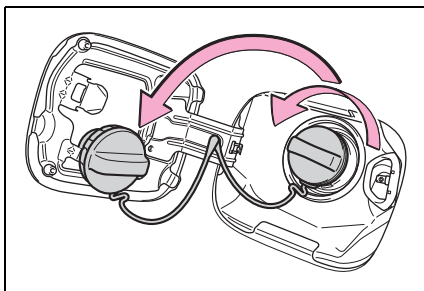

■ **If the fuel filler door cannot be opened**

→P.480

**Closing the fuel tank cap**

After refueling, turn the fuel tank cap until you hear a click. Once the cap is released, it will turn slightly in the opposite direction.

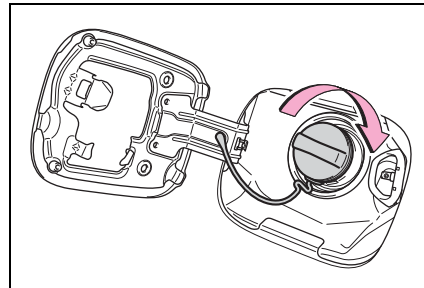

**⚠ WARNING**

■ **When replacing the fuel tank cap**

Do not use anything but a genuine Toyota fuel tank cap designed for your vehicle. Doing so may cause a fire or other incident which may result in death or serious injury.

**Toyota Safety Sense 2.0**

The Toyota Safety Sense 2.0 consists of the following drive assist systems and contributes to a safe and comfortable driving experience:

**Driving assist system**

- **PCS (Pre-Collision System)**  
→P.233
- **LTA (Lane Tracing Assist)**  
→P.241
- **AHB (Automatic High Beam)**  
→P.217
- **RSA (Road Sign Assist)\***  
→P.251
- \*: If equipped
- **Dynamic radar cruise control with full-speed range**  
→P.254

**! WARNING**

■ **Toyota Safety Sense 2.0**

The Toyota Safety Sense 2.0 is designed to operate under the assumption that the driver will drive safely, and is designed to help reduce the impact to the occupants and the vehicle in the case of a collision or assist the driver in normal driving conditions.

As there is a limit to the degree of recognition accuracy and control performance that this system can provide, do not overly rely on this system. The driver is always responsible for paying attention to the vehicle's surroundings and driving safely.

**Sensors**

Two types of sensors, located behind the front grille and windshield, detect information necessary to operate the drive assist systems.

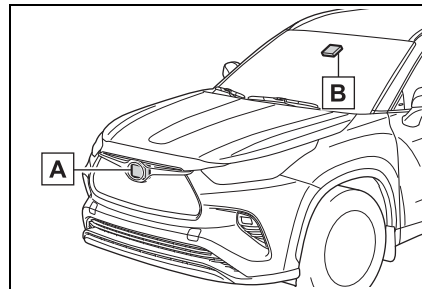

- A** Radar sensor
- B** Front camera

**⚠ WARNING**

■ **To avoid malfunction of the radar sensor**

Observe the following precautions.

Otherwise, the radar sensor may not operate properly, possibly leading to an accident resulting in death or serious injury.

- Keep the radar sensor and the radar sensor cover clean at all times.

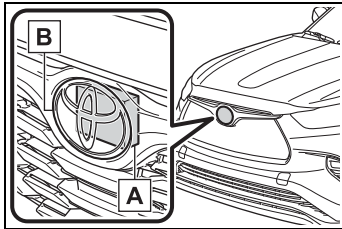

- A** Radar sensor
- B** Radar sensor cover

If the front of the radar sensor or the front or back of the radar sensor cover is dirty or covered with water droplets, snow, etc., clean it.

Clean the radar sensor and radar sensor cover with a soft cloth to avoid damaging them.

- Do not attach accessories, stickers (including transparent stickers) or other items to the radar sensor, radar sensor cover or surrounding area.
- Do not subject the radar sensor or its surrounding area to a strong impact.  
If the radar sensor, front grille, or front bumper has been subjected to a strong impact, have the vehicle inspected by your Toyota dealer.

- Do not disassemble the radar sensor.
- Do not modify or paint the radar sensor or radar sensor cover.
- In the following cases, the radar sensor must be recalibrated. Contact your Toyota dealer for details.
  - When the radar sensor or front grille are removed and installed, or replaced
  - When the front bumper is replaced

■ **To avoid malfunction of the front camera**

Observe the following precautions.

Otherwise, the front camera may not operate properly, possibly leading to an accident resulting in death or serious injury.

- Keep the windshield clean at all times.
  - If the windshield is dirty or covered with an oily film, water droplets, snow, etc., clean the windshield.
  - If a glass coating agent is applied to the windshield, it will still be necessary to use the windshield wipers to remove water droplets, etc. from the area of the windshield in front of the front camera.
  - If the inner side of the windshield where the front camera is installed is dirty, contact your Toyota dealer.

**⚠ WARNING**

- Do not attach objects, such as stickers, transparent stickers, etc., to the outer side of the windshield in front of the front camera (shaded area in the illustration).

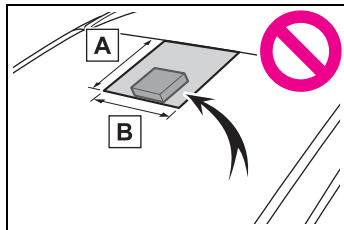

**A** From the top of the windshield to approximately 0.4 in. (1 cm) below the bottom of the front camera

**B** Approximately 7.9 in. (20 cm) (Approximately 4.0 in. [10 cm] to the right and left from the center of the front camera)

- If the part of the windshield in front of the front camera is fogged up or covered with condensation, or ice, use the windshield defogger to remove the fog, condensation, or ice. (→P.329, 335)
- If water droplets cannot be properly removed from the area of the windshield in front of the front camera by the windshield wipers, replace the wiper insert or wiper blade.
- Do not attach window tint to the windshield.
- Replace the windshield if it is damaged or cracked. After replacing the windshield, the front camera must be recalibrated. Contact your Toyota dealer for details.

- Do not allow liquids to contact the front camera.
- Do not allow bright lights to shine into the front camera.
- Do not dirty or damage the front camera. When cleaning the inside of the windshield, do not allow glass cleaner to contact the lens of the front camera. Also, do not touch the lens. If the lens is dirty or damaged, contact your Toyota dealer.
- Do not subject the front camera to a strong impact.
- Do not change the installation position or direction of the front camera or remove it.
- Do not disassemble the front camera.
- Do not modify any components of the vehicle around the front camera (inside rear view mirror, etc.) or ceiling.
- Do not attach any accessories to the hood, front grille or front bumper that may obstruct the front camera. Contact your Toyota dealer for details.
- If a surfboard or other long object is to be mounted on the roof, make sure that it will not obstruct the front camera.
- Do not modify the headlights or other lights.

■ **Certification**

- ▶ Except for vehicles sold in Canada

FCC ID: HYQDNMWR009

**NOTE:**

This device complies with part 15 of the FCC Rules. Operation is subject to the following two conditions: (1) This device may not cause harmful interference, and (2) this device must accept any interference received, including interference that may cause undesired operation.

**FCC WARNING:**

Changes or modifications not expressly approved by the party responsible for compliance could void the user's authority to operate the equipment.

**Radiofrequency radiation exposure Information:**

This equipment complies with FCC radiation exposure limits set forth for an uncontrolled environment. This equipment should be installed and operated with minimum distance of 20 cm between the radiator (antenna) and your body. This transmitter must not be co-located or operating in conjunction with any other antenna or transmitter.

- ▶ For vehicles sold in Canada

**NOTE:**

This device contains licence-exempt transmitter(s)/receiver(s) that comply with Innovation, Science and Economic Development Canada's licence-exempt RSS(s). Operation is subject to the following two conditions:

- (1) This device may not cause interference.
- (2) This device must accept any interference, including interference that may cause undesired operation of the device.

This equipment complies with IC radiation exposure limits set forth for an uncontrolled environment and meets RSS-102 of the IC radio frequency (RF) Exposure rules. This equipment should be installed and operated keeping the radiator at least 20 cm or more away from person's body.

**NOTE:**

L'émetteur/récepteur exempt de licence contenu dans le présent appareil est conforme aux CNR d'Innovation, Sciences et Développement économique Canada applicables aux appareils radio exempts de licence. L'exploitation est autorisée aux deux conditions suivantes :

- 1) L'appareil ne doit pas produire de brouillage;
- 2) L'appareil doit accepter tout brouillage radioélectrique subi, même si le brouillage est susceptible d'en compromettre le fonctionnement.

Cet équipement est conforme aux limites d'exposition aux rayonnements énoncées pour un environnement non contrôlé et respecte les règles d'exposition aux fréquences radioélectriques (RF) CNR-102 de l'IC. Cet équipement doit être installé et utilisé en gardant une distance de 20 cm ou plus entre le dispositif rayonnant et le corps.

**■ If a warning message is displayed on the multi-information display**

A system may be temporarily unavailable or there may be a malfunction in the system.

- In the following situations, perform the actions specified in the table. When the normal operating conditions are detected, the message will disappear and the system will become operational.

If the message does not disappear, contact your Toyota dealer.

Situation	Actions
When the area around a sensor is covered with dirt, moisture (fogged up, covered with condensation, ice, etc.), or other foreign matter	To clean the part of the windshield in front of the front camera , use the windshield wipers or the windshield defogger of the air conditioning system (→P.329, 335).

**232** 4-5. Using the driving support systems

Situation	Actions
<p>When the temperature around the front camera is outside of the operational range, such as when the vehicle is in the sun or in an extremely cold environment</p>	<p>If the front camera is hot, such as after the vehicle had been parked in the sun, use the air conditioning system to decrease the temperature around the front camera.</p> <p>If a sunshade was used when the vehicle was parked, depending on its type, the sunlight reflected from the surface of the sunshade may cause the temperature of the front camera to become excessively high.</p>
	<p>If the front camera is cold, such after the vehicle is parked in an extremely cold environment, use the air conditioning system to increase the temperature around the front camera.</p>
<p>The area in front of the front camera is obstructed, such as when the hood is open or a sticker is attached to the part of the windshield in front of the front camera.</p>	<p>Close the hood, remove the sticker, etc. to clear the obstruction.</p>

- In the following situations, if the situation has changed (or the vehicle has been driven for some time) and the normal operating conditions are detected, the message will disappear and the system will become operational.  
If the message does not disappear, contact your Toyota dealer.
- When the temperature around the radar sensor is outside of the operational range, such as when the vehicle is in the sun or in an extremely cold environment
- When the front camera cannot detect objects in front of the vehicle, such as when driving in the dark, snow, or fog, or when bright lights are shining into the front camera



## PCS (Pre-Collision System)

The pre-collision system uses a radar sensor and front camera to detect objects (→P.233) in front of the vehicle. When the system determines that the possibility of a frontal collision with an object is high, a warning operates to urge the driver to take evasive action and the potential brake pressure is increased to help the driver avoid the collision. If the system determines that the possibility of a frontal collision with an object is extremely high, the brakes are automatically applied to help avoid the collision or help reduce the impact of the collision.

The pre-collision system can be disabled/enabled and the warning timing can be changed. (→P.235)

## Detectable objects

The system can detect the following:

- Vehicles
- Bicyclists
- Pedestrians

## System functions

### ■ Pre-collision warning

When the system determines that the possibility of a frontal collision is high, a buzzer will sound and a warning message will be displayed on the multi-information display to urge the driver to take evasive action.

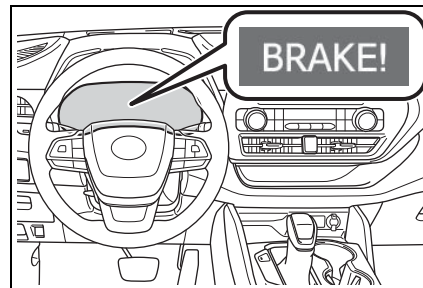

### ■ Pre-collision brake assist

When the system determines that the possibility of a frontal collision is high, the system applies greater braking force in relation to how strongly the brake pedal is depressed.

### ■ Pre-collision braking

If the system determines that the possibility of a frontal collision is extremely high, the brakes are automatically applied to help avoid the collision or reduce the impact of the collision.

**⚠ WARNING****■ Limitations of the pre-collision system**

- The driver is solely responsible for safe driving. Always drive safely, taking care to observe your surroundings. Do not use the pre-collision system instead of normal braking operations under any circumstances. This system will not prevent collisions or lessen collision damage or injury in every situation. Do not overly rely on this system. Failure to do so may lead to an accident, resulting in death or serious injury.
- Although this system is designed to help avoid a collision or help reduce the impact of the collision, its effectiveness may change according to various conditions, therefore the system may not always be able to achieve the same level of performance. Read the following conditions carefully. Do not overly rely on this system and always drive carefully.
- Conditions under which the system may operate even if there is no possibility of a collision: →P.237
- Conditions under which the system may not operate properly: →P.238
- Do not attempt to test the operation of the pre-collision system yourself. Depending on the objects used for testing (dummies, cardboard objects imitating detectable objects, etc.), the system may not operate properly, possibly leading to an accident.

**■ Pre-collision braking**

- When the pre-collision braking function is operating, a large amount of braking force will be applied.
- If the vehicle is stopped by the operation of the pre-collision braking function, the pre-collision braking function operation will be canceled after approximately 2 seconds. Depress the brake pedal as necessary.
- The pre-collision braking function may not operate if certain operations are performed by the driver. If the accelerator pedal is being depressed strongly or the steering wheel is being turned, the system may determine that the driver is taking evasive action and possibly prevent the pre-collision braking function from operating.
- In some situations, while the pre-collision braking function is operating, operation of the function may be canceled if the accelerator pedal is depressed strongly or the steering wheel is turned and the system determines that the driver is taking evasive action.
- If the brake pedal is being depressed, the system may determine that the driver is taking evasive action and possibly delay the operation timing of the pre-collision braking function.

**■ When to disable the pre-collision system**

In the following situations, disable the system, as it may not operate properly, possibly leading to an accident resulting in death or serious injury:

- When the vehicle is being towed

**⚠ WARNING**

- When your vehicle is towing another vehicle
- When transporting the vehicle via truck, boat, train or similar means of transportation
- When the vehicle is raised on a lift with the engine running and the tires are allowed to rotate freely
- When inspecting the vehicle using a drum tester such as a chassis dynamometer or speedometer tester, or when using an on vehicle wheel balancer
- When a strong impact is applied to the front bumper or front grille, due to an accident or other reasons
- If the vehicle cannot be driven in a stable manner, such as when the vehicle has been in an accident or is malfunctioning
- When the vehicle is driven in a sporty manner or off-road
- When the tires are not properly inflated
- When the tires are very worn
- When tires of a size other than specified are installed
- When tire chains are installed
- When a compact spare tire or an emergency tire puncture repair kit is used
- If equipment (snow plow, etc.) that may obstruct the radar sensor or front camera is temporarily installed to the vehicle

**Changing settings of the pre-collision system**

■ **Enabling/disabling the pre-collision system**

The pre-collision system can be enabled/disabled on  (→P.87, 96) of the multi-information display.

The system is automatically enabled each time the engine switch is turned to ON.

If the system is disabled, the PCS warning light will turn on and a message will be displayed on the multi-information display.

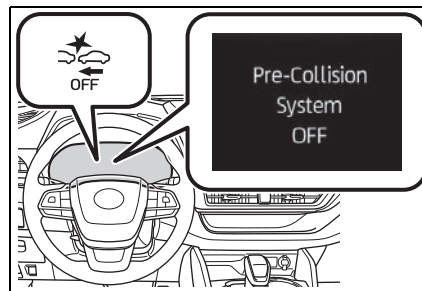

■ **Changing the pre-collision warning timing**

The pre-collision warning timing can be changed on  (→P.87, 96) of the multi-information display.

The warning timing setting is retained when the engine switch is turned OFF. However, if the pre-collision system is disabled and re-enabled, the operation timing will return to the default setting (middle).

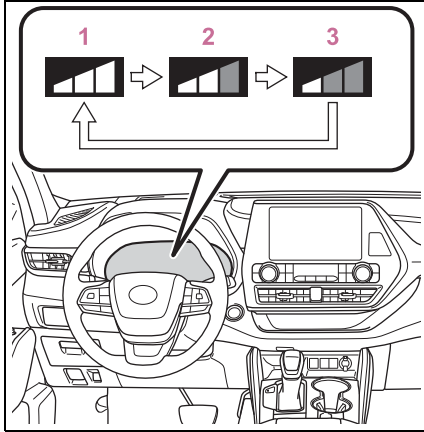

- 2** Middle  
This is the default setting.
- 3** Late

**1** Early

**Operational conditions**

The pre-collision system is enabled and the system determines that the possibility of a frontal collision with a detected object is high. Each function is operational at the following speed

● Pre-collision warning

Detectable objects	Vehicle speed	Relative speed between your vehicle and object
Vehicles	Approx. 7 to 110 mph (10 to 180 km/h)	Approx. 7 to 110 mph (10 to 180 km/h)
Bicyclists and pedestrians	Approx. 7 to 50 mph (10 to 80 km/h)	Approx. 7 to 50 mph (10 to 80 km/h)

● Pre-collision brake assist

Detectable objects	Vehicle speed	Relative speed between your vehicle and object
Vehicles	Approx. 20 to 110 mph (30 to 180 km/h)	Approx. 20 to 110 mph (30 to 180 km/h)
Bicyclists and pedestrians	Approx. 20 to 50 mph (30 to 80 km/h)	Approx. 20 to 50 mph (30 to 80 km/h)

● Pre-collision braking

Detectable objects	Vehicle speed	Relative speed between your vehicle and object
Vehicles	Approx. 7 to 110 mph (10 to 180 km/h)	Approx. 7 to 110 mph (10 to 180 km/h)
Bicyclists and pedestrians	Approx. 7 to 50 mph (10 to 80 km/h)	Approx. 7 to 50 mph (10 to 80 km/h)

The system may not operate in the following situations:

- If a battery terminal has been disconnected and reconnected and then the vehicle has not been driven for a certain amount of time
- If the shift lever is in R
- When the VSC OFF indicator is illuminated (only the pre-collision warning function will be operational)

■ **Object detection function**

The system detects objects based on their size, profile, motion, etc. However, an object may not be detected depending on the surrounding brightness and the motion, posture, and angle of the detected object, preventing the system from operating properly. (→P.238)  
The illustration shows an image of detectable objects.

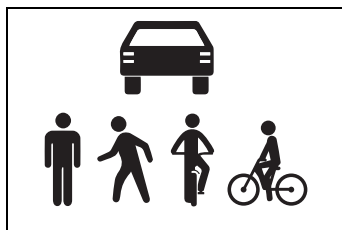

■ **Cancellation of the pre-collision braking**

If either of the following occur while the pre-collision braking function is operating, it will be canceled:

- The accelerator pedal is depressed strongly.
- The steering wheel is turned sharply or abruptly.

■ **Conditions under which the system may operate even if there is no possibility of a collision**

- In some situations such as the following, the system may determine that there is a possibility of a frontal collision and operate.
- When passing a detectable object, etc.
- When changing lanes while overtaking a detectable object, etc.
- When approaching a detectable object in an adjacent lane or on the roadside, such as when changing the course of travel or driving on a winding road

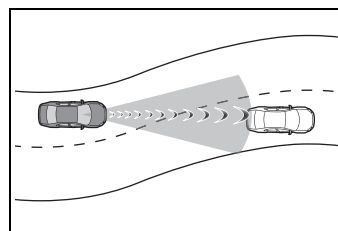

- When rapidly closing on a detectable object, etc.
- When approaching objects on the roadside, such as detectable objects, guardrails, utility poles, trees, or walls
- When there is a detectable object or other object by the roadside at the entrance of a curve

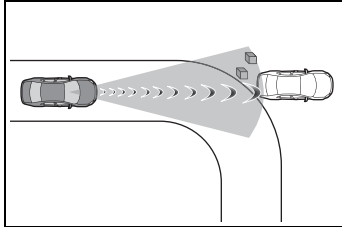

- When there are patterns or paint in front of your vehicle that may be mistaken for a detectable object
- When the front of your vehicle is hit by water, snow, dust, etc.
- When overtaking a detectable object that is changing lanes or making a right/left turn

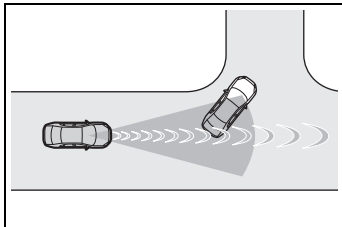

- When passing a detectable object in an oncoming lane that is stopped to make a right/left turn

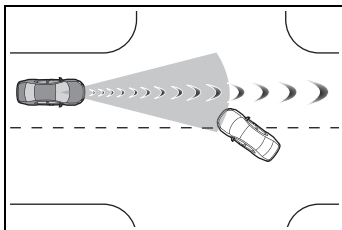

- When a detectable object approaches very close and then stops before entering the path of your vehicle
- If the front of your vehicle is raised or lowered, such as when on an uneven or undulating road surface
- When driving on a road surrounded by a structure, such as in a tunnel or on an iron bridge
- When there is a metal object (manhole cover, steel plate, etc.), steps, or a protrusion in front of your vehicle
- When passing under an object

(road sign, billboard, etc.)

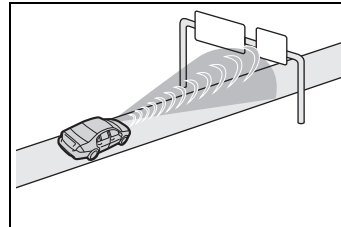

- When approaching an electric toll gate barrier, parking area barrier, or other barrier that opens and closes
- When using an automatic car wash
- When driving through or under objects that may contact your vehicle, such as thick grass, tree branches, or a banner

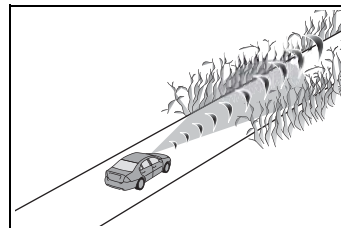

- When driving through steam or smoke
- When driving near an object that reflects radio waves, such as a large truck or guardrail
- When driving near a TV tower, broadcasting station, electric power plant, or other location where strong radio waves or electrical noise may be present

■ **Situations in which the system may not operate properly**

- In some situations such as the following, an object may not be detected by the radar sensor and front camera, preventing the system from operating properly:
  - When a detectable object is approaching your vehicle
  - When your vehicle or a detectable object is wobbling
  - If a detectable object makes an abrupt maneuver (such as sudden

swerving, acceleration or deceleration)

- When your vehicle approaches a detectable object rapidly
- When a detectable object is not directly in front of your vehicle

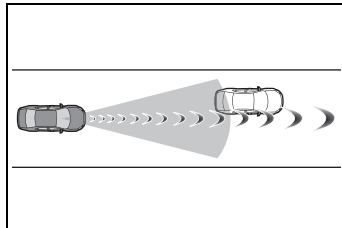

- When a detectable object is near a wall, fence, guardrail, manhole cover, vehicle, steel plate on the road, etc.
- When a detectable object is under a structure
- When part of a detectable object is hidden by an object, such as large baggage, an umbrella, or guardrail
- When multiple detectable objects are close together
- If the sun or other light is shining directly on a detectable object
- When a detectable object is a shade of white and looks extremely bright
- When a detectable object appears to be nearly the same color or brightness as its surroundings
- If a detectable object cuts or suddenly emerges in front of your vehicle
- When the front of your vehicle is hit by water, snow, dust, etc.
- When a very bright light ahead, such as the sun or the headlights of oncoming traffic, shines directly into the front camera
- When approaching the side or front of a vehicle ahead
- If a vehicle ahead is a motorcycle
- If a vehicle ahead is narrow, such as a personal mobility vehicle
- If a preceding vehicle has a small rear end, such as an unloaded truck
- If a preceding vehicle has a low

rear end, such as a low bed trailer

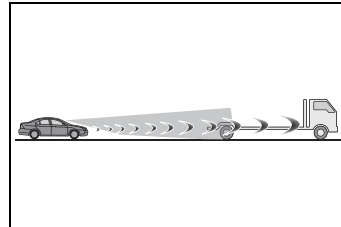

- If a vehicle ahead has extremely high ground clearance

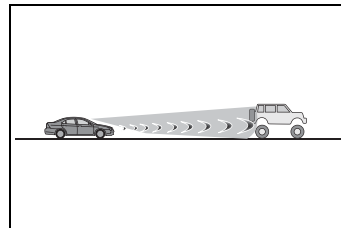

- If a vehicle ahead is carrying a load which protrudes past its rear bumper
- If a vehicle ahead is irregularly shaped, such as a tractor or side car
- If a vehicle ahead is a child sized bicycle, a bicycle that is carrying a large load, a bicycle ridden by more than one person, or a uniquely shaped bicycle (bicycle with a child seat, tandem bicycle, etc.)
- If a pedestrian/or the riding height of a bicyclist ahead is shorter than approximately 3.2 ft. (1 m) or taller than approximately 6.5 ft. (2 m)
- If a pedestrian/bicyclist is wearing oversized clothing (a rain coat, long skirt, etc.), making their silhouette obscure
- If a pedestrian is bending forward or squatting or bicyclist is bending forward
- If a pedestrian/bicyclist is moving fast
- If a pedestrian is pushing a stroller, wheelchair, bicycle or other vehicle
- When driving in inclement weather such as heavy rain, fog, snow or a sandstorm

## 240 4-5. Using the driving support systems

- When driving through steam or smoke
- When the surrounding area is dim, such as at dawn or dusk, or while at night or in a tunnel, making a detectable object appear to be nearly the same color as its surroundings
- When driving in a place where the surrounding brightness changes suddenly, such as at the entrance or exit of a tunnel
- After the engine has started the vehicle has not been driven for a certain amount of time
- While making a left/right turn and for a few seconds after making a left/right turn
- While driving on a curve and for a few seconds after driving on a curve
- If your vehicle is skidding
- If the front of the vehicle is raised or lowered

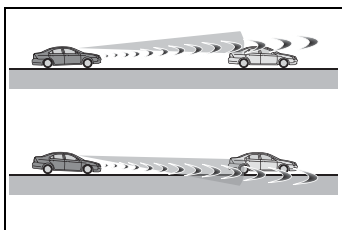

- If the wheels are misaligned
- If a wiper blade is blocking the front camera
- The vehicle is being driven at extremely high speeds
- When driving on a hill
- If the radar sensor or front camera is misaligned
- In some situations such as the following, sufficient braking force may not be obtained, preventing the system from performing properly:
  - If the braking functions cannot operate to their full extent, such as when the brake parts are extremely cold, extremely hot, or wet
  - If the vehicle is not properly maintained (brakes or tires are exces-

sively worn, improper tire inflation pressure, etc.)

- When the vehicle is being driven on a gravel road or other slippery surface

### ■ If VSC is disabled

- If VSC is disabled (→P.315), the pre-collision brake assist and pre-collision braking functions are also disabled.
- The PCS warning light will turn on and “VSC Turned OFF Pre-Collision Brake System Unavailable” will be displayed on the multi-information display.



**LTA (Lane Tracing Assist)**

**When driving on highways and freeways with white (yellow) lane lines, this function alerts the driver when the vehicle might depart from its lane or course\* and provides assistance by operating the steering wheel to keep the vehicle in its lane or course\*. Furthermore, the system provides steering assistance when dynamic radar cruise control with full-speed range is operating to keep the vehicle in its lane.**

**The LTA system recognizes white (yellow) lane lines or a course\* using the front camera. Additionally, it detects preceding vehicles using the front camera and radar.**

\*: Boundary between asphalt and the side of the road, such as grass, soil, or a curb

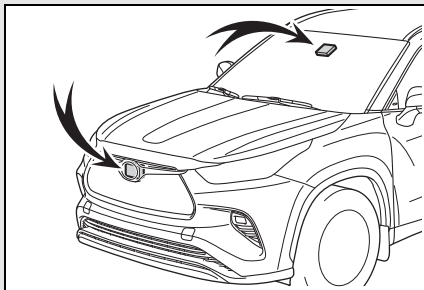

**⚠ WARNING**

**■ Before using LTA system**

● Do not rely solely upon the LTA system. The LTA system does not automatically drive the vehicle or reduce the amount of attention that must be paid to the area in front of the vehicle. The driver must always assume full responsibility for driving safely by paying careful attention to the surrounding conditions and operating the steering wheel to correct the path of the vehicle. Also, the driver must take adequate breaks when fatigued, such as from driving for a long period of time.

● Failure to perform appropriate driving operations and pay careful attention may lead to an accident, resulting in death or serious injury.

● When not using the LTA system, use the LTA switch to turn the system off.

**■ Situations unsuitable for LTA system**

In the following situations, use the LTA switch to turn the system off. Failure to do so may lead to an accident, resulting in death or serious injury.

● Vehicle is driven on a road surface which is slippery due to rainy weather, fallen snow, freezing, etc.

● Vehicle is driven on a snow-covered road.

● White (yellow) lines are difficult to see due to rain, snow, fog, dust, etc.

● Vehicle is driven in a temporary lane or restricted lane due to construction work.

**⚠ WARNING**

- Vehicle is driven in a construction zone.
- A spare tire, tire chains, etc. are equipped.
- When the tires have been excessively worn, or when the tire inflation pressure is low.
- When tires of a size other than specified are installed.
- Vehicle is driven in traffic lanes other than that highways and freeways.
- When your vehicle is towing a trailer or during emergency towing.

■ **Preventing LTA system malfunctions and operations performed by mistake**

- Do not modify the headlights or place stickers, etc. on the surface of the lights.
- Do not modify the suspension etc. If the suspension etc. needs to be replaced, contact your Toyota dealer.
- Do not install or place anything on the hood or grille. Also, do not install a grille guard (bull bars, kangaroo bar, etc.).
- If your windshield needs repairs, contact your Toyota dealer.

■ **Conditions in which functions may not operate properly**

In the following situations, the functions may not operate properly and the vehicle may depart from its lane. Drive safely by always paying careful attention to your surroundings and operate the steering wheel to correct the path of the vehicle without relying solely on the functions.

- When the follow-up cruising display is displayed (→P.246) and the preceding vehicle changes lanes. (Your vehicle may follow the preceding vehicle and also change lanes.)

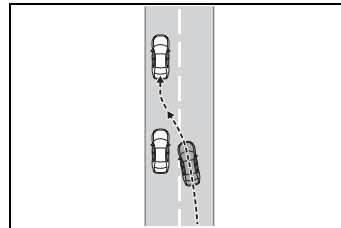

- When the follow-up cruising display is displayed (→P.246) and the preceding vehicle is swaying. (Your vehicle may sway accordingly and depart from the lane.)
- When the follow-up cruising display is displayed (→P.246) and the preceding vehicle departs from its lane. (Your vehicle may follow the preceding vehicle and depart from the lane.)
- When the follow-up cruising display is displayed (→P.246) and the preceding vehicle is being driven extremely close to the left/right lane line. (Your vehicle may follow the preceding vehicle and depart from the lane.)
- Vehicle is being driven around a sharp curve.

**! WARNING**

- Objects or patterns that could be mistaken for white (yellow) lines are present on the side of the road (guardrails, reflective poles, etc.).

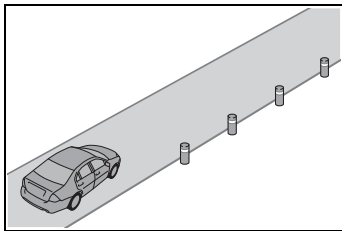

- Vehicle is driven where the road diverges, merges, etc.

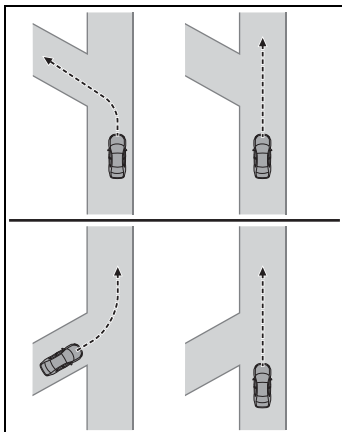

- Repair marks of asphalt, white (yellow) lines, etc. are present due to road repair.

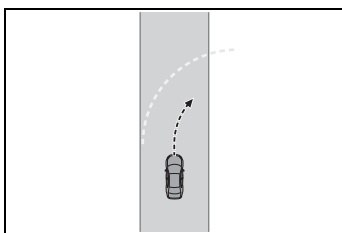

- There are shadows on the road that run parallel with, or cover, the white (yellow) lines.

- The vehicle is driven in an area without white (yellow) lines, such as in front of a tollgate or checkpoint, or at an intersection, etc.
- The white (yellow) lines are cracked, "Botts' dots", "Raised pavement marker" or stones are present.
- The white (yellow) lines cannot be seen or are difficult to see due to sand, etc.
- The vehicle is driven on a road surface that is wet due to rain, puddles, etc.
- The traffic lines are yellow (which may be more difficult to recognize than lines that are white).
- The white (yellow) lines cross over a curb, etc.
- The vehicle is driven on a bright surface, such as concrete.
- If the edge of the road is not clear or straight.
- The vehicle is driven on a surface that is bright due to reflected light, etc.
- The vehicle is driven in an area where the brightness changes suddenly, such as at the entrances and exits of tunnels, etc.
- Light from the headlights of an oncoming vehicle, the sun, etc. enters the camera.
- The vehicle is driven on a slope.
- The vehicle is driven on a road which tilts left or right, or a winding road.
- The vehicle is driven on an unpaved or rough road.

**⚠ WARNING**

- The traffic lane is excessively narrow or wide.
- The vehicle is extremely tilted due to carrying heavy luggage or having improper tire pressure.
- The distance to the preceding vehicle is extremely short.
- The vehicle is moving up and down a large amount due to road conditions during driving (poor roads or road seams).
- When driving in a tunnel or at night with the headlights off or when a headlight is dim due to its lens being dirty or it being misaligned.
- The vehicle is struck by a crosswind.
- The vehicle is affected by wind from a vehicle driven in a nearby lane.
- The vehicle has just changed lanes or crossed an intersection.
- Tires which differ by structure, manufacturer, brand or tread pattern are used.
- Snow tires, etc. are equipped.
- The vehicle is being driven at extremely high speeds.

**Functions included in LTA system**

■ **Lane departure alert function**

When the system determines that the vehicle might depart from its lane or course\*, a warn-

ing is displayed on the multi-information display, and a warning buzzer will sound to alert the driver.

When the warning buzzer sounds, check the area around your vehicle and carefully operate the steering wheel to move the vehicle back to the center of the lane.

Vehicle with BSM: When the system determines that the vehicle might depart from its lane and that the possibility of a collision with an overtaking vehicle in the adjacent lane is high, the lane departure alert will operate even if the turn signals are operating.

\*: Boundary between asphalt and the side of the road, such as grass, soil, or a curb

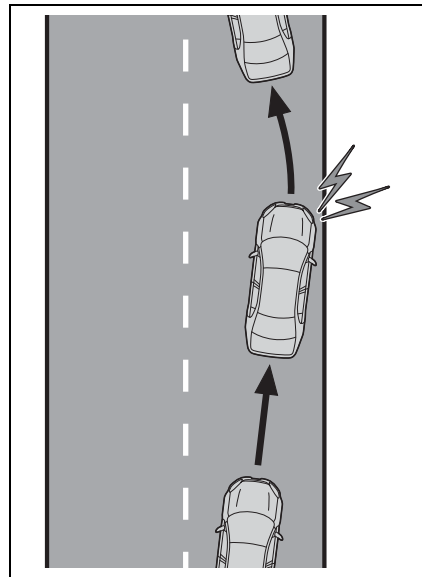

■ **Steering assist function**

When the system determines that the vehicle might depart from its lane or course\*, the sys-

tem provides assistance as necessary by operating the steering wheel in small amounts for a short period of time to keep the vehicle in its lane.

If the system detects that the steering wheel has not been operated for a fixed amount of time or the steering wheel is not being firmly gripped, a warning is displayed on the multi-information display and the function is temporarily canceled.

Vehicle with BSM: When the system determines that the vehicle might depart from its lane and that the possibility of a collision with an overtaking vehicle in the adjacent lane is high, the steering assist function will operate even if the turn signals are operating.

\*: Boundary between asphalt and the side of the road, such as grass, soil, or a curb

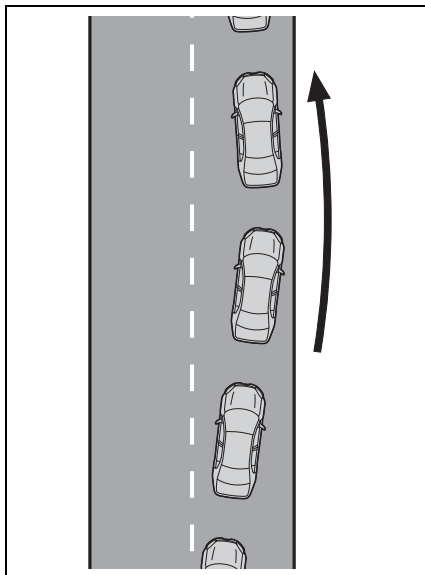

■ **Vehicle sway warning function**

When the vehicle is swaying within a lane, the warning buzzer will sound and a message will be displayed on the multi-information display to alert the driver.

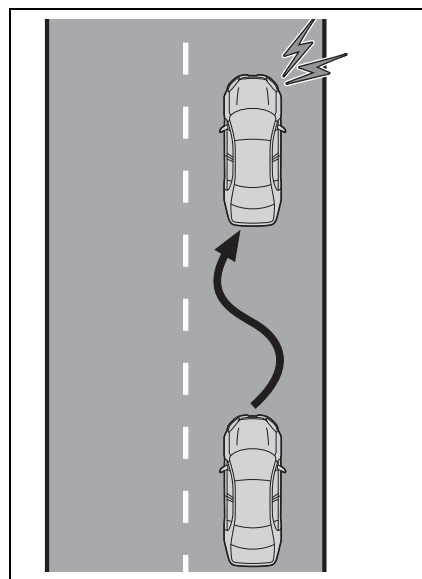

■ **Lane centering function**

This function is linked with dynamic radar cruise control with full-speed range and provides the required assistance by operating the steering wheel to keep the vehicle in its current lane.

When dynamic radar cruise control with full-speed range is not operating, the lane centering function does not operate.

In situations where the white (yellow) lane lines are difficult to see or are not visible, such as when in a

traffic jam, this function will operate to help follow a preceding vehicle by monitoring the position of the preceding vehicle.

If the system detects that the steering wheel has not been operated for a fixed amount of time or the steering wheel is not being firmly gripped, a warning is displayed on the multi-information display and the function is temporarily canceled.

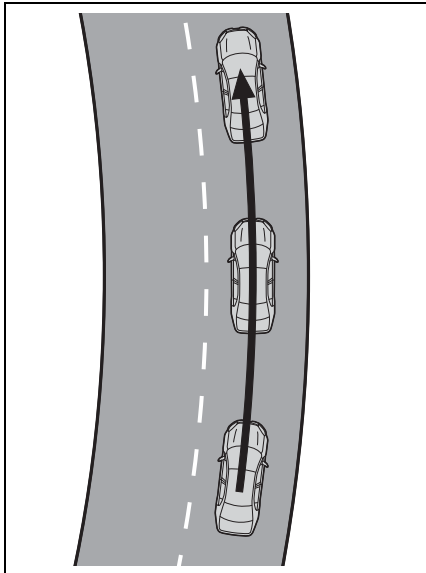

**Turning LTA system on**

Press the LTA switch to turn the LTA system on.

The LTA indicator illuminates and a message is displayed on the multi-information display.

Press the LTA switch again to turn the LTA system off.

When the LTA system is turned on or off, operation of the LTA system continues in the same condition the

next time the engine is started.

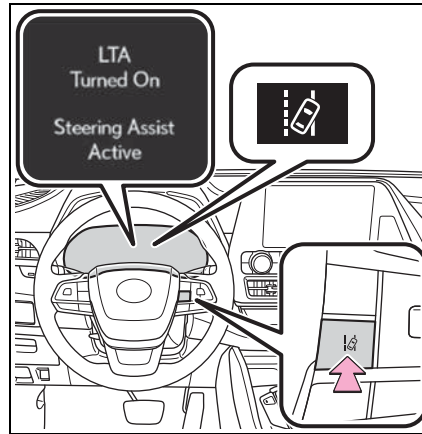

**Indications on multi-information display**

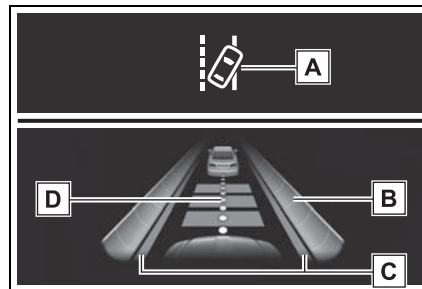

**A** LTA indicator

The illumination condition of the indicator informs the driver of the system operation status.

Illuminated in white: LTA system is operating.

Illuminated in green: Steering wheel assistance of the steering assist function or lane centering function is operating.

Flashing in orange: Lane departure alert function is operating.

**B** Operation display of steering wheel operation support

Displayed when the multi-informa-

tion display is switched to the driving assist system information display.

Indicates that steering wheel assistance of the steering assist function or lane centering function is operating.

Both outer sides of the lane are displayed: Indicates that steering wheel assist of the lane centering function is operating.

One outer side of the lane is displayed: Indicates that steering wheel assist of the steering assist function is operating.

Both outer sides of the lane are flashing: Alerts the driver that their input is necessary to stay in the center of the lane (lane centering function).

**C** Lane departure alert function display

Displayed when the multi-information display is switched to the driving assist system information display.

- ▶ Inside of displayed lines is white

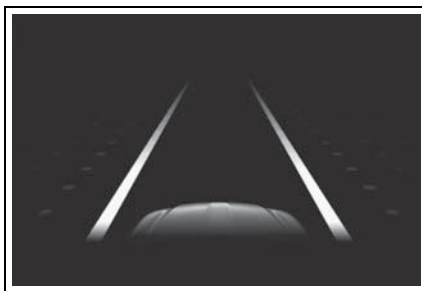

Indicates that the system is recognizing white (yellow) lines or a course\*. When the vehicle departs from its lane, the white

line displayed on the side the vehicle departs from flashes orange.

- ▶ Inside of displayed lines is black

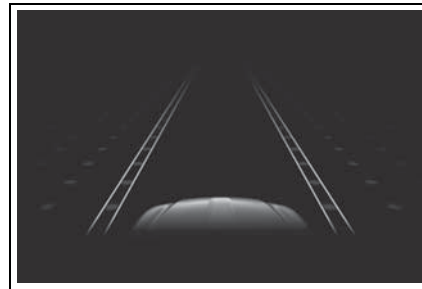

Indicates that the system is not able to recognize white (yellow) lines or a course\* or is temporarily canceled.

\*: Boundary between asphalt and the side of the road, such as grass, soil, or a curb

**D** Follow-up cruising display

Displayed when the multi-information display is switched to the driving assist system information display.

Indicates that steering assist of the lane centering function is operating by monitoring the position of a preceding vehicle.

When the follow-up cruising display is displayed, if the preceding vehicle moves, your vehicle may move in the same way. Always pay careful attention to your surroundings and operate the steering wheel as necessary to correct the path of the vehicle and ensure safety.

■ **Operation conditions of each function**

● **Lane departure alert function**

This function operates when all of the following conditions are met.

- LTA is turned on.
- Vehicle speed is approximately 32 mph (50 km/h) or more.\*<sup>1</sup>
- System recognizes white (yellow) lane lines or a course\*<sup>2</sup>. (When a white [yellow] line or course\*<sup>2</sup> is recognized on only one side, the system will operate only for the recognized side.)
- Width of traffic lane is approximately 9.8 ft. (3 m) or more.
- Turn signal lever is not operated. (Vehicle with BSM: Except when another vehicle is in the lane on the side where the turn signal was operated)
- Vehicle is not being driven around a sharp curve.
- No system malfunctions are detected. (→P.250)

\*<sup>1</sup>: The function operates even if the vehicle speed is less than approximately 32 mph (50 km/h) when the lane centering function is operating.

\*<sup>2</sup>: Boundary between asphalt and the side of the road, such as grass, soil, or a curb

● **Steering assist function**

This function operates when all of the following conditions are met in addition to the operation conditions for the lane departure alert function.

- Setting for “Steering Assist” in  of the multi-information display is set to “ON”. (→P.87, 96)
- Vehicle is not accelerated or decelerated by a fixed amount or more.
- Steering wheel is not operated with a steering force level suitable for changing lanes.
- ABS, VSC, TRAC and PCS are

not operating.

- TRAC or VSC is not turned off.
- Hands off steering wheel warning is not displayed. (→P.249)

● **Vehicle sway warning function**

This function operates when all of the following conditions are met.

- Setting for “Sway Warning” in  of the multi-information display is set to “ON”. (→P.87, 96)
- Vehicle speed is approximately 32 mph (50 km/h) or more.
- Width of traffic lane is approximately 9.8 ft. (3 m) or more.
- No system malfunctions are detected. (→P.250)

● **Lane centering function**

This function operates when all of the following conditions are met.

- LTA is turned on.
- Setting for “Steering Assist” and “Lane Center” in  of the multi-information display are set to “ON”. (→P.87, 96)
- This function recognizes white (yellow) lane lines or the position of a preceding vehicle (except when the preceding vehicle is small, such as a motorcycle).
- The dynamic radar cruise control with full-speed range is operating in vehicle-to-vehicle distance control mode.
- Width of traffic lane is approximately 10 to 13 ft. (3 to 4 m).
- Turn signal lever is not operated.
- Vehicle is not being driven around a sharp curve.
- No system malfunctions are detected. (→P.250)
- Vehicle does not accelerate or decelerate by a fixed amount or more.
- Steering wheel is not operated with a steering force level suitable for changing lanes.
- ABS, VSC, TRAC and PCS are not operating.
- TRAC or VSC is not turned off.
- Hands off steering wheel warning is not displayed. (→P.249)



- The vehicle is being driven in the center of a lane.
- Steering assist function is not operating.

■ **Temporary cancelation of functions**

- When operation conditions are no longer met, a function may be temporarily canceled. However, when the operation conditions are met again, operation of the function is automatically restored. (→P.248)
- If the operation conditions (→P.248) are no longer met while the lane centering function is operating, the buzzer may sound to indicate that the function has been temporarily canceled.

■ **Steering assist function/lane centering function**

- Depending on the vehicle speed, lane departure situation, road conditions, etc., the driver may not feel the function is operating or the function may not operate at all.
- The steering control of the function is overridden by the driver's steering wheel operation.
- Do not attempt to test the operation of the steering assist function.

■ **Lane departure alert function**

- The warning buzzer may be difficult to hear due to external noise, audio playback, etc.
- If the edge of the course\* is not clear or straight, the lane departure alert function may not operate.
- Vehicle with BSM: It may not be possible for the system to determine if there is a danger of a collision with a vehicle in an adjacent lane.
- Do not attempt to test the operation of the lane departure alert function.

\*: Boundary between asphalt and the side of the road, such as grass, soil, or a curb

■ **Hands off steering wheel warning**

In the following situations, a warning message urging the driver to hold the steering wheel and the symbol shown in the illustration are displayed on the multi-information display to warn the driver. The warning stops when the system determines that the driver holds the steering wheel. Always keep your hands on the steering wheel when using this system, regardless of warnings.



- When the system determines that the driver is driving without holding the steering wheel while the system is operating

If the driver continues to keep their hands off of the steering wheel, the buzzer sounds, the driver is warned and the function is temporarily canceled. This warning also operates in the same way when the driver continuously operates the steering wheel only a small amount.

- When the system determines that the vehicle may not turn and instead depart from its lane while driving around a curve

Depending on the vehicle condition and road conditions, the warning may not operate. Also, if the system determines that the vehicle is driving around a curve, warnings will occur earlier than during straight-lane driving.

- When the system determines that

the driver is driving without holding the steering wheel while the steering wheel assist of the steering assist function is operating.

If the driver continues to keep their hands off of the steering wheel and the steering wheel assist is operating, the buzzer sounds and the driver is warned. Each time the buzzer sounds, the continuing time of the buzzer becomes longer.

■ **Vehicle sway warning function**

When the system determines that the vehicle is swaying while the vehicle sway warning function is operating, a buzzer sounds and a warning message urging the driver to rest and the symbol shown in the illustration are simultaneously displayed on the multi-information display.



Depending on the vehicle and road conditions, the warning may not operate.

■ **Warning message**

If the following warning message is displayed on the multi-information display and the LTA indicator illuminates in orange, follow the appropriate troubleshooting procedure. Also, if a different warning message is displayed, follow the instructions displayed on the screen.

- “LTA Malfunction Visit Your Dealer”

The system may not be operating properly. Have the vehicle inspected by your Toyota dealer.

- “LTA Unavailable”

The system is temporarily canceled due to a malfunction in a sensor other than the front camera. Turn the LTA system off, wait for a little while, and then turn the LTA system back on.

- “LTA Unavailable at Current Speed”

The function cannot be used as the vehicle speed exceeds the LTA operation range. Drive slower.

■ **Customization**

Function settings can be changed. (Customizable features:→P.515)

**RSA (Road Sign Assist)\***

\*: If equipped

The RSA system recognizes specific road signs using the front camera and/or navigation system (when speed limit information is available) to provide information to the driver via the display.

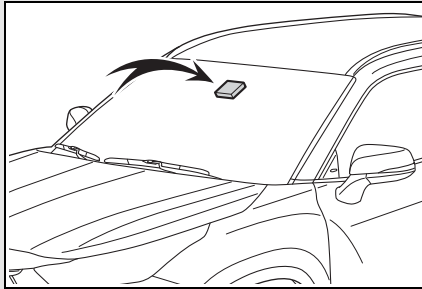

If the system judges that the vehicle is being driven over the speed limit, performing prohibited actions, etc. in relation to the recognized road signs, it notifies the driver using a notification display and notification buzzer.

**⚠ WARNING**

**■ Before using the RSA**

Do not rely solely upon the RSA system. RSA is a system which supports the driver by providing information, but it is not a replacement for a driver's own vision and awareness. Drive safely by always paying careful attention to the traffic rules.

**Indication on the multi-information display**

When the front camera recognizes a sign and/or information of a sign is available from the navigation system, the sign will be displayed on the multi-information display.

- When the driving assist system information is selected, a maximum of 3 signs can be displayed. (→P.82, 91)

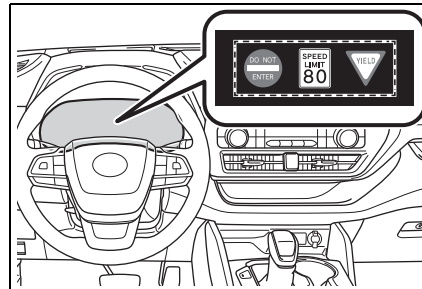

- When a tab other than the driving assist system information is selected, the following types of road signs will be displayed. (→P.82, 91)
  - Speed limit sign
  - Do Not Enter sign (when notification is necessary)

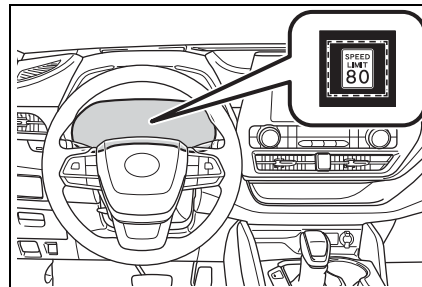

If signs other than speed limit signs

are recognized, they will be displayed in an overlapping stack under the current speed limit sign.

### Supported types of road signs

The following types of road signs, including electronic signs and blinking signs, are recognized.

A non-official or a recently introduced traffic sign may not be recognized.



Speed limit



Do Not Enter



Stop



Yield

### Notification function

In the following situations, the RSA system will notify the driver.



- When the vehicle speed exceeds the speed notification threshold of the speed limit sign displayed, the sign display will be emphasized and a buzzer will sound.
- When the RSA system recognizes a do not enter sign and

determines that your vehicle has entered a no-entry area, the displayed sign will flash and a buzzer will sound.



Depending on the situation, a notification function may not operate properly.

#### Setting procedure

▶ 4.2-inch display

- 1 Press < or > of the meter control switches and select .
- 2 Press ^ or v of the meter control switches and select , then press .

▶ 7-inch display

- 1 Press ^ or v of the meter control switches and select .
- 2 Press < or > of the meter control switches and select , then press .

#### Automatic turn-off of RSA sign display

In the following situations, displayed speed limit and do not enter signs will stop being displayed automatically:

- A new sign is not recognized for a certain distance.
- The road changes due to a left or right turn, etc.

In the following situations, stop and yield signs will stop being displayed automatically:

- The system determines that your vehicle has passed the sign.
- The road changes due to a left or right turn, etc.

■ **Conditions in which the function may not operate or detect correctly**

In the following situations, RSA does not operate normally and may not recognize signs, display the incorrect sign, etc. However, this does not indicate a malfunction.

- The front camera is misaligned due to a strong impact being applied to the sensor, etc.
- Dirt, snow, stickers, etc. are on the windshield near the front camera.
- In inclement weather such as heavy rain, fog, snow or sand storms
- Light from an oncoming vehicle, the sun, etc. enters the front camera.
- The sign is dirty, faded, tilted or bent.
- The contrast of electronic sign is low.
- All or part of the sign is hidden by the leaves of a tree, a pole, etc.
- The sign is only visible to the front camera for a short amount of time.
- The driving scene (turning, lane change, etc.) is judged incorrectly.
- Even if it is a sign not appropriate for the currently traveled lane, such a sign exists directly after a freeway branches, or in an adjacent lane just before merging.
- Stickers are attached to the rear of the preceding vehicle.
- A sign resembling a system compatible sign is recognized.
- Side road speed signs may be detected and displayed (if positioned in sight of the front camera) while the vehicle is traveling on the main road.
- Roundabout exit road speed signs may be detected and displayed (if positioned in sight of the front camera) while traveling on a roundabout.
- The front of the vehicle is raised or lowered due to the carried load
- The surrounding brightness is not sufficient or changes suddenly.
- When a sign intended for trucks, etc. is recognized.
- The speed information displayed on the meter and that displayed on the navigation system may be different due to the navigation system using map data.

■ **Speed limit sign display**

If the engine switch was last turned off while a speed limit sign was displayed on the multi-information display, the same sign displays again when the engine switch is turned to ON.

■ **If “RSA Malfunction Visit Your Dealer” is shown**

The system may be malfunctioning. Have the vehicle inspected by your Toyota dealer.

■ **Customization**

Some functions can be customized. (Customizable features:→P.515)

**Dynamic radar cruise control with full-speed range**

In vehicle-to-vehicle distance control mode, the vehicle automatically accelerates, decelerates and stops to match the speed changes of the preceding vehicle even if the accelerator pedal is not depressed. In constant speed control mode, the vehicle runs at a fixed speed.

Use the dynamic radar cruise control with full-speed range on free-ways and highways.

- Vehicle-to-vehicle distance control mode (→P.257)
- Constant speed control mode (→P.261)

**System Components**

■ Meter display

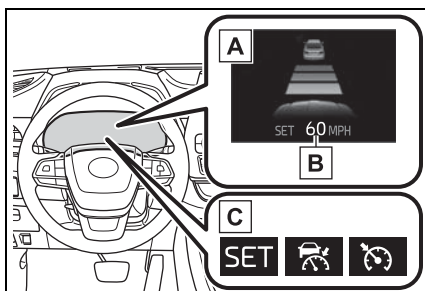

- A Multi-information display
- B Set speed

- C Indicators

■ Operation switches

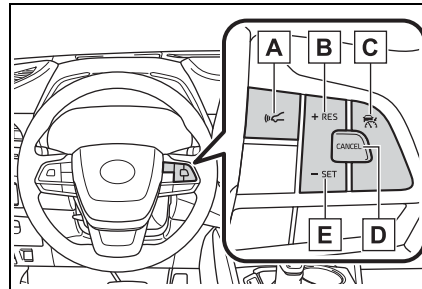

- A Vehicle-to-vehicle distance switch
- B "+RES" switch
- C Cruise control main switch
- D Cancel switch
- E "-SET" switch

**⚠ WARNING**

■ Before using dynamic radar cruise control with full-speed range

- Driving safely is the sole responsibility of the driver. Do not rely solely on the system, and drive safely by always paying careful attention to your surroundings.
- The dynamic radar cruise control with full-speed range provides driving assistance to reduce the driver's burden. However, there are limitations to the assistance provided. Read the following conditions carefully. Do not overly rely on this system and always drive carefully.
  - When the sensor may not be correctly detecting the vehicle ahead: →P.263

**⚠ WARNING**

- Conditions under which the vehicle-to-vehicle distance control mode may not function correctly: →P.263
- Set the speed appropriately depending on the speed limit, traffic flow, road conditions, weather conditions, etc. The driver is responsible for checking the set speed.
- Even when the system is functioning normally, the condition of the preceding vehicle as detected by the system may differ from the condition observed by the driver. Therefore, the driver must always remain alert, assess the danger of each situation and drive safely. Relying solely on this system or assuming the system ensures safety while driving can lead to an accident, resulting in death or serious injury.
- Switch the dynamic radar cruise control with full-speed range setting to off, using the cruise control main switch when not in use.

**■ Cautions regarding the driving assist systems**

Observe the following precautions, as there are limitations to the assistance provided by the system. Failure to do so may cause an accident resulting in death or serious injury.

● Assisting the driver to measure following distance

The dynamic radar cruise control with full-speed range is only intended to help the driver in determining the following distance between the driver's own vehicle and a designated vehicle traveling ahead. It is not a mechanism that allows careless or inattentive driving, and it is not a system that can assist the driver in low-visibility conditions.

It is still necessary for driver to pay close attention to the vehicle's surroundings.

● Assisting the driver to judge proper following distance

The dynamic radar cruise control with full-speed range determines whether the following distance between the driver's own vehicle and a designated vehicle traveling ahead is within a set range. It is not capable of making any other type of judgement. Therefore, it is absolutely necessary for the driver to remain vigilant and to determine whether or not there is a possibility of danger in any given situation.

● Assisting the driver to operate the vehicle

The dynamic radar cruise control with full-speed range does not include functions which will prevent or avoid collisions with vehicles ahead of your vehicle. Therefore, if there is ever any possibility of danger, the driver must take immediate and direct control of the vehicle and act appropriately in order to ensure the safety of all involved.

**WARNING****■ Situations unsuitable for dynamic radar cruise control with full-speed range**

Do not use dynamic radar cruise control with full-speed range in any of the following situations. Doing so may result in inappropriate speed control and could cause an accident resulting in death or serious injury.

- Roads where there are pedestrians, cyclists, etc.
- In heavy traffic
- On roads with sharp bends
- On winding roads
- On slippery roads, such as those covered with rain, ice or snow
- On steep downhill, or where there are sudden changes between sharp up and down gradients  
Vehicle speed may exceed the set speed when driving down a steep hill.
- At entrances to freeways and highways
- When weather conditions are bad enough that they may prevent the sensors from detecting correctly (fog, snow, sandstorm, heavy rain, etc.)
- When there is rain, snow, etc. on the front surface of the radar or front camera
- In traffic conditions that require frequent repeated acceleration and deceleration
- When your vehicle is towing a trailer or during emergency towing

- When an approach warning buzzer is heard often



**Driving in vehicle-to-vehicle distance control mode**

This mode employs a radar to detect the presence of vehicles up to approximately 328 ft. (100 m) ahead, determines the current vehicle-to-vehicle following distance, and operates to maintain a suitable following distance from the vehicle ahead. The desired vehicle-to-vehicle distance can also be set by operating the vehicle-to-vehicle distance switch.

When driving on downhill slopes, the vehicle-to-vehicle distance may become shorter.

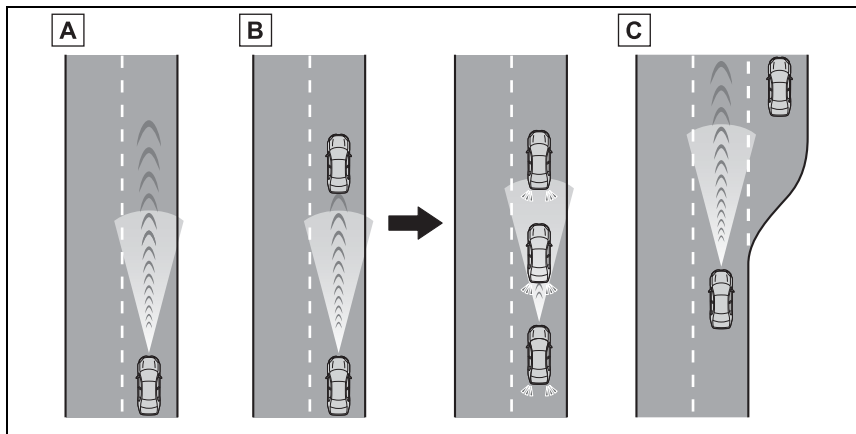

**A** Example of constant speed cruising  
When there are no vehicles ahead

The vehicle travels at the speed set by the driver.

**B** Example of deceleration cruising and follow-up cruising  
When a preceding vehicle driving slower than the set speed appears

When a vehicle is detected running ahead of you, the system automatically decelerates your vehicle. When a greater reduction in vehicle speed is necessary, the system applies the brakes (the stop lights will come on at this time). The system will respond to changes in the speed of the vehicle ahead in order to maintain the vehicle-to-vehicle distance set by the driver. Approach warning warns you when the system cannot decelerate sufficiently to prevent your vehicle from closing in on the vehicle ahead.

When the vehicle ahead of you stops, your vehicle will also stop (vehicle is stopped by system control). After the vehicle ahead starts off, pressing the “+RES” switch or depressing the accelerator pedal (start-off operation) will resume follow-up cruising. If the start-off operation is not performed, system control continues to keep your vehicle stopped.

## 258 4-5. Using the driving support systems

When the turn signal lever is operated and your vehicle moves to a left lane while driving at 50 mph (80 km/h) or more, the vehicle will quickly accelerate to help to overtake a passing vehicle.

### **C** Example of acceleration

When there are no longer any preceding vehicles driving slower than the set speed

The system accelerates until the set speed is reached. The system then returns to constant speed cruising.

### Setting the vehicle speed (vehicle-to-vehicle distance control mode)

- 1 Press the cruise control main switch to activate the cruise control.

Dynamic radar cruise control indicator will come on and a message will be displayed on the multi-information display. Press the switch again to deactivate the cruise control.

If the cruise control main switch is pressed and held for 1.5 seconds or more, the system turns on in constant speed control mode. (→P.261)

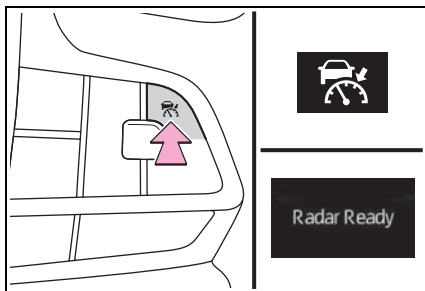

- 2 Accelerate or decelerate, with accelerator pedal operation, to the desired vehicle speed (at or above approximately 20 mph [30 km/h]) and press the “-SET” switch to set the speed.

Cruise control “SET” indicator will come on.

The vehicle speed at the moment the switch is released becomes the set speed.

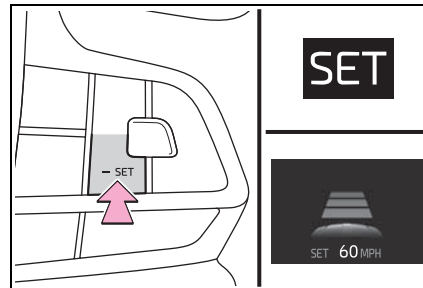

### Adjusting the set speed

- Adjusting the set speed by the switch

To change the set speed, press the “+RES” or “-SET” switch until the desired set speed is displayed.

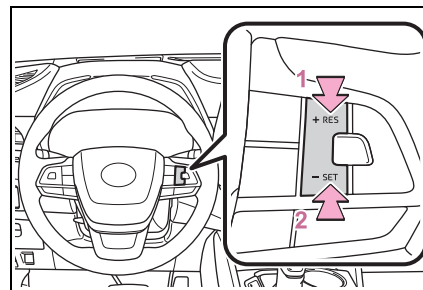

- 1 Increases the speed (Except

when the vehicle has been stopped by system control in vehicle-to-vehicle distance control mode)

**2** Decreases the speed

Fine adjustment: Press the switch.

Large adjustment: Press and hold the switch to change the speed, and release when the desired speed is reached.

In the vehicle-to-vehicle distance control mode, the set speed will be increased or decreased as follows:

- ▶ For the U.S. mainland, Hawaii

Fine adjustment: By 1 mph (1.6 km/h)<sup>\*1</sup> or 1 km/h (0.6 mph)<sup>\*2</sup> each time the switch is pressed

Large adjustment: Increases or decreases in 1 mph (1.6 km/h)<sup>\*1</sup> or 1 km/h (0.6 mph)<sup>\*2</sup> increments for as long as the switch is held

- ▶ For Canada, Guam, Saipan, Puerto Rico and A.Samoa

Fine adjustment: By 1 mph (1.6 km/h)<sup>\*1</sup> or 1 km/h (0.6 mph)<sup>\*2</sup> each time the switch is pressed

Large adjustment: Increases or decreases in 5 mph (8 km/h)<sup>\*1</sup> or 5 km/h (3.1 mph)<sup>\*2</sup> increments for as long as the switch is held

In the constant speed control mode (→P.261), the set speed will be increased or decreased as follows:

Fine adjustment: By 1 mph (1.6 km/h)<sup>\*1</sup> or 1 km/h (0.6 mph)<sup>\*2</sup> each time the switch is pressed

Large adjustment: The speed will continue to change while the switch is held.

\*1: When the set speed is shown in "MPH"

\*2: When the set speed is shown in "km/h"

- Increasing the set speed by the accelerator pedal

- 1 Accelerate with accelerator pedal operation to the desired vehicle speed
- 2 Press the "-SET" switch

**Changing the vehicle-to-vehicle distance (vehicle-to-vehicle distance control mode)**

Pressing the switch changes the vehicle-to-vehicle distance as follows:

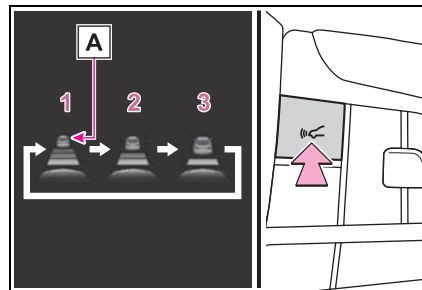

- 1 Long
- 2 Medium
- 3 Short

The vehicle-to-vehicle distance is set automatically to long mode when the engine switch is turned to ON.

If a vehicle is running ahead of you,

the preceding vehicle mark **A** will also be displayed.

**Vehicle-to-vehicle distance settings (vehicle-to-vehicle distance control mode)**

Select a distance from the table below. Note that the distances shown correspond to a vehicle speed of 50 mph (80 km/h). Vehicle-to-vehicle distance increases/decreases in accordance with vehicle speed. When the vehicle is stopped by system control, the vehicle stops at a certain vehicle-to-vehicle distance depending on the situation.

Distance options	Vehicle-to-vehicle distance
Long	Approximately 160 ft. (50 m)
Medium	Approximately 130 ft. (40 m)
Short	Approximately 100 ft. (30 m)

**Resuming follow-up cruising when the vehicle has been stopped by system control (vehicle-to-vehicle distance control mode)**

After the vehicle ahead of you starts off, press the “+RES”

switch.

Your vehicle will also resume follow-up cruising if the accelerator pedal is depressed after the vehicle ahead of you starts off.

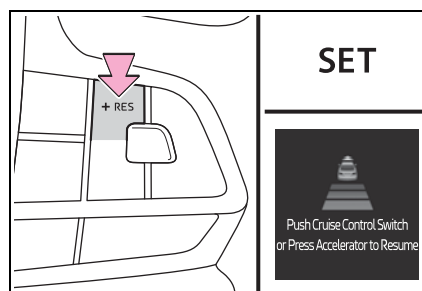

**Canceling and resuming the speed control**

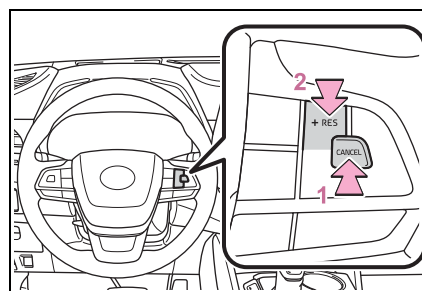

**1** Pressing the cancel switch cancels the speed control.

The speed control is also canceled when the brake pedal is depressed. (When the vehicle has been stopped by system control, depressing the brake pedal does not cancel the setting.)

**2** Pressing the “+RES” switch resumes the cruise control and returns vehicle speed to the set speed.

**Approach warning (vehicle-to-vehicle distance control mode)**

When your vehicle is too close to a vehicle ahead, and sufficient automatic deceleration via the cruise control is not possible, the display will flash and the buzzer will sound to alert the driver. An example of this would be if another driver cuts in front of you while you are following a vehicle. Depress the brake pedal to ensure an appropriate vehicle-to-vehicle distance.

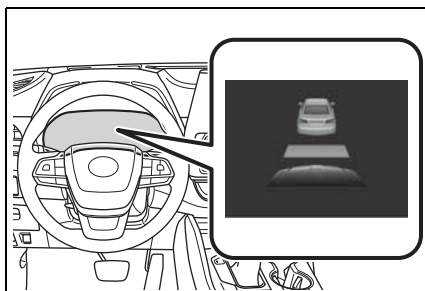

**■ Warnings may not occur when**

In the following instances, warnings may not occur even when the vehicle-to-vehicle distance is small.

- When the speed of the preceding vehicle matches or exceeds your vehicle speed
- When the preceding vehicle is traveling at an extremely slow speed
- Immediately after the cruise control speed was set

- When depressing the accelerator pedal

**Selecting constant speed control mode**

When constant speed control mode is selected, your vehicle will maintain a set speed without controlling the vehicle-to-vehicle distance. Select this mode only when vehicle-to-vehicle distance control mode does not function correctly due to a dirty radar, etc.

- 1 With the cruise control off, press and hold the cruise control main switch for 1.5 seconds or more.

Immediately after the switch is pressed, the dynamic radar cruise control indicator will come on. Afterwards, it switches to the cruise control indicator.

Switching to constant speed control mode is only possible when operating the switch with the cruise control off.

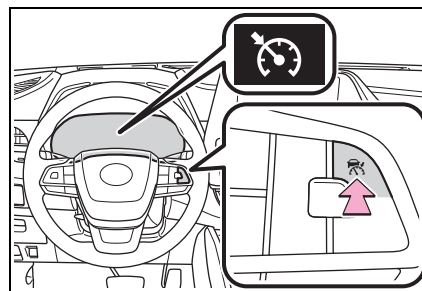

- 2 Accelerate or decelerate, with accelerator pedal operation, to the desired vehicle speed (at or above approximately 20 mph [30 km/h])

and press the “-SET” switch to set the speed.

Cruise control “SET” indicator will come on.

The vehicle speed at the moment the switch is released becomes the set speed.

Adjusting the speed setting:  
→P.258

Canceling and resuming the speed setting: →P.260

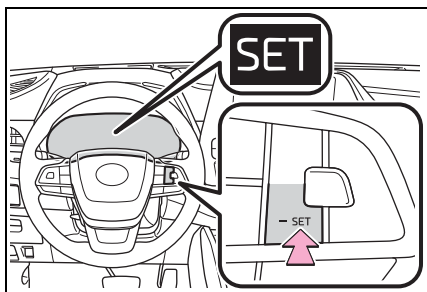

■ **Dynamic radar cruise control with full-speed range can be set when**

- The shift lever is in D.
- The desired set speed can be set when the vehicle speed is approximately 20 mph (30 km/h) or more. (However, when the vehicle speed is set while driving at below approximately 20 mph [30 km/h], the set speed will be set to approximately 20 mph [30 km/h].)

■ **Accelerating after setting the vehicle speed**

The vehicle can accelerate by operating the accelerator pedal. After accelerating, the set speed resumes. However, during vehicle-to-vehicle distance control mode, the vehicle speed may decrease below the set speed in order to maintain the distance to the preceding vehicle.

■ **When the vehicle stops while follow-up cruising**

- Pressing the “+RES” switch while the vehicle ahead stops will resume follow-up cruising if the vehicle ahead starts off within approximately 3 seconds after the switch is pressed.
- If the vehicle ahead starts off within 3 seconds after your vehicle stops, follow-up cruising will be resumed.

■ **Automatic cancelation of vehicle-to-vehicle distance control mode**

Vehicle-to-vehicle distance control mode is automatically canceled in the following situations.

- VSC is activated.
- TRAC is activated for a period of time.
- When the VSC or TRAC system is turned off.
- When snow mode is set.
- The sensor cannot detect correctly because it is covered in some way.
- Pre-collision braking is activated.
- The parking brake is operated.
- The vehicle is stopped by system control on a steep incline.
- The following are detected when the vehicle has been stopped by system control:
  - The driver is not wearing a seat belt.
  - The driver’s door is opened.
  - The vehicle has been stopped for about 3 minutes

If vehicle-to-vehicle distance control mode is automatically canceled for any reasons other than the above, there may be a malfunction in the system. Contact your Toyota dealer.

■ **Automatic cancelation of constant speed control mode**

Constant speed control mode is

automatically canceled in the following situations:

- Actual vehicle speed is more than approximately 10 mph (16 km/h) below the set vehicle speed.
- Actual vehicle speed falls below approximately 20 mph (30 km/h).
- VSC is activated.
- TRAC is activated for a period of time.
- When the VSC or TRAC system is turned off.
- Pre-collision braking is activated.
- The parking brake is operated.

If constant speed control mode is automatically canceled for any reasons other than the above, there may be a malfunction in the system. Contact your Toyota dealer.

■ **Brake operation**

A brake operation sound may be heard and the brake pedal response may change, but these are not malfunctions.

■ **Warning messages and buzzers for dynamic radar cruise control with full-speed range**

Warning messages and buzzers are used to indicate a system malfunction or to inform the driver of the need for caution while driving. If a warning message is shown on the multi-information display, read the message and follow the instructions. (→P.231, 460)

■ **When the sensor may not be correctly detecting the vehicle ahead**

In the case of the following and depending on the conditions, operate the brake pedal when deceleration of the system is insufficient or operate the accelerator pedal when acceleration is required. As the sensor may not be able to correctly detect these types of vehicles, the approach warning (→P.261) may not be activated.

- Vehicles that cut in suddenly
- Vehicles traveling at low speeds
- Vehicles that are not moving in the same lane
- Vehicles with small rear ends (trailers with no load on board, etc.)

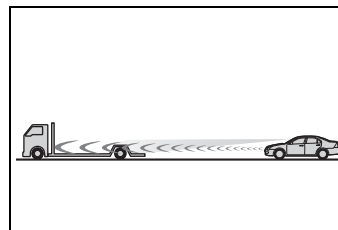

- Motorcycles traveling in the same lane
- When water or snow thrown up by the surrounding vehicles hinders the detecting of the sensor
- When your vehicle is pointing upwards (caused by a heavy load in the luggage compartment, etc.)

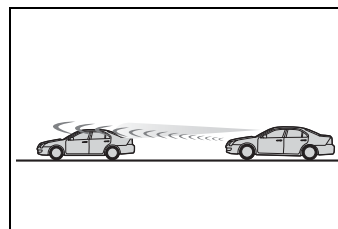

- Preceding vehicle has an extremely high ground clearance

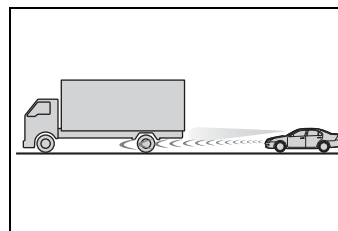

■ **Conditions under which the vehicle-to-vehicle distance control mode may not function correctly**

In the case of the following conditions, operate the brake pedal (or

accelerator pedal, depending on the situation) as necessary. As the sensor may not be able to correctly detect vehicles ahead, the system may not operate properly.

- When the road curves or when the lanes are narrow

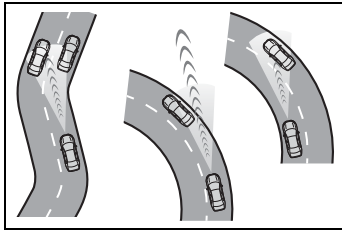

- When steering wheel operation or your position in the lane is unstable

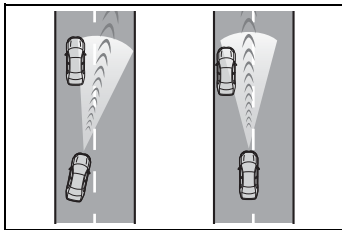

- When the vehicle ahead of you decelerates suddenly
- When driving on a road surrounded by a structure, such as in a tunnel or on a bridge
- While the vehicle speed is decreasing to the set speed after the vehicle accelerates by depressing the accelerator pedal

## Stop & Start system\*

\*: If equipped

**The Stop & Start system stops and starts the engine according to brake pedal or shift lever operation when the vehicle is stopped, such as at a stoplight, intersection, etc., in order to improve fuel economy and reduce noise pollution caused by the engine idling.**

## Stop & Start system operation

### ■ Stopping the engine

While driving with the D shift position selected, depress the brake pedal and stop the vehicle. The engine will stop automatically.

When the engine stops, the Stop & Start indicator will illuminate.

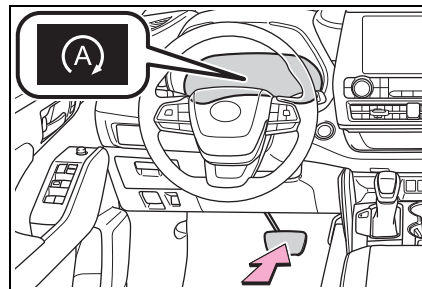

### ■ Restarting the engine

Release the brake pedal. The engine will start automatically.

When the engine starts, the Stop & Start indicator will turn off.



■ **When the brake hold system is operating**

- When the engine is stopped by the Stop & Start system, if the brake pedal is released the engine will remain stopped.
- If the accelerator pedal is depressed while the engine is stopped by the Stop & Start system, the engine will restart.
- While the engine is stopped by the Stop & Start system, if the engine is restarted, the brake hold system will continue to apply the brakes, unless the operation conditions of the brake hold system are no longer met. (→P.212)

■ **When the dynamic radar cruise control with full-speed range is operating**

- When the vehicle is stopped by the dynamic radar cruise control with full-speed range, the engine will stop automatically even though the brake pedal is not depressed.
- When the preceding vehicle starts off, the engine will restart automatically.
- If the engine is restarted by the Stop & Start system while the vehicle is stopped by the dynamic radar cruise control with full-speed range, the

vehicle will remain stopped.

**Disabling the Stop & Start system**

Press the Stop & Start cancel switch to disable the Stop & Start system.

The Stop & Start cancel indicator will illuminate.

Pressing the switch again will enable the Stop & Start system and the Stop & Start cancel indicator will turn off.

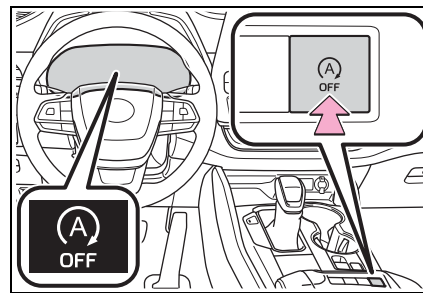

■ **Automatic enabling of the Stop & Start system**

If the Stop & Start system is disabled using the Stop & Start cancel switch, it will be automatically re-enabled once the engine switch is turned off and then the engine is started.

**Hill-start assist control**

When the engine is stopped by the Stop & Start system when the vehicle is on an incline, when the brake pedal is released, brake force is temporarily maintained to prevent the vehicle from rolling backwards before the engine is restarted

and drive force is generated. When drive force is generated, the maintained brake force is automatically canceled.

- This function operates on flat surfaces as well as steep inclines.
- Sound may be generated from the brake system, but this does not indicate a malfunction.
- Brake pedal response may change and vibration may occur, but this does not indicate a malfunction.

---

**■ Points for use**

- If the engine switch is pressed when the engine is stopped by the Stop & Start system, the engine will not be able to be restarted by the automatic engine start function. In this case, restart the engine using the normal engine starting procedure. (→P.200)
- When the engine is being restarted by the Stop & Start system, the power outlets may be temporarily unusable, but this does not indicate a malfunction.
- Installation and removal of electrical components and wireless devices may affect the Stop & Start system. Contact your Toyota dealer for details.
- When stopping the vehicle for a longer period of time, turn the engine switch off to stop the engine completely.
- When the engine is restarted by the Stop & Start system, the steering wheel may temporarily feel heavy.

**■ Operating conditions**

- The Stop & Start system is operational when all of the following conditions are met:
  - The vehicle has been driven a certain amount of time.
  - The brake pedal is being depressed firmly. (Except when the vehicle is stopped by the dynamic radar cruise control with full-speed range when in vehicle-to-vehicle distance control mode)
  - The D shift position is selected.
  - The driver's seat belt is fastened.
  - The driver's door is closed.
  - The selected driving mode is NORMAL or ECO mode.
  - The selected driving mode is not SNOW mode.
  - The windshield defogger is off. (vehicles without a manual air conditioning system)
  - The accelerator pedal is not being depressed.
  - The engine is adequately warmed up.
  - The outside temperature is 23°F (-5°C ) or higher.
  - The hood is closed. (→P.267)
- In the following situations the engine may not be stopped by the Stop & Start system. This is not a malfunction of the Stop & Start system.
  - When the air conditioning system is being used.
  - When the battery is undergoing a periodic recharge.
  - When the battery is not sufficiently charged, such as if the vehicle has been parked for a long time and the battery charge has decreased, the electric load is large, the battery fluid temperature is excessively low or the battery has deteriorated.
  - When the brake booster vacuum is low.
  - When the elapsed time since the engine was restarted is short.
  - When the vehicle is stopped frequently, such as when in a traffic

jam.

- When the engine coolant temperature or transmission fluid temperature is extremely low or high.
- When the vehicle is stopped on a steep incline.
- When the steering wheel is being operated.
- When the vehicle is being driven in a high altitude area.
- When the battery fluid temperature is extremely low or high.
- For a while after the battery terminals have been disconnected and reconnected.
- When the engine is stopped by the Stop & Start system, the engine will be restarted automatically if any of the following conditions are met: (To enable the engine to be stopped by the Stop & Start system again, drive the vehicle.)
  - The air conditioning system is turned on. (vehicles without a manual air conditioning system)
  - The windshield defogger is turned on. (vehicles without a manual air conditioning system)
  - The shift lever is shifted from D or P.
  - The shift lever is shifted from P. (When the engine is stopped by the Stop & Start system when the shift lever is in P.)
  - The driver's seat belt is unfastened.
  - The driver's door is opened.
  - The driving mode is changed from NORMAL or ECO mode to another mode.
  - The driving mode is changed to SNOW mode.
  - The Stop & Start cancel switch is pressed.
  - The steering wheel is operated.
  - The accelerator pedal is depressed.
  - The vehicle starts to roll on an incline.
- When the engine is stopped by the Stop & Start system, the engine may restart automatically

in the following situations: (To enable the engine to be stopped by the Stop & Start system again, drive the vehicle.)

- When the brake pedal is pumped or strongly depressed.
- When the air conditioning system is being used.
- When a switch of the air conditioning system is operated (windshield defogger switch, etc.).
- If the battery charge becomes low.

■ **When the hood is opened**

- If the hood is opened while the engine is stopped by the Stop & Start system, the engine will stall and will not be able to be restarted by the automatic engine start function. In this case, restart the engine using the normal engine starting procedure. (→P.200)
- If the hood is closed after the engine is started with the hood open, the Stop & Start system will not operate. Close the hood, turn the engine switch off, wait 30 seconds or more, and then start the engine.

■ **Air conditioning system operation while the engine is stopped by the Stop & Start system**

Vehicles with an automatic air conditioning system: When the air conditioning is in automatic mode and the engine is stopped by the Stop & Start system, the fan may operate at a low speed in order to prevent the temperature in the cabin from increasing or decreasing or may be stopped.

To prioritize air conditioning system performance when the vehicle is stopped, disable the Stop & Start system by pressing the Stop & Start cancel switch.

- If the windshield is fogged up  
Turn the windshield defogger on.  
(→P.333)

If the windshield fogs up frequently, press the Stop & Start cancel switch

to disable the Stop & Start system.

- If an odor is emitted from the air conditioning system
- Vehicles with a manual air conditioning system

If the idling stop time setting is set to “Extended” change it to “Standard”.

If an odor is emitted when the idling stop time setting is set to “Standard”, press the Stop & Start cancel switch to deactivate the Stop & Start system.

- Vehicles with an automatic air conditioning system

Press the Stop & Start cancel switch to deactivate the Stop & Start system.

■ **Changing the idling stop time with the air conditioning system on**

The length of time the Stop & Start system will operate when the air conditioning system is on can be changed in  of the multi-information display (→P.87, 96). (The length of time the Stop & Start system will operate when the air conditioning system is off cannot be changed.)

■ **Displaying the Stop & Start system status**

→P.87, 96

■ **Multi-information display messages**

If the following situations,  and a message may be displayed on the multi-information display.

- When the engine cannot be stopped by the Stop & Start system

 “Press brake more to activate”

- The brake pedal is not sufficiently depressed.

→ If the brake pedal is depressed further, the system will operate.

 “Non-Dedicated Battery”

- A battery not designed for use with a Stop & Start system may have been installed.

→ Have the vehicle inspected by your Toyota dealer.

 “Battery Charging”

- The battery charge may be low.

→ Stopping of the engine is temporarily prohibited to prioritize charging of the battery. After the engine runs for a certain amount of time, the system will be enabled.

- A refresh charge may be occurring

→ After a refresh charge for up to an hour completes, the system can be operated.

- If displayed continuously for a long time (more than an hour)

→ The battery may be deteriorated. Contact your Toyota dealer for details.

 “Stop & Start system Unavailable”

- The Stop & Start system is temporarily disabled.

→ Allow the engine to run for some time.

- The engine may have been started with the hood open.

→ Close the hood, turn the engine switch off, wait for 30 seconds or more, and then start the engine.

 “In Preparation”

- The vehicle is being driven in a high altitude area.

- The brake booster vacuum is low.

→ When the brake booster vacuum reaches a predetermined level, the system will be enabled.



**“For Climate Control”**

- The air conditioning system is being used when the ambient temperature is high or low.  
→ If the difference between the set temperature and cabin temperature becomes small, the system will be enabled.
- The windshield defogger is on.
- When the engine automatically restarts while stopped by the Stop & Start system



**“In Preparation”**

- The brake pedal has been depressed further or pumped.  
→ The system will be enabled after the engine runs and the brake booster vacuum reaches a predetermined level.



**“For Climate Control”**

- The air conditioning system has been turned on or is being used.
- The windshield defogger has been turned on.



**“Battery Charging”**

- The battery charge may be low.  
→ The system will be enabled after the engine runs to sufficiently charge the battery.

**■ When the buzzer sounds**

If the driver's door is opened when the engine is stopped by the Stop & Start system and the shift lever is in D, a buzzer will sound and the Stop & Start system indicator will flash. To stop the buzzer, close the driver's door.

**■ The Stop & Start system protection function**

- When the volume of the audio system is excessively high, sound output from the audio system may suddenly be cut off in order to

reduce battery consumption. To prevent the audio system from being cut off, keep the volume of audio system at a moderate level. If the audio system has been cut off, turn the engine switch off, wait for 3 seconds or more and then turn it to ACC or ON to re-enable the audio system.

- The audio system may not be activated if the battery terminals are disconnected and then reconnected. If this occurs, turn the engine switch off and then repeat the following operation twice to activate the audio system normally.
- Turn the engine switch to ON and then to OFF.

**■ Replacing the battery**

→P.485

**■ If the Stop & Start cancel indicator flashes continuously**

The system may be malfunctioning. Have the vehicle inspected by your Toyota dealer.

**■ If “Stop & Start System Malfunction Visit Your Dealer” is displayed on the multi-information display**

The system may be malfunctioning. Have the vehicle inspected by your Toyota dealer.



**WARNING**

**■ When the Stop & Start system is operating**

Make sure to disable the Stop & Start system while the vehicle is in a poorly ventilated area. If not disabled, the engine may be automatically restarted unexpectedly, causing exhaust gases to collect and enter the vehicle, possibly resulting in death or a serious health hazard.

 **WARNING**

- Do not leave the vehicle while the engine is stopped by the Stop & Start system (while the Stop & Start indicator is on). An accident may occur due to the automatic engine start function.
- Depress the brake pedal and apply the parking brake when necessary while the engine is stopped by the Stop & Start system (while the Stop & Start indicator is on).

 **NOTICE**

■ **To ensure the system operates correctly**

If any of the following situations occur, the Stop & Start system may not operate correctly. Have your vehicle inspected by your Toyota dealer.

- While the driver's seat belt is fastened, the driver's and front passenger's seat belt reminder light flashes.
- Even though the driver's seat belt is not fastened, the driver's and front passenger's seat belt reminder light does not illuminate.
- Even though the driver's door is closed, the open door warning light is illuminated or the interior light is illuminated when the interior light switch is in the door position.
- Even though the driver's door is open, the open door warning light does not illuminate or the interior light does not illuminate when the interior light switch is in the door position.

**BSM (Blind Spot Monitor)\***

\*: If equipped

**The Blind Spot Monitor is a system that uses rear side radar sensors installed on the inner side of the rear bumper on the left and right side to assist the driver in confirming safety when changing lanes.**

 **WARNING**

■ **Cautions regarding the use of the system**

The driver is solely responsible for safe driving. Always drive safely, taking care to observe your surroundings.

The Blind Spot Monitor is a supplementary function which alerts the driver that a vehicle is in a blind spot of the outside rear view mirrors or is approaching rapidly from behind into a blind spot. Do not overly rely on the Blind Spot Monitor. As the function cannot judge if it is safe to change lanes, over reliance could lead to an accident resulting in death or serious injury.

As the system may not function correctly under certain conditions, the driver's own visual confirmation of safety is necessary.

**System components**

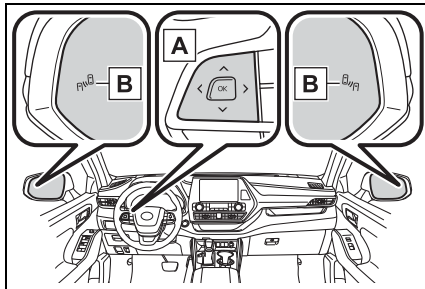

**A** Meter control switches

Turning the Blind Spot Monitor on/off.

When the BSM function is disabled, the BSM OFF indicator illuminates.

**B** Outside rear view mirror indicators

When a vehicle is detected in a blind spot of the outside rear view mirrors or approaching rapidly from behind into a blind spot, the outside rear view mirror indicator on the detected side will illuminate. If the turn signal lever is operated toward the detected side, the outside rear

■ **Certification**

► For vehicles sold in the U.S.A.

FCC ID: HYQDNSRR004

**NOTE:**

This device complies with part 15 of the FCC Rules. Operation is subject to the following two conditions: (1) This device may not cause harmful interference, and (2) this device must accept any interference received, including interference that may cause undesired operation.

**FCC WARNING:**

Changes or modifications not expressly approved by the party responsible for compliance could void the user's authority to operate the equipment.

view mirror indicator flashes.

■ **Outside rear view mirror indicator visibility**

In strong sunlight, the outside rear view mirror indicator may be difficult to see.

■ **When “Blind Spot Monitor Unavailable” is shown on the multi-information display**

Ice, snow, mud, etc., may be attached to the rear bumper around the sensors. (→P.272) The system should return to normal operation after removing the ice, snow, mud, etc. from the rear bumper. Additionally, the sensors may not operate normally when driving in extremely hot or cold environments.

■ **When “Blind Spot Monitor Malfunction Visit Your Dealer” is shown on the multi-information display**

There may be a sensor malfunction of misaligned. Have the vehicle inspected by your Toyota dealer.

■ **Customization**

Some functions can be customized. (→P.515)

## 272 4-5. Using the driving support systems

► For vehicles sold in Canada

**NOTE:**

This device complies with Industry Canada's RSS-310. Operation is subject to the condition that this device must not cause harmful interference and must accept any interference, including interference that may cause undesired operation of the device.

24.05 to 24.25 GHz  
250 mV/m or less @ 3m

**NOTE:**

Le CNR-310 doit être utilisé conjointement avec le CNR-Gen, Exigences générales relatives à la conformité des appareils de radiocommunication, concernant spécifications et informations d'ordre général.

24.05 to 24.25 GHz  
250 mV/m or less @ 3m

**⚠ WARNING**

■ **Handling the rear side radar sensor**

Blind Spot Monitor sensors are installed behind the left and right sides of the rear bumper respectively. Observe the following to ensure the Blind Spot Monitor can operate correctly.

- Keep the sensors and the surrounding areas on the rear bumper clean at all times.

If a sensor or its surrounding area on the rear bumper is dirty or covered with snow, the Blind Spot Monitor may not operate and a warning message (→P.271) will be displayed. In this situation, clear off the dirt or snow and drive the vehicle with the operation conditions of the BSM function (→P.274) satisfied for approximately 10 minutes. If the warning message does not disappear, have the vehicle inspected by your Toyota dealer.

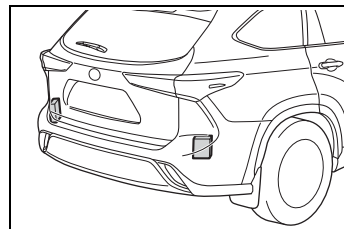





**⚠ WARNING**

- Do not attach stickers to the sensor or surrounding area on the rear bumper.
- Do not subject a sensor or its surrounding area on the rear bumper to a strong impact. If a sensor is moved even slightly off position, the system may malfunction and vehicles may not be detected correctly. In the following situations, have your vehicle inspected by your Toyota dealer.
  - A sensor or its surrounding area is subject to a strong impact.
  - If the surrounding area of a sensor is scratched or dented, or part of them has become disconnected.
- Do not disassemble the sensor.
- Do not modify the sensor or surrounding area on the rear bumper.
- If a sensor or the rear bumper needs to be removed/installed or replaced, contact your Toyota dealer.
- Do not paint the rear bumper any color other than an official Toyota color.



**Turning the Blind Spot Monitor on/off**

Use the meter control switches to turn on/off the function.

▶ 4.2-inch display

- 1 Press < or > of the meter control switches and select .
- 2 Press ^ or v of the meter control switches to select  and then press .

▶ 7-inch display

- 1 Press ^ or v of the meter control switches and select .
- 2 Press < or > of the meter control switches to select  and then press .

**Blind Spot Monitor operation**

■ **Vehicles that can be detected by the Blind Spot Monitor**

The Blind Spot Monitor uses rear side radar sensors to detect the following vehicles traveling in adjacent lanes and advises the driver of the presence of such vehicles via the indicators on the outside rear view mirrors.

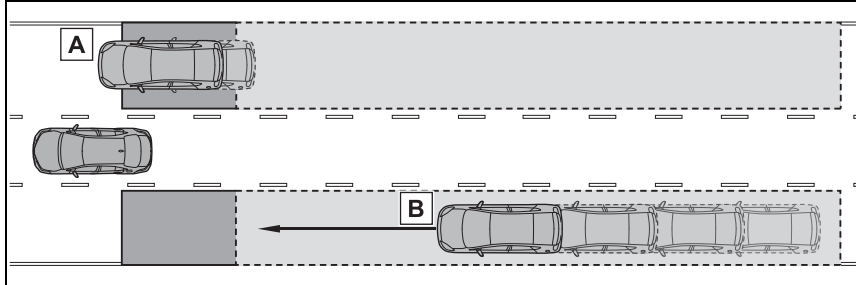

- A** Vehicles that are traveling in areas that are not visible using the outside rear view mirrors (the blind spots)
- B** Vehicles that are approaching rapidly from behind in areas that are not visible using the outside rear view mirrors (the blind spots)

■ **The Blind Spot Monitor detection areas**

The areas that vehicles can be detected in are outlined below.

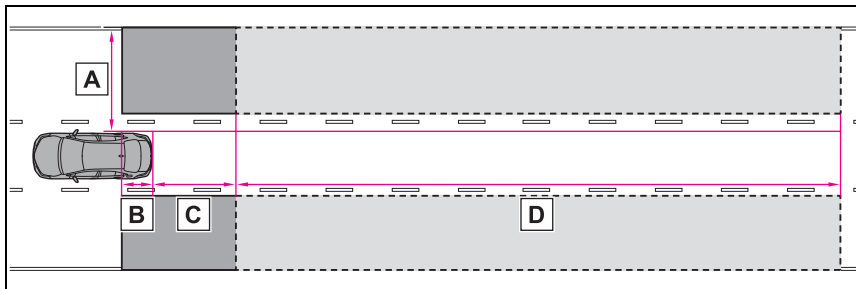

The range of each detection area is:

- A** Approximately 1.6 ft. (0.5 m) to 11.5 ft. (3.5 m) from either side of the vehicle<sup>\*1</sup>
- B** Approximately 3.3 ft. (1 m) forward of the rear bumper
- C** Approximately 9.8 ft. (3 m) from the rear bumper
- D** Approximately 9.8 ft. (3 m) to 197 ft. (60 m) from the rear bumper<sup>\*2</sup>

<sup>\*1</sup>: The area between the side of the vehicle and 1.6 ft. (0.5 m) from the side of the vehicle cannot be detected.

<sup>\*2</sup>: The greater the difference in speed between your vehicle and the detected vehicle is, the farther away the vehicle will be detected, causing the outside rear view mirror indicator to illuminate or flash.

■ **The Blind Spot Monitor is operational when**  
 The Blind Spot Monitor is opera-

tional when all of the following conditions are met:

- The Blind Spot Monitor is on.
- The shift lever is in a position other than R.
- The vehicle speed is greater than approximately 10 mph (16 km/h).

■ **The Blind Spot Monitor will detect a vehicle when**

The Blind Spot Monitor will detect a vehicle present in the detection area in the following situations:

- A vehicle in an adjacent lane overtakes your vehicle.
- You overtake a vehicle in an adjacent lane slowly.
- Another vehicle enters the detection area when it changes lanes.

■ **Conditions under which the Blind Spot Monitor will not detect a vehicle**

The Blind Spot Monitor is not designed to detect the following types of vehicles and/or objects:

- Small motorcycles, bicycles, pedestrians, etc.\*
- Vehicles traveling in the opposite direction
- Guardrails, walls, signs, parked vehicles and similar stationary objects\*
- Following vehicles that are in the same lane\*
- Vehicles traveling 2 lanes away from your vehicle\*
- Vehicles which are being overtaken rapidly by your vehicle\*

\*: Depending on the conditions, detection of a vehicle and/or object may occur.

■ **Conditions under which the Blind Spot Monitor may not function correctly**

- The Blind Spot Monitor may not

detect vehicles correctly in the following situations:

- When the sensor is misaligned due to a strong impact to the sensor or its surrounding area
- When mud, snow, ice, a sticker, etc. is covering the sensor or surrounding area on the rear bumper
- When driving on a road surface that is wet with standing water during bad weather, such as heavy rain, snow, or fog
- When multiple vehicles are approaching with only a small gap between each vehicle
- When the distance between your vehicle and a following vehicle is short
- When there is a significant difference in speed between your vehicle and the vehicle that enters the detection area
- When the difference in speed between your vehicle and another vehicle is changing
- When a vehicle enters a detection area traveling at about the same speed as your vehicle
- As your vehicle starts from a stop, a vehicle remains in the detection area
- When driving up and down consecutive steep inclines, such as hills, dips in the road, etc.
- When driving on roads with sharp bends, consecutive curves, or uneven surfaces
- When vehicle lanes are wide, or when driving on the edge of a lane, and the vehicle in an adjacent lane is far away from your vehicle
- When towing a trailer
- When an accessory (such as a bicycle carrier) is installed to the rear of the vehicle
- When there is a significant difference in height between your vehicle and the vehicle that enters the detection area
- Immediately after the Blind Spot Monitor is turned on
- Instances of the Blind Spot Monitor unnecessarily detecting a vehi-

cle and/or object may increase in the following situations:

- When the sensor is misaligned due to a strong impact to the sensor or its surrounding area
- When the distance between your vehicle and a guardrail, wall, etc. that enters the detection area is short
- When driving up and down consecutive steep inclines, such as hills, dips in the road, etc.
- When vehicle lanes are narrow, or when driving on the edge of a lane, and a vehicle traveling in a lane other than the adjacent lanes enters the detection area
- When driving on roads with sharp bends, consecutive curves, or uneven surfaces
- When the tires are slipping or spinning
- When the distance between your vehicle and a following vehicle is short
- When an accessory (such as a bicycle carrier) is installed to the rear of the vehicle

### Intuitive parking assist\*

\*: If equipped

The distance from your vehicle to objects, such as a wall, when parallel parking or maneuvering into a garage is measured by the sensors and communicated via the multi-information display, head-up display (if equipped), audio system screen and a buzzer. Always check the surrounding area when using this system.

### System components

#### ■ Types of sensors

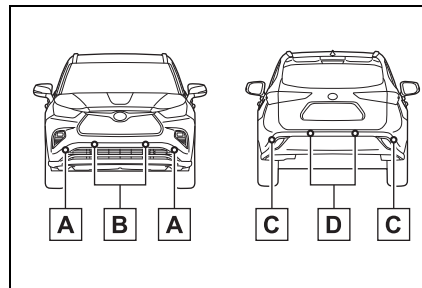

- A** Front corner sensors
- B** Front center sensors
- C** Rear corner sensors
- D** Rear center sensors

#### ■ Display

When the sensors detect an object, such as a wall, a graphic is shown on the multi-information display, head-up display (if

equipped) and audio system screen depending on the position and distance to the object.

- Multi-information display and head-up display

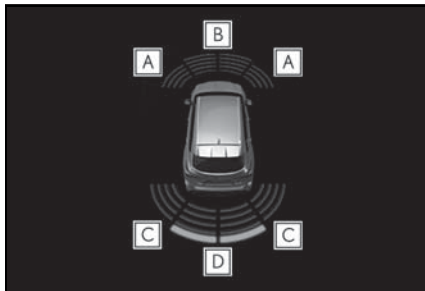

- A** Front corner sensor detection
- B** Front center sensor detection
- C** Rear corner sensor detection
- D** Rear center sensor detection

- Audio system screen (vehicles with a Toyota parking assist monitor)

When the R shift lever is selected, a simplified image is displayed on the audio system screen.

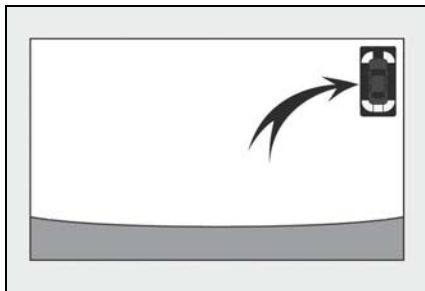

- Audio system screen (vehicles with a Panoramic view monitor)

A graphic will be displayed on the audio system screen.

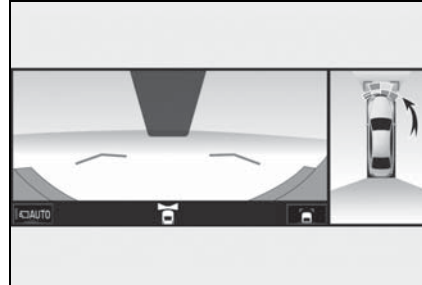

### Turning intuitive parking assist on/off

Use the meter control switches to enable/disable the intuitive parking assist. (→P.96)

- 1 Press  $\wedge$  or  $\vee$  to select .
- 2 Press  $\langle$  or  $\rangle$  to select and then press .

When the intuitive parking assist function is disabled, the intuitive parking assist OFF indicator (→P.76) illuminates.

To re-enable the system, select on the multi-information display, select and turn it on. If the system is disabled, it will remain off even if the engine switch is turned to ON after the engine switch has been turned off.

 **WARNING**

■ **When using the intuitive parking assist**

Observe the following precautions. Failing to do so may result in the vehicle being unable to be driven safely and possibly cause an accident.

- Do not use the sensor at speeds in excess of 6 mph (10 km/h).
- The sensors' detection areas and reaction times are limited. When moving forward or reversing, check the areas surrounding the vehicle (especially the sides of the vehicle) for safety, and drive slowly, using the brake to control the vehicle's speed.
- Do not install accessories within the sensors' detection areas.
- The area directly under the bumpers is not detected. Thin posts or objects lower than the sensor may not be detected when approached, even if they have been detected once.

■ **When to disable the function**

In the following situations, disable the function as it may operate even though there is no possibility of a collision.

- The vehicle is equipped with a fender pole, wireless antenna or fog lights.
- The front or rear bumper or a sensor receives a strong impact.
- A non-genuine Toyota suspension (lowered suspension, etc.) is installed.
- Towing eyelets are installed.

- A backlit licence plate is installed.

■ **When using intuitive parking assist**

In the following situations, the system may not function correctly due to a sensor malfunction, etc. Have the vehicle checked by your Toyota dealer.

- The intuitive parking assist operation display flashes or shows continuously, and a buzzer sounds when no objects are detected.
- If the area around a sensor collides with something, or is subjected to strong impact.
- If the bumper or grille collides with something.
- If the display flashes or is displayed continuously and a buzzer does not sound, except when the mute function has been turned on.
- If a display error occurs, first check the sensor. If the error occurs even when there is no ice, snow or mud on the sensor, it is likely that the sensor is malfunctioning.

■ **Notes when washing the vehicle**

Do not apply intensive bursts of water or steam to the sensor area.

Doing so may result in the sensor malfunctioning.

- When using a high pressure washer to wash the vehicle, do not spray the sensors directly, as doing so may cause a sensor to malfunction.

 **WARNING**

- When using steam to clean the vehicle, do not direct steam too close to the sensors as doing so may cause a sensor to malfunction.

■ **The system can be operated when**

- The engine switch is in ON.
- Intuitive parking assist function is on.
- The vehicle speed is less than about 6 mph (10 km/h).
- A shift lever other than P.

■ **If “Parking Assist Unavailable” is displayed on the multi-information display**

- Water may be continuously flowing over the sensor surface, such as in a heavy rain. When the system determines that it is normal, the system will return to normal.
- Initialization may not have been performed after a battery terminal was disconnected and reconnected. Initialize the system. (→P.279) If this message continues to be displayed even after initialization, have the vehicle inspected by your Toyota dealer.

■ **If “Parking Assist Unavailable Clean Parking Assist Sensor” is displayed on the multi-information display**

A sensor may be covered with ice, snow, dirt, etc. Remove the ice, snow, dirt, etc., from the sensor to return the system to normal.

Also, due to ice forming on a sensor at low temperatures, a warning message may be displayed or the sensor may not be able to detect an object. Once the ice melts, the system will return to normal.

■ **If a battery terminal has been disconnected and reconnected**

The system needs to be initialized. To initialize the system, drive the vehicle straight ahead for 5 seconds or more at a speed of approximately 22 mph (35 km/h) or more.

■ **Sensor detection information**

- The following situations may occur during use.
  - The sensor's detection areas are limited to the areas around the vehicle front and rear bumpers.
  - Depending on the shape of the object and other factors, the detection distance may shorten, or detection may be impossible.
  - If an object is extremely close to a sensor, it may not be detected.
  - There will be a short delay between object detection and display. Even at low speeds, there is a possibility that the object will come within the sensor's detection areas before the display is shown and the warning beep sounds.
  - It might be difficult to hear the buzzer due to the volume of the audio system or air flow noise of the air conditioning system.
  - It may be difficult to hear the buzzer if buzzers for other systems are sounding.

■ **Conditions under which the function may not function correctly**

Certain vehicle conditions and the surrounding environment may affect the ability of a sensor to correctly detect objects. Particular instances where this may occur are listed below.

- There is dirt, snow or ice on a sensor. (Cleaning the sensors will resolve this problem.)
- A sensor is frozen. (Thawing the area will resolve this problem.) In especially cold weather, if a sensor is frozen the sensor display may be displayed abnormally,

or objects, such as a wall, may not be detected.

- A sensor is covered in any way.
- When a sensor or the area around a sensor is extremely hot or cold.
- On an extremely bumpy road, on an incline, on gravel, or on grass.
- The vicinity of the vehicle is noisy due to vehicle horns, motorcycle engines, air brakes of large vehicles, or other loud noises producing ultrasonic waves.
- There is another vehicle equipped with parking assist sensors in the vicinity.
- A sensor is coated with a sheet of spray or heavy rain.
- If a sensor is hit by a large amount of water, such as when driving on a flooded road.
- If the vehicle is significantly tilted.
- The vehicle is approaching a tall or curved curb.
- If objects draw too close to the sensor.

■ **Objects which may not be properly detected**

The shape of the object may prevent the sensor from detecting it. Pay particular attention to the following objects:

- Wires, fences, ropes, etc.
- Cotton, snow and other materials that absorb sound waves
- Sharply-angled objects
- Low objects
- Tall objects with upper sections projecting outwards in the direction of your vehicle

People may not be detected if they are wearing certain types of clothing.

**Setting the buzzer volume**

■ **Adjusting the buzzer volume**

The buzzer volume can be adjusted on the multi-information display.

Use the meter control switches to change settings. (→P.96)

- 1 Press or to select .
- 2 Press or to select and then press and hold .
- 3 Select the volume and then press .

Each time the switch is pressed, the volume level will change between 1, 2, and 3.

■ **Muting a buzzer temporarily**

A mute button will be displayed on the multi-information display when an object is detected. To mute the buzzer, press .

Mute will be canceled automatically in the following situations:

- When the shift lever is changed.
- When the vehicle speed exceeds a certain speed.
- When there is malfunction in a sensor or the system is temporarily unavailable.
- When the operating function is disabled manually.
- When the engine switch is turned off.



**Sensor detection display, object distance**

■ **Detection range of the sensors**

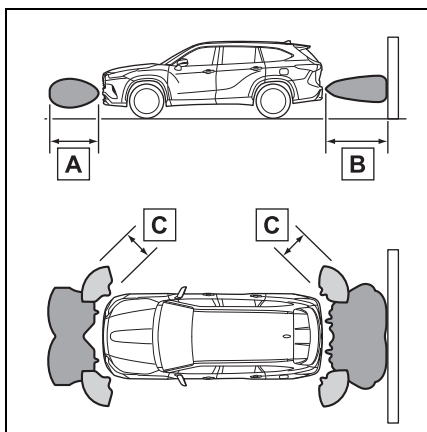



- A** Approximately 3.3 ft. (100 cm)
- B** Approximately 4.9 ft. (150 cm)
- C** Approximately 2.0 ft. (60 cm)

The diagram shows the detection range of the sensors. Note that the sensors cannot detect objects that are extremely close to the vehicle. The range of the sensors may change depending on the shape of the object, etc.

■ **Multi-information display, head-up display (if equipped) and audio system screen**

When an object is detected by a sensor, the approximate distance to the object will be displayed on the multi-information display, audio system screen, and head-up display (if equipped). (As the distance to the object becomes short, the distance segments may blink.)



- Approximate distance to object: 4.9 ft. (150 cm) to 2.0 ft. (60 cm)\* (Rear center sensor)

Multi-information display	Audio system screen	Head-up display
		

\*: Automatic buzzer mute function is enabled. (→P.283)



- Approximate distance to object: 3.3 ft. (100 cm) to 2.0 ft. (60 cm)\* (Front center sensor)

**282** 4-5. Using the driving support systems

Multi-information display	Audio system screen	Head-up display
		



\*: Automatic buzzer mute function is enabled. (→P.283)

- Approximate distance to object: 2.0 ft. (60 cm) to 1.5 ft. (45 cm)\*

Multi-information display	Audio system screen	Head-up display
		



\*: Automatic buzzer mute function is enabled. (→P.283)

- Approximate distance to object: 1.5 ft. (45 cm) to 1.0 ft. (30 cm)\*

Multi-information display	Audio system screen	Head-up display
		

\*: Automatic buzzer mute function is enabled. (→P.283)



- Approximate distance to object: 1.0 ft. (30 cm) to 0.5 ft. (15 cm)\*<sup>1</sup>

Multi-information display* <sup>2</sup>	Audio system screen* <sup>2</sup>	Head-up display
		

\*<sup>1</sup>: Automatic buzzer mute function is disabled. (→P.283)

\*<sup>2</sup>: The distance segments will blink slowly.

- Approximate distance to object: Less than 0.5 ft. (15 cm)\*<sup>1</sup>

Multi-information display*2	Audio system screen*2	Head-up display
		

\*1: Automatic buzzer mute function is disabled. (→P.283)

\*2: The distance segments will blink rapidly.

■ **Buzzer operation and distance to an object**

A buzzer sounds when the sensors are operating.

- The buzzer beeps faster as the vehicle approaches an object. When the vehicle comes within approximately 1.0 ft. (30 cm) of the object, the buzzer sounds continuously.
- When 2 or more objects are detected simultaneously, the buzzer sounds for the nearest object. If one or more objects come within approximately 1.0 ft. (30 cm) of the vehicle, the buzzer will repeat a long tone, followed by fast beeps.
- Automatic buzzer mute function: After a buzzer begins sounding, if the distance between the vehicle and the detected object does not become shorter, the buzzer will be muted automatically. (However, if the distance between the vehicle and object is 1.0 ft. (30 cm) or less, this function will not

operate.)

The buzzer sounds volume can be adjusted. (→P.280)

**RCTA (Rear cross traffic alert) function\***

\*: If equipped

The RCTA function uses the BSM rear side radar sensors installed behind the rear bumper. This function is intended to assist the driver in checking areas that are not easily visible when backing up.

**System components**

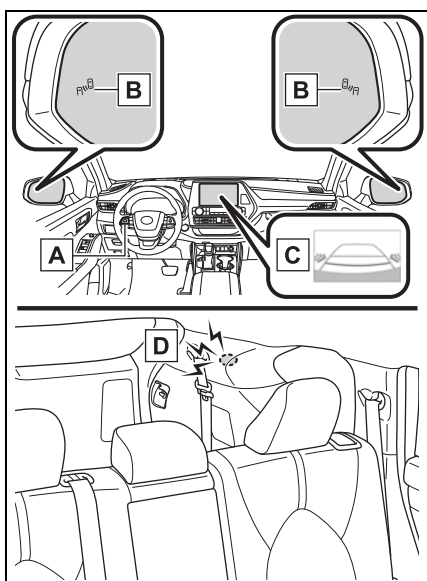

**A** Meter control switches

Turning the RCTA function on/off. When the RCTA function is disabled, the RCTA OFF indicator illuminates.

**B** Outside rear view mirror indicators

When a vehicle approaching from

the right or left at the rear of the vehicle is detected, both outside rear view mirror indicators will flash.

**C** Audio system screen

If a vehicle approaching from the right or left at the rear of the vehicle is detected, the RCTA icon (→P.286) for the detected side will be displayed on the audio system screen. This illustration shows an example of a vehicle approaching from both sides of the vehicle.



**D** RCTA buzzer

If a vehicle approaching from the right or left at the rear of the vehicle is detected, a buzzer will sound.

**Turning the RCTA function on/off**



▶ 4.2-inch display

Use the meter control switches to enable/disable the RCTA function. (→P.87)

- 1 Press < or > to select .
- 2 Press ^ or v to select "RCTA" and then press .

▶ 7-inch display

Use the meter control switches to enable/disable the RCTA function. (→P.96)

- 1 Press ^ or v to select .
- 2 Press < or > to select "RCTA" and then press .

When the RCTA function is disabled, the RCTA OFF indicator (→P.76) illuminates on the

multi-information display. (Each time the engine switch is turned off then changed to ON, the RCTA function will be enabled automatically.)

**⚠ WARNING**

■ **Cautions regarding the use of the function**

The driver is solely responsible for safe driving. Always drive safely, taking care to observe your surroundings.

The RCTA function is only a supplementary function which alerts the driver that a vehicle is approaching from the right or left at the rear of the vehicle. As the RCTA function may not function correctly under certain conditions, the driver's own visual confirmation of safety is necessary. Over reliance on this function may lead to an accident resulting death or serious injury.

**⚠ NOTICE**

■ **Before using the RCTA function**

Do not place objects near the sensors.

■ **Outside rear view mirror indicator visibility**

In strong sunlight, the outside rear view mirror indicator may be difficult to see.

■ **Hearing the RCTA buzzer**

The RCTA buzzer may be difficult to hear over loud noises, such as if the audio system volume is high.

■ **When "Rear Cross Traffic Alert Unavailable" is shown on the multi-information display**

Water, ice, snow, mud, etc., may be attached to the rear bumper around

the sensors. (→P.272) Removing the water, ice, snow, mud, etc., from the attached to the rear bumper around the sensors to return the function to normal.

Additionally, the function may not operate normally when driving in extremely hot or cold environments.

■ **Rear side radar sensors**

→P.272



**Setting the buzzer volume**

■ **Adjusting the buzzer volume**

The buzzer volume can be adjusted on the multi-information display.

▶ **4.2-inch display**



Use the meter control switches to change settings. (→P.87)

- 1 Press < or > to select .
- 2 Press ^ or v to select "RCTA" and then press and hold .
- 3 Select the volume and then press .

Each time the switch is pressed, the volume level will change between 1, 2, and 3.

▶ **7-inch display**

Use the meter control switches to change settings. (→P.96)

- 1 Press ^ or v to select .
- 2 Press < or > to select and "RCTA" then press and hold .

3 Select the volume and then press .

Each time the switch is pressed, the volume level will change between 1, 2, and 3.

■ **Muting a buzzer temporarily**

A mute button will be displayed on the multi-information display when an object is detected. To mute the buzzer, press .

Mute will be canceled automatically in the following situations:

- When the shift lever is changed.
- When the vehicle speed exceeds a certain speed.
- When the operating function is temporarily canceled.
- When the operating function is disabled manually.
- When the engine switch is turned off.

**RCTA function**

■ **Operation of the RCTA function**

The RCTA function uses rear side radar sensors to detect vehicles approaching from the right or left at the rear of the vehicle and alerts the driver of the presence of such vehicles by flashing the outside rear view mirror indicators and sounding a buzzer.

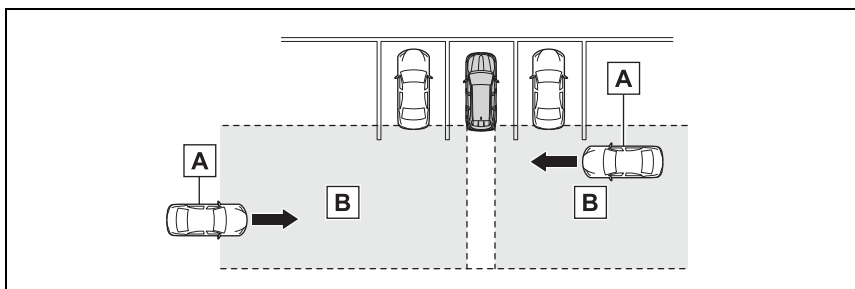

**A** Approaching vehicles

**B** Detection areas of approaching vehicles

■ **RCTA icon display**

When a vehicle approaching from the right or left at the rear of the vehicle is detected, the following will be displayed on the audio system screen.

- Example (Toyota parking

assist monitor) (if equipped):  
Vehicles are approaching from both sides of the vehicle

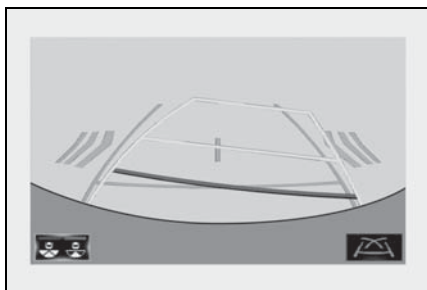

- Example (Panoramic view monitor) (if equipped): Vehi-

cles are approaching from both sides of the vehicle

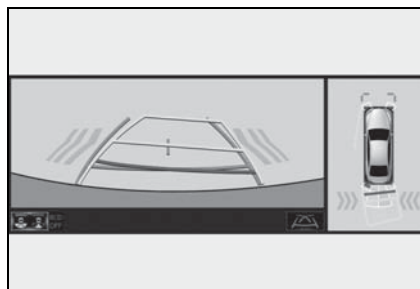

■ **RCTA function detection areas**

The areas that vehicles can be detected in are outlined below.

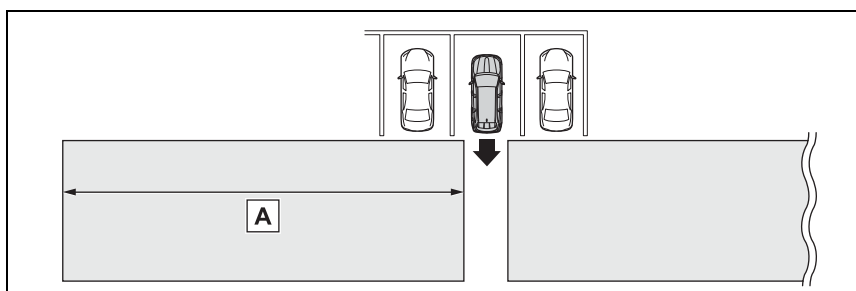

The buzzer can alert the driver of faster vehicles approaching from farther away.

Example:

Approaching vehicle speed	<b>A</b> Approximate alert distance
18 mph (28 km/h) (fast)	65 ft. (20 m)
5 mph (8 km/h) (slow)	18 ft. (5.5 m)

■ **The RCTA function is operational when**

The RCTA function operates when all of the following conditions are met:

- The engine switch is in ON.

- The RCTA function is on.
- The shift lever is in R.
- The vehicle speed is less than approximately 5 mph (8 km/h).
- The approaching vehicle speed is between approximately 5 mph (8 km/h) and 18 mph (28 km/h).

■ **Conditions under which the RCTA function will not detect a vehicle**

The RCTA function is not designed to detect the following types of vehicles and/or objects:

- Vehicles approaching from directly behind
- Vehicles backing up in a parking space next to your vehicle
- Vehicles that the sensors cannot detect due to obstructions

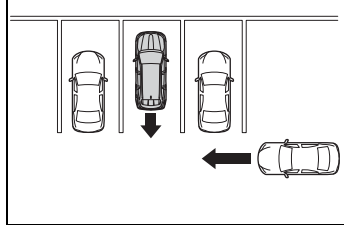

- Guardrails, walls, signs, parked vehicles and similar stationary objects\*
- Small motorcycles, bicycles, pedestrians, etc.\*
- Vehicles moving away from your vehicle
- Vehicles approaching from the parking spaces next to your vehicle\*

\*: Depending on the conditions, detection of a vehicle and/or object may occur.

■ **Conditions under which the RCTA function may not function correctly**

- The RCTA function may not detect vehicles correctly in the following situations:
  - When a sensor is misaligned due to a strong impact to the sensor or its surrounding area
  - When mud, snow, ice, a sticker, etc. is covering a sensor or its surrounding area on the rear bumper
  - When driving on a road surface that is wet with standing water during bad weather, such as heavy rain, snow, or fog
  - When multiple vehicles are approaching with only a small gap between each vehicle
  - If a vehicle is approaching the rear of your vehicle rapidly
  - When a towing eyelet is installed to the rear of the vehicle.
  - When backing up on a slope with a sharp change in grade

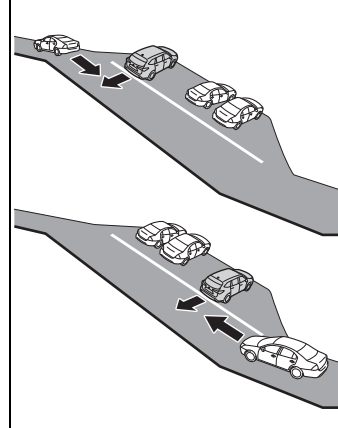

- When backing out of a shallow angle parking spot

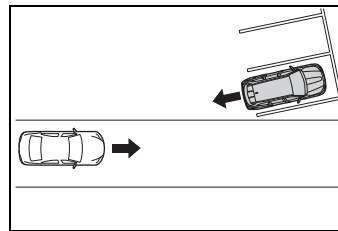

- Immediately after the RCTA function is turned on
- Immediately after the engine is started with the RCTA function on
- When the sensors cannot detect a vehicle due to obstructions

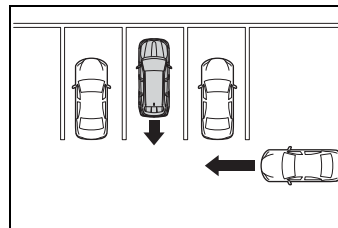

- Instances of the RCTA function unnecessarily detecting a vehicle and/or object may increase in the following situations:
  - When a vehicle passes by the side of your vehicle
  - When the parking space faces a street and vehicles are being driven on the street



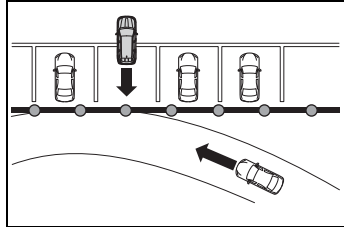

- When the distance between your vehicle and metal objects, such as a guardrail, wall, sign, or parked vehicle, which may reflect electrical waves toward the rear of the vehicle, is short
- When a towing eyelet is installed to the rear of the vehicle

### PKSB (Parking Support Brake)\*

\*: If equipped

The Parking Support Brake system consists of the following functions that operate when driving at a low speed or backing up, such as when parking. When the system determines that the possibility of a collision with a detected object is high, a warning operates to urge the driver to take evasive action. If the system determines that the possibility of a collision with a detected object is extremely high, the brakes are automatically applied to help avoid the collision or help reduce the impact of the collision.

### PKSB (Parking Support Brake) system

#### ■ Parking Support Brake function (static objects) (if equipped)

Ultrasonic sensors are used to detect static objects, such as a wall, in the detection area when driving at a low speed or backing up. (→P.296)

■ **Parking Support Brake function (rear-crossing vehicles) (if equipped)**

Rear radar sensors are used to detect approaching vehicles in the detection area behind the vehicle when backing up. (→P.302)

 **WARNING**

■ **Limitations of the Parking Support Brake system**

Do not overly rely on the system, as doing so may lead to an accident.

- The driver is solely responsible for safe driving. Always drive carefully, taking care to observe your surroundings. The Parking Support Brake system is designed to provide support to lessen the severity of collisions. However, it may not operate in some situations.
- The Parking Support Brake system is not designed to stop the vehicle completely. Additionally, even if the system has stopped the vehicle, it is necessary to depress the brake pedal immediately as brake control will be canceled after approximately 2 seconds.

 **NOTICE**







■ **If “PKSB Unavailable” is displayed on the multi-information display and the PKSB OFF indicator is flashing**

If this message is displayed immediately after the engine switch is changed to ON, operate the vehicle carefully, paying attention to your surroundings. It may be necessary to drive the vehicle for a certain amount of time before the system returns to normal. (If the system is not return to normal after driving for a while, clean the sensors and their surrounding area on the bumpers.)



**Enabling/Disabling the Parking Support Brake**

The Parking Support Brake can be enabled/disabled on the multi-information display. All of the Parking Support Brake functions (static objects and rear-crossing vehicles) are enabled/disabled simultaneously.

Use the meter control switches to enable/disable the parking support brake. (→P.96)

- 1 Press  or  to select .
- 2 Press  or  to select  and then press .

When the Parking Support Brake is disabled, the PKSB OFF indicator (→P.76) illuminates on the instrument cluster.

To re-enable the system when it was disabled, select  on the multi-information display, select 

and turn it on. If the system is disabled, it will remain off even if the engine switch is turned to ON after the engine switch has been turned off.

**Displays and buzzers for engine output restriction control and brake control**

If the engine output restriction control or brake control operates, a buzzer will sound and a message will be displayed on the audio system screen and multi-information display, to alert the driver.

Depending on the situation, engine output restriction control will operate to either limit acceleration or restrict output as much as possible.

- Engine output restriction control is operating (acceleration restriction)

Acceleration greater than a certain amount is restricted by the system.

Audio system screen (Panoramic view monitor) (If equipped): No warning displayed

Multi-information display: "Object Detected Acceleration Reduced"

PKSB OFF indicator: Not illuminated

Buzzer: Does not sound

- Engine output restriction control is operating (output restricted as much as possible)

The system has determined that stronger-than-normal brake operation is necessary.

Audio system screen (Panoramic

view monitor) (If equipped): "BRAKE!"

Multi-information display/Head-up display (if equipped): "Brake!"

PKSB OFF indicator: Not illuminated

Buzzer: Short beep

- Brake control is operating

The system determined that emergency braking is necessary.

Audio system screen (Panoramic view monitor) (If equipped): "BRAKE!"

Multi-information display/Head-up display (if equipped): "Brake!"

PKSB OFF indicator: Not illuminated

Buzzer: Short beep

- Vehicle stopped by system operation

The vehicle has been stopped by brake control operation.

Audio system screen (Panoramic view monitor) (If equipped): "Press Brake Pedal"

Multi-information display/Head-up display (if equipped): "Switch to Brake" (If the accelerator pedal is not depressed, "Press Brake Pedal" will be displayed.)

PKSB OFF indicator: Illuminated

Buzzer: Short beep

### System overview

If the Parking Support Brake determines that a collision with a detected object is possible, the engine output will be restricted to restrain any increase in the vehicle speed. (Engine output restriction control: See figure 2.)

Additionally, if the accelerator pedal continues to be depressed, the brakes will be applied automatically to reduce the vehicle speed. (Brake control: See figure 3.)

- Figure 1 When the PKSB (Parking Support Brake) is disabled

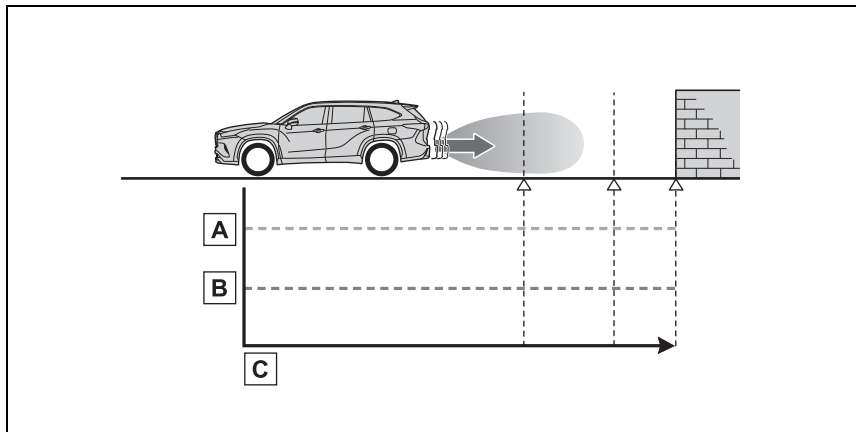

**A** Engine output

**B** Braking force

**C** Time

- Figure 2 When engine output restriction control operates

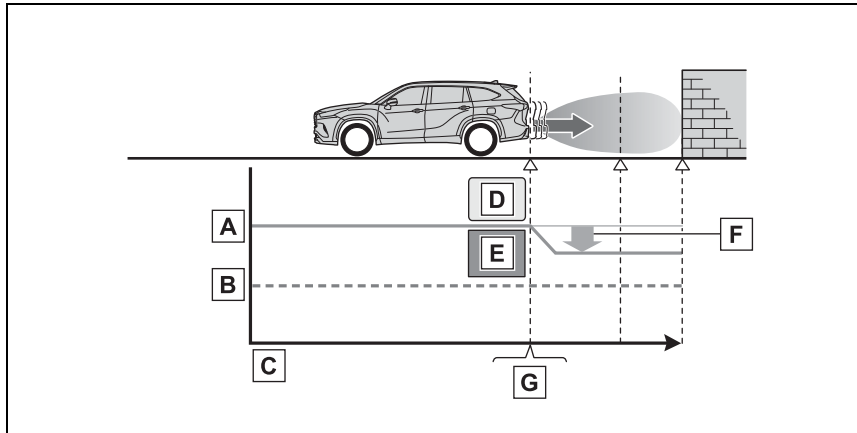

- A** Engine output
- B** Braking force
- C** Time
- D** Engine output restriction control begins operating
- E** System determines that possibility of collision with detected object is high
- F** Engine output reduced
- G** Example: Multi-information display: "Brake!"

● Figure 3 When brake control operates

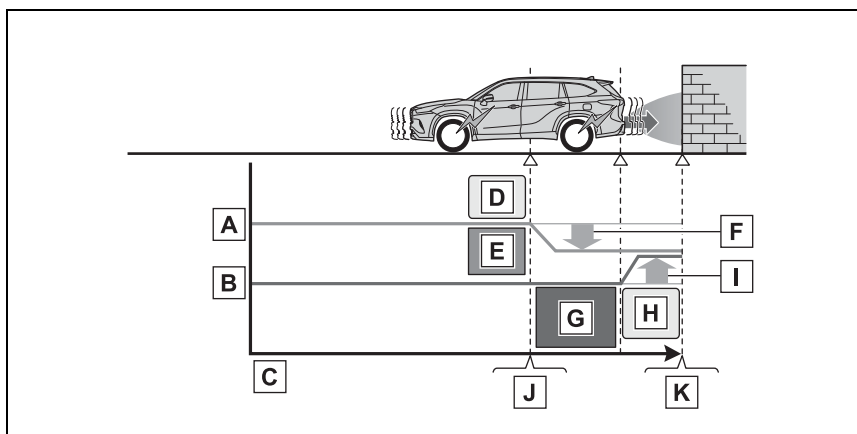

- A** Engine output
- B** Braking force
- C** Time

- D** Engine output restriction control begins operating
- E** System determines that possibility of collision with detected object is high
- F** Engine output reduced
- G** System determines that possibility of collision with detected object is extremely high
- H** Brake control begins operating
- I** Brake control strength increased
- J** Example: Multi-information display: “Brake!”
- K** Example: Multi-information display: “Switch to Brake”

■ **If the Parking Support Brake has operated**

If the vehicle is stopped due to operation of the Parking Support Brake, the Parking Support Brake will be disabled and the PKSB OFF indicator will illuminate. If the Parking Support Brake operates unnecessarily, brake control can be canceled by depressing the brake pedal or waiting for approximately 2 seconds for it to automatically be canceled. Then, the vehicle can be operated by depressing the accelerator pedal.

■ **Re-enabling the Parking Support Brake**

To re-enable the Parking Support Brake when it has been disabled due to system operation perform any of the following operations.

At this time, the PKSB OFF indicator will turn off. (→P.76)

- Turn the PKSB (Parking Support Brake) on (→P.290)
- The shift lever is in P.
- Drive with no operation targets in the traveling direction of the vehicle
- Change the traveling direction of the vehicle

■ **If “PKSB Unavailable” is displayed on the multi-information display and the PKSB OFF indicator is flashing**

- If this message is displayed only when the shift lever is in any position other than R, a sensor on the front or rear bumper may be dirty. Clean the sensors and their surrounding area on the bumpers.
- Initialization may not have been performed after a battery terminal was disconnected and reconnected. Initialize the system. (→P.295)  
If this message continues to be displayed even after initialization, have the vehicle inspected by your Toyota dealer.

■ **If “Parking Assist Unavailable” and “Parking Assist Unavailable Clean Parking Assist Sensor” is displayed on the multi-information display and the PKSB OFF indicator is flashing**

- A sensor may be covered with ice, snow, dirt, etc. Remove the ice, snow, dirt, etc., from the sensor to return the system to normal.  
If this message is shown even after removing dirt from the sensor, or shown when the sensor was not dirty to begin with, have the vehicle inspected by your Toy-

ota dealer.

- A sensor may be frozen. Once the ice melts, the system will return to normal.
- Water may be continuously flowing over the sensor surface, such as in a heavy rain. When the system determines that it is normal, the system will return to normal.

■ **If a battery terminal has been disconnected and reconnected**

The system needs to be initialized. To initialize the system, drive the vehicle straight ahead for 5 seconds or more at a speed of approximately 22 mph (35 km/h) or more.

### Parking Support Brake function (static objects)\*

\*: If equipped

If the sensors detect a static object, such as a wall, in the travelling direction of the vehicle and the system determines that a collision may occur due to the vehicle suddenly moving forward due to an accidental accelerator pedal operation, the vehicle moving the unintended direction due to the wrong shift lever position, or while parking or traveling at low speeds, the system will operate to lessen the impact with the detected static object and reduce the resulting damage.

### Examples of function operation

This function will operate in situations such as the following if an object is detected in the traveling direction of the vehicle.

- When traveling at a low speed and the brake pedal is not depressed, or is depressed late

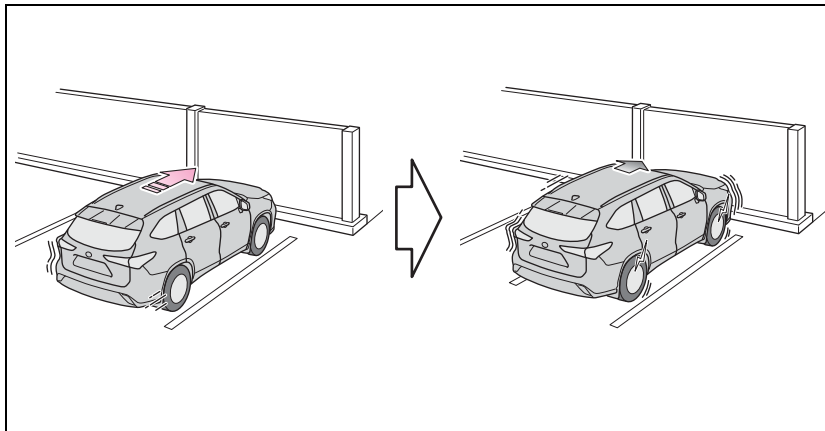



■ When the accelerator pedal is depressed excessively

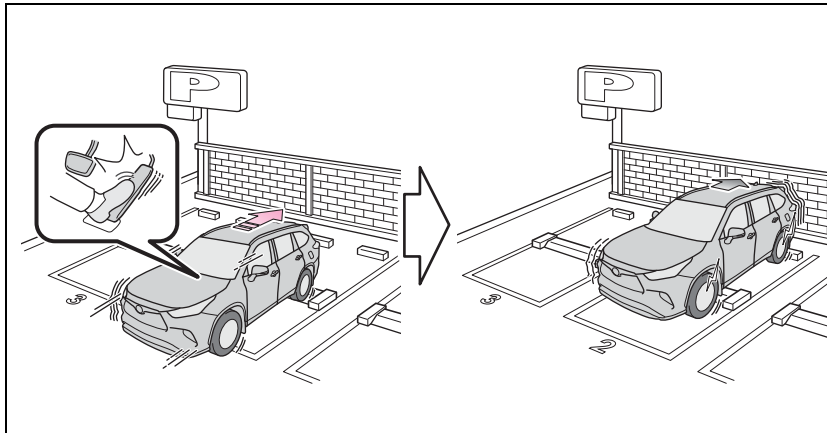

■ When the vehicle moves in the unintended direction due to the wrong shift lever position

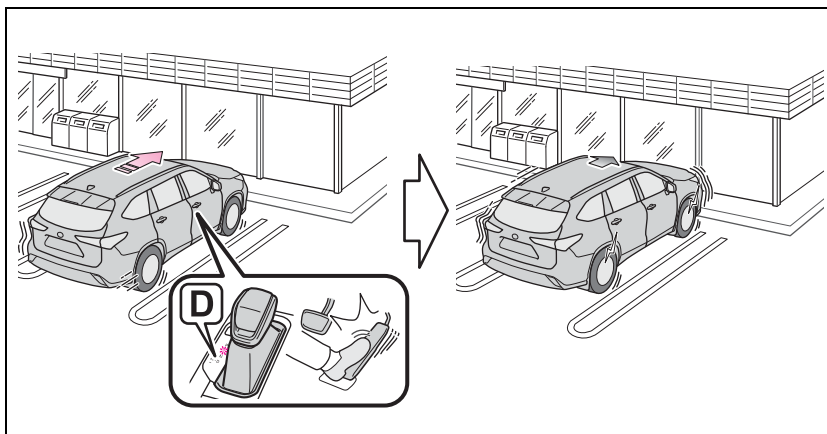

**Types of sensors**

→P.276

**WARNING**

■ To ensure the Parking Support Brake can operate properly

Observe the following precautions regarding the sensors (→P.276). Failure to do so may cause a sensor to not operate properly, and may cause an accident.

● Do not modify, disassemble or paint the sensors.



**WARNING**

- Do not replace a sensor with a part other than a genuine part.
- Do not subject a sensor or its surrounding area to a strong impact.
- Do not damage the sensors, and always keep them clean.
- If the area around a radar sensor is subjected to an impact, the system may not operate properly due to a sensor malfunction. Have the vehicle inspected by your Toyota dealer.

■ **Handling the suspension**

Do not modify the suspension, as changes to the height or inclination of the vehicle may prevent the sensors from detecting objects correctly or cause the system to not operate or operate unnecessarily.

■ **If the Parking Support Brake function (static objects) operates unnecessarily, such as at a railroad crossing**

In the event that the Parking Support Brake function (static objects) operates unnecessarily, such as at a railroad crossing, brake control will be canceled after approximately 2 seconds, allowing you to proceed forward and leave the area, brake control can also be canceled by depressing the brake pedal. Depressing the accelerator pedal after brake control is canceled will allow you to proceed forward and leave the area.

■ **Notes when washing the vehicle**

Do not apply intensive bursts of water or steam to the sensor area.

Doing so may result in the sensor malfunctioning.

- When using a high pressure washer to wash the vehicle, do not spray the sensors directly, as doing so may cause a sensor to malfunction.
- When using steam to clean the vehicle, do not direct steam too close to the sensors as doing so may cause a sensor to malfunction.

■ **When to disable the Parking Support Brake**

In the following situations, disable the Parking Support Brake as the system may operate even though there is no possibility of a collision.

- When inspecting the vehicle using a chassis roller, chassis dynamo or free roller
- When loading the vehicle onto a boat, truck or other transport vessel
- If the suspension has been modified or tires of a size other than specified are installed
- If the front of the vehicle is raised or lowered due to the carried load
- When equipment that may obstruct a sensor is installed, such as a towing eyelet, bumper protector (an additional trim strip, etc.), bicycle carrier, or snow plow
- When using an automatic car wash

■ **The Parking Support Brake function (static object) will operate when**

The function will operate when the PKSB OFF indicator is not illuminated or flashing (→P.75, 76) and all of the following conditions are met:

- Engine output restriction control
- The Parking Support Brake is enabled.
- The vehicle speed is 9 mph (15 km/h) or less.
- There is a static object in the traveling direction of the vehicle and 6 to 13 ft. (2 to 4 m) away.
- The Parking Support Brake determines that a stronger-than-normal brake operation is necessary to avoid a collision.
- Brake control
- Engine output restriction control is operating.
- The Parking Support Brake determines that an immediate brake operation is necessary to avoid a collision.

■ **The Parking Support Brake function (static objects) will stop operating when**

The function will stop operating if any of the following conditions are met:

- Engine output restriction control
- The Parking Support Brake is disabled.
- The system determines that the collision has become avoidable with normal brake operation.
- The static object is no longer 6 to 13 ft. (2 to 4 m) away from the vehicle or in the traveling direction of the vehicle.
- Brake control
- The Parking Support Brake is disabled.
- Approximately 2 seconds have elapsed since the vehicle was stopped by brake control.
- The brake pedal is depressed after the vehicle is stopped by

brake control.

- The static object is no longer 6 to 13 ft. (2 to 4 m) away from the vehicle or in the traveling direction of the vehicle.

■ **Re-enabling the Parking Support Brake function (static objects)**

→P.294

■ **Detection range of the Parking Support Brake function (static objects)**

The detection range of the Parking Support Brake function (static objects) differs from the detection range of the intuitive parking assist. (→P.281) Therefore, even if the intuitive parking assist detects an object and provides a warning, the Parking Support Brake function (static objects) may not start operating.

■ **Objects that the Parking Support Brake function (static objects) may not detect**

The sensors may not be able to detect certain objects, such as the following:

- Pedestrian
- Cotton cloth, snow, and other materials that are poor reflectors of ultrasonic waves
- Objects which are not perpendicular to the ground, are not perpendicular to the traveling direction of the vehicle, are uneven or are waving
- Low objects
- Thin objects such as wires, fences, ropes and signposts
- Objects that are extremely close to the bumper
- Sharply-angled objects
- Tall objects with upper sections projecting outwards in the direction of your vehicle

■ **Situation in which the Parking Support Brake function (static objects) may not operate**

When driving with the shift lever in N.

■ **Intuitive parking assist buzzer**

Regardless of whether the intuitive parking assist system is enabled or not (→P.277), if the Parking Support Brake function (static objects) is enabled (→P.290), the front or rear sensors detect an object and brake control is performed, the intuitive parking assist buzzer will sound to notify the driver of the approximate distance to the object.

■ **Situations in which the Parking Support Brake function (static objects) may operate even if there is no possibility of a collision**

In some situations, such as the following, the Parking Support Brake function (static objects) may operate even though there is no possibility of a collision.

- Vehicle surroundings
- When driving on a narrow road

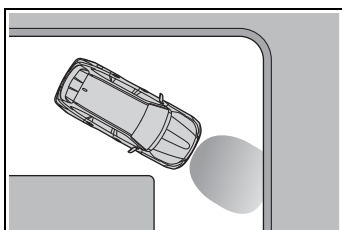

- When driving on a gravel road or in an area with tall grass

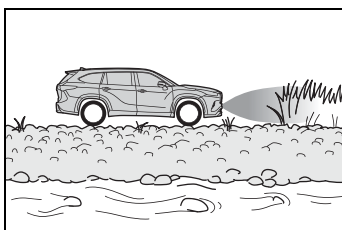

- When driving toward a banner, flag, low-hanging branch or boom

barrier (such as those used at railroad crossings, toll gates and parking lots)

- When driving on a narrow path surrounded by a structure, such as in a tunnel or on an iron bridge
- When parallel parking
- When there is a rut or hole in the surface of the road
- When driving on a metal cover (grating), such as those used for drainage ditches
- When driving on a steep slope
- If a sensor is hit by a large amount of water, such as when driving on a flooded road
- Weather
- If a sensor is covered with ice, snow, dirt, etc. (when cleared, the system will return to normal)
- If heavy rain or water strikes a sensor
- When driving in inclement weather such as fog, snow or a sandstorm
- When strong winds are blowing
- Other ultrasonic wave sources
- When vehicle horns, vehicle detectors, motorcycle engines, air brakes of large vehicles, the clearance sonar of other vehicles or other devices which produce ultrasonic waves are near the vehicle
- If a sticker or an electronic component, such as a backlit license plate (especially fluorescent type), fog lights, fender pole or wireless antenna is installed near a sensor
- Changes in the vehicle posture
- If the vehicle is significantly tilted
- If the front of the vehicle is raised or lowered due to the carried load
- If the orientation of a sensor has been changed due to a collision or other impact
- If a sensor has been painted or covered with a sticker, etc.

■ **Situations in which the Parking Support Brake function (static objects) may not operate properly**

In some situations, such as the following, this function may not oper-

ate properly.

- Weather
- When a sensor or the area around a sensor is extremely hot or cold

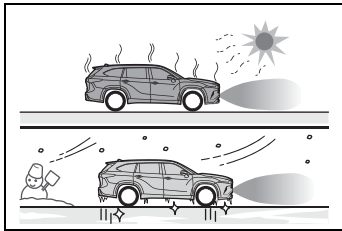

- When strong winds are blowing

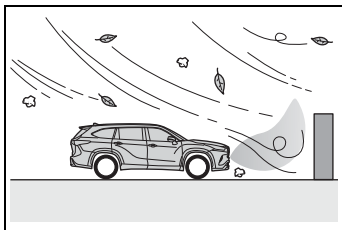

- If a sensor is covered with ice, snow, dirt, etc. (when cleared, the system will return to normal)
- If heavy rain or water strikes a sensor
- When driving in inclement weather such as fog, snow or a sandstorm
- When the sensor is frozen (Once the sensor thaws, the system will return to normal)
- Vehicle surroundings
- When an object that cannot be detected is between the vehicle and a detected object
- If an object such as a vehicle, motorcycle, bicycle or pedestrian cuts in front of the vehicle or runs out from the side of the vehicle
- The vehicle is approaching a tall or curved curb.
- On an extremely bumpy road, on an incline, on gravel, or on grass.
- If objects draw too close to the sensor.
- Other ultrasonic waves sources
- When vehicle horns, vehicle detectors, motorcycle engines, air brakes of large vehicles, the clearance sonar of other vehicles or

- other devices which produce ultrasonic waves are near the vehicle
- If a sticker or an electronic component, such as a backlit license plate (especially fluorescent type), fog lights, fender pole or wireless antenna is installed near a sensor
- Changes in the vehicle posture
- If the vehicle is significantly tilted
- If the front of the vehicle is raised or lowered due to the carried load
- If the orientation of a sensor has been changed due to a collision or other impact
- When equipment that may obstruct a sensor is installed, such as a bumper protector (an additional trim strip, etc.), bicycle carrier, or snow plow
- If the suspension has been modified or tires of a size other than specified are installed
- If a sensor has been painted or covered with a sticker, etc.

### Parking Support Brake function (rear-crossing vehicles)\*

\*: If equipped

If a rear radar sensor detects a vehicle approaching from the right or left at the rear of the vehicle and the system determines that the possibility of a collision is high, this function will perform brake control to reduce the likelihood of an impact with the approaching vehicle.

#### Examples of function operation

This function will operate in situations such as the following if a vehicle is detected in the traveling direction of the vehicle.

- When reversing, a vehicle is approaching and the brake pedal is not depressed, or is depressed late

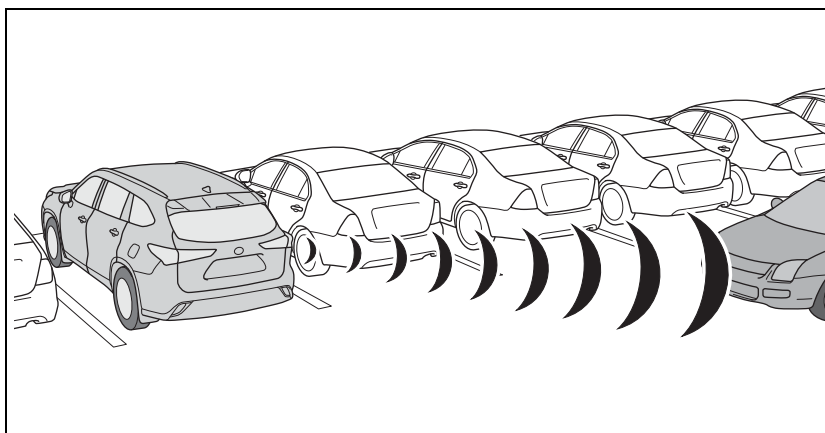

#### Types of sensors

→P.272

#### ⚠ WARNING

- To ensure the Parking Support Brake function (rear-crossing vehicles) can operate properly

Observe the following precautions regarding the rear radar sensors (→P.272). Failure to do so may cause a sensor to not operate properly, and may cause an accident.



**WARNING**

- Do not modify, disassemble or paint the sensors.
- Do not replace a rear radar sensor with a part other than a genuine part.
- Do not damage the rear radar sensors, and always keep the radar sensors and their surrounding area on the bumper clean.
- If the area around a rear radar sensor is subjected to an impact, the system may not operate properly due to a sensor malfunction. Have the vehicle inspected by your Toyota dealer.
- Observe the rear radar sensor handling precautions. (→P.272)

■ **The Parking Support Brake function (rear-crossing vehicles) will operate when**

The function will operate when the PKSB OFF indicator is not illuminated or flashing (→P.75, 76) and all of the following conditions are met:

- Engine output restriction control
  - The Parking Support Brake is enabled.
  - The vehicle speed is 9 mph (15 km/h) or less.
  - Vehicles which are approaching from the right or left at the rear of the vehicle at a traveling speed of less than approximately 5 mph (8 km/h)
  - The shift lever is in R.
  - The Parking Support Brake determines that a stronger than normal brake operation is necessary to avoid a collision with an approaching vehicle.
- Brake control
  - Engine output restriction control is operating.

- The Parking Support Brake determines that an emergency brake operation is necessary to avoid a collision with an approaching vehicle.

■ **The Parking Support Brake function (rear-crossing vehicles) will stop operating when**

The function will stop operating if any of the following conditions are met:

- Engine output restriction control
  - The Parking Support Brake is disabled.
  - The collision becomes avoidable with normal brake operation.
  - A vehicle is no longer approaching from the right or left at the rear of the vehicle.
- Brake control
  - The Parking Support Brake is disabled.
  - Approximately 2 seconds have elapsed since the vehicle was stopped by brake control.
  - The brake pedal is depressed after the vehicle is stopped by brake control.
  - A vehicle is no longer approaching from the right or left at the rear of the vehicle.

■ **Re-enabling the Parking Support Brake function (rear-crossing vehicles)**

→P.294

■ **Detection area of the Parking Support Brake function (rear-crossing vehicles)**

The detection area of the Parking Support Brake function (rear-crossing vehicles) differs from the detection area of the RCTA function (→P.287). Therefore, even if the RCTA function detects a vehicle and provides an alert, the Parking Support Brake function (rear-crossing vehicles) may not start operating.

■ **Conditions under which the Parking Support Brake function (rear-crossing vehicles) will not detect a vehicle**

The Parking Support Brake function (rear-crossing vehicles) is not designed to detect the following types of vehicles and/or objects:

- Vehicles approaching from directly behind
- Vehicles backing up in a parking space next to your vehicle
- Vehicles that the sensors cannot detect due to obstructions

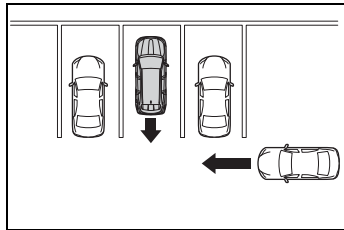

- Vehicles which suddenly accelerate or decelerate near your vehicle
- Guardrails, walls, signs, parked vehicles and similar stationary objects
- Small motorcycles, bicycles, pedestrians, etc.\*
- Vehicles moving away from your vehicle
- Vehicles approaching from the parking spaces next to your vehicle\*
- Objects which are extremely close to a radar sensor\*
- Vehicles which are approaching from the right or left at the rear of the vehicle at a traveling speed of less than approximately 5 mph (8 km/h)
- Vehicles which are approaching from the right or left at the rear of the vehicle at a traveling speed of more than approximately 15 mph (24 km/h)

\*: Depending on the conditions, detection of a vehicle and/or object may occur.

■ **PKSB buzzer**

If the Parking Support Brake is enabled and brake control is performed, a buzzer will sound to notify the driver.

■ **Situations in which the system may operate even though there is no possibility of a collision**

In some situations such as the following, the Parking Support Brake function (rear-crossing vehicles) may operate even though there is no possibility of a collision.

- When the parking space faces a street and vehicles are being driven on the street

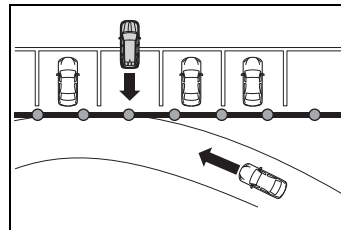

- When a detected vehicle turns while approaching the vehicle

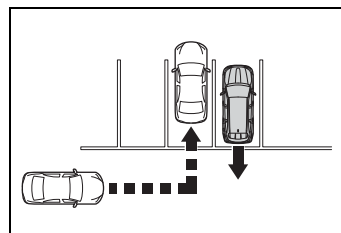

- When a vehicle passes by the side of your vehicle

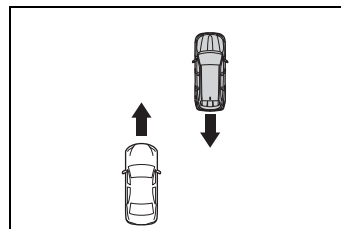



- When the distance between your vehicle and metal objects, such as a guardrail, wall, sign, or parked vehicle, which may reflect electrical waves toward the rear of the vehicle, is short

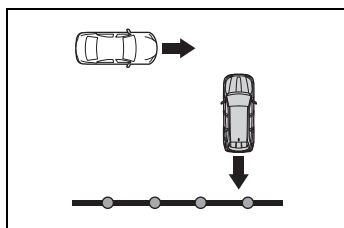

- When there are spinning objects near your vehicle such as the fan of an air conditioning unit
- When water is splashed or sprayed toward the rear bumper, such as from a sprinkler

■ **Situations in which the Parking Support Brake function (rear-crossing vehicles) may not operate properly**

In some situations, such as the following, the radar sensors may not detect an object and this function may not operate properly

- Stationary objects
- When a sensor or the area around a sensor is extremely hot or cold
- If the rear bumper is covered with ice, snow, dirt, etc.
- If a sensor has been painted or covered with a sticker, etc.
- When it is raining heavily or water strikes the vehicle
- If the vehicle is significantly tilted
- When equipment that may obstruct a sensor is installed, such as a towing eyelet, bumper protector (an additional trim strip, etc.), bicycle carrier, or snow plow
- If the suspension has been modified or tires of a size other than specified are installed
- If the front of the vehicle is raised

or lowered due to the carried load

- If an electronic component, such as a backlit license plate (especially fluorescent type), fog lights, fender pole or wireless antenna is installed near a radar sensor
- If the orientation of a radar sensor has been changed
- When multiple vehicles are approaching with only a small gap between each vehicle
- If a vehicle is approaching the rear of your vehicle rapidly
- Situations in which the radar sensor may not detect a vehicle
- When a vehicle approaches from the right or left at the rear of the vehicle while you are turning while backing up
- When turning while backing up

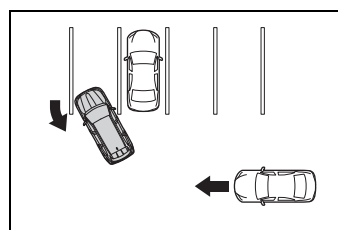

- When backing out of a shallow angle parking spot

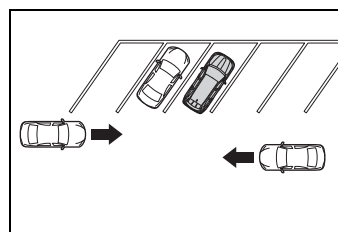

- When backing up on a slope with a sharp change in grade

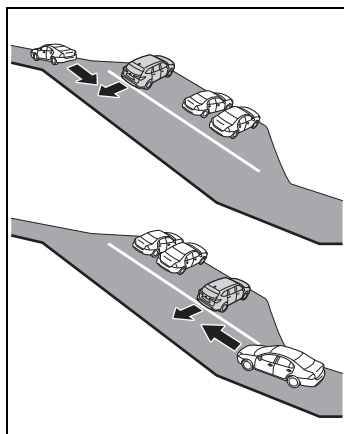

- When a vehicle turns into the detection area

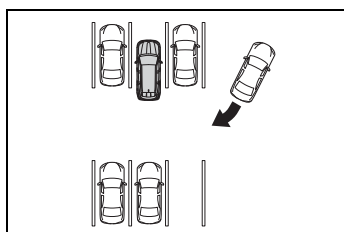

## Driving mode select switch

The driving modes can be selected to suit the driving and usage conditions.

## Selecting a driving mode

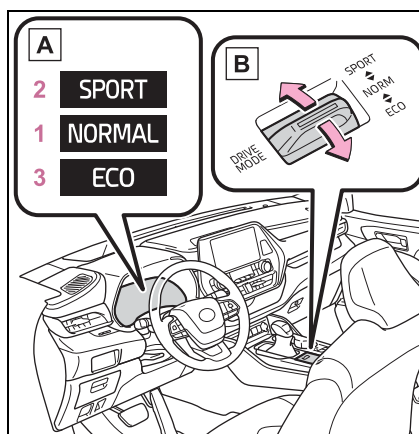

**A** Multi-information display

**B** Driving mode select switch

Operate the driving mode select switch forward or backward to select the desired driving mode on the multi-information display.

### 1 Normal mode

Provides an optimal balance of fuel economy, quietness, and dynamic performance. Suitable for normal driving.

### 2 Sport mode

Controls the transmission and engine to provide quick, powerful acceleration. This mode also changes the steering feel, making it suitable for when agile driving response is desired, such as when

driving on roads with many curves. When Sport mode is selected, Sport mode indicator comes on.

**3 Eco drive mode**

Helps the driver accelerate in an eco-friendly manner and improve fuel economy through moderate throttle characteristics and by controlling the operation of the air conditioning system (heating/cooling). When Eco drive mode is selected, Eco drive mode indicator comes on.

■ **When changing to a driving mode other than normal mode**

Switches to AWD control suitable for the selected mode. (for Dynamic Torque Vectoring AWD vehicles only)

■ **Air conditioning system operation in Eco drive mode**

In Eco drive mode, heating/cooling operations and the fan speed is controlled to improve fuel efficiency. Perform the following procedures to increase the air conditioning performance.

- Vehicle with a 12.3-inch display: Turn eco air conditioning mode off (→P.341)
- Adjust the fan speed (→P.328, 334)
- Cancel Eco drive mode

■ **Canceling a driving mode**

- Sport mode is automatically canceled and the driving mode returns to normal mode when the engine switch is turned off.
- Normal mode and Eco drive mode are not canceled until another driving mode is selected. (Even if the engine switch is turned off, normal mode and Eco drive mode will not be automatically canceled.)

**Multi-terrain Select (AWD vehicles)**

**Multi-terrain Select is a system that improves drivability in off-road situations.**

**When driving over muddy, sandy or rough road surfaces, the system selects a suitable driving mode to switch AWD, brake and drive force control to perform control suitable for the road condition.**

 **WARNING**

■ **Before using Multi-terrain Select**

Make sure to observe the following precautions. Failure to observe these precautions may result in an unexpected accident.

- Check that the Mud & Sand and Rock & Dirt indicators are illuminated before driving. Multi-terrain Select will not operate when the indicators are off.
- Do not rely solely upon the Multi-terrain Select. This function is not intended to expand the limits of the vehicle. If the system is continuously used for a long period of time, the load on related parts increases and the system may be unable to operate normally, which may lead to an accident. Thoroughly check the road conditions and driving route before driving, and drive with caution.

**⚠ WARNING**

● The road conditions listed (Guidelines for selecting each mode: →P.308) are for reference only. There is a chance that the function may not be the most appropriate in terms of road conditions such as pitch, slipperiness, undulation, etc. Thoroughly check the road conditions before driving.

**Guidelines for selecting each mode**

Control that is suitable for the following road conditions can be performed by switching to either of the two modes. Select a mode that is appropriate for the road condition.

■ **Mud & Sand mode**

Suitable for driving on roads with increased driving resistance such as sandy roads, muddy roads, etc.

■ **Rock & Dirt mode**

Suitable for driving in bumpy road conditions, such as on unpaved forest roads.

**Changing the mode**

■ **Dynamic Torque Control AWD vehicles**

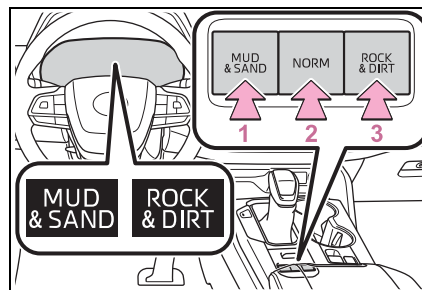

**1 Mud & Sand mode**

When the switch is pressed while not in Mud & Sand mode, the system switches to Mud & Sand mode and the Mud & Sand mode indicator, VSC OFF indicator and PCS warning light illuminate on the multi-information display.

**2 Normal mode**

Mode that performs AWD, brake and drive force control suitable for driving on general roads. Use normal mode when not driving off-road.

The driving mode returns to normal mode if the switch is pressed while in Mud & Sand mode or Rock & Dirt mode.

**3 Rock & Dirt mode**

When the switch is pressed while not in Rock & Dirt mode, the system switches to Rock & Dirt mode and the Rock & Dirt mode indicator illuminates on the multi-information display.

■ **Dynamic Torque Vectoring AWD vehicles**

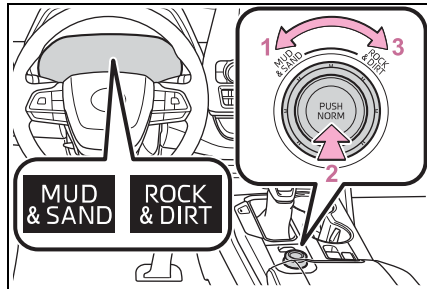

**1** Mud & Sand mode

When the switch is turned to the left while not in Mud & Sand mode, the system switches to Mud & Sand mode and the Mud & Sand mode indicator, VSC OFF indicator and PCS warning light illuminate on the multi-information display.

**2** Normal mode

Mode that performs AWD, brake and drive force control suitable for driving on general roads. Use normal mode when not driving off-road.

The driving mode returns to normal mode if the switch is pressed while in Mud & Sand mode or Rock & Dirt mode.

**3** Rock & Dirt mode

When the switch is turned to the right while not in Rock & Dirt mode, the system switches to Rock & Dirt mode and the Rock & Dirt mode indicator illuminates on the multi-information display.

■ **Multi-terrain Select**

- Multi-terrain Select is intended for use when driving on rough roads. Drive in normal mode during normal driving.
- The Mud & Sand and Rock & Dirt

modes control the vehicle so that it can maximize the drive force and improve drivability on rough roads. As a result, fuel efficiency may diminish when compared to driving in normal mode.

■ **If Mud & Sand or Rock & Dirt mode is selected**

- The background of the multi-information display will change following the Multi-terrain Select mode.
- The AWD operation status display will automatically switch on the multi-information display.

■ **AWD control for Mud & Sand and Rock & Dirt modes**

If the vehicle speed exceeds the speeds listed below, AWD control is performed similar to that performed in Normal mode, even if Mud & Sand or Rock & Dirt mode is selected.

- Mud & Sand mode: Vehicle speed is approximately 25 mph (40 km/h) or more
- Rock & Dirt mode: Vehicle speed is approximately 16 mph (25 km/h) or more

If the vehicle speed drops below the above speeds, the system automatically switches to the AWD control suitable for each mode.

■ **When Multi-terrain Select brake control temporarily stops operating**

If Mud & Sand or Rock & Dirt mode is continuously used for a long period of time, the brakes may overheat, and Multi-terrain Select brake control may temporarily stop operating.

- At this time, the buzzer sounds intermittently and "Traction Control Turned OFF" is displayed on the multi-information display.
- If Multi-terrain Select brake control stops operating, stop the vehicle in a safe location as soon as possible\* and wait until the system

temperature decreases. Once the display message on the multi-information display turns off, the brake control returns to normal. Note that normal driving is still possible even when Multi-terrain Select brake control is not operating.

\*: After stopping the vehicle, do not stop the engine until the display message has turned off.

■ **When Mud & Sand or Rock & Dirt mode is canceled**

In the following situations, Mud & Sand mode or Rock & Dirt mode are automatically canceled even if they are selected.

- When the driving mode is changed (P.306)
- When the engine switch is turned off

■ **Driving in Mud & Sand or Rock & Dirt mode**

The following types of situations may occur, but they are not malfunctions.

- Vibrations may be felt throughout the vehicle or steering wheel
- Operating noise may be heard from the engine compartment

■ **When an inspection at your Toyota dealer is necessary**

In the following situations, the system may be malfunctioning. Have the vehicle inspected by your Toyota dealer immediately.

- When the slip indicator light illuminates while Mud & Sand or Rock & Dirt mode is selected
- When the indicator for each mode does not illuminate even though Mud & Sand or Rock & Dirt mode is selected

**Snow mode switch**

**Snow mode can be selected to suit the conditions when driving on slippery road surfaces, such as on snow.**

**System operation**

Press the snow mode switch.

When the switch is pressed, the system switches to snow mode and the snow mode indicator illuminates on the multi-information display.

When the switch is pressed again, the snow mode indicator turns off.

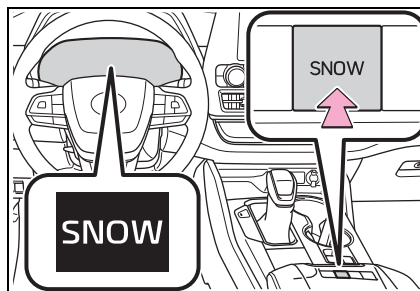

■ **When changing to snow mode**

The background of the multi-information display changes.

■ **Canceling the snow mode**

Snow mode is automatically canceled when the engine switch is turned OFF or Mud & Sand or Rock & Dirt mode is selected for Multi-terrain Select.

**Downhill assist control system\***

\*: If equipped

**The downhill assist control system helps to prevent excessive speed on steep downhill slopes. The system will operate when the vehicle is traveling under 18 mph (30 km/h).**

**⚠ WARNING**

**■ When using downhill assist control system**

Do not rely overmuch on the downhill assist control system. This function does not extend the vehicle's performance limitations. Always thoroughly check the road conditions, and drive safely.

**System operation**

Press the "DAC" switch.  
 The downhill assist control system indicator will come on and the system will operate.  
 When the system is in operation, the slip indicator will flash, and the stop lights/high mounted stop lights will be lit. A sound may also occur during the operation. This does not indicate a malfunction.

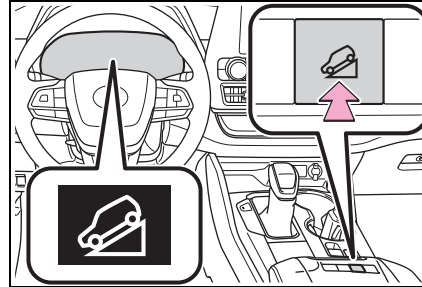

**Turning off the system**

Press the "DAC" switch while the system is in operation.  
 The downhill assist control system indicator will flash as the system gradually ceases operation, and will turn off when the system is fully off. Press the "DAC" switch while the downhill assist control system indicator is flashing to start the system again.

**■ Operating tips**

The system will operate when the shift lever is in a position other than P, however to make effective use of the system it is recommended to select a lower shift range.

**■ If the downhill assist control system indicator flashes**

- In the following situations, the indicator flashes and the system will not operate:
  - The shift lever is in a position P.
  - The vehicle speed exceeds approximately 18 mph (30 km/h).
  - The brake system overheats.
- In the following situation, the indicator flashes to alert the driver, but the system will operate:
  - The "DAC" switch is turned off while the system is operating.

The system will gradually cease operation. The indicator will flash during operation, and then go off

when the system is fully off.

■ **When the downhill assist control system is operated continuously**

This may cause the brake actuator to overheat. In this case, the downhill assist control system will stop operating, a buzzer will sound and the downhill assist control system indicator will start flashing, and “Traction Control Turned OFF” will be shown on the multi-information display. Refrain from using the system until the downhill assist control system indicator stays on and the message goes off. (The vehicle can be driven normally during this time.)

■ **Sounds and vibrations caused by the downhill assist control system**

- A sound may be heard from the engine compartment when the engine is started or just after the vehicle begins to move. This sound does not indicate that a malfunction has occurred in downhill assist control system.
- Either of the following conditions may occur when the downhill assist control system is operating. None of these are indicators that a malfunction has occurred.
  - Vibrations may be felt through the vehicle body and steering.
  - A motor sound may be heard after the vehicle comes to a stop.

■ **System malfunction**

In the following cases, have your vehicle checked by your Toyota dealer.

- The downhill assist control system indicator does not come on when the engine switch is turned to ON.
- The downhill assist control system indicator does not come on when the “DAC” switch is pressed.
- The slip indicator comes on.

 **WARNING**

■ **The system may not operate on the following surfaces, which may lead to an accident causing death or serious injury**

- Slippery surfaces such as wet or muddy roads
- Icy surface
- Unpaved roads



**Driving assist systems**

**To keep driving safety and performance, the following systems operate automatically in response to various driving situations. Be aware, however, that these systems are supplementary and should not be relied upon too heavily when operating the vehicle.**

**Summary of the driving assist systems**

■ **ABS (Anti-lock Brake System)**

Helps to prevent wheel lock when the brakes are applied suddenly, or if the brakes are applied while driving on a slippery road surface

■ **Brake assist**

Generates an increased level of braking force after the brake pedal is depressed when the system detects a panic stop situation

■ **VSC (Vehicle Stability Control)**

Helps the driver to control skidding when swerving suddenly or turning on slippery road surfaces

■ **Enhanced VSC (Enhanced Vehicle Stability Control)**

Provides cooperative control of the ABS, TRAC, VSC and EPS. Helps to maintain directional stability when swerving on slippery road surfaces by controlling steering performance.

■ **Trailer Sway Control**

Helps the driver to control trailer sway by selectively applying brake pressure for individual wheels and reducing driving torque when trailer sway is detected.

■ **TRAC (Traction Control)**

Helps to maintain drive power and prevent the drive wheels from spinning when starting the vehicle or accelerating on slippery roads

■ **Active Cornering Assist (ACA)**

Helps to prevent the vehicle from drifting to the outer side by performing inner wheel brake control when attempting to accelerate while turning

■ **Hill-start assist control**

Helps to reduce the backward movement of the vehicle when starting on an uphill

■ **EPS (Electric Power Steering)**

Employs an electric motor to reduce the amount of effort needed to turn the steering

wheel

■ **Dynamic Torque Control AWD system (AWD models)**

Automatically switches from front-wheel drive to all-wheel drive (AWD) according to the driving conditions, helping to ensure reliable handling and stability. Examples of conditions where the system will switch to AWD are when cornering, going uphill, starting off or accelerating, and when the road surface is slippery due to snow, rain, etc.

■ **Dynamic Torque Vectoring AWD system (AWD models)**

Automatically switches from front-wheel drive to all-wheel drive (AWD) according to the driving conditions, helping to ensure reliable handling and stability. Examples of conditions where the system will switch to AWD are when cornering, going uphill, starting off or accelerating, and when the road surface is slippery due to snow, rain, etc.

Also, when the vehicle is cornering, the drive torque distribution between the front and rear wheels and between the rear left and right wheels is precisely controlled to improve drivability and stability.

■ **The Secondary Collision Brake**

When the SRS airbag sensor detects a collision and the sys-

tem operates, the brakes and brake lights are automatically controlled to reduce the vehicle speed and help reduce the possibility of further damage due to a secondary collision.

■ **When the TRAC/VSC/Trailer Sway Control systems are operating**

The slip indicator light will flash while the TRAC/VSC/Trailer Sway Control systems are operating.

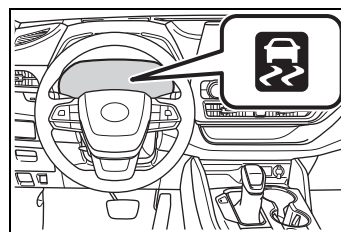

■ **Disabling the TRAC system**

If the vehicle gets stuck in mud, dirt or snow, the TRAC system may reduce power from the engine to the wheels. Pressing the  switch to turn the system off may make it easier for you to rock the vehicle in order to free it.

To turn the TRAC system off, quickly press and release the  switch.

The “Traction Control Turned OFF” will be shown on the multi-information display.

Press the  switch again to turn the system back on.

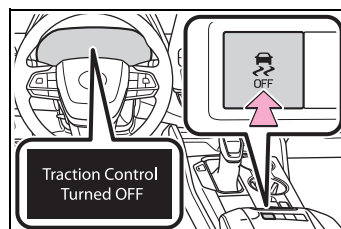

■ **Turning off both TRAC, VSC and Trailer Sway Control systems**

To turn the TRAC, VSC and Trailer Sway Control systems off, press and hold the  switch for more than 3 seconds while the vehicle is stopped.

The VSC OFF indicator light will come on and the “Traction Control Turned OFF” will be shown on the multi-information display.\*

Press the  switch again to turn the system back on.

\*: On vehicles with PCS (Pre-Collision System), PCS will also be disabled (only Pre-Collision warning is available). The PCS warning light will come on and a message will be displayed on the multi-information display. (→P.233)

■ **When the message is displayed on the multi-information display showing that TRAC has been disabled even if the  switch has not been pressed**

TRAC is temporary deactivated. If the information continues to show, contact your Toyota dealer.

■ **Operating conditions of hill-start assist control**

When the following four conditions are met, the hill-start assist control will operate:

- The shift lever is in a position other than P or N (when starting off forward/backward on an upward incline)
- The vehicle is stopped
- The accelerator pedal is not depressed
- The parking brake is not engaged

■ **Automatic system cancelation of hill-start assist control**

The hill-start assist control will turn off in any of the following situations:

- The shift lever is shifted to P or N
- The accelerator pedal is depressed
- The parking brake is engaged
- 2 seconds at maximum elapsed after the brake pedal is released

■ **Sounds and vibrations caused by the ABS, brake assist, VSC, Trailer Sway Control, TRAC and hill-start assist control systems**

- A sound may be heard from the engine compartment when the brake pedal is depressed repeatedly, when the engine is started or just after the vehicle begins to move. This sound does not indicate that a malfunction has occurred in any of these systems.
- Any of the following conditions may occur when the above systems are operating. None of these indicates that a malfunction has occurred.
  - Vibrations may be felt through the vehicle body and steering.
  - A motor sound may be heard also after the vehicle comes to a stop.
  - The brake pedal may pulsate slightly after the ABS is activated.
  - The brake pedal may move down slightly after the ABS is activated.

■ **Active Cornering Assist operation sounds and vibrations**

When the Active Cornering Assist is operated, operation sounds and vibrations may be generated from the brake system, but this is not a malfunction.

■ **AWD system operation sounds and vibrations when switching between AWD and front wheel drive**

When the vehicle switches from AWD to front wheel drive and vice versa, operation sounds and vibra-

tions may be generated, but this is not a malfunction.

■ **EPS operation sound**

When the steering wheel is operated, a motor sound (whirring sound) may be heard. This does not indicate a malfunction.

■ **Reduced effectiveness of the EPS system**

The effectiveness of the EPS system is reduced to prevent the system from overheating when there is frequent steering input over an extended period of time. The steering wheel may feel heavy as a result. Should this occur, refrain from excessive steering input or stop the vehicle and turn the engine off. The EPS system should return to normal within 10 minutes.

■ **Automatic reactivation of TRAC, Trailer Sway Control and VSC systems**

After turning the TRAC, Trailer Sway Control and VSC systems off, the systems will be automatically re-enabled in the following situations:

- When the engine switch is turned OFF
- If only the TRAC system is turned off, the TRAC will turn on when vehicle speed increases
- If both the TRAC and VSC systems are turned off, automatic re-enabling will not occur when vehicle speed increases.

■ **Operating conditions of Active Cornering Assist**

The system operates when the following occurs.

- TRAC/VSC can operate
- The driver is attempting to accelerate while turning
- The system detects that the vehicle is drifting to the outer side
- The brake pedal is released

■ **Secondary Collision Brake operating conditions**

The system operates when the SRS airbag sensor detects a collision while the vehicle is in motion. However, the system does not operate in any of the following situations.

- The vehicle speed is below 6 mph (10 km/h)
- Components are damaged

■ **Secondary Collision Brake automatic cancellation**

The system is automatically canceled in any of the following situations.

- The vehicle speed drops below approximately 6 mph (10 km/h)
- A certain amount of time elapses during operation
- The accelerator pedal is depressed a large amount

 **WARNING**

■ **The ABS does not operate effectively when**

- The limits of tire gripping performance have been exceeded (such as excessively worn tires on a snow covered road).
- The vehicle hydroplanes while driving at high speed on wet or slick roads.

■ **Stopping distance when the ABS is operating may exceed that of normal conditions**

The ABS is not designed to shorten the vehicle's stopping distance. Always maintain a safe distance from the vehicle in front of you, especially in the following situations:

- When driving on dirt, gravel or snow-covered roads
- When driving with tire chains

 **WARNING**

- When driving over bumps in the road
- When driving over roads with potholes or uneven surfaces

■ **TRAC/VSC may not operate effectively when**

Directional control and power may not be achievable while driving on slippery road surfaces, even if the TRAC/VSC system is operating. Drive the vehicle carefully in conditions where stability and power may be lost.

■ **Active Cornering Assist does not operate effectively when**

- Do not overly rely on Active Cornering Assist. Active Cornering Assist may not operate effectively when accelerating down slopes or driving on slippery road surfaces.
- When Active Cornering Assist frequently operates, Active Cornering Assist may temporarily stop operating to ensure proper operation of the brakes, TRAC and VSC.

■ **Hill-start assist control does not operate effectively when**

- Do not overly rely on hill-start assist control. Hill-start assist control may not operate effectively on steep inclines and roads covered with ice.
- Unlike the parking brake, hill-start assist control is not intended to hold the vehicle stationary for an extended period of time. Do not attempt to use hill-start assist control to hold the vehicle on an incline, as doing so may lead to an accident.

■ **When the TRAC/VSC/Trailer Sway Control is activated**

The slip indicator light flashes. Always drive carefully. Reckless driving may cause an accident. Exercise particular care when the indicator light flashes.

■ **When the TRAC/VSC/Trailer Sway Control systems are turned off**

- Be especially careful and drive at a speed appropriate to the road conditions. As these are the systems to help ensure vehicle stability and driving force, do not turn the TRAC/VSC/Trailer Sway Control systems off unless necessary.
- Trailer Sway Control is part of the VSC system and will not operate if VSC is turned off or experiences a malfunction.

■ **Dynamic Torque Vectoring AWD system**

The cornering performance of the AWD system has been improved. However, do not overly rely on the system and drive with caution.

■ **Replacing tires**

Make sure that all tires are of the specified size, brand, tread pattern and total load capacity. In addition, make sure that the tires are inflated to the recommended tire inflation pressure level.

The ABS, TRAC, Trailer Sway Control and VSC systems will not function correctly if different tires are installed on the vehicle. Contact your Toyota dealer for further information when replacing tires or wheels.

 **WARNING**

■ **Handling of tires and the suspension**

Using tires with any kind of problem or modifying the suspension will affect the driving assist systems, and may cause a system to malfunction.

■ **Trailer Sway Control precaution**

The Trailer Sway Control system is not able to reduce trailer sway in all situations. Depending on many factors such as the conditions of the vehicle, trailer, road surface and driving environment, the Trailer Sway Control system may not be effective. Refer to your trailer owner's manual for information on how to tow your trailer properly.

■ **If trailer sway occurs**

Observe the following precautions.

Failing to do so may cause death or serious injury.

- Firmly grip the steering wheel. Steer straight ahead. Do not try to control trailer sway by turning the steering wheel.
- Begin releasing the accelerator pedal immediately but very gradually to reduce speed. Do not increase speed. Do not apply vehicle brakes.

If you make no extreme correction with the steering or brakes, your vehicle and trailer should stabilize. (→P.189)

■ **Secondary Collision Brake**

Do not rely solely upon the Secondary Collision Brake. This system is designed to help reduce the possibility of further damage due to a secondary collision, however, that effect changes according to various conditions. Overly relying on the system may result in death or serious injury.

**Winter driving tips**

**Carry out the necessary preparations and inspections before driving the vehicle in winter. Always drive the vehicle in a manner appropriate to the prevailing weather conditions.**

**Pre-winter preparations**

- Use fluids that are appropriate to the prevailing outside temperatures.
- Engine oil
- Engine coolant
- Washer fluid
- Have a service technician inspect the condition of the battery.
- Have the vehicle fitted with four snow tires or purchase a set of tire chains for the front tires.

Ensure that all tires are the same size and brand, and that chains match the size of the tires.

 **WARNING**

■ **Driving with snow tires**

Observe the following precautions to reduce the risk of accidents. Failure to do so may result in a loss of vehicle control and cause death or serious injury.

- Use tires of the specified size.
- Maintain the recommended level of air pressure.

● Do not drive in excess of 75 mph (120 km/h), regardless of the type of snow tires being used.

● Use snow tires on all, not just some wheels.

■ **Driving with tire chains**

Observe the following precautions to reduce the risk of accidents. Failure to do so may result in the vehicle being unable to be driven safely, and may cause death or serious injury.

● Do not drive in excess of the speed limit specified for the tire chains being used, or 30 mph (50 km/h), whichever is lower.

● Avoid driving on bumpy road surfaces or over potholes.

● Avoid sudden acceleration, abrupt steering, sudden braking and shifting operations that cause sudden engine braking.

● Slow down sufficiently before entering a curve to ensure that vehicle control is maintained.

● Do not use the LTA (Lane Tracing Assist) system.

 **NOTICE**

■ **Repairing or replacing snow tires**

Request repairs or replacement of snow tires from Toyota dealers or legitimate tire retailers. This is because the removal and attachment of snow tires affects the operation of the tire pressure warning valves and transmitters.

**Before driving the vehicle**

Perform the following according to the driving conditions:

## 320 4-6. Driving tips

- Do not try to forcibly open a window or move a wiper that is frozen. Pour warm water over the frozen area to melt the ice. Wipe away the water immediately to prevent it from freezing.
- To ensure proper operation of the climate control system fan, remove any snow that has accumulated on the air inlet vents in front of the windshield.
- Check for and remove any excess ice or snow that may have accumulated on the exterior lights, vehicle's roof, chassis, around the tires or on the brakes.
- Remove any snow or mud from the bottom of your shoes before getting in the vehicle.

### When driving the vehicle

Accelerate the vehicle slowly, keep a safe distance between you and the vehicle ahead, and drive at a reduced speed suitable to road conditions.

### When parking the vehicle

- Park the vehicle and move the shift lever to P without setting the parking brake. The parking brake may freeze up, preventing it from being released. If the vehicle is parked without setting the parking brake, make sure to block the wheels. Failure to do so may be dangerous because it may cause the vehicle to move unexpectedly, possibly leading to an accident.
- When the parking brake is in automatic mode, release the parking brake after shifting the shift lever to P. (→P.209)
- If the vehicle is parked without setting the parking brake, confirm that the shift lever cannot be moved out of P\*.
- \*: The shift lever will be locked if it is attempted to be shifted from P to any other position without depressing the brake pedal. If the shift lever can be shifted from P, there may be a problem with the shift lock system. Have the vehicle inspected by your Toyota dealer immediately.

### Selecting tire chains

Use the correct tire chain size when mounting the tire chains. Chain size is regulated for each tire size.

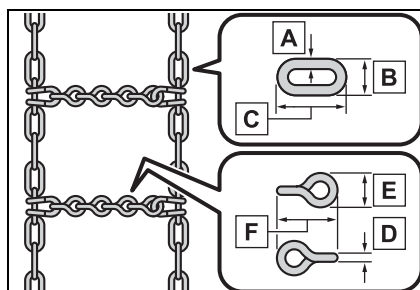



- A** Side chain (0.12 in. [3 mm] in diameter)
- B** Side chain (0.39 in. [10 mm] in width)
- C** Side chain (1.18 in. [30 mm] in length)
- D** Cross chain (0.16 in. [4 mm] in diameter)
- E** Cross chain (0.55 in. [14 mm] in width)
- F** Cross chain (0.98 in. [25 mm] in length)

**NOTICE****Fitting tire chains**

The tire pressure warning valves and transmitters may not function correctly when tire chains are fitted.

### Regulations on the use of tire chains

Regulations regarding the use of tire chains vary depending on location and type of road. Always check local regulations before installing chains.

#### ■ Tire chain installation

Observe the following precautions when installing and removing chains:

- Install and remove tire chains in a safe location.
- Install tire chains on the front tires only. Do not install tire chains on the rear tires.
- Install tire chains on front tires as tightly as possible. Retighten chains after driving 1/4—1/2 mile (0.5—1.0 km).
- Install tire chains following the instructions provided with the tire chains.

### Utility vehicle precautions

**This vehicle belongs to the utility vehicle class, which has higher ground clearance and narrower tread in relation to the height of its center of gravity.**

### Utility vehicle feature

- Specific design characteristics give it a higher center of gravity than ordinary passenger cars. This vehicle design feature causes this type of vehicle to be more likely to rollover. And, utility vehicles have a significantly higher rollover rate than other types of vehicles.
- An advantage of the higher ground clearance is a better view of the road allowing you to anticipate problems.
- It is not designed for cornering at the same speeds as ordinary passenger cars any more than low-slung sports cars are designed to perform satisfactorily under off-road conditions. Therefore, sharp turns at excessive speeds may cause the vehicle to roll over.

### WARNING

#### Utility vehicle precautions

Always observe the following precautions to minimize the risk of death, serious injury or damage to your vehicle:

- In a rollover crash, an unbelted person is significantly more likely to die than a person wearing a seat belt. Therefore, the driver and all passengers should always fasten their seat belts.
- Avoid sharp turns or abrupt maneuvers, if at all possible. Failure to operate this vehicle correctly may result in loss of control or vehicle rollover causing death or serious injury.
- Loading cargo on the roof luggage carrier (if equipped) will make the center of the vehicle gravity higher. Avoid high speeds, sudden starts, sharp turns, sudden braking or abrupt maneuvers, otherwise it may result in loss of control or vehicle rollover due to failure to operate this vehicle correctly.
- Always slow down in gusty crosswinds. Because of its profile and higher center of gravity, your vehicle is more sensitive to side winds than an ordinary passenger car. Slowing down will allow you to have better control.
- Do not drive horizontally across steep slopes. Driving straight up or straight down is preferred. Your vehicle (or any similar off-road vehicle) can tip over sideways much more easily than forward or backward.

**Off-road driving**

When driving your vehicle off-road, please observe the following precautions to ensure your driving enjoyment and to help prevent the closure of areas to off-road vehicles:

- Drive your vehicle only in areas where off-road vehicles are permitted to travel.
- Respect private property. Get owner's permission before entering private property.
- Do not enter areas that are closed. Honor gates, barriers and signs that restrict travel.
- Stay on established roads. When conditions are wet, driving techniques should be changed or travel delayed to prevent damage to roads.

---

**Additional information for off-road driving**

- ▶ For owners in U.S. mainland, Hawaii and Puerto Rico:

To obtain additional information pertaining to driving your vehicle off-road, consult the following organizations.

- State and Local Parks and Recreation Departments
- State Motor Vehicle Bureau
- Recreational Vehicle Clubs
- U.S. Forest Service and Bureau of Land Management

**⚠ WARNING****Off-road driving precautions**

Always observe the following precautions to minimize the risk of death, serious injury or damage to your vehicle:

- Drive carefully when off the road. Do not take unnecessary risks by driving in dangerous places.
- Do not grip the steering wheel spokes when driving off-road. A bad bump could jerk the wheel and injure your hands. Keep both hands and especially your thumbs on the outside of the rim.
- Always check your brakes for effectiveness immediately after driving in sand, mud, water or snow.
- After driving through tall grass, mud, rock, sand, rivers, etc., check that there is no grass, bush, paper, rags, stone, sand, etc. adhering or trapped on the underbody. Clear off any such matter from the underbody. If the vehicle is used with these materials trapped or adhering to the underbody, a breakdown or fire could occur.
- When driving off-road or in rugged terrain, do not drive at excessive speeds, jump, make sharp turns, strike objects, etc. This may cause loss of control or vehicle rollover causing death or serious injury. You are also risking expensive damage to your vehicle's suspension and chassis.



**NOTICE**

■ **To prevent water damage**

Take all necessary safety measures to ensure that water damage to the engine or other components does not occur.

- Water entering the engine air intake will cause severe engine damage.
- Water entering the automatic transmission will cause deterioration in shift quality, locking up of your transmission accompanied by vibration, and ultimately damage.
- Water can wash the grease from wheel bearings, causing rusting and premature failure, and may also enter the differential, transmission and transfer case, reducing the gear oil's lubricating qualities.

■ **When you drive through water**

If driving through water, such as when crossing shallow streams, first check the depth of the water and the bottom of the riverbed for firmness. Drive slowly and avoid deep water.

■ **Inspection after off-road driving**

- Sand and mud that has accumulated in brake drums and around brake discs may affect braking efficiency and may damage brake system components.
- Always perform a maintenance inspection after each day of off-road driving that has taken you through rough terrain, sand, mud, or water. For scheduled maintenance information, refer to the "Warranty and Services Guide".

## Interior features

### 5

- 5-1. Toyota multi-operation touch**  
 Toyota multi-operation touch ..... **326**
- 5-2. Using the air conditioning system and defogger**  
 Front manual air conditioning system ..... **328**  
 Front automatic air conditioning system ..... **333**  
 Rear manual air conditioning system ..... **346**  
 Rear automatic air conditioning system ..... **348**  
 Heated steering wheel/seat heaters/seat ventilators ..... **352**
- 5-3. Using the interior lights**  
 Interior lights list ..... **355**
- 5-4. Using the storage features**  
 List of storage features ..... **358**  
 Luggage compartment features ..... **363**
- 5-5. Using the other interior features**  
 Other interior features. **367**  
 Garage door opener.... **379**

**Toyota multi-operation touch\***

\*: Vehicle with the 12.3-inch display

**The Toyota multi-operation touch allows a screen, such as the air conditioning control screen, and the navigation screen to be displayed and operated simultaneously.**

**Toyota multi-operation touch overview**

The following functions can be displayed and operated on the Toyota multi-operation touch.

Operate a switch to change the displayed function screen.

The displayed function can also be changed by performing an up or down flick operation on the Toyota multi-operation touch.

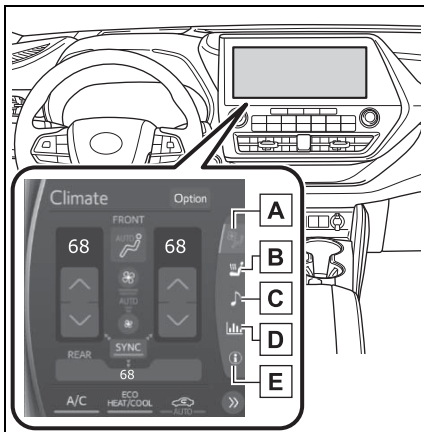

**A** Select to display the air conditioning control screen. (→P.340, 350)

**B** Select to display the seat control screen. (→P.353, 354)

**C** Select to display the audio control screen.\*

**D** Select to display the fuel consumption screen. (→P.106)

**E** 2WD models: Select to display the setting screen. (→P.327)

AWD models: Select to display the vehicle information screen. (→P.87)

\*: Refer to the “NAVIGATION AND MULTIMEDIA SYSTEM OWNER’S MANUAL”.

**Toyota multi-operation touch operation**

**■ Moving screens on the Toyota multi-operation touch**

Selecting << or >> to change its displayed position on the Toyota multi-operation touch.

The screen position can also be changed by perform a left or right flick operation on a screen.

**■ Displaying a screen in full screen**

Selecting < or > on the energy monitor/consumption screen or vehicle information screen will display that screen in full screen.

Select < or > to return to the

split-screen display.

### Toyota multi-operation touch settings

AWD models: Select “Setting” on the vehicle information screen to display the setting screen.

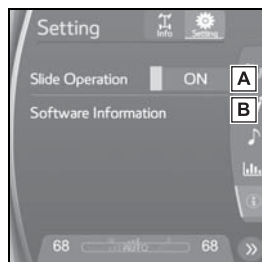

- A** Select slide operation on/off
- B** Display the software information

### Copyright

©1982-2013, QNX Software Systems Limited. All rights reserved.

**Front manual air conditioning system\***

\*: If equipped

**Air conditioning controls**

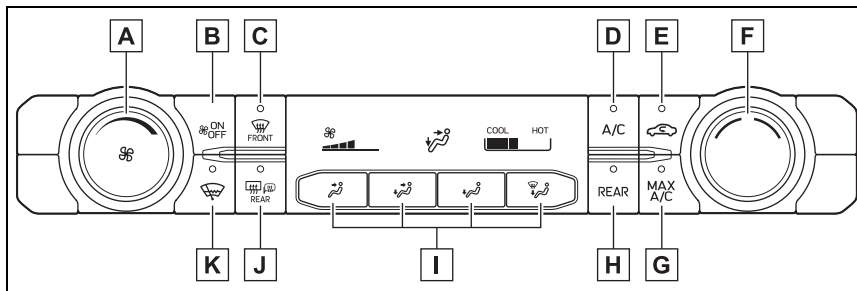

- A** Fan speed control switch
- B** On/off switch
- C** Windshield defogger switch
- D** "A/C" switch
- E** Outside/recirculated air mode switch
- F** Temperature control switch
- G** "MAX A/C" switch
- H** "REAR" switch

Press the switch to turn the rear air conditioning system on/off. (→P.346)  
 When the rear air conditioning system is on, the indicator illuminates on the "REAR" switch.

- I** Airflow mode control switch
- J** Rear window defogger and outside rear view mirror defoggers switch
- K** Windshield wiper de-icer switch

■ **Adjusting the temperature setting**

To adjust the temperature setting, turn the temperature control switch clockwise (warm) or counterclockwise (cool).

If "A/C" switch is not pressed, the

system will blow ambient temperature air or heated air.

■ **Fan speed setting**

To adjust the fan speed, turn the fan speed control switch clockwise (increase) or counterclockwise (decrease).



Pressing the on/off switch turns off the fan.

When the fan is off, pressing the on/off switch or turning the fan speed control switch will turn on the fan.

■ **Change the airflow mode**

Press the airflow mode control switch.

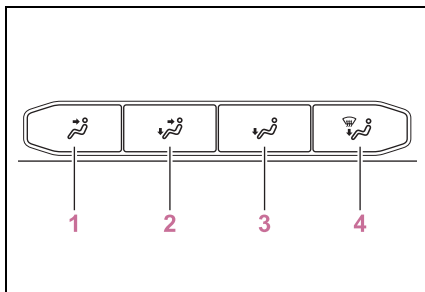

- 1 Upper body
- 2 Upper body and feet
- 3 Feet
- 4 Feet and the windshield defogger operates

■ **Switching between outside air and recirculated air modes**

Press the outside/recirculated air mode switch.

The mode switches between outside air mode and recirculated air mode each time the switch is operated.

When recirculated air mode is selected, the indicator illuminates on the outside/recirculated air mode switch.

■ **Set cooling and dehumidification function**

Press the “A/C” switch.

When the function is on, the indicator illuminates on the “A/C” switch.

■ **Defogging the windshield**

Defoggers are used to defog the windshield and front side windows.

Press the windshield defogger switch.

Set the outside/recirculated air mode switch to outside air mode if the recirculated air mode is used.

To defog the windshield and the side windows quickly, turn the air flow and temperature up.

To return to the previous mode, press the windshield defogger switch again when the windshield is defogged.

When the windshield defogger switch is on, the indicator illuminates on the windshield defogger switch.

■ **Defogging the rear window and outside rear view mirrors**

Defoggers are used to defog the rear window, and to remove raindrops, dew and frost from the outside rear view mirrors.

Press the rear window defogger and outside rear view mirror defoggers switch.

When the rear window defogger and outside rear view mirror defoggers switch is on, the indicator illu-

minates on the rear window defogger and outside rear view mirror defoggers switch.

The defoggers will automatically turn off after a while.

■ **Windshield wiper de-icer**

This feature is used to prevent ice from building up on the windshield and wiper blades.

Press the windshield wiper de-icer switch.

When the windshield wiper de-icer switch is on, the indicator illuminates on the windshield wiper de-icer switch.

The windshield wiper de-icer will automatically turn off after a period of time.

■ **For quick cooling**

Press the "MAX A/C" switch.

The air conditioning will automatically turn on.

At this time, the following will occur:

- The recirculated air mode will be set
- The windshield defogger will turn off
- The air flow mode will change to the upper body mode
- The fan speed will be set to high.

■ **Fogging up of the windows**

- The windows will easily fog up when the humidity in the vehicle is high. Turning the "A/C" switch on will dehumidify the air from the outlets and defog the windshield effectively.
- If you turn the "A/C" switch off, the windows may fog up more easily.
- The windows may fog up if the recirculated air mode is used.

■ **When driving on dusty roads**

Close all windows. If dust thrown up by the vehicle is still drawn into the vehicle after closing the windows, it is recommended that the air intake mode be set to outside air mode and the fan speed to any setting except off.

■ **Outside/recirculated air mode**

Setting to the recirculated air mode temporarily is recommended in preventing dirty air from entering the vehicle interior and helping to cool the vehicle when the outside air temperature is high.

■ **Operation of the air conditioning system in Eco drive mode**

In Eco drive mode, the air conditioning system is controlled to prioritize fuel efficiency by regulating the engine speed and compressor operation to restrict the heating/cooling capacity.

To improve air conditioning performance, perform the following operations:

- Adjust the fan speed
- Adjust the temperature setting
- Turn off Eco drive mode (→P.306)

■ **When the outside temperature is low**

The dehumidification function may not operate even when the "A/C" switch is pressed.

■ **Ventilation and air conditioning odors**

- To let fresh air in, set the air conditioning system to the outside air mode.
- During use, various odors from inside and outside the vehicle may enter into and accumulate in the air conditioning system. This may then cause odor to be emitted from the vents.
- To reduce potential odors from occurring: It is recommended that the air conditioning system be set

to outside air mode prior to turning the vehicle off.

- When parking, the system automatically switches to outside air mode to encourage better air circulation throughout the vehicle, helping to reduce odors that occur when starting the vehicle.

■ **Air conditioning filter**

→P.426

■ **Air conditioning system refrigerant**

- A label regarding the refrigerant of the air conditioning system is attached to the hood at the location shown in the following illustration.

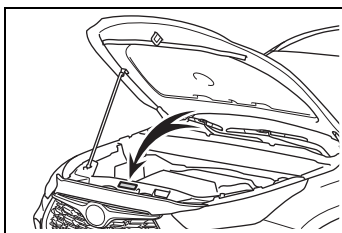

- The meaning of each symbol on the label are as follows:

	Caution
	Air conditioning system
	Air conditioning system lubricant type
	Requires registered technician to service air conditioning system
	Flammable refrigerant

**! WARNING**

■ **To prevent the windshield from fogging up**

Do not use the windshield defogger switch during cool air operation in extremely humid weather. The difference between the temperature of the outside air and that of the windshield can cause the outer surface of the windshield to fog up, blocking your vision.

■ **When the outside rear view mirror defoggers are operating**

Do not touch the rear view mirror surfaces when the outside rear view mirror defoggers are on.

■ **When the windshield wiper de-icer is operating**

Do not touch the glass at lower part of the windshield or to the side of the front pillars when the windshield wiper de-icer is on.

**! NOTICE**

■ **To prevent battery discharge**

Do not leave the air conditioning system on longer than necessary when the engine is off.

■ **When repairing/replacing parts of the air conditioning system**

Have repair/replacement performed by your Toyota dealer. When a part of the air conditioning system, such as the evaporator, is to be replaced, it must be replaced with a new one.

**Air outlet layout and operations**

■ **Location of air outlets**

The air outlets and air volume change according to the selected airflow mode.

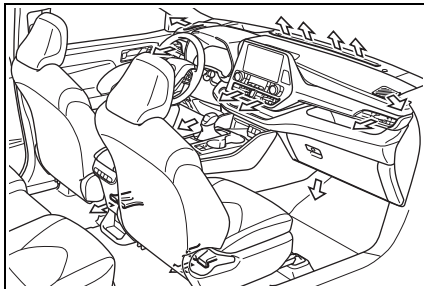

■ **Adjusting the air flow direction and opening/closing the air outlets**

► **Front center outlets**

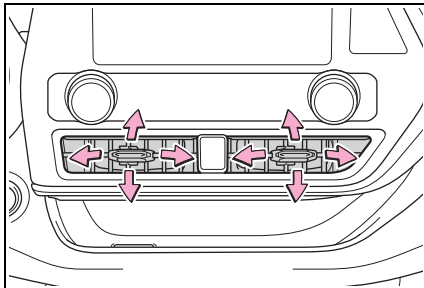

Direct air flow to the left or right, up or down

► **Front side outlets**

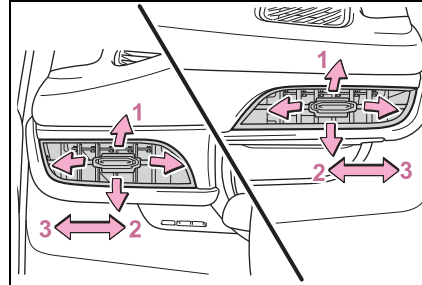

- 1 Direct air flow to the left or right, up or down
- 2 Open the vent
- 3 Close the vent

**⚠ WARNING**

■ **To not interrupt the windshield defogger from operating**

Do not place anything on the instrument panel which may cover the air outlets. Otherwise, air flow may be obstructed, preventing the windshield defoggers from defogging.

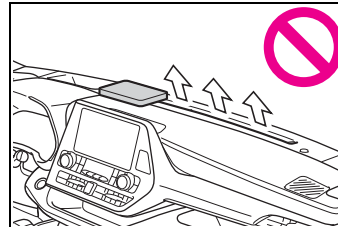

### Front automatic air conditioning system\*

\*: If equipped

**Air outlets and fan speed are automatically adjusted according to the temperature setting.**

**Vehicles with a 12.3-inch display: The air conditioning system can be displayed and operated on the toyota multi-operation touch.**

### Air conditioning controls (vehicle with a 8-inch display)

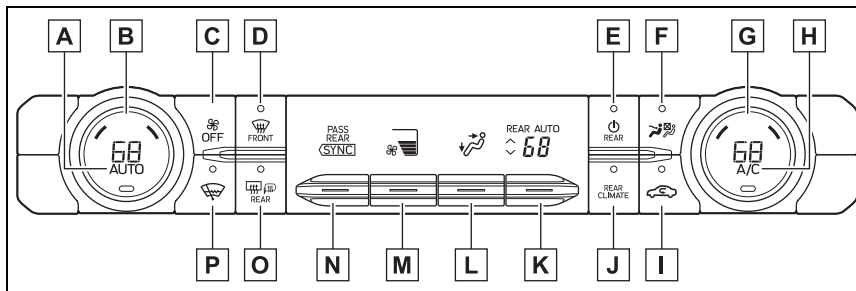

- A** Automatic mode switch (→P.342)
- B** Left-hand side temperature control switch
- C** “OFF” switch
- D** Windshield defogger switch
- E** Rear air conditioning system on/off switch (→P.349)
- F** S-FLOW mode switch (→P.342)
- G** Right-hand side temperature control switch
- H** “A/C” switch
- I** Outside/recirculated air mode switch
- J** “REAR CLIMATE” switch (→P.349)
- K** Rear seat temperature control knob (→P.349)
- L** Airflow mode control knob
- M** Fan speed control knob
- N** “SYNC” control knob
- O** Rear window defogger and outside rear view mirror defoggers

switch

**P** Windshield wiper de-icer switch

■ **Adjusting the temperature setting**

Turn driver's side temperature control switch clockwise to increases the temperature and turn the switch counterclockwise to decreases the temperature.

If "A/C" switch is not pressed, the system will blow ambient temperature air or heated air.

The temperature for the driver, front passenger and rear seats can be adjusted separately when:

- "SYNC" control knob is moved upward or downward. (The "PASS" and "REAR" displays disappear)
- The passenger's side temperature control switch is turned. (The "PASS" display disappears)
- The rear seat temperature control knob is moved upward or downward. (The "REAR" display disappears)

To the air conditioning system switches between individual and simultaneous modes move "SYNC" control knob upward or downward.

■ **Setting the fan speed**

To set the fan speed, move the fan speed control knob upward or downward.

Upward: Increases the fan speed

Downward: Decreases the fan speed

Pressing the "OFF" switch to turns off the fan.

■ **Change the airflow mode**

To change the airflow mode, move the airflow mode control knob upward or downward.

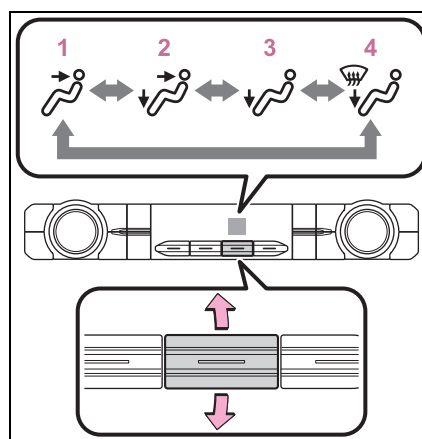

- 1** Upper body
- 2** Upper body and feet
- 3** Feet
- 4** Feet and the windshield defogger operates

■ **Switching between outside air and recirculated air modes**

Press the outside/recirculated air mode switch.

The mode switches between outside air mode and recirculated air mode each time the switch is operated.

When recirculated air mode is

selected, the indicator illuminates on the outside/recirculated air mode switch.

#### ■ **Set cooling and dehumidification function**

Press the "A/C" switch.

When the function is on, the indicator illuminates on the "A/C" switch.

#### ■ **Defogging the windshield**

Defoggers are used to defog the windshield and front side windows.

Press the windshield defogger switch.

Set the outside/recirculated air mode switch to outside air mode if the recirculated air mode is used. (It may switch automatically.)

To defog the windshield and the side windows quickly, turn the air flow and temperature up.

To return to the previous mode, press the windshield defogger switch again when the windshield is defogged.

When the windshield defogger switch is on, the indicator illuminates on the windshield defogger switch.

#### ■ **Defogging the rear window and outside rear view mirrors**

Defoggers are used to defog the rear window and to remove raindrops, dew and frost from the outside rear view mirrors.

Press the rear window defogger and outside rear view mirror

defoggers switch.

When the rear window defogger and outside rear view mirror defoggers switch is on, the indicator illuminates on the rear window defogger and outside rear view mirror defoggers switch.

The defoggers will automatically turn off after a while.

#### ■ **Windshield wiper de-icer**

This feature is used to prevent ice from building up on the windshield and wiper blades.

Press the windshield wiper de-icer switch.

When the windshield wiper de-icer switch is on, the indicator illuminates on the windshield wiper de-icer switch.

The windshield wiper de-icer will automatically turn off after a period of time.

#### ■ **When the outside temperature exceeds 75°F (24°C) and the air conditioning system is on**

- In order to reduce the air conditioning power consumption, the air conditioning system may switch to recirculated air mode automatically. This may also reduce fuel consumption.
- Recirculated air mode is selected as a default mode when the engine switch is turned to ON.
- It is possible to switch to outside air mode at any time by pressing the outside air mode switch.

#### ■ **Fogging up of the windows**

- The windows will easily fog up when the humidity in the vehicle is high. Turning "A/C" on will dehumidify the air from the outlets and

defog the windshield effectively.

- If you turn "A/C" off, the windows may fog up more easily.
- The windows may fog up if the recirculated air mode is used.

■ **When driving on dusty roads**

Close all windows. If dust thrown up by the vehicle is still drawn into the vehicle after closing the windows, it is recommended that the air intake mode be set to outside air mode and the fan speed to any setting except off.

■ **Outside/recirculated air mode**

- Setting to the recirculated air mode temporarily is recommended in preventing dirty air from entering the vehicle interior and helping to cool the vehicle when the outside air temperature is high.
- Outside/recirculated air mode may automatically switch depending on the temperature setting or the inside temperature.

■ **Operation of the air conditioning system in Eco drive mode**

- In Eco drive mode, the air conditioning system is controlled as follows to prioritize fuel efficiency:
  - Engine speed and compressor operation controlled to restrict heating/cooling capacity
  - Fan speed restricted when automatic mode is selected
- To improve air conditioning performance, perform the following operations:
  - Adjust the fan speed
  - Turn off Eco drive mode (→P.306)

■ **When the outside temperature is low**

The dehumidification function may not operate even when the "A/C" switch is pressed.

■ **Ventilation and air conditioning odors**

- To let fresh air in, set the air condi-

tioning system to the outside air mode.

- During use, various odors from inside and outside the vehicle may enter into and accumulate in the air conditioning system. This may then cause odor to be emitted from the vents.
- To reduce potential odors from occurring:
  - It is recommended that the air conditioning system be set to outside air mode prior to turning the vehicle off.
  - The start timing of the blower may be delayed for a short period of time immediately after the air conditioning system is started in automatic mode.
- When parking, the system automatically switches to outside air mode to encourage better air circulation throughout the vehicle, helping to reduce odors that occur when starting the vehicle.

■ **Air conditioning system operations when the engine is stopped due to the Stop & Start system (vehicles with Stop & Start system)**

When the engine is stopped due to Stop & Start system operations, the automatic air conditioning cooling, heating and dehumidification functions turn off and the fan speed is decreased according to the outside temperature etc. or air blowing stops. To stop the air conditioning system from turning off, press the Stop & Start cancel switch and refrain from using the Stop & Start system.

■ **When the windshield is fogged up and the engine is stopped due to the Stop & Start system (vehicles with Stop & Start system)**

Press the windshield defogger switch to restart the engine and defog the windshield.

If the windshield continuously fogs



up, press the Stop & Start cancel switch and refrain from using the Stop & Start system.

■ **When an odor comes from the air conditioning system while the engine is stopped due to the Stop & Start system (vehicles with Stop & Start system)**

Press the Stop & Start cancel switch to restart the engine.

■ **Air conditioning filter**

→P.426

■ **Air conditioning system refrigerant**

- A label regarding the refrigerant of the air conditioning system is attached to the hood at the location shown in the following illustration.

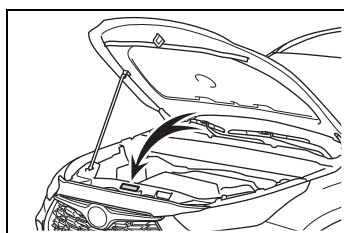

- The meaning of each symbol on the label are as follows:

	Caution
	Air conditioning system
	Air conditioning system lubricant type
	Requires registered technician to service air conditioning system
	Flammable refrigerant

■ **Customization**

Some functions can be customized. (→P.515)

**WARNING**

■ **To prevent the windshield from fogging up**

Do not use the windshield defogger switch during cool air operation in extremely humid weather. The difference between the temperature of the outside air and that of the windshield can cause the outer surface of the windshield to fog up, blocking your vision.

■ **When the outside rear view mirror defoggers are operating**

Do not touch the rear view mirror surfaces when the outside rear view mirror defoggers are on.

■ **When the windshield wiper de-icer is operating**

Do not touch the glass at lower part of the windshield or to the side of the front pillars when the windshield wiper de-icer is on.

**NOTICE**

■ **To prevent battery discharge**

Do not leave the air conditioning system on longer than necessary when the engine is off.

■ **When repairing/replacing parts of the air conditioning system**

Have repair/replacement performed by your Toyota dealer. When a part of the air conditioning system, such as the evaporator, is to be replaced, it must be replaced with a new one.

**Air conditioning controls (vehicle with a 12.3-inch display)**

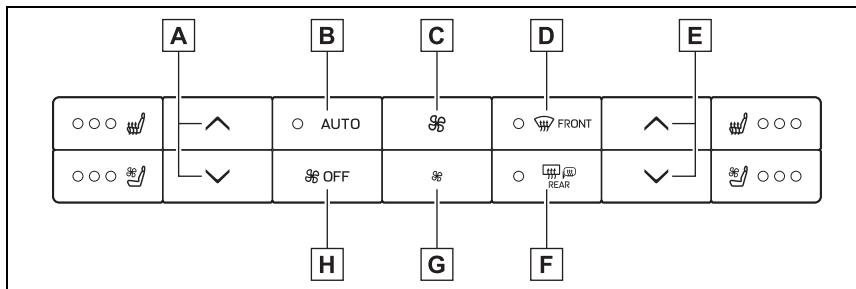

- A** Left-hand side temperature control switch
- B** Automatic mode switch (→P.342)
- C** Fan speed increase switch
- D** Windshield defogger switch
- E** Right-hand side temperature control switch
- F** Rear window defogger and outside rear view mirror defoggers switch
- G** Fan speed decrease switch
- H** “OFF” switch

■ **Adjusting the temperature setting**

Press  to increase the temperature and  to decrease the temperature.

If “A/C” switch is not pressed, the system will blow ambient temperature air or heated air.

■ **Setting the fan speed**

Operate the  switch to increase the fan speed and the  switch to decrease the fan speed.

Pressing the “OFF” switch to turns off the fan.

■ **Defogging the windshield**

Defoggers are used to defog the windshield and front side windows.

Press the windshield defogger switch.

Set the outside/recirculated air mode switch to outside air mode if the recirculated air mode is used. (It may switch automatically.)

To defog the windshield and the side windows quickly, turn the air flow and temperature up.

To return to the previous mode, press the windshield defogger switch again when the windshield is defogged.

When the windshield defogger switch is on, the indicator illuminates on the windshield defogger switch.

■ **Defogging the rear window and outside rear view mirrors**

Defoggers are used to defog the rear window and to remove raindrops, dew and frost from the outside rear view mirrors.

Press the rear window defogger and outside rear view mirror defoggers switch.

When the rear window defogger and outside rear view mirror defoggers switch is on, the indicator illuminates on the rear window defogger and outside rear view mirror defoggers switch.

The defoggers will automatically turn off after a while.

■ **Air conditioning system operations when the engine is stopped due to the Stop & Start system**

When the engine is stopped due to Stop & Start system operations, the automatic air conditioning cooling, heating and dehumidification functions turn off and the fan speed is decreased according to the outside temperature etc. or air blowing stops. To stop the air conditioning system from turning off, press the Stop & Start cancel switch and refrain from using the Stop & Start system.

■ **When the windshield is fogged up and the engine is stopped due to the Stop & Start system**

Press the windshield defogger switch to restart the engine and

defog the windshield.

If the windshield continuously fogs up, press the Stop & Start cancel switch and refrain from using the Stop & Start system.

■ **When an odor comes from the air conditioning system while the engine is stopped due to the Stop & Start system**

Press the Stop & Start cancel switch to restart the engine.

■ **Air conditioning filter**

→P.426

■ **Air conditioning system refrigerant**

- A label regarding the refrigerant of the air conditioning system is attached to the hood at the location shown in the following illustration.

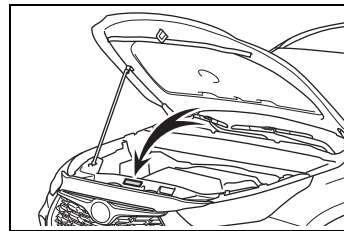

- The meaning of each symbol on the label are as follows:

	Caution
	Air conditioning system
	Air conditioning system lubricant type
	Requires registered technician to service air conditioning system
	Flammable refrigerant

■ Customization

Some functions can be customized. (→P.515)

**⚠ WARNING**

■ To prevent the windshield from fogging up

Do not use the windshield defogger switch during cool air operation in extremely humid weather. The difference between the temperature of the outside air and that of the windshield can cause the outer surface of the windshield to fog up, blocking your vision.

■ When the outside rear view mirror defoggers are operating

Do not touch the rear view mirror surfaces when the outside rear view mirror defoggers are on.

**⚠ NOTICE**

■ To prevent battery discharge

Do not leave the air conditioning system on longer than necessary when the engine is off.

■ When repairing/replacing parts of the air conditioning system

Have repair/replacement performed by your Toyota dealer. When a part of the air conditioning system, such as the evaporator, is to be replaced, it must be replaced with a new one.

**Front air conditioning control screen (vehicle with a 12.3-inch display)**

■ Main control screen

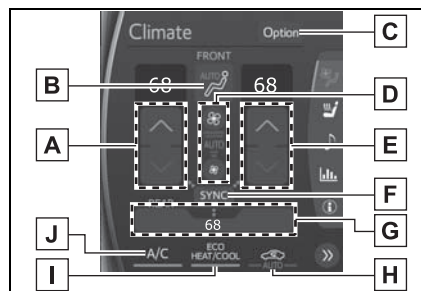

**A** Adjust the left side seat temperature setting

**B** Select the air flow mode

↗ : Air flows to the upper body

↗↘ : Air flows to the upper body and feet

↘ : Air flows to the feet

↘↗ : Air flows to the feet and the windshield defogger operates

**C** Display the option control screen.

**D** Adjust the fan speed setting

**E** Adjust the right side seat temperature setting

**F** “SYNC” switch

If the indicator on the “SYNC” switch is off, the temperature for the driver, passenger and rear seats can be adjusted separately.

**G** Display the rear air conditioning control screen (→P.350)

**H** Select the outside air and recirculated air modes

**I** Set eco air conditioning mode

The air conditioning is controlled with low fuel consumption prioritized such as reducing fan speed, etc.

**J** Set cooling and dehumidification function

If "A/C" switch is not pressed, the system will blow ambient temperature air or heated air.

■ **Option control screen**

Select "Option" to display the option control screen.

The functions can be switched on and off.

When the function is on, the indicator illuminates on the screen.



**A** Select to display the previous screen.

**B** Select the S-FLOW mode (→P.342)

■ **When the outside temperature exceeds 75°F (24°C) and the air conditioning system is on**

- In order to reduce the air conditioning power consumption, the air conditioning system may switch to recirculated air mode automatically. This may also reduce fuel consumption.

- Recirculated air mode is selected as a default mode when the engine switch is turned to ON.

- It is possible to switch to outside air mode at any time by pressing the outside air mode switch.

■ **Fogging up of the windows**

- The windows will easily fog up when the humidity in the vehicle is high. Turning "A/C" on will dehumidify the air from the outlets and defog the windshield effectively.

- If you turn "A/C" off, the windows may fog up more easily.

- The windows may fog up if the recirculated air mode is used.

■ **When driving on dusty roads**

Close all windows. If dust thrown up by the vehicle is still drawn into the vehicle after closing the windows, it is recommended that the air intake mode be set to outside air mode and the fan speed to any setting except off.

■ **Outside/recirculated air mode**

- Setting to the recirculated air mode temporarily is recommended in preventing dirty air from entering the vehicle interior and helping to cool the vehicle when the outside air temperature is high.

- Outside/recirculated air mode may automatically switch depending on the temperature setting or the inside temperature.

■ **Eco air conditioning mode**

When Eco drive mode is selected using the driving mode select switch, eco air conditioning mode turns on.

When a drive mode other than Eco drive mode is selected, eco air conditioning mode may turn off.

■ **Operation of the air conditioning system in Eco drive mode**

- In Eco drive mode, the air condi-

tioning system is controlled as follows to prioritize fuel efficiency:

- Engine speed and compressor operation controlled to restrict heating/cooling capacity
- Fan speed restricted when automatic mode is selected
- To improve air conditioning performance, perform the following operations:
  - Adjust the fan speed
  - Turn off Eco drive mode (P.306)
  - Turn off Eco air conditioning mode
- When the driving mode is set to Eco driving mode, the air conditioning eco mode will be turned on automatically. Even in this case, the air conditioning eco mode can be turned off by pressing the Eco air conditioning mode switch.

■ **When the outside temperature is low**

The dehumidification function may not operate even when "A/C" is pressed.

■ **Ventilation and air conditioning odors**

- To let fresh air in, set the air conditioning system to the outside air mode.
- During use, various odors from inside and outside the vehicle may enter into and accumulate in the air conditioning system. This may then cause odor to be emitted from the vents.
- To reduce potential odors from occurring:
  - It is recommended that the air conditioning system be set to outside air mode prior to turning the vehicle off.
  - The start timing of the blower may be delayed for a short period of time immediately after the air conditioning system is started in automatic mode.
- When parking, the system automatically switches to outside air mode to encourage better air cir-

ulation throughout the vehicle, helping to reduce odors that occur when starting the vehicle.

**Using automatic mode**

- 1** Press the automatic mode switch.

The dehumidification function begins to operate. Air outlets and fan speed are automatically adjusted according to the temperature setting and humidity.

- 2** Adjust the temperature setting.
- 3** To stop the operation, press the "OFF" switch.

If the fan speed setting or air flow modes are operated, the automatic mode indicator goes off. However, automatic mode for functions other than that operated is maintained.

■ **Using automatic mode**

Fan speed is adjusted automatically according to the temperature setting and the ambient conditions. Therefore, the fan may stop for a while until warm or cool air is ready to flow immediately after the automatic mode switch is pressed.

**Front seat concentrated airflow mode (S-FLOW)**

This function automatically controls the air conditioning airflow so that priority is given to the front seats. When the front passenger seat is not occupied, airflow may switch to only the driver's seat. Unnecessary air

conditioning is suppressed, contributing to increased fuel efficiency.

Front seat concentrated airflow mode operates in the following situations.

- No passengers are detected in the rear seats
- The windshield defogger is not operating

While operating, the indicator illuminates on the S-FLOW mode switch.

■ **Manually turning front seat concentrated airflow mode on/off**

In front seat concentrated airflow mode, directing airflow to the front seats only and to all seats can be switched via switch operation. When the mode has been switched manually, automatic airflow control stops operating.

Select  on the option control screen or press the S-FLOW mode switch on the air conditioning operation panel and switch the airflow.

- Indicator illuminated: Airflow to the front seats only
- Indicator off: Airflow to all the seats

■ **Operation of automatic airflow control**

- In order to maintain a comfortable interior, airflow may be directed to seats without passengers immedi-

ately after the engine is started and at other times depending on the outside temperature.

- After the engine is started, if passengers move around inside or enter/exit the vehicle, the system cannot accurately detect the presence of passengers and automatic airflow control will not operate.

■ **Operation of manual airflow control**

Even if the function is manually switched to directing airflow to only the front seats, when a rear seat is occupied, it may automatically direct airflow to all seats.

■ **To return to automatic airflow control**

- 1 With the indicator off, turn the engine switch off.
- 2 After 60 minutes or more elapse, turn the engine switch to ON.

**Windshield wiper de-icer (vehicle with a 12.3-inch display)**

This feature is used to prevent ice from building up on the windshield and wiper blades.

Press the switch to turn the system on/off.

The indicator comes on when the system is on.

The windshield wiper de-icer will automatically turn off after a period of time.

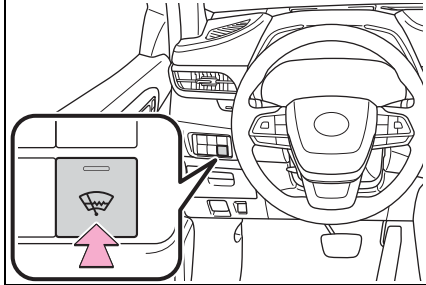

**⚠ WARNING**

■ **To prevent burns**

Do not touch the glass at lower part of the windshield or to the side of the front pillars when the windshield wiper deicer is on.

**Air outlet layout and operations**

■ **Location of air outlets**

The air outlets and air volume change according to the selected air flow mode.

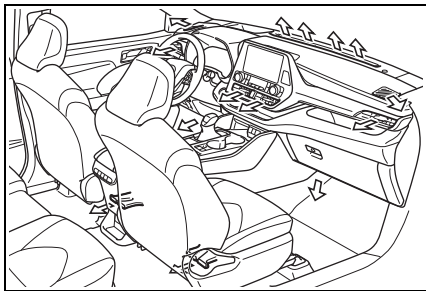

■ **Adjusting the air flow direction and opening/closing the air outlets**

▶ **Front center outlets**

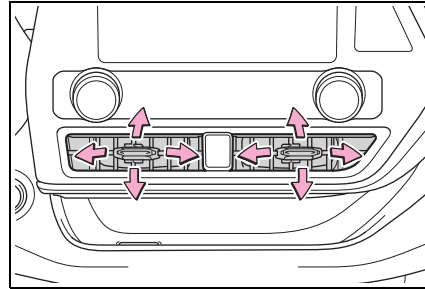

Direct air flow to the left or right, up or down

▶ **Front side outlets**

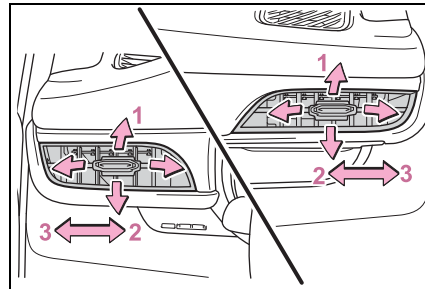

- 1 Direct air flow to the left or right, up or down
- 2 Open the vent
- 3 Close the vent



**⚠ WARNING****■ To not interrupt the windshield defogger from operating**

Do not place anything on the instrument panel which may cover the air outlets. Otherwise, air flow may be obstructed, preventing the windshield defoggers from defogging.

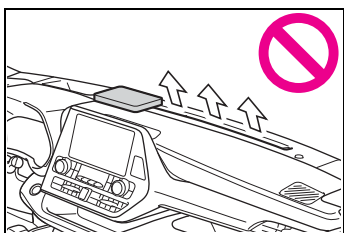

### Rear manual air conditioning system\*

\*: If equipped

#### Air conditioning controls

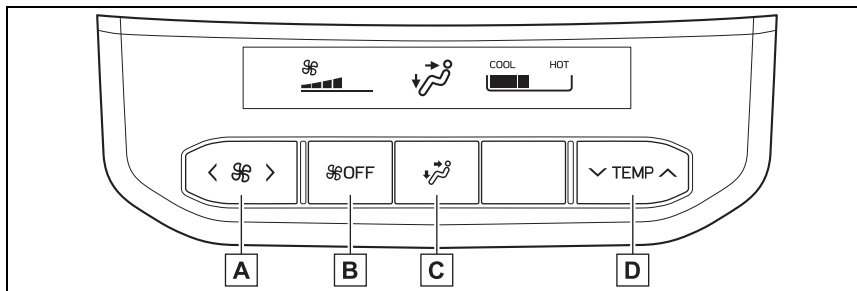

**A** Adjust the rear seats fan speed setting

Press to increase the fan speed and to decrease the fan speed.

**B** “OFF” switch

Pressing the “OFF” switch to turns off the fan.

**C** Airflow mode control switch

**D** Adjust the rear seats temperature setting

Press to increase the temperature and to decrease the temperature.

#### Change the airflow mode

To change the airflow mode, press the airflow mode control switch.

The air outlets used are switched each time the switch is pressed.

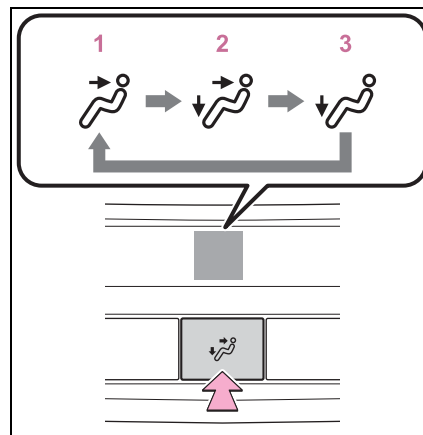

**1** Upper body

- 2** Upper body and feet
- 3** Feet

### Air outlets

#### ■ Location of air outlets

The air outlets and air volume changes according to the selected air flow mode.

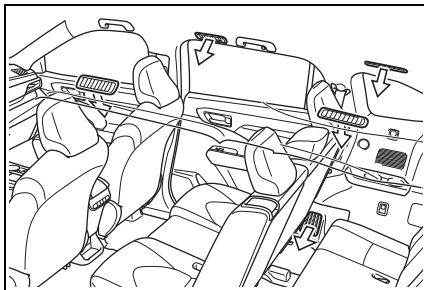

#### ■ Adjusting the position of and opening and closing the air outlets

Adjusting the position of and opening and closing the air outlets

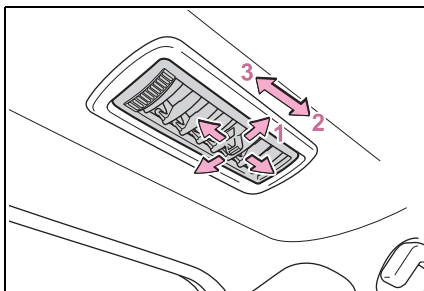

- 1** Direct air flow to the left or right, up or down
- 2** Open the vent
- 3** Close the vent

 NOTICE

**■ To prevent battery discharge**  
Do not leave the air conditioning system on longer than necessary when the engine is off.

### Rear automatic air conditioning system\*

\*: If equipped

The air outlets and fan speed are automatically adjusted according to the temperature setting.

**Vehicles with a 8-inch display:** The rear air conditioning system can be operated using the front air conditioning control panel and rear air conditioning control panel. Press the “REAR CLIMATE” switch on the front air conditioning control panel to change the rear air conditioning control mode.

**Vehicles with a 12.3-inch display:** The rear air conditioning system can be operated using the toyota multi-operation touch and rear air conditioning control panel. Select “REAR” on the front air conditioning control screen to display the rear air conditioning control screen.

### Rear air conditioning control operation

#### ■ Rear air conditioning control panel

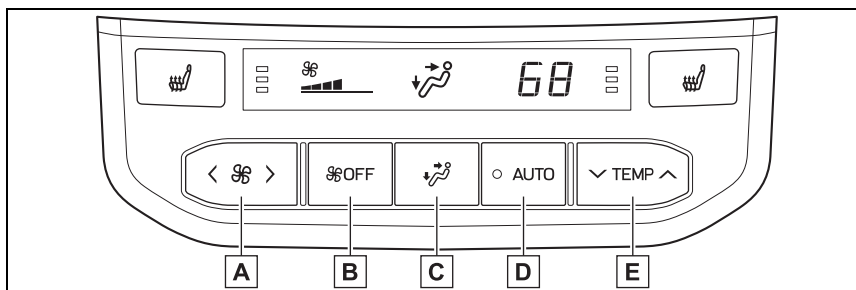

**A** Adjust the rear seats fan speed setting

Press to increase the fan speed and to decrease the fan speed.

**B** “OFF” switch



Pressing the “OFF” switch to turns off the fan.

**C** Air flow mode control switch

**D** Automatic mode switch

When the function is on, the indicator illuminates on the control screen.

**E** Adjust the rear seats temperature setting

Press  to increase the temperature and  to decrease the temperature.

■ **Front air conditioning control panel (vehicle with a 8-inch display)**

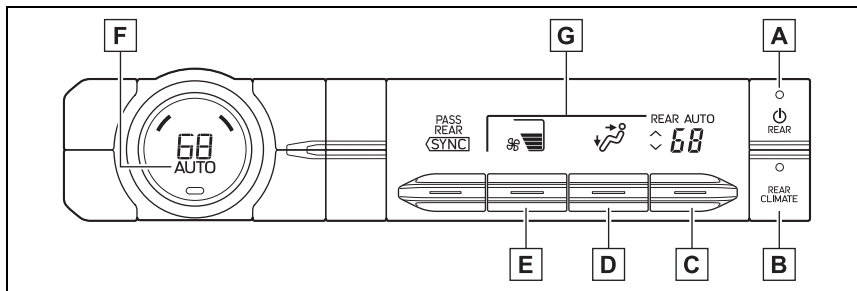

**A** Rear air conditioning system on/off switch

**B** “REAR CLIMATE” switch

The mode switches between the rear air conditioning control mode and front air conditioning control mode each time the “REAR CLIMATE” switch is pressed.

**C** Rear seat temperature control knob

To set temperature, move the rear seat temperature control knob upward or downward.

Upward: Increases the temperature

Downward: Decreases the temperature

**D** Airflow mode control knob

The airflow mode control knob can be operated while the rear air conditioning control indicator is appeared.

**E** Adjust the rear seats fan speed setting

Rear seats fan speed setting can be adjusted while the rear air conditioning control indicator is appeared.

To set the fan speed, move the fan speed control knob upward or downward.

Upward: Increases the fan speed

Downward: Decreases the fan speed

**F** Automatic mode switch (→P.351)

The automatic mode switch can be operated when the rear air conditioning control indicator is displayed.

**G** Rear air conditioning control indicator

When the “REAR CLIMATE” switch is pressed, the rear air conditioning

control indicator is displayed for several seconds.

■ **Rear air conditioning control screen (vehicle with a 12.3-inch display)**

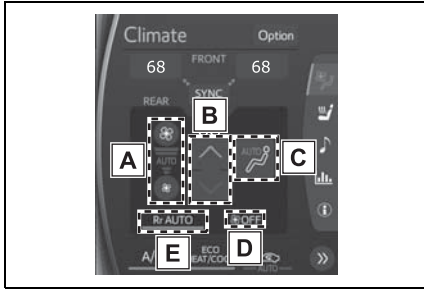

- A** Adjust the rear seats fan speed setting
  - B** Adjust the rear seats temperature setting
  - C** Air flow mode control switch
  - D** “OFF” switch
- Pressing the “OFF” switch to turns off the fan.
- E** Automatic mode switch

**Change the airflow mode**

■ **Rear air conditioning control panel**

To change the airflow mode, press the airflow mode control switch.

The air outlets used are switched each time the switch is pressed.

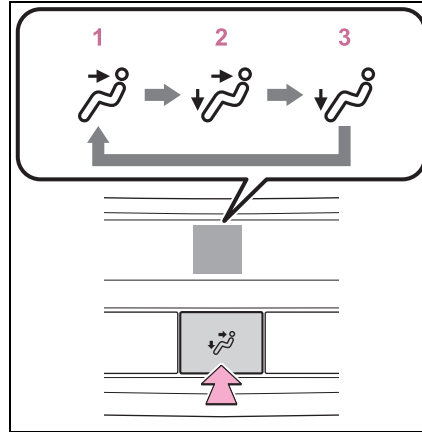

- 1** Upper body
- 2** Upper body and feet
- 3** Feet

■ **Front air conditioning control panel (vehicle with a 8-inch display)**

To change the airflow mode, move the airflow mode control knob upward or downward.

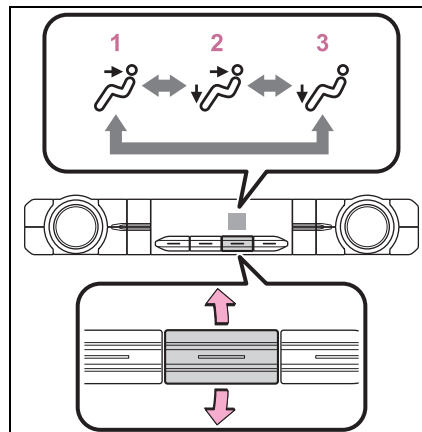



- 1** Upper body
- 2** Upper body and feet
- 3** Feet

### ■ Rear air conditioning control screen (vehicle with a 12.3-inch display)

To change the airflow mode, select the airflow mode control switch.

The air outlets used are switched each time the switch is selected.

 : Air flows to the upper body

 : Air flows to the upper body and feet

 : Air flows to the feet

### Using automatic mode

- 1 Press the automatic mode switch.
- 2 Adjust the temperature setting.
- 3 To stop the operation, press the “OFF” switch.

If the fan speed setting or air flow modes are operated, the automatic mode indicator goes off. However, automatic mode for functions other than that operated is maintained.

### ■ Using automatic mode

Fan speed is adjusted automatically according to the temperature setting and the ambient conditions.

Therefore, the fan may stop for a while until warm or cool air is ready to flow immediately after the automatic mode switch is pressed.

### Air outlets

#### ■ Location of air outlets

The air outlets and air volume changes according to the selected air flow mode.

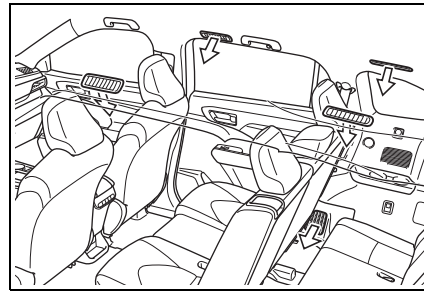

#### ■ Adjusting the position of and opening and closing the air outlets

Adjusting the position of and opening and closing the air outlets

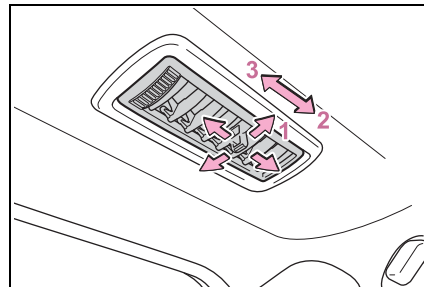

- 1 Direct air flow to the left or right, up or down
- 2 Open the vent
- 3 Close the vent

#### NOTICE

#### ■ To prevent battery discharge

Do not leave the air conditioning system on longer than necessary when the engine is off.

**Heated steering wheel\* / seat heaters\* / seat ventilators\***

\*: If equipped

- Heated steering wheel  
Warms up the grip of the steering wheel
- Seat heaters  
Warm up the seat upholstery
- Seat ventilators  
Maintain good ventilation using a fan built into the seat

**⚠ WARNING**

■ **To prevent minor burn injuries**

Care should be taken if anyone in the following categories comes in contact with the steering wheel or seats when the heater is on:

- Babies, small children, the elderly, the sick and the physically challenged
- Persons with sensitive skin
- Persons who are fatigued
- Persons who have taken alcohol or drugs that induce sleep (sleeping drugs, cold remedies, etc.)

**⚠ NOTICE**

■ **To prevent damage to the seat heaters**

Do not put heavy objects that have an uneven surface on the seat and do not stick sharp objects (needles, nails, etc.) into the seat.

■ **To prevent battery discharge**

Do not use the functions when the engine is off.

**Heated steering wheel**

Turns the heated steering wheel on/off

The indicator light comes on when the heated steering wheel is operating.

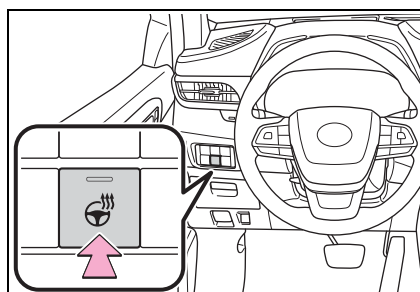

■ **Operation condition**

The engine switch is in ON.

■ **Timer function**

The heated steering wheel will automatically turn off after a period of time.

**Seat heaters**

■ **Front (Front air conditioning control panel)**

Each time the switch is pressed, the operation condition changes as follows.

Hi (3 segments lit) → Mid (2 segments lit) → Lo (1 segment lit) → Off

The level indicator (amber) **A** lights up during operation.



- ▶ Vehicle with a 12.3-inch display

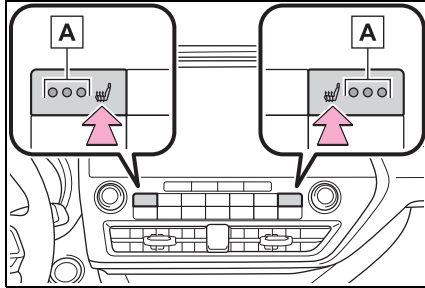

- ▶ Vehicle with an 8-inch display

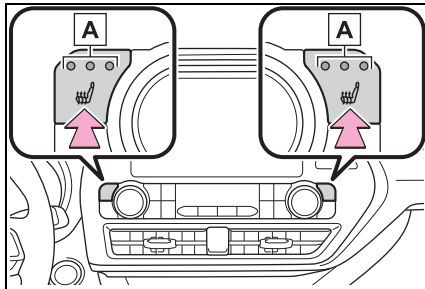

■ **Front (Toyota multi-operation touch: Vehicle with a 12.3-inch display)**

Select to display the seats climate screen.

Each time the switch is selected, the operation condition changes as follows.

Hi (3 segments lit)→Mid (2 segments lit)→Lo (1 segment lit)→Off

The level indicator (red) **A** lights up during operation.

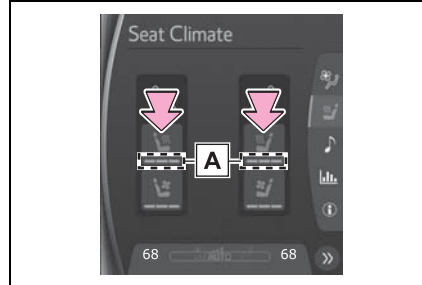

■ **Rear**

Each time the switch is pressed, the operation condition changes as follows.

Hi (3 segments lit)→Mid (2 segments lit)→Lo (1 segment lit)→Off

The level indicator (amber) **A** lights up during operation.

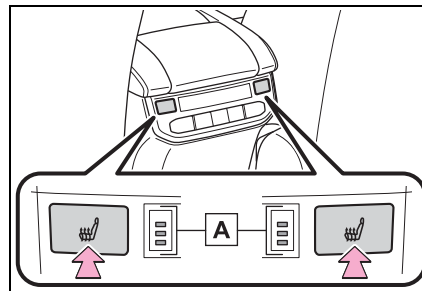

■ **Operation condition**

The engine switch is in ON.

**⚠ WARNING**

■ **To prevent overheating and minor burn injuries**

Observe the following precautions when using the seat heaters.

- Do not cover the seat with a blanket or cushion when using the seat heater.

**⚠ WARNING**  
 ● Do not use seat heater more than necessary.

**Seat ventilators**

■ **Front air conditioning control panel**

Each time the switch is pressed, the operation condition changes as follows.  
 Hi (3 segments lit)→Mid (2 segments lit)→Lo (1 segment lit)→Off

The level indicator (green) **A** lights up during operation.

▶ Vehicle with a 12.3-inch display

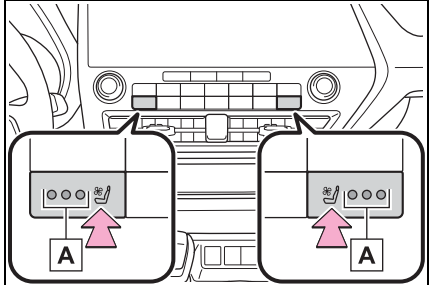

▶ Vehicle with a 8-inch display

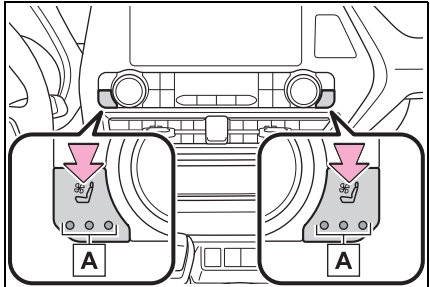

■ **Toyota multi-operation touch (Vehicle with a 12.3-inch display)**

Select to display the seat climate screen.

Each time the switch is selected, the operation condition changes as follows.

Hi (3 segments lit)→Mid (2 segments lit)→Lo (1 segment lit)→Off

The level indicator (blue) **A** lights up during operation.

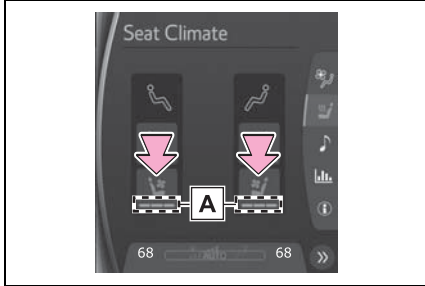

■ **Operation condition**

The engine switch is in ON.

**Interior lights list**

**Location of the interior lights**

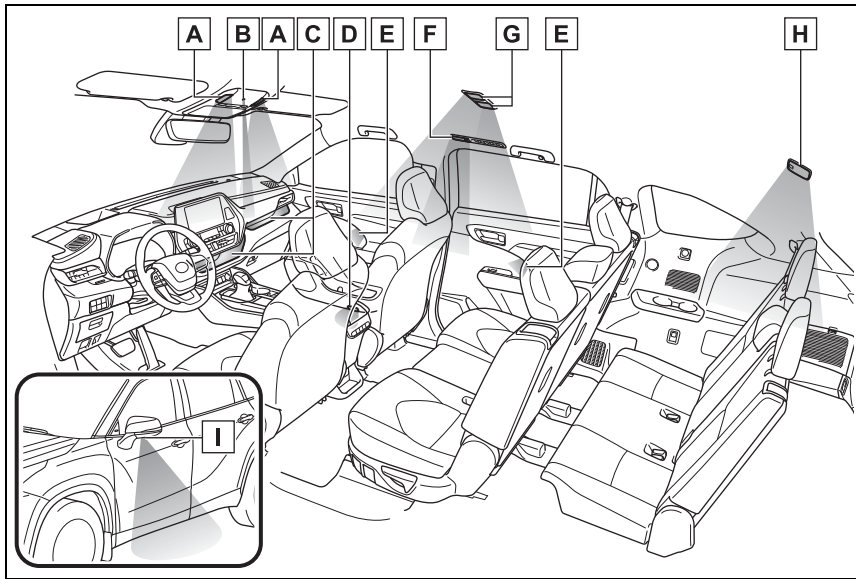

- A** Front personal lights (→P.356)  
Front interior lights (→P.356)
- B** Shift lever light
- C** Open tray lights (if equipped)
- D** Door courtesy lights
- E** Ambient lights (if equipped)
- F** Rear personal lights (if equipped) (→P.356)
- G** Rear personal lights (if equipped) (→P.356)
- H** Rear interior light (→P.356)
- I** Outer foot lights (if equipped)

### Operating the interior lights

#### ■ Front interior lights

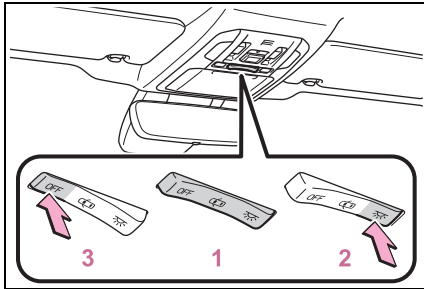

- 1 Turns the lights on/off linked to door positions
- 2 Turns the lights on
- 3 Turns the lights off

#### ■ Rear interior lights

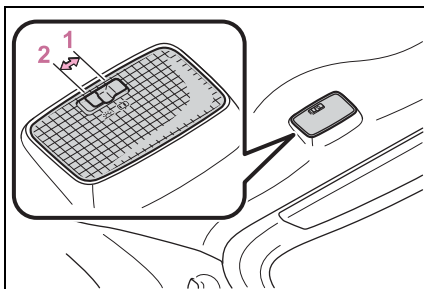

- 1 Turns the door position on  
The rear interior light turns on/off together the front interior lights. When a door is opened while the front and rear interior light door position is on, the lights turn on.
- 2 Turns the light on

### Operating the personal lights

#### ■ Front personal lights

Turns the lights on/off

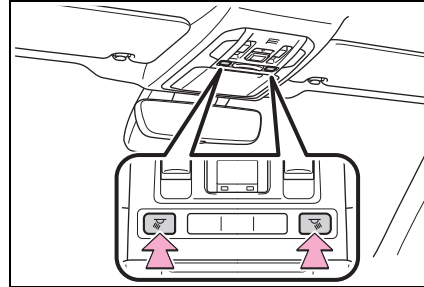

#### ■ Rear personal lights

Turns the lights on/off

- ▶ Vehicles without panoramic moon roof

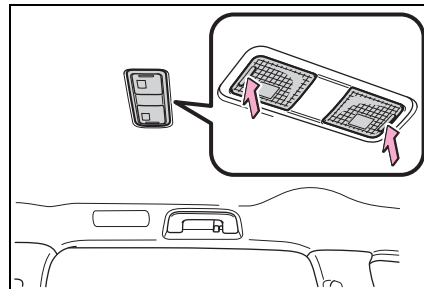

- ▶ Vehicles with panoramic moon roof

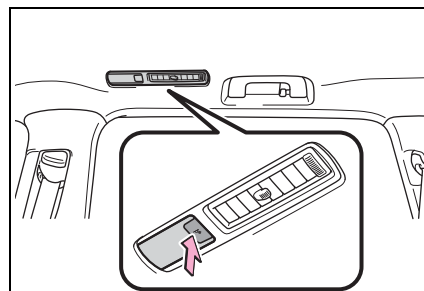

#### ■ Illuminated entry system

The lights automatically turn on/off according to the engine switch mode, the presence of the electronic key, whether the doors are locked/unlocked, and whether the doors are opened/closed.

■ **To prevent the battery from being discharged**

If the interior lights remain on when the engine switch is turned off, the lights will go off automatically after 20 minutes.

■ **The interior lights may turn on automatically when**

If any of the SRS airbags deploy (inflate) or in the event of a strong rear impact, the interior lights will turn on automatically.

The interior lights will turn off automatically after approximately 20 minutes.

The interior lights can be turned off manually. However, in order to help prevent further collisions, it is recommended that they be left on until safety can be ensured.

(The interior lights may not turn on automatically depending on the force of the impact and conditions of the collision.)

■ **Customization**

Some functions can be customized. (→P.515)

	<b>NOTICE</b>
<p>■ <b>To prevent battery discharge</b> Do not leave the lights on longer than necessary when the engine is not running.</p>	

### List of storage features

### Location of the storage features

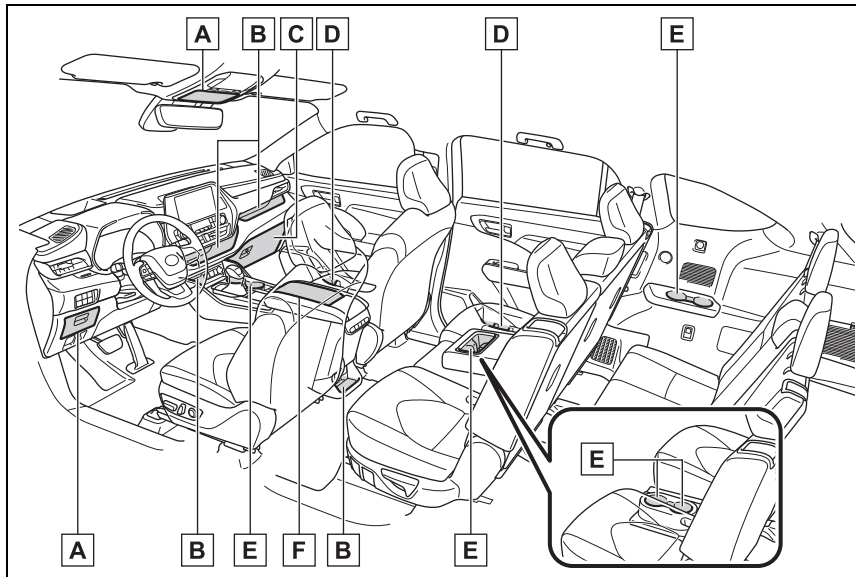

- A** Auxiliary boxes (→P.361)
- B** Open tray (if equipped) (→P.361)
- C** Glove box (→P.359)
- D** Bottle holders (→P.360)
- E** Cup holders (→P.360)
- F** Console box (→P.359)

**⚠ WARNING**

**■ Items that should not be left in the storage spaces**

Do not leave glasses, lighters or spray cans in the storage spaces, as this may cause the following when cabin temperature becomes high:

- Glasses may be deformed by heat or cracked if they come into contact with other stored items.

- Lighters or spray cans may explode. If they come into contact with other stored items, the lighter may catch fire or the spray can may release gas, causing a fire hazard.

**⚠ WARNING**

■ **When storage compartments are not in use**

When driving or when the storage compartments are not in use, keep the lids closed.

In the event of sudden braking or sudden swerving, an accident may occur due to an occupant being struck by an open lid or the items stored inside.

**Glove box**

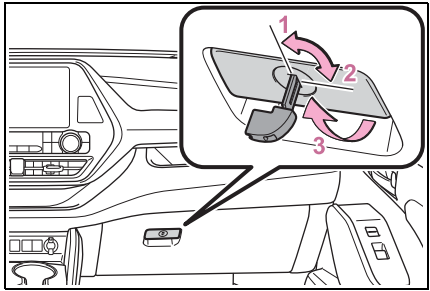

- 1 Unlock with the mechanical key
- 2 Lock with the mechanical key
- 3 Open (pull lever)

■ **Glove box light**

The glove box light turns on when the tail lights are on.

**Console box**

- 1 Push the tab and slide the console box lid.

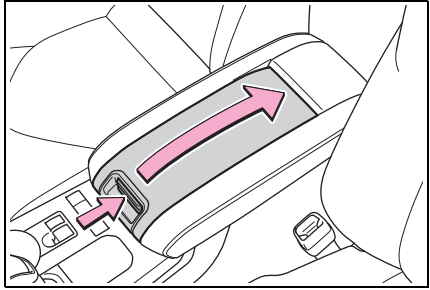

- 2 Vehicles with wireless charge: Lift the wireless charger.

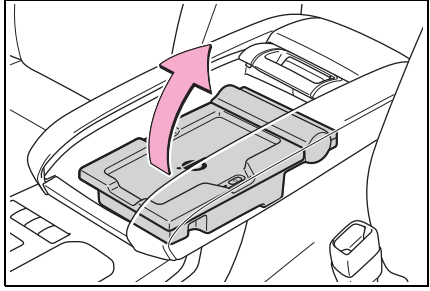

■ **Tray inside console box**

The tray can be slid forward/backward.

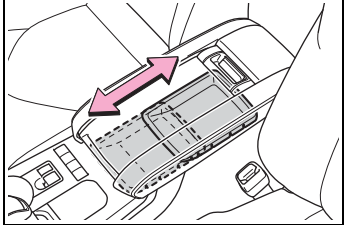

**Cup holders**

▶ Front seats

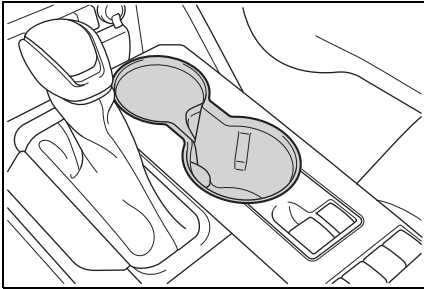

▶ Second seats (8-seat models)

Pull the armrest down.

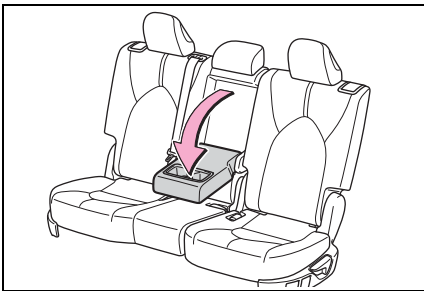

▶ Second seats (7-seat models)

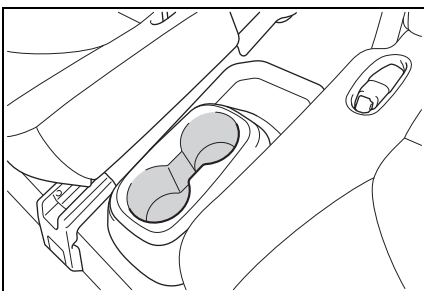

▶ Third seats

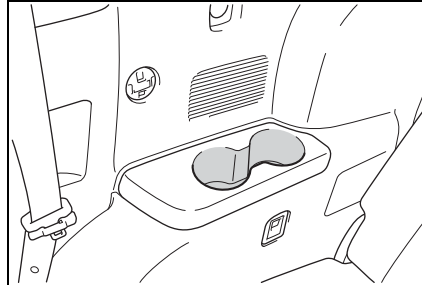

**! WARNING**

**■ Items unsuitable for the cup holder**

Do not place anything other than cups, aluminum cans, or water bottles in the cup holders. Other items may be thrown out of the holders in the event of an accident or sudden braking, possibly causing injury. If possible, cover hot drinks to prevent burns.

**Bottle holders**

▶ Front doors

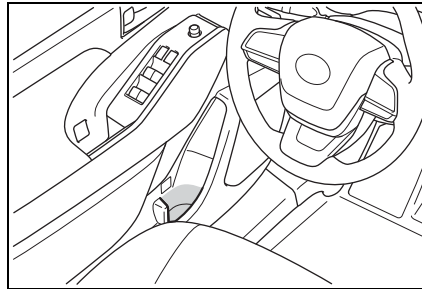



► Rear doors

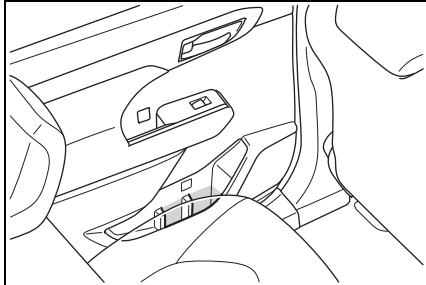

■ **Bottle holders**

- When storing a bottle, close the cap.
- The bottle may not be stored depending on its size or shape.

 **NOTICE**

■ **Items unsuitable for the bottle holders**

Do not place open bottle, glass or paper cups containing liquid in the bottle holders. Otherwise, contained liquid may be spilled. Glass cups may break if used in the bottle holders.

■ **Auxiliary boxes**

► Overhead

Push the lid.

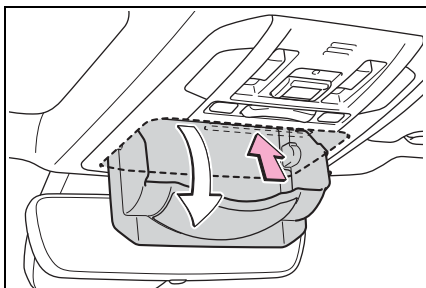

► Driver's side instrument panel

Pull the tab to open.

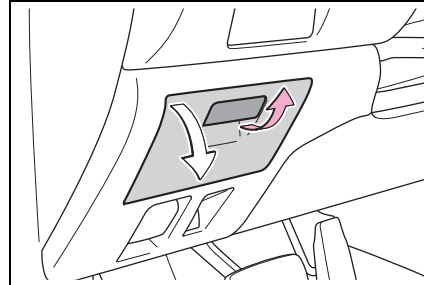

 **WARNING**

■ **Items unsuitable for storing (Overhead)**

Do not store items heavier than 0.44 lb. (200 g). Doing so may cause the auxiliary box to open and the items inside may fall out, resulting in an accident.

■ **Caution while driving (Driver's side instrument panel)**

Keep the auxiliary box closed while driving. Injuries may result in the event of an accident or sudden braking.

■ **Open tray**

► Instrument panel

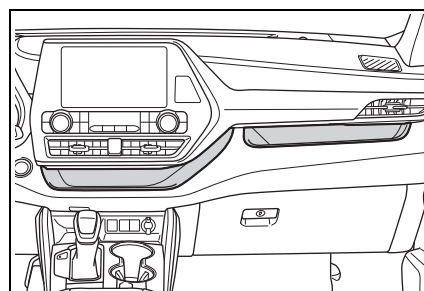

► Front of console

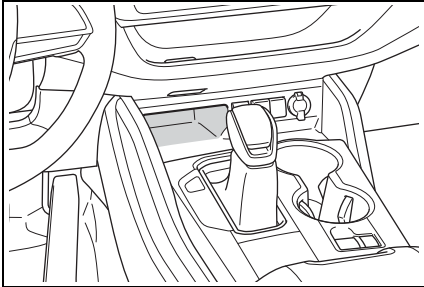

► Rear of console box (if equipped)

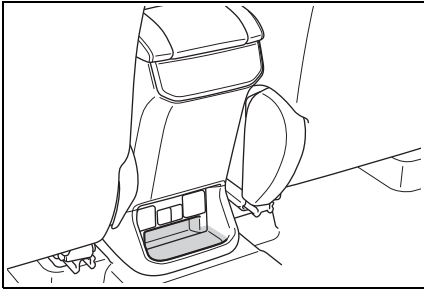

■ Cable pass through (Instrument panel)

The open tray is provided with a hole that allows cables to be passed through the tray from the USB port, USB charging ports or power outlet.

Remove the cover.

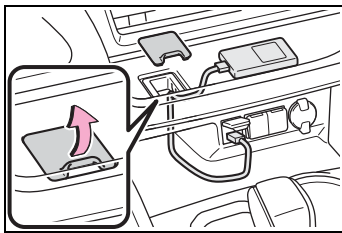

**⚠ WARNING**

■ **Items unsuitable for the open tray**

Observe the following precautions when putting items in the open tray. Failure to do so may cause items to be thrown out of the tray in the event of sudden braking or steering. In these cases, the items may interfere with pedal operation or cause driver distraction, resulting in an accident.

- Do not store items in the tray that can easily shift or roll out.
- Do not stack items in the tray higher than the tray's edge.
- Do not put items in the tray that may protrude over the tray's edge.

**Luggage compartment features**

**Cargo hooks**

Pull down the hook to use.

The cargo hooks are provided for securing loose items.

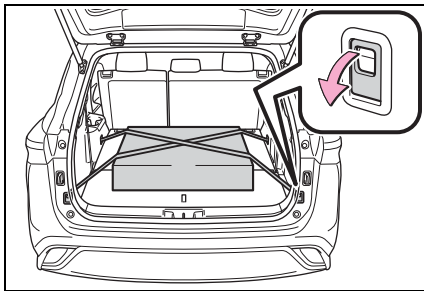

**⚠ WARNING**

■ **When cargo hooks are not in use**

To avoid injury, always return the hooks to their stowed positions when not in use.

**Cargo net hooks**

To hang the cargo net, use the cargo net hooks and cargo hooks.

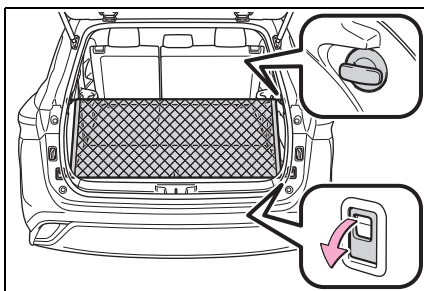

**⚠ WARNING**

■ **When the cargo net is not in use**

To avoid injury, always return the hooks to their stowed positions when not in use.

**Grocery bag hooks**

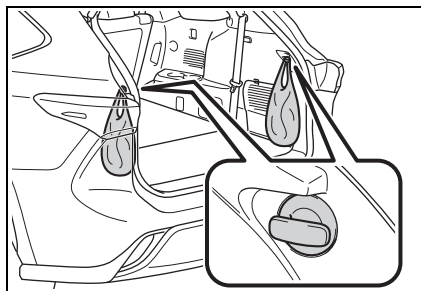

**⚠ NOTICE**

■ **To prevent damage to the grocery bag hooks**

Do not hang any object heavier than 6.6 lb. (3 kg) on the grocery bag hooks.

**Luggage cover (if equipped)**

■ **Removing the luggage cover unit (vehicles without side deck board)**

- 1 Fold down the third seats. (→P.143)

**364** 5-4. Using the storage features

- 2 Remove the center deck board (→P.467) and take out the luggage cover unit.

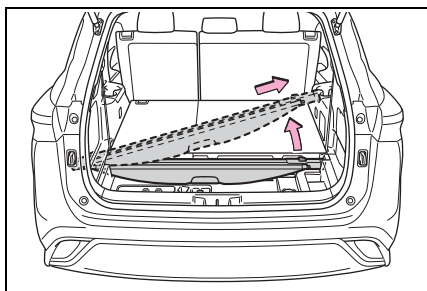

■ **Removing the luggage cover unit (vehicles with side deck board)**

- 1 Fold down the third seats. (→P.143)
- 2 Remove the center deck board (→P.467) and side deck board (→P.366) and take out the luggage cover unit.

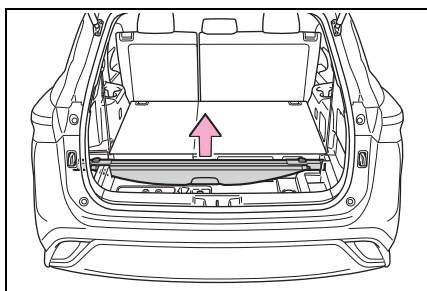

■ **Installing the luggage cover**

- 1 Fold down the third seats. (→P.143)

- 2 Press the lock release buttons to extend the ends of the luggage cover unit.

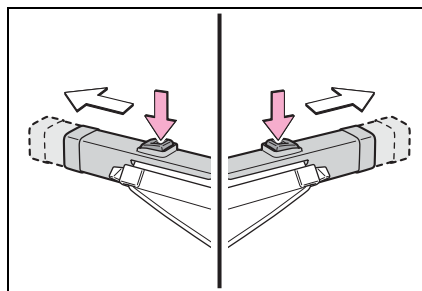

- 3 To install the luggage cover unit, with the lock release buttons facing upward, insert one end into the recess, then compress the other end and insert it into the other recess.

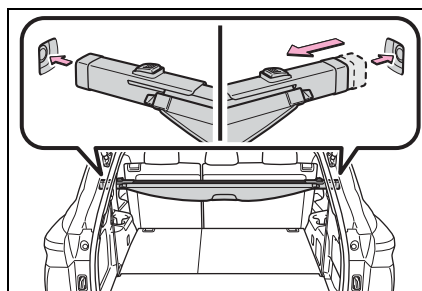

- 4 Pull out the luggage cover and hook it onto the anchors.

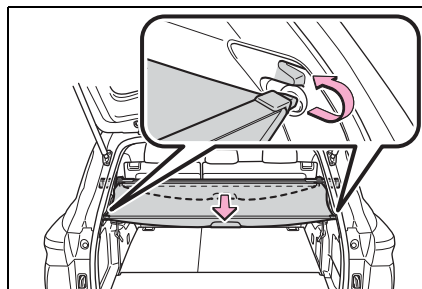

■ **Removing the luggage cover**

- 1 Release the cover from the left and right anchors and allow it to retract.

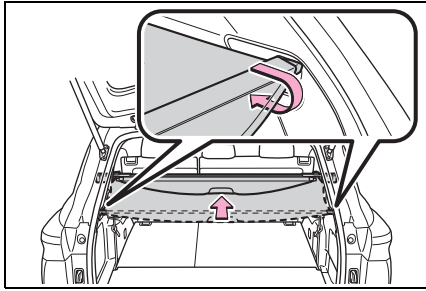

- 2 Compress the end of the luggage cover and lift the luggage cover up.

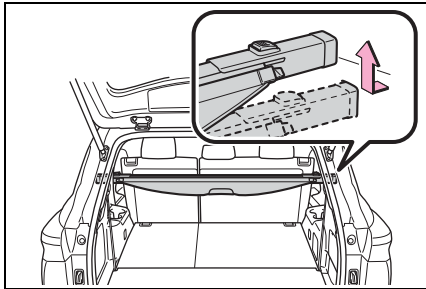

■ **Stowing the luggage cover (vehicles without side deck board)**

- 1 Remove the center deck board. (→P.467)
- 2 To store the luggage cover unit, compress both ends until they lock.

Store the unit with the lock release buttons facing up and the cover portion facing the rear of the vehicle.

cle.

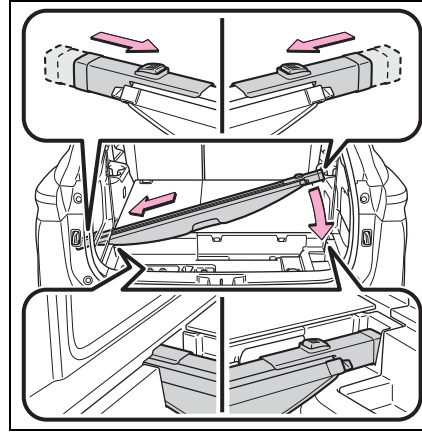

■ **Stowing the luggage cover (vehicles with side deck board)**

- 1 Remove the center deck board (→P.467) and the side deck board. (→P.366)
- 2 To store the luggage cover unit, compress both ends until they lock.

Store the unit with the lock release buttons facing up and the cover portion facing the rear of the vehicle.

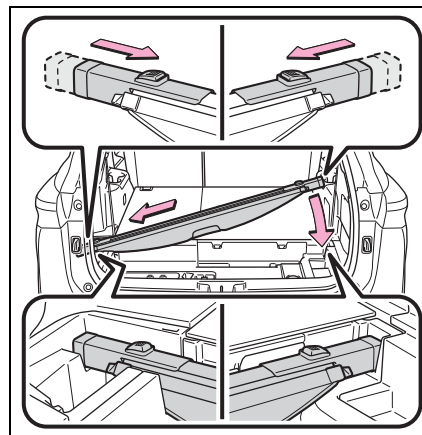

**⚠ WARNING**

■ **Luggage cover**

- When installing/stowing the luggage cover, make sure that the luggage cover is securely installed/stowed. Failure to do so may result in serious injury in the event of sudden braking or a collision.
- Do not place anything on the luggage cover. In the event of sudden braking or turning, the item may go flying and strike an occupant. This could lead to an unexpected accident, resulting in death or serious injury.
- Do not allow children to climb on the luggage cover. Climbing on the luggage cover could result in damage to the luggage cover, possibly causing death or serious injury to the child.
- Do not point the luggage cover unit at your face or body, as doing so may cause injuries if the cover ends extend suddenly.

**⚠ NOTICE**

■ **When using the luggage cover**

- Do not put heavy items on the luggage cover.
- Install the cover unit in the correct direction so that the lock release button faces upward.

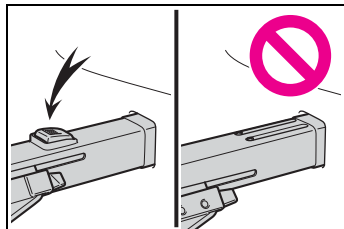

**Auxiliary boxes**

▶ **Center deck under tray**

Pull the strap upwards to open the center deck board.

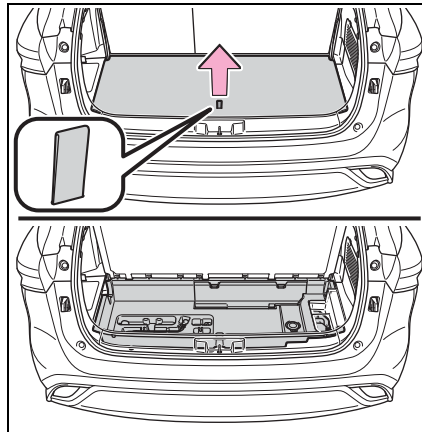

▶ **Deck side box (if equipped)**

Pull the strap upwards to open the side deck board.

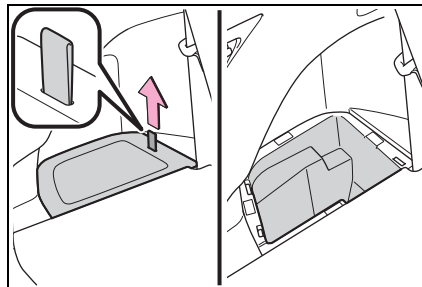

**⚠ WARNING**

■ **Caution while driving**

Keep the deck board closed. In the event of sudden braking, an accident may occur due to an occupant being struck by the deck board or the items stored under the deck board.

**Other interior features**

**USB charging ports**

The USB charging ports are used to supply 2.1 A of electricity at 5 V to external devices. The USB charging ports are for charging only. They are not designed for data transfer or other purposes.

Depending on the external device, it may not charge properly. Refer to the manual included with the device before using a USB charging port.

■ **Using the USB charging ports**

- ▶ On the instrument panel

Open the lid.

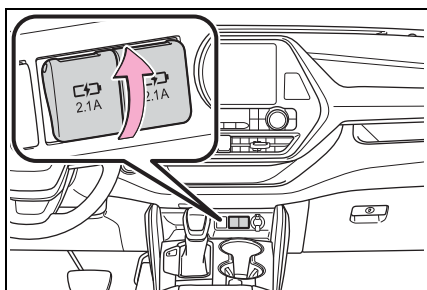

- ▶ Rear of console box

Open the lid.

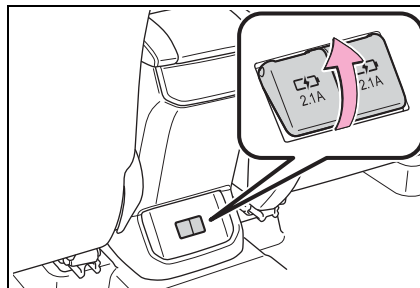

■ **The USB charging ports can be used when**

The engine switch is in ACC or ON.

■ **Situations in which the USB charging ports may not operate correctly**

- If a device which consumes more than 2.1 A at 5 V is connected
- If a device designed to communicate with a personal computer, such as a USB memory device, is connected
- If the connected external device is turned off (depending on device)
- If the temperature inside the vehicle is high, such as after the vehicle has been parked in the sun

■ **About connected external devices**

Depending on the connected external device, charging may occasionally be suspended and then start again. This is not a malfunction.

 **NOTICE**

■ **To prevent damage to the USB charging ports**

- Do not insert foreign objects into the ports.
- Do not spill water or other liquids into the ports.
- When the USB charging ports are not in use, close the lids. If a foreign object or liquid enters a port may cause a short circuit.

 NOTICE

- Do not apply excessive force to or impact the USB charging ports.
  - Do not disassemble or modify the USB charging ports.
  - **To prevent damage to external devices**
  - Do not leave external devices in the vehicle. The temperature inside the vehicle may become high, resulting in damage to an external device.
  - Do not push down on or apply unnecessary force to an external device or the cable of an external device while it is connected.
  - **To prevent battery discharge**
- Do not use the USB charging ports for a long period of time with the engine stopped.

**Wireless charger (if equipped)**

A portable device, such as a smartphone or mobile battery, can be charged by just placing it on the charging area, provided the device is compatible with the Qi wireless charging standard created by the Wireless Power Consortium.

The wireless charger cannot be used with a portable device that is larger than the charging area. Additionally, depending on the portable device, the wireless charger may not operate properly. Refer to the operation man-

ual of the portable device.

■ **The “Qi” symbol**

The “Qi” symbol is a trademark of the Wireless Power Consortium.



■ **Name for all parts**

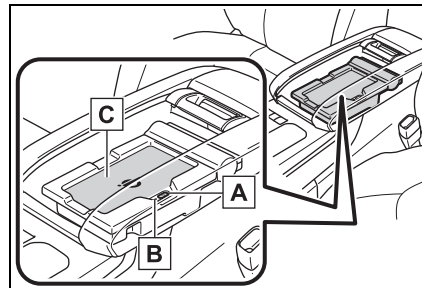

- A** Power supply switch
- B** Operation indicator light
- C** Charge area

■ **Using the wireless charger**

- 1 Push the tab and slide the console box lid. (→P.359)
- 2 Press the power supply switch of the wireless charger.

Pressing the switch again turns the wireless charger off.

When turned on, the operation indicator light (green) comes on.

When the engine switch is turned off, the on/off state of the wireless



charger will be memorized.

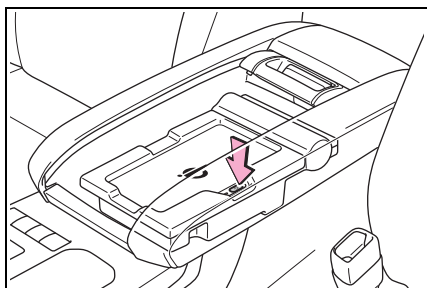

- 3** Place a portable device on the charging area with its charging surface facing down.

While charging, the operation indicator light (orange) will be illuminated.

If charging does not begin, move the portable device as close to the center of the charging area as possible.

When charging is complete, the operation indicator light (green) will illuminate.

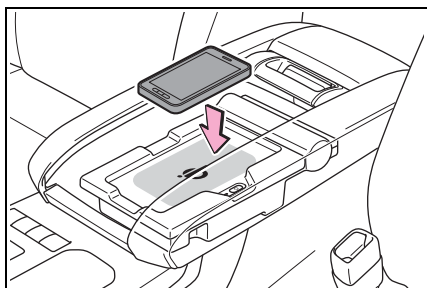

**■ Recharging function**

- If a certain amount of time has elapsed since charging completed and the portable device has not been moved, the wireless charger will restart charging.
- If the portable device is moved within the charging

area, charging will stop temporarily then restart.

**■ Operation indicator light status**

Operation indicator light	State
Off	The Wireless charger is off
Green (illuminated)	Standby (charging is possible)
	Charging is complete*
Orange (illuminated)	A portable device has been placed on the charging area (identifying the portable device)
	Charging in progress

\*: Depending on the portable device, the operation indicator light may stay illuminated (orange) after charging has completed.

**■ If the operation indicator light blinks**

If an error is detected, the operation indicator light will blink (orange). Take the appropriate measures according to the table below.

- Blinks (orange) at a one second interval continuously

## 370 5-5. Using the other interior features

Suspected causes	Measure
Vehicle to charger communication failure.	Contact your Toyota dealer.

- Blinks (orange) 3 times repeatedly

Suspected causes	Measure
A foreign object exists between the portable device and charging area.	Remove the foreign object.
Portable device is not positioned properly on the charging area.	Move the portable device toward the center of the charging area.

- Blinks (orange) 4 times repeatedly

Suspected causes	Measure
The temperature of the wireless charger is excessively high.	Stop charging immediately and continue charging after a while.

### ■ The wireless charger can be operated when

The engine switch is in ACC or ON.

### ■ Portable devices that can be charged

- Portable devices compatible with the Qi wireless charging standard can be charged by the wireless

charger. However, compatibility with all devices which meet the Qi wireless charging standard is not guaranteed.

- The wireless charger is designed to supply low power electricity (5 W or less) to a cellular phone, smartphone, or other portable device.

### ■ If a cover or accessory is attached to the portable device

Do not charge a portable device if a cover or accessory which is not Qi compatible is attached. Depending on the type of cover and/or accessory attached, it may not be possible to charge the portable device. If the portable device is placed on the charging area and does not charge, remove the cover and/or accessories.

### ■ If interference is heard in AM radio broadcasts while charging

Turn off the wireless charger and check if the noise is reduced. If noise is reduced, press and hold the power supply switch of the wireless charger for 2 seconds. The frequency of the wireless charger is changed and noise may be reduced. When the frequency is changed, the operation indicator light will blink (orange) 2 times.

### ■ Charging precautions

- If the electronic key cannot be detected in the cabin, charging cannot be performed. When a door is opened and closed, charging may be temporarily suspended.
- While charging, the wireless charger and the portable device will become warm. This is not a malfunction. If a portable device becomes warm while charging and charging stops due to the protection function of the portable device, wait until the portable device cools down and charge it

again.

■ **Sound generated during operation**

When the power supply switch is turned on or while a portable device

is being identified, operation sounds may be heard. This is not a malfunction.

■ **Cleaning the wireless charger**  
→P.391

■ **Certification for the wireless charger**

FCC Provided Information:  
This equipment has been tested and found to comply with Part 18 of the FCC Rules. These limits are designed to provide reasonable protection against harmful interference in a residential installation. Any changes or modifications not expressly approved by the party responsible for compliance could void the user's authority to operate this equipment.  
This device complies with Part 18 of the FCC Rules. Operation is subject to the following two conditions:  
(1) This device may not cause harmful interference, and (2) this device must accept any interference received, including interference that may cause undesired operation.

Declaration of Conformity  
Trade Name: Panasonic  
Model Numbers: AT1701 contains CA-QS03J1AJ  
Responsible Party: Panasonic Corporation of North America  
Two Riverfront Plaza, Newark, NJ 07102-5490  
Support Contact: <http://shop.panasonic.com/support/>



PRODUCT SAFETY AND COMPLIANCE DEPARTMENT . PANASONIC CORPORATION OF NORTH AMERICA . TWO RIVERFRONT PLAZA, 8<sup>TH</sup> FLOOR, NEWARK, NJ 07102-5480

## FCC Declaration of Conformity Summary

Product Name	In-Vehicle Wireless Charger	
Model Number	AT1701	
Brand Name	Panasonic	
Size and Mass	• 245mm (w), 136mm (l) and 48mm (h) and mass is 515grams	
Purpose Updated DoC	Added similarity variant model / AT1701 contains CA-QS03J1AJ	
Compliance Information	<ul style="list-style-type: none"> <li>• 47 CFR, FCC Part 18, Subpart C for ISM Equipment FCC' s KDB 680106 D01 RF Exposure Wireless Charging Apps v02</li> <li>• Industry Canada RSS-216, Issue 1, dated August 2014 For Wireless Power Transfer Devices (Wireless Chargers)</li> </ul>	
Responsible Applicant	Panasonic Corporation Automotive & Industrial Systems Company Automotive Infotainment Systems Business Division 4261, Ikonobe-cho, Tsuzuki-ku, Yokohama-shi, 224-8520, Japan	
Responsible Factories	<ul style="list-style-type: none"> <li>• Panasonic Corporation, Automotive &amp; Industrial Systems Company Automotive Infotainment / Systems Business Division Global Manufacturing Innovation Center, Matsumoto Factory 5652 Sasaga, Matsumoto city, Nagano 399-8730, Japan</li> <li>• Panasonic Automotive Systems Czech, s.r.o. U Panasonicu 266, 530 06 Pardubice-Stare Covice, Czech Republic</li> <li>• Panasonic Automotive Systems Asia Pacific (Thailand) Co.,Ltd. 101 Moo 2 Teparak Road, T.Bangsaothong Ging A.Bangsaothong Samutprakam 10540 Thailand</li> <li>• Panasonic Automotive Systems Dalian Co., Ltd. No.300, HongGang Road, GanJingZi District, Dalian, Liaoning Province, 116033 China</li> </ul>	
Responsible Sales Company	Panasonic Consumer Electronics Company Division of Panasonic Corporation of North America Two Riverfront Plaza, Newark, NJ 07102-5490 General Contact: <a href="http://shop.panasonic.com/support">http://shop.panasonic.com/support</a>	
Special Conditions For Compliance	In-Vehicle Wireless Charger will be installed and used exclusively within transportation vehicle and as such, it is exempt from the following requirements: (1) Part 15 digital device technical rules in accordance with §15.103(a); and (2) §15.105(b) full text information to user to appear in User Manual in accordance with §18.213.	
EMI Test Report	TCB	UL Japan
	Test Report	10120384-R2
	Model Tested	AT1701 contains CA-QS03J1AJ
	Date Issued	12/14/2015
	Methodology	FCC-OET MP-4



PRODUCT SAFETY AND COMPLIANCE DEPARTMENT . PANASONIC CORPORATION OF NORTH AMERICA . TWO RIVERFRONT PLAZA, 8<sup>TH</sup> FLOOR, NEWARK, NJ 07102-5480



PRODUCT SAFETY AND COMPLIANCE DEPARTMENT . PANASONIC CORPORATION OF NORTH AMERICA . TWO RIVERFRONT PLAZA, 8<sup>TH</sup> FLOOR, NEWARK, NJ 07102-6480

**FCC Declaration of Conformity**

**Summary**

RF Exposure Evaluation	TCB	UL Japan
	MPE Test Report	10197157S-E-R1
	Model Tested	AT1701 contains CA-QS03J1AJ
	Date Issued	12/14/2015
	Methodology	KDB 680106 D01 RF Exposure Wireless Charging Apps v02
Importation	The subject In-Vehicle Wireless Charger can be imported on behalf of Panasonic affiliated sales companies by PNA's Logistics Import Customs, or their authored brokers, by electrically filing FCC Form 740 while declaring Box 2 with no reference to any FCC ID.	

This DoC is granted for the subject In-Vehicle Wireless Charger on the basis of the manufacturer's attested compliance with the above described conditions and in accordance with FCC Part 18 and FCC's KDB 0680106 D01 RF Exposure Wireless Charging Apps v02.

Certificate Number: DoC 2014-008C  
 Applicant Ref No.: PAS-16-F001

*Richard Mullen*  
 Issued by: Richard Mullen  
 Issue Date: January 14, 2016

PRODUCT SAFETY AND COMPLIANCE DEPARTMENT . PANASONIC CORPORATION OF NORTH AMERICA . TWO RIVERFRONT PLAZA, 8<sup>TH</sup> FLOOR, NEWARK, NJ 07102-6480

**⚠ WARNING**

■ **Caution while driving**

When charging a portable device while driving, for safety reasons, the driver should not operate the portable device.

 **WARNING**

■ **Caution regarding interference with electronic devices**

People with implantable cardiac pacemakers, cardiac resynchronization therapy pacemakers or implantable cardioverter defibrillators, as well as any other electrical medical device, should consult their physician about the usage of the wireless charger.

Operations of the wireless charger may have an affect on medical devices.

■ **To prevent damage or burns**

Observe the following precautions.

Failure to do so may result in the possibility of fire, equipment failure or damage, or burns due to heat.

- Do not put any metallic objects between the charging area and the portable device while charging.
- Do not attach metallic objects, such as aluminum stickers, to the charging area.
- Do not cover the wireless charger with a cloth or other object while charging.
- Do not attempt to charge portable devices which are not compatible with the Qi wireless charging standard.
- Do not disassemble, modify or remove the wireless charger.
- Do not apply force or impact to the wireless charger.

 **NOTICE**

■ **Conditions in which the wireless charger may not operate correctly**

In the following situations, the wireless charger may not operate correctly:

- When a portable device is fully charged
- When there is a foreign object between the charging area and portable device
- When a portable device becomes hot while charging
- When a portable device is placed on the wireless area with its charging surface facing up
- When a portable device is not centered on the charging area
- When the vehicle is near a TV tower, electric power plant, gas station, radio station, large display, airport or other facility that generates strong radio waves or electrical noise
- When the portable device is in contact with, or is covered by any of the following metallic objects:
  - Cards to which aluminum foil is attached
  - Cigarette boxes that have aluminum foil inside
  - Metallic wallets or bags
  - Coins
  - Metal hand warmers
  - Media such as CDs and DVDs
- When wireless keys (that emit radio waves) other than those of your vehicle are being used nearby.

 **NOTICE**

If in situations other than above the wireless charger does not operate properly or the operation indicator light is blinking, the wireless charger may be malfunctioning. Contact your Toyota dealer.

■ **To prevent failure or damage to data**

● Do not bring magnetic cards, such as a credit card, or magnetic recording media, close to the wireless charger while charging. Otherwise, data may be erased due to the influence of magnetism. Additionally, do not bring precision instruments such as wrist watches, close to the wireless charger, as such objects may malfunction.

● Do not leave portable devices in the cabin. The temperature inside the cabin may become high when parked in the sun, and cause damage to the device.

■ **To prevent battery discharge**

Do not use the wireless charger for a long period of time with the engine is stopped.

**Armrest**

► **Second seats (8-seat models)**

Pull the armrest down for use.

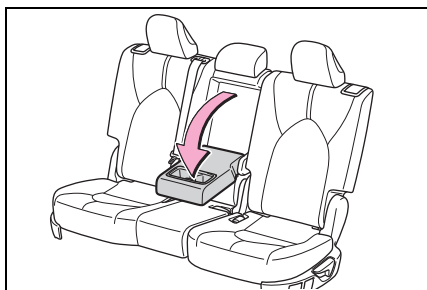

► **Second seats (7-seat models)**

Pull the armrest down for use.

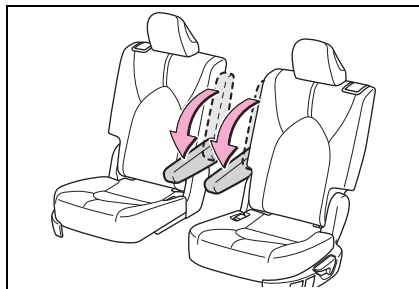

 **NOTICE**

■ **To prevent damage to the armrest**

Do not apply too much load on the armrest.

**Assist grips**

An assist grip installed on the ceiling can be used to support your body while sitting on the seat.

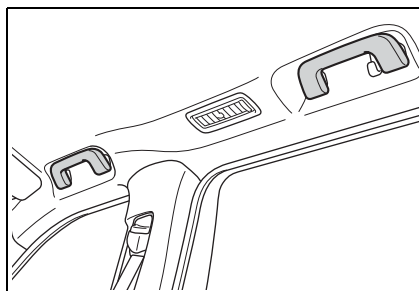

 **WARNING**

■ **Assist grip**

Do not use the assist grip when getting in or out of the vehicle or rising from your seat.

 NOTICE

■ **To prevent damage to the assist grip**

Do not hang any heavy object or put a heavy load on the assist grip.

**Coat hooks**

The coat hooks are provided with the rear assist grips.

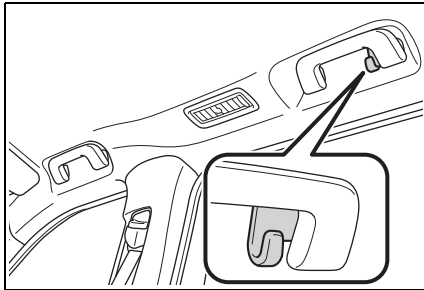

 WARNING

■ **Items that must not be hung on the hook**

Do not hang coat hangers or other hard or sharp objects on the hook. If the SRS curtain shield airbags deploy, these items may become projectiles, causing death or serious injury.

**Power outlets**

■ **12 V**

Please use as a power supply for electronic goods that use less than 12 VDC/10 A (power consumption of 120 W).

When using electronic goods, make sure that the power consumption of all the connected power outlets is less than 120

W.

- ▶ On the instrument panel

Open the lid.

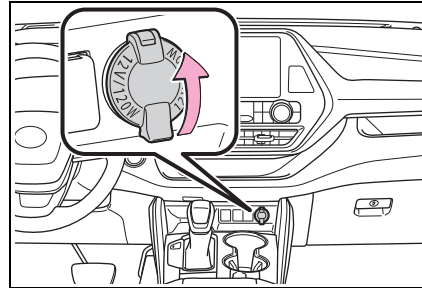

- ▶ Inside the console box

Open the lid.

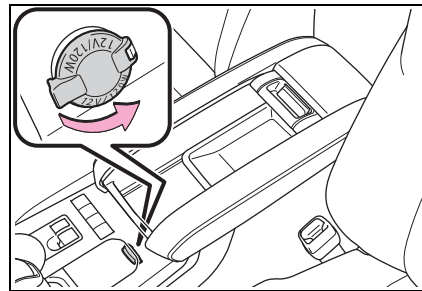

■ **120 VAC (if equipped)**

Accessories that use less than 100 W.

Open the lid.

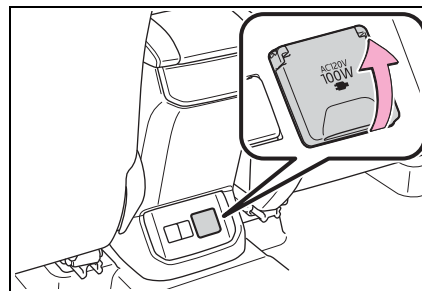



■ **The power outlet can be used when**

- ▶ 12 V

The engine switch is in ACC or ON.

- ▶ 120 VAC (if equipped)

The engine switch is in ON.

■ **Using the power outlet (vehicles with Stop & Start system)**

When the engine restarts after having been stopped by the Stop & Start system, the power outlets may be temporarily unusable, but this is not a malfunction.

■ **When turning the engine switch off**

Disconnect electrical devices with charging functions, such as mobile battery packs. If such devices are left connected, the engine switch may not be turned off normally.

- Measuring devices that process precise data
- Other appliances that require an extremely stable power supply

**Sun visors**

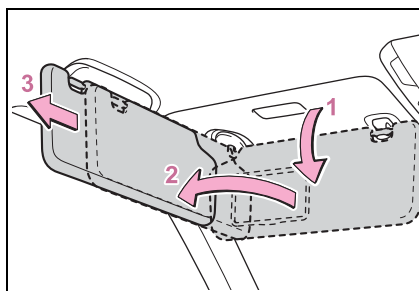

- 1 To set the visor in the forward position, flip it down.
- 2 To set the visor in the side position, flip down, unhook, and swing it to the side.
- 3 To use the side extender, place the visor in the side position, then slide it backward.

 **NOTICE**

■ **To avoid damaging the power outlet**

Close the power outlet lid when the power outlet is not in use. Foreign objects or liquids that enter the power outlet may cause a short circuit.

■ **To prevent the battery from being discharged**

Do not use the power outlet longer than necessary when the engine is not running.

■ **Appliances that may not operate properly (120 VAC)**

The following 120 VAC appliances may not operate properly even if their power consumption is under 100 W.

- Appliances with high initial peak wattage

**Vanity mirrors**

Open the cover.

The light turns on when the cover is opened.

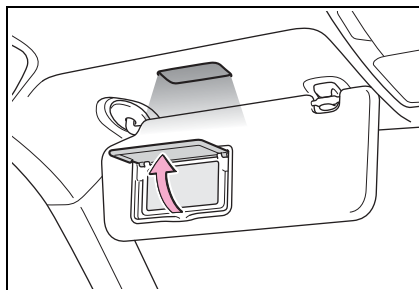

■ **To prevent battery discharge**

If the vanity lights remain on when the engine switch is turned off, the lights will go off automatically after 20 minutes.

 NOTICE

■ **To prevent the battery from being discharged**

Do not leave the vanity lights on for extended periods while the engine is off.

**Conversation mirror**

- 1 Push the lid.

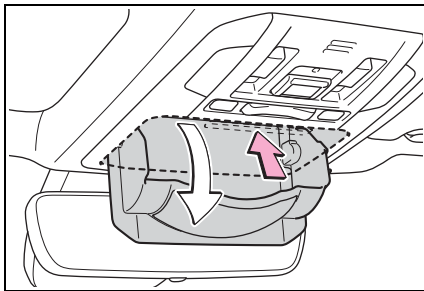

- 2 Push the lid back up half way.

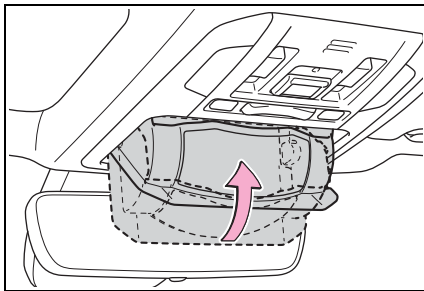

■ **To use the overhead console from the conversation mirror state**

Fully close the lid, then open it again. (→P.361)

**Rear door sunshades (if equipped)**

- 1 Pull the tab up.

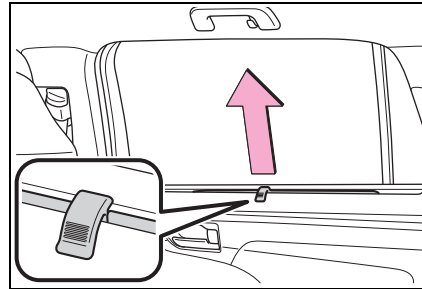

- 2 Hook the sunshade on to the anchors.

To lower the sunshade, pull the tab up slightly to unhook the shade from the anchors, and lower it slowly.

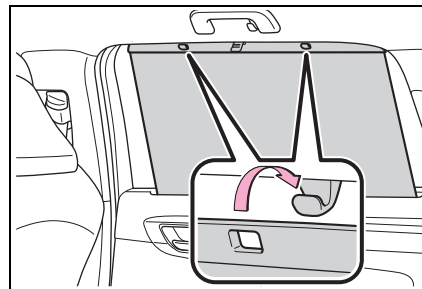

 NOTICE

■ **To ensure normal operation of the sunshades**

- Do not put anything in an area where it may interfere with the operation of a rear door sunshade.
- To prevent damage to the rear door sunshades, do not apply excessive load or attach items to the rear door sunshades.

**Garage door opener\***

\*: If equipped

The garage door opener can be programmed using the HomeLink® to operate garage doors, gates, entry doors, door locks, home lighting systems, security systems, and other devices.

**System components**

The HomeLink® wireless control system in your vehicle has 3 buttons which can be programmed to operate 3 different devices. Refer to the programming methods on the following pages to determine the method which is appropriate for the device.

- ▶ Vehicles with auto anti-glare inside rear view mirror

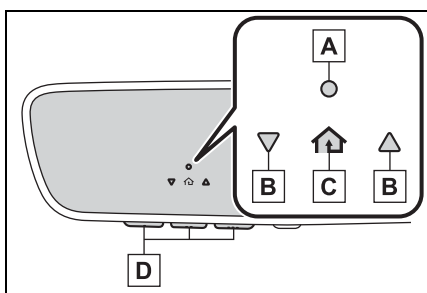

- A** HomeLink® indicator light
- B** Garage door operation indicators
- C** HomeLink® icon  
Illuminates while HomeLink® is

operating.

- D** Buttons
- ▶ Vehicles with Digital Rearview Mirror

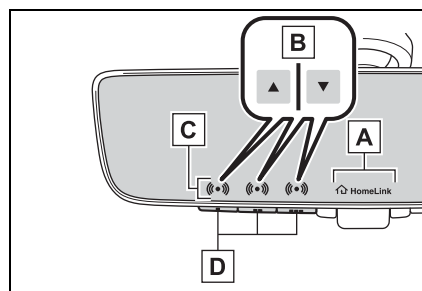

- A** HomeLink® logo  
Appears while HomeLink® is operating. When the menu button (→P.152) is pressed, the logo disappears even while the HomeLink® is operating.
- B** Garage door operation indicators
- C** HomeLink® indicator light  
Illuminates above each button selected.
- D** Buttons

**Codes stored in the HomeLink® memory**

- The registered codes are not erased even if the battery cable is disconnected.
- If learning failed when registering a different code to a HomeLink® button that already has a code registered to it, the already registered code will not be erased.

■ **Certification for the garage door opener**

This device complies with FCC rules part 15 and Innovation, Science, and Economic Development Canada RSS-210. Operation is subject to the following two conditions: (1) This device may not cause harmful interference, and (2) This device must accept any interference that may be received including interference that may cause undesired operation. WARNING: The transmitter has been tested and complies with FCC and ISSED rules. Changes or modifications not expressly approved by the party responsible for compliance could void the user's authority to operate the device.

This equipment complies with FCC and ISSED radiation exposure limits set forth for an uncontrolled environment. End Users must follow the specific operating instructions for satisfying RF exposure compliance. This transmitter must be at least 20 cm from the user and must not be co-located or operating in conjunction with any other antenna or transmitter.

This device complies with FCC rules part 15 and Innovation, Science, and Economic Development Canada RSS-210. Operation is subject to the following two conditions: (1) This device may not cause harmful interference, and (2) This device must accept any interference that may be received including interference that may cause undesired operation. WARNING: The transmitter has been tested and complies with FCC and ISSED rules. Changes or modifications not expressly approved by the party responsible for compliance could void the user's authority to operate the device.

This equipment complies with FCC and ISSED radiation exposure limits set forth for an uncontrolled environment. End Users must follow the specific operating instructions for satisfying RF exposure compliance. This transmitter must be at least 20 cm from the user and must not be co-located or operating in conjunction with any other antenna or transmitter.

Cet appareil est conforme aux règlements de la FCC, section 15, et au CNR-210 d'Innovation, Sciences et Développement économique Canada. Le fonctionnement est assujéti aux deux conditions suivantes : (1) cet appareil ne doit pas causer d'interférences nuisibles et (2) cet appareil doit accepter toute interférence reçue, y compris celle qui pourrait entraîner un dysfonctionnement. MISE EN GARDE : L'émetteur a subi des tests et est conforme aux règlements de la FCC et d'ISDE. Les changements ou modifications non approuvés explicitement par la partie responsable de la conformité pourraient rendre caduque l'autorisation de l'utilisateur de se servir du dispositif.

Cet appareil est conforme aux limites d'exposition aux radiations de la FCC et d'ISDE établies pour un environnement non contrôlé. Les utilisateurs finaux doivent respecter les instructions d'utilisation spécifiques pour satisfaire aux exigences de conformité aux expositions de RF. L'émetteur doit se trouver à 20 cm au minimum de l'utilisateur et ne doit pas être situé au même endroit que tout autre émetteur ou antenne ni fonctionner avec un autre émetteur ou antenne.

■ **When support is necessary**

Visit on the web at [www.homelink.com/toyota](http://www.homelink.com/toyota) or call 1-800-355-3515.

 **WARNING**

■ **When programming a garage door or other remote control device**

The garage door or other device may operate, so ensure people and objects are out of danger to prevent potential harm.

■ **Conforming to federal safety standards**

Do not use the HomeLink® compatible transceiver with any garage door opener or device that lacks safety stop and reverse features as required by federal safety standards.

This includes any garage door that cannot detect an interfering object. A door or device without these features increases the risk of death or serious injury.

■ **When operating or programming HomeLink®**

Never allow a child to operate or play with the HomeLink® buttons.

**Programming the HomeLink®**

■ **Before programming HomeLink®**

- During programming, it is possible that garage doors, gates, or other devices may operate. For this reason, make sure that people and objects are clear of the garage door or other devices to prevent injury or other potential harm.
- It is recommended that a new battery be placed in the remote control transmitter for more accurate programming.
- Garage door opener motors manufactured after 1995 may be equipped with rolling code protection. If this is the case, you may need a stepladder or other sturdy, safe device to reach the “Learn” or “Smart” button on the garage door opener motor.

■ **Programming HomeLink®**

Steps **1** through **3** must be performed within 60 seconds, otherwise the HomeLink® indicator light will stop flashing and programming will not be successfully completed.

- 1** Press and release the HomeLink® button you want to program and check that the

HomeLink® indicator light flashes (orange).

- 2** Point the remote control transmitter for the device at the rear view mirror, 1 to 3 in. (25 to 75 mm) from the HomeLink® buttons.

Keep the HomeLink® indicator light in view while programming.

- ▶ Vehicles with auto anti-glare inside rear view mirror

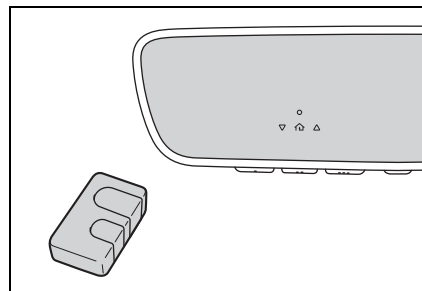

- ▶ Vehicles with Digital Rearview Mirror

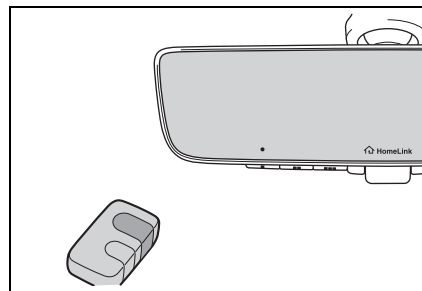

- 3** Program a device.

- ▶ Vehicles with auto anti-glare inside rear view mirror

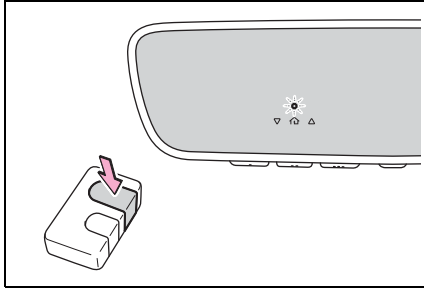

- ▶ Vehicles with Digital Rearview Mirror

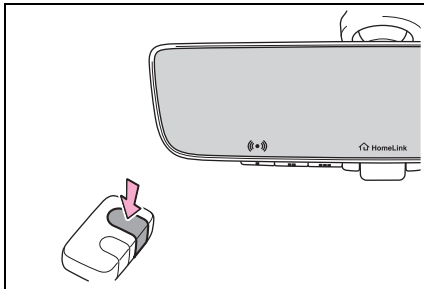

- ▶ Programming a device other than an entry gate (for U.S.A. owners)

Press and hold the remote control transmitter button until the HomeLink<sup>®</sup> indicator light changes from slowly flashing orange to rapidly flashing green (rolling code) or continuously lit green (fixed code), then release the button.

- ▶ Programming an entry gate (for U.S.A. owners)/Programming a device in the Canadian market

Press and release the remote control transmitter button at 2

second intervals, repeatedly, until the HomeLink<sup>®</sup> indicator light changes from slowly flashing (orange) to rapidly flashing (green) (rolling code) or continuously lit (green) (fixed code).

- 4 Test the HomeLink<sup>®</sup> operation by pressing the newly programmed button and observing the indicator light:

- HomeLink<sup>®</sup> indicator light illuminates: Programming of a fixed code device has completed. The garage door or other device should operate when a HomeLink<sup>®</sup> button is pressed and released.

- HomeLink<sup>®</sup> indicator light flashes rapidly: The garage door opener motor or other device is equipped with a rolling code. To complete programming, firmly press and hold the HomeLink<sup>®</sup> button for 2 seconds then release it.

- If the garage door or other device does not operate, proceed to “Programming a rolling code system”.

- 5 Repeat the steps above to program another device for any of the remaining HomeLink<sup>®</sup> buttons.

#### ■ Programming a rolling code system

Two or more people may be necessary to complete rolling

code programming.

- 1 Locate the “Learn” or “Smart” button on the garage door opener motor in the garage.

This button can usually be found where the hanging antenna wire is attached to the unit. The name and color of the button may vary by manufacturer. Refer to the owner’s manual supplied with the garage door opener motor for details.

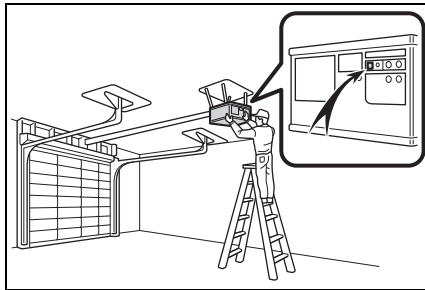

- 2 Press and release the “Learn” or “Smart” button.

Perform **3** within 30 seconds after performing **2**.

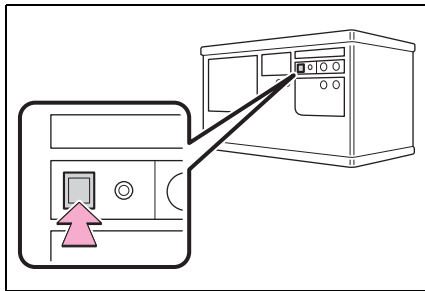

- 3 Press and hold the desired HomeLink® button (inside the vehicle) for 2 seconds and release it. Repeat this sequence (press/hold/release) up to 3 times to complete programming. If the garage door opener

motor operates when the HomeLink® button is pressed, the garage door opener motor recognizes the HomeLink® signal.

- ▶ Vehicles with auto anti-glare inside rear view mirror

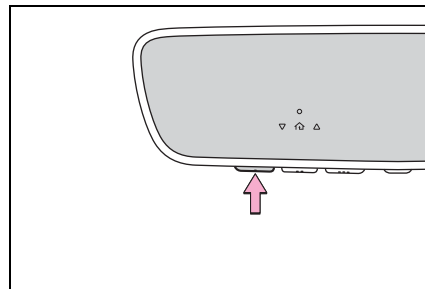

- ▶ Vehicles with Digital Rearview Mirror

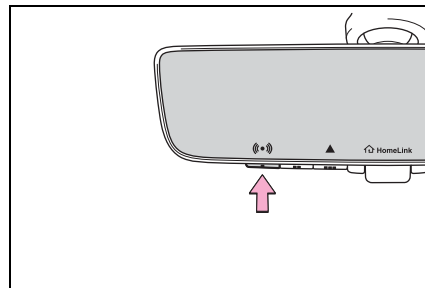

- **Enabling 2-way communication with a garage door (only available for compatible devices)**

When enabled, 2-way communication allows you to check the status of the opening and closing of a garage door through indicators in your vehicle.

2-way communication is only available if the garage door opener motor used is a compati-

ble device. (To check device compatibility, refer to [www.homelink.com](http://www.homelink.com).)

- 1 Within 5 seconds after programming the garage door opener has been completed, if the garage door opener motor is trained to HomeLink<sup>®</sup>, both garage door operation indicators will flash rapidly (green) and the light on the garage door opener motor will blink twice, indicating that 2-way communication is enabled.

If the indicators do not flash, perform **2** and **3** within the first 10 presses of the HomeLink<sup>®</sup> button after programming has been completed.

- 2 Press a programmed HomeLink<sup>®</sup> button to operate a garage door.
- 3 Within 1 minute of pressing the HomeLink<sup>®</sup> button, after the garage door operation has stopped, press the “Learn” or “Smart” button on the garage door opener motor. Within 5 seconds of the establishment of 2-way communication with the garage door opener, both garage door operation indicators in the vehicle will flash rapidly (green) and the light on the garage door opener motor will blink twice, indicat-

ing that 2-way communication is enabled.

#### ■ Reprogramming a single HomeLink<sup>®</sup> button

When the following procedure is performed, buttons which already have devices registered to them can be overwritten:

- 1 Press and hold the desired HomeLink<sup>®</sup> button.
- 2 When the HomeLink<sup>®</sup> indicator starts flashing orange, release the HomeLink<sup>®</sup> button and perform “Programming HomeLink<sup>®</sup>” **1** (it takes 20 seconds for the HomeLink<sup>®</sup> indicator to start flashing).

---

#### ■ Before programming

- Install a new battery in the transmitter.
- The battery side of the transmitter must be pointed away from the HomeLink<sup>®</sup> buttons.

#### Operating HomeLink<sup>®</sup>

Press the appropriate HomeLink<sup>®</sup> button. The HomeLink<sup>®</sup> indicator light should turn on.

The status of the opening and closing of a garage door is shown by the garage door opener indicators.



- ▶ Vehicles with auto anti-glare inside rear view mirror

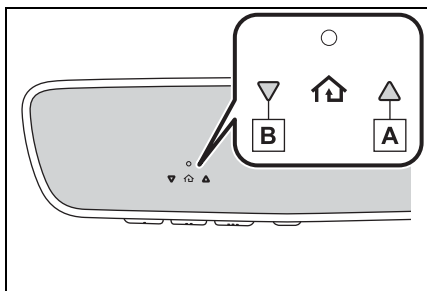

- A** Opening
- B** Closing

- ▶ Vehicles with Digital Rearview Mirror

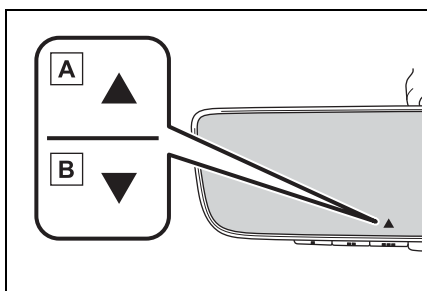









- A** Opening
- B** Closing

This function is only available if the garage door opener motor used is a compatible device. (To check device compatibility, refer to [www.homelink.com](http://www.homelink.com).)

Color	Status
Orange (flashing)	Currently opening/closing

Color	Status
Green	Opening/closing has completed
Red (flashing)	Feedback signals cannot be received

The indicators can operate within approximately 820 ft. (250 m) of the garage door. However, if there are obstructions between the garage door and the vehicle, such as houses and trees, feedback signals from the garage door may not be received.

To recall the previous door operation status, press and release either HomeLink® buttons  and  or  and  (vehicles with auto anti-glare inside rear view mirror),  and  or  and  (vehicles with Digital Rearview Mirror), simultaneously. The last recorded status will be displayed for 3 seconds.

**Erasing the entire HomeLink® memory (all three codes)**

Press and hold the 2 outside buttons for 10 seconds until the HomeLink® indicator light changes from continuously lit (orange) to rapidly flashing (green).

**386** 5-5. Using the other interior features

---

If you sell your vehicle, be sure to erase the programs stored in the HomeLink® memory.

- ▶ Vehicles with auto anti-glare inside rear view mirror

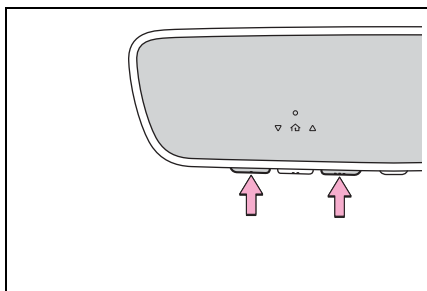

- ▶ Vehicles with Digital Rearview Mirror

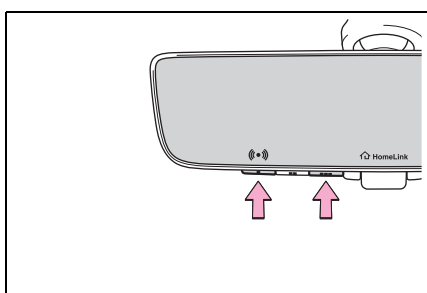

**Maintenance and care****6****6-1. Maintenance and care**

Cleaning and protecting the  
vehicle exterior..... **388**

Cleaning and protecting the  
vehicle interior..... **391**

**6-2. Maintenance**

Maintenance requirements  
..... **394**

General maintenance.. **396**

Emission inspection and  
maintenance (I/M) pro-  
grams ..... **398**

**6-3. Do-it-yourself mainte-  
nance**

Do-it-yourself service pre-  
cautions..... **400**

Hood ..... **402**

Positioning a floor jack  
..... **403**

Engine compartment... **404**

Tires ..... **411**

Tire inflation pressure.. **423**

Wheels ..... **425**

Air conditioning filter.... **426**

Electronic key battery.. **428**

Checking and replacing  
fuses..... **429**

Headlight aim ..... **431**

Light bulbs..... **432**

**Cleaning and protecting the vehicle exterior**

**Perform cleaning in a manner appropriate to each component and its material.**

**Cleaning instructions**

- Working from top to bottom, liberally apply water to the vehicle body, wheel wells and underside of the vehicle to remove any dirt and dust.
- Wash the vehicle body using a sponge or soft cloth, such as a chamois.
- For hard-to-remove marks, use car wash soap and rinse thoroughly with water.
- Wipe away any water.
- Wax the vehicle when the waterproof coating deteriorates.

If water does not bead on a clean surface, apply wax when the vehicle body is cool.

**Automatic car washes**

- Before washing the vehicle:
  - Fold the mirrors
  - Turn off the power back door (if equipped)

Start washing from the front of the vehicle. Extend the mirrors before driving.

- Brushes used in automatic car washes may scratch the vehicle surface, parts (wheel, etc.) and

harm your vehicle's paint.

- Rear spoiler may not be washable in some automatic car washes. There may also be an increased risk of damage to vehicle.

**High pressure car washes**

As water may enter the cabin, do not bring the nozzle tip near the gaps around the doors or perimeter of the windows, or spray these areas continuously.

**When using a car wash**

If the door handle becomes wet while the electronic key is within the effective range, the door may lock and unlock repeatedly. In that case, follow the following correction procedures to wash the vehicle:

- Place the key in a position 6 ft. (2 m) or more separate from the vehicle while the vehicle is being washed. (Take care to ensure that the key is not stolen.)
- Set the electronic key to battery-saving mode to disable the smart key system. (→P.132)

**Wheels and wheel ornaments**

- Remove any dirt immediately by using a neutral detergent.
- Wash detergent off with water immediately after use.
- To protect the paint from damage, make sure to observe the following precautions.
  - Do not use acidic, alkaline or abrasive detergent
  - Do not use hard brushes
  - Do not use detergent on the wheels when they are hot, such as after driving or parking in hot weather

**Bumpers**

Do not scrub with abrasive cleaners.

**Plated portions**

If dirt cannot be removed, clean the parts as follows:

- Use a soft cloth dampened with an

approximately 5% solution of neutral detergent and water to clean the dirt off.

- Wipe the surface with a dry, soft cloth to remove any remaining moisture.
- To remove oily deposits, use alcohol wet wipes or a similar product.

**⚠ WARNING**

■ **When washing the vehicle**

Do not apply water to the inside of the engine compartment. Doing so may cause the electrical components, etc. to catch fire.

■ **When cleaning the windshield (vehicles with rain-sensing windshield wipers)**

Set the wiper switch to off. If the switch is in "AUTO", the wipers may operate unexpectedly in the following situations, and may result in hands being caught or other serious injuries and cause damage to the wiper blades.

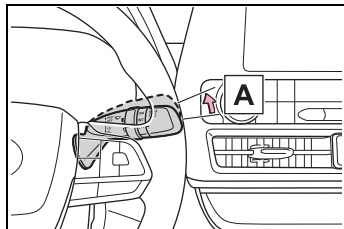

**A** AUTO

- When the upper part of the windshield where the raindrop sensor is located is touched by hand
- When a wet rag or similar is held close to the raindrop sensor
- If something bumps against the windshield

- If you directly touch the raindrop sensor body or if something bumps into the raindrop sensor

■ **Precautions regarding the exhaust pipe**

Exhaust gasses cause the exhaust pipe to become quite hot. When washing the vehicle, be careful not to touch the pipe until it has cooled sufficiently, as touching a hot exhaust pipe can cause burns.

■ **Precaution regarding the rear bumper with Blind Spot Monitor (if equipped)**

If the paint of the rear bumper is chipped or scratched, the system may malfunction. If this occurs, consult your Toyota dealer.

**⚠ NOTICE**

■ **To prevent paint deterioration and corrosion on the body and components (aluminum wheels, etc.)**

- Wash the vehicle immediately in the following cases:
  - After driving near the sea coast
  - After driving on salted roads
  - If coal tar or tree sap is present on the paint surface
  - If dead insects, insect droppings or bird droppings are present on the paint surface
  - After driving in an area contaminated with soot, oily smoke, mine dust, iron powder or chemical substances
  - If the vehicle becomes heavily soiled with dust or mud
  - If liquids such as benzene and gasoline are spilled on the paint surface

 **NOTICE**

- If the paint is chipped or scratched, have it repaired immediately.
- To prevent the wheels from corroding, remove any dirt and store in a place with low humidity when storing the wheels.

■ **Cleaning the exterior lights**

- Wash carefully. Do not use organic substances or scrub with a hard brush. This may damage the surfaces of the lights.
- Do not apply wax to the surfaces of the lights. Wax may cause damage to the lenses.

■ **When using an automatic car wash (vehicles with rain-sensing windshield wipers)**

Set the wiper switch to the off position.  
If the wiper switch is in "AUTO", the wipers may operate and the wiper blades may be damaged.

■ **When using a high pressure car wash**

- When washing the vehicle, do not let water of the high pressure washer hit directly or the vicinity of the camera. Due to the shock from the high pressure water, it is possible the device may not operate as normal.
- Do not bring the nozzle tip close to boots (rubber or resin manufactured cover), connectors or the following parts. The parts may be damaged if they come into contact with high-pressure water.

- Traction related parts

- Steering parts
- Suspension parts
- Brake parts

- Keep the cleaning nozzle at least 11.9 in. (30 cm) away from the vehicle body. Otherwise resin section, such as moldings and bumpers, may be deformed and damaged.

Also, do not continuously hold the nozzle in the same place.

- Do not spray the lower part of the windshield continuously.

If water enters the air conditioning system intake located near the lower part of the windshield, the air conditioning system may not operate correctly.

## Cleaning and protecting the vehicle interior

Perform cleaning in a manner appropriate to each component and its material.

### Protecting the vehicle interior

- Remove dirt and dust using a vacuum cleaner. Wipe dirty surfaces with a cloth dampened with lukewarm water.
- If dirt cannot be removed, wipe it off with a soft cloth dampened with neutral detergent diluted to approximately 1%.  
Wring out any excess water from the cloth and thoroughly wipe off remaining traces of detergent and water.

#### ■ Shampooing the carpets

There are several commercial foaming-type cleaners available. Use a sponge or brush to apply the foam. Rub in overlapping circles. Do not use water. Wipe dirty surfaces and let them dry. Excellent results are obtained by keeping the carpet as dry as possible.

#### ■ Handling the seat belts

Clean with mild soap and lukewarm water using a cloth or sponge. Also check the belts periodically for excessive wear, fraying or cuts.

### WARNING

#### ■ Water in the vehicle

- Do not splash or spill liquid in the vehicle. Doing so may cause electrical components, etc. to malfunction or catch fire.
- Do not get any of the SRS components or wiring in the vehicle interior wet. (→P.32)  
An electrical malfunction may cause the airbags to deploy or not function properly, resulting in death or serious injury.
- Vehicles with wireless charger: Do not let the wireless charger (→P.368) get wet. Failure to do so may cause the charger to become hot and cause burns or could cause electric shock resulting in death or serious injury.

#### ■ Cleaning the interior (especially instrument panel)

Do not use polish wax or polish cleaner. The instrument panel may reflect off the windshield, obstructing the driver's view and leading to an accident, resulting in death or serious injury.

### NOTICE

#### ■ Cleaning detergents

- Do not use the following types of detergent, as they may discolor the vehicle interior or cause streaks or damage to painted surfaces:
  - Non-seat portions: Organic substances such as benzene or gasoline, alkaline or acidic solutions, dye, and bleach
  - Seats: Alkaline or acidic solutions, such as thinner, benzene, and alcohol



**NOTICE**

- Do not use polish wax or polish cleaner. The instrument panel's or other interior part's painted surface may be damaged.

■ **Preventing damage to leather surfaces**

Observe the following precautions to avoid damage to and deterioration of leather surfaces:

- Remove any dust or dirt from leather surfaces immediately.
- Do not expose the vehicle to direct sunlight for extended periods of time. Park the vehicle in the shade, especially during summer.
- Do not place items made of vinyl, plastic, or containing wax on the upholstery, as they may stick to the leather surface if the vehicle interior heats up significantly.

■ **Water on the floor**

Do not wash the vehicle floor with water.

Vehicle systems such as the audio system may be damaged if water comes into contact with electrical components such as the audio system above or under the floor of the vehicle. Water may also cause the body to rust.

■ **When cleaning the inside of the windshield**

Do not allow glass cleaner to contact the lens. Also, do not touch the lens. (→P.227)

■ **Cleaning the inside of the rear window**

- Do not use glass cleaner to clean the rear window, as this may cause damage to the rear window defogger heater wires or antenna. Use a cloth dampened with lukewarm water to gently wipe the window clean. Wipe the window in strokes running parallel to the heater wires or antenna.
- Be careful not to scratch or damage the heater wires or antenna.

**Cleaning the leather areas**

- Remove dirt and dust using a vacuum cleaner.
- Wipe off any excess dirt and dust with a soft cloth dampened with diluted detergent.

Use a diluted water solution of approximately 5% neutral wool detergent.

- Wring out any excess water from the cloth and thoroughly wipe off all remaining traces of detergent.
- Wipe the surface with a dry, soft cloth to remove any remaining moisture. Allow the leather to dry in a shaded and ventilated area.

■ **Caring for leather areas**

Toyota recommends cleaning the interior of the vehicle at least twice a year to maintain the quality of the vehicle's interior.



### **Cleaning the synthetic leather areas**

- Remove dirt and dust using a vacuum cleaner.
- Wipe it off with a soft cloth dampened with neutral detergent diluted to approximately 1%.
- Wring out any excess water from the cloth and thoroughly wipe off remaining traces of detergent and water.

### Maintenance requirements

**To ensure safe and economical driving, day-to-day care and regular maintenance are essential. It is the owner's responsibility to perform regular checks. Toyota recommends the following maintenance:**

#### ■ Repair and replacement

It is recommended that genuine Toyota parts be used for repairs to ensure performance of each system. If non-Toyota parts are used in replacement or if a repair shop other than a Toyota dealer performs repairs, confirm the warranty coverage.

#### ■ Allow inspection and repairs to be performed by a Toyota dealer

- Toyota technicians are well-trained specialists and are kept up to date with the latest service information. They are well informed about the operation of all systems on your vehicle.
- Keep a copy of the repair order. It proves that the maintenance that has been performed is under warranty coverage. If any problem should arise while your vehicle is under warranty, your Toyota dealer will promptly take care of it.

#### WARNING

##### ■ If your vehicle is not properly maintained

Improper maintenance could result in serious damage to the vehicle and possible death or serious injury.

#### ■ Handling of the battery

- Engine exhaust, some of its constituents, and a wide variety of automobile components contain or emit chemicals known to the State of California to cause cancer and birth defects and other reproductive harm. Work in a well ventilated area.
- Oils, fuels and fluids contained in vehicles as well as waste produced by component wear contain or emit chemicals known to the State of California to cause cancer and birth defects or other reproductive harm. Avoid exposure and wash any affected area immediately.
- Battery posts, terminals and related accessories contain lead and lead compounds which are known to cause brain damage. Wash your hands after handling. (→P.408)

### General maintenance

General maintenance should be performed on a daily basis. This can be done by yourself or by a Toyota dealer.

### Scheduled maintenance

Scheduled maintenance should be performed at specified intervals according to the maintenance schedule.

For details about maintenance items and schedules, refer to the "Scheduled Maintenance Guide" or "Owner's Manual Supplement".

### ■ Resetting the message indicating maintenance is required

After the required maintenance is performed according to the maintenance schedule, please reset the message. To reset the message, follow the procedures described below:

#### ▶ 4.2-inch display

- 1 Press or of the meter control switch to select .
- 2 Press or of the meter control switch, select and then press and hold .
- 3 Press or of the meter control switch, select "Scheduled Maintenance" and then press .
- 4 Select "Yes" and press .
- 5 A message will be displayed on the multi-information display when the reset procedure has been completed.

#### ▶ 7-inch display

- 1 Press or of the meter control switch to select .
- 2 Press or of the meter control switch, select and then press and hold .
- 3 Press or of the meter control switch, select "Scheduled Maintenance" and then press .
- 4 Select "Yes" and press .
- 5 A message will be displayed on the multi-information display when the reset procedure has been completed.

### Do-it-yourself maintenance

You can perform some maintenance procedures by yourself. Please be aware that do-it-yourself maintenance may affect warranty coverage.

The use of Toyota Repair Manuals is recommended.

For details about warranty coverage, refer to the separate "Owner's Warranty Information Booklet" or "Owner's Manual Supplement".

### General maintenance

Listed below are the general maintenance items that should be performed at the intervals specified in the “Owner’s Warranty Information Booklet” or “Owner’s Manual Supplement/Scheduled Maintenance Guide”. It is recommended that any problem you notice should be brought to the attention of your Toyota dealer or qualified service shop for advice.

#### WARNING

■ **If the engine is running**  
Turn the engine off and ensure that there is adequate ventilation before performing maintenance checks.

### Engine compartment

Items	Check points
Battery	Check the connections. (→P.408)
Brake fluid	Is the brake fluid at the correct level? (→P.408)
Engine coolant	Is the engine coolant at the correct level? (→P.407)
Engine oil	Is the engine oil at the correct level? (→P.404)

Items	Check points
Exhaust system	There should not be any fumes or strange sounds.
Radiator/condenser	The radiator and condenser should be free from foreign objects. (→P.408)
Washer fluid	Is there sufficient washer fluid? (→P.410)

### Vehicle interior

Items	Check points
Accelerator pedal	<ul style="list-style-type: none"> <li>The accelerator pedal should move smoothly (without uneven pedal effort or catching).</li> </ul>
Automatic transmission “Park” mechanism	<ul style="list-style-type: none"> <li>When parked on a slope and the shift lever is in P, is the vehicle securely stopped?</li> </ul>

Items	Check points
Brake pedal	<ul style="list-style-type: none"> <li>• Does the brake pedal move smoothly?</li> <li>• Does the brake pedal have appropriate clearance from the floor? (→P.499)</li> <li>• Does the brake pedal have the correct amount of free play? (→P.499)</li> </ul>
Brakes	<ul style="list-style-type: none"> <li>• The vehicle should not pull to one side when the brakes are applied.</li> <li>• The brakes should work effectively.</li> <li>• The brake pedal should not feel spongy.</li> <li>• The brake pedal should not get too close to the floor when the brakes are applied.</li> </ul>
Head restraints	<ul style="list-style-type: none"> <li>• Do the head restraints move smoothly and lock securely?</li> </ul>
Horn	<ul style="list-style-type: none"> <li>• Works properly?</li> </ul>
Indicators/buzzers	<ul style="list-style-type: none"> <li>• Do the indicators and buzzers function properly?</li> </ul>

Items	Check points
Lights	<ul style="list-style-type: none"> <li>• Do all the lights come on?</li> <li>• Are the headlights aimed correctly? (→P.431)</li> </ul>
Parking brake	<ul style="list-style-type: none"> <li>• Does the parking brake switch operate normally?</li> <li>• When parked on a slope and the parking brake is on, is the vehicle securely stopped?</li> </ul>
Seat belts	<ul style="list-style-type: none"> <li>• Do the seat belts operate smoothly?</li> <li>• The seat belts should not be damaged.</li> </ul>
Seats	<ul style="list-style-type: none"> <li>• Do the seat controls operate properly?</li> </ul>
Steering wheel	<ul style="list-style-type: none"> <li>• Does the steering wheel rotate smoothly?</li> <li>• Does the steering wheel have the correct amount of free play?</li> <li>• There should not be any strange sounds coming from the steering wheel.</li> </ul>

**Vehicle exterior**

Items	Check points
Doors	<ul style="list-style-type: none"> <li>Do the doors operate smoothly?</li> </ul>
Engine hood	<ul style="list-style-type: none"> <li>Does the engine hood lock system work properly?</li> </ul>
Fluid leaks	<ul style="list-style-type: none"> <li>There should not be any signs of fluid leakage after the vehicle has been parked.</li> </ul>
Tires	<ul style="list-style-type: none"> <li>Is the tire inflation pressure correct?</li> <li>The tires should not be damaged or excessively worn.</li> <li>Have the tires been rotated according to the maintenance schedule?</li> <li>The wheel nuts should not be loose.</li> </ul>
Windshield wipers/rear window wiper	<ul style="list-style-type: none"> <li>The wiper blades should not show any signs of cracking, splitting, wear, contamination or deformation.</li> <li>The wiper blades should clear the windshield/rear window without streaking or skipping.</li> </ul>

**Emission inspection and maintenance (I/M) programs**

Some states have vehicle emission inspection programs which include OBD (On Board Diagnostics) checks. The OBD system monitors the operation of the emission control system.

**If the malfunction indicator lamp comes on**

The OBD system determines that a problem exists somewhere in the emission control system. Your vehicle may not pass the I/M test and may need to be repaired. Contact your Toyota dealer to service the vehicle.

**Your vehicle may not pass the I/M test in the following situations:**

- When the battery is disconnected or discharged
- Readiness codes that are set during ordinary driving are erased. Also, depending on your driving habits, the readiness codes may not be completely set.
- When the fuel tank cap is loose

The malfunction indicator lamp comes on indicating a temporary malfunction and your vehicle may not pass the I/M test.

**When the malfunction indicator lamp still remains on after several driving trips**

The error code in the OBD system will not be cleared unless the vehicle is driven 40 or more times.

**If your vehicle does not pass the I/M test**

Contact your Toyota dealer to prepare the vehicle for re-testing.

**Do-it-yourself service precautions**

**If you perform maintenance by yourself, be sure to follow the correct procedure as given in these sections.**

**Maintenance**

Items	Parts and tools
Battery condition (→P.408)	<ul style="list-style-type: none"> <li>• Warm water</li> <li>• Baking soda</li> <li>• Grease</li> <li>• Conventional wrench (for terminal clamp bolts)</li> </ul>
Brake fluid level (→P.408)	<ul style="list-style-type: none"> <li>• FMVSS No.116 DOT 3 or SAE J1703 brake fluid</li> <li>• Rag or paper towel</li> <li>• Funnel (used only for adding brake fluid)</li> </ul>

Items	Parts and tools
Engine coolant level (→P.407)	<ul style="list-style-type: none"> <li>• “Toyota Super Long Life Coolant” or a similar high quality ethylene glycol-based non-silicate, non-amine, non-nitrite and non-borate coolant with long-life hybrid organic acid technology For the U.S.A.: “Toyota Super Long Life Coolant” is pre-mixed with 50% coolant and 50% deionized water. For Canada: “Toyota Super Long Life Coolant” is pre-mixed with 55% coolant and 45% deionized water.</li> <li>• Funnel (used only for adding coolant)</li> </ul>
Engine oil level (→P.404)	<ul style="list-style-type: none"> <li>• “Toyota Genuine Motor Oil” or equivalent</li> <li>• Rag or paper towel</li> <li>• Funnel (used only for adding engine oil)</li> </ul>
Fuses (→P.429)	<ul style="list-style-type: none"> <li>• Fuse with same amperage rating as original</li> </ul>



Items	Parts and tools
Headlight aim (→P.431)	<ul style="list-style-type: none"> <li>• Phillips-head screwdriver</li> </ul>
Light bulbs (→P.432)	<ul style="list-style-type: none"> <li>• Bulb with same number and wattage rating as original</li> <li>• Flathead screwdriver</li> <li>• Wrench</li> </ul>
Radiator and condenser (→P.408)	—
Tire inflation pressure (→P.423)	<ul style="list-style-type: none"> <li>• Tire pressure gauge</li> <li>• Compressed air source</li> </ul>
Washer fluid (→P.410)	<ul style="list-style-type: none"> <li>• Water or washer fluid containing antifreeze (for winter use)</li> <li>• Funnel (used only for adding water or washer fluid)</li> </ul>

**⚠ WARNING**

The engine compartment contains many mechanisms and fluids that may move suddenly, become hot, or become electrically energized. To avoid death or serious injury, observe the following precautions.

■ **When working on the engine compartment**

- Keep hands, clothing and tools away from the moving fan and engine drive belt.

- Be careful not to touch the engine, radiator, exhaust manifold, etc. right after driving as they may be hot. Oil and other fluids may also be hot.
- Do not leave anything that may burn easily, such as paper and rags, in the engine compartment.
- Do not smoke, cause sparks or expose an open flame to fuel or the battery. Fuel and battery fumes are flammable.
- Be extremely cautious when working on the battery. It contains poisonous and corrosive sulfuric acid.

■ **When working near the electric cooling fan or radiator grille**

Be sure the engine switch is off. With the engine switch in ON, the electric cooling fan may automatically start to run if the air conditioning is on and/or the coolant temperature is high. (→P.408)

■ **Safety glasses**

Wear safety glasses to prevent flying or falling material, fluid spray, etc. from getting in your eyes.

**⚠ NOTICE**

■ **If you remove the air cleaner filter**

Driving with the air cleaner filter removed may cause excessive engine wear due to dirt in the air.

## Hood

### Opening the hood

- 1 Pull the hood lock release lever.

The hood will pop up slightly.

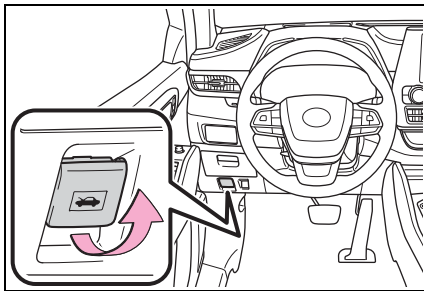

- 2 Pull up the auxiliary catch lever and lift the hood.

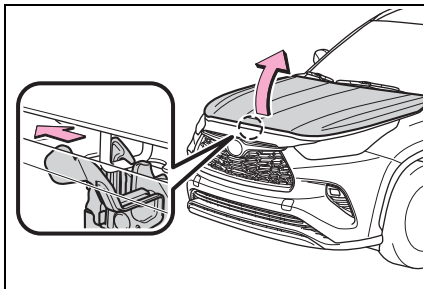

- 3 Hold the hood open by inserting the support rod into the slot.

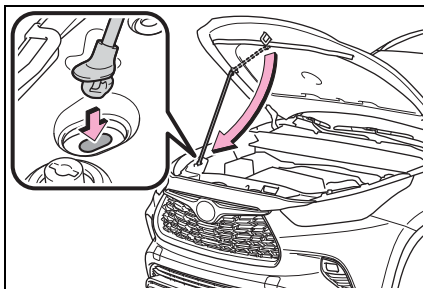

### ⚠ WARNING

#### ■ Pre-driving check

Check that the hood is fully closed and locked.

If the hood is not locked properly, it may open while the vehicle is in motion and cause an accident, which may result in death or serious injury.

#### ■ After installing the support rod into the slot

Make sure the rod supports the hood securely preventing it from falling down onto your head or body.

### ⚠ NOTICE

#### ■ When closing the hood

Be sure to return the support rod to its clip before closing the hood. Closing the hood with the support rod not clipped could cause the hood to bend.

### Positioning a floor jack

When using a floor jack, follow the instructions in the manual provided with the jack and perform the operation safely.

When raising your vehicle with a floor jack, position the jack correctly. Improper placement may damage your vehicle or cause injury.

### Location of the jack point

#### ■ Front

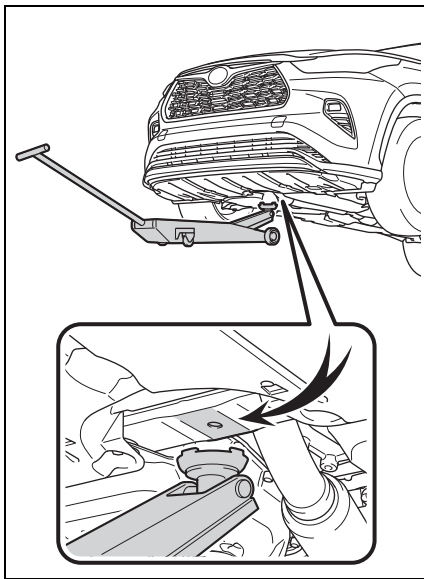

#### ■ Rear

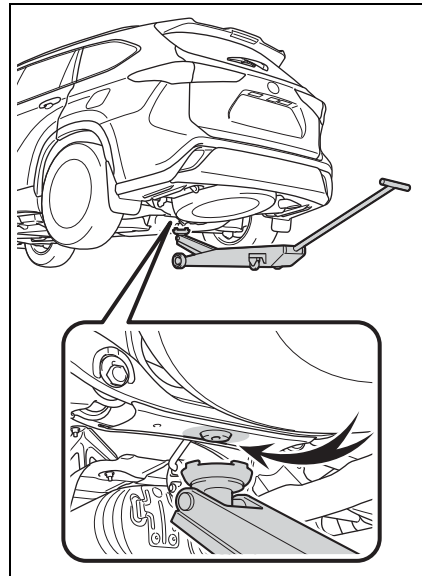

## Engine compartment

### Components

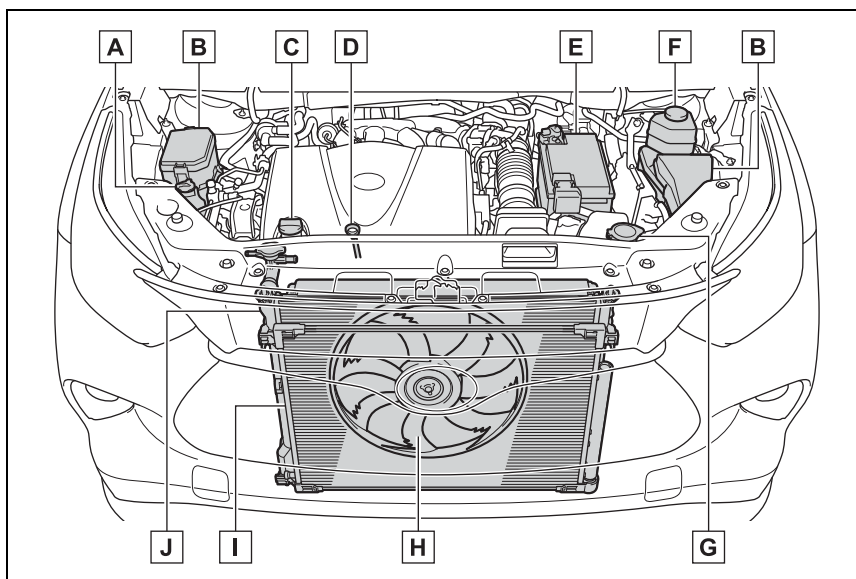

- A** Engine coolant reservoir (→P.407)
- B** Fuse boxes (→P.429)
- C** Engine oil filler cap (→P.405)
- D** Engine oil level dipstick (→P.404)
- E** Battery (→P.408)
- F** Brake fluid reservoir (→P.408)
- G** Washer fluid tank (→P.410)
- H** Electric cooling fan
- I** Condenser (→P.408)
- J** Radiator (→P.408)

### Checking and adding the engine oil

With the engine at operating temperature and turned off, check the oil level on the dip-

stick.

#### ■ Checking the engine oil

- 1 Park the vehicle on level ground. After warming up the engine and turning it off, wait

more than 5 minutes for the oil to drain back into the bottom of the engine.

- 2 Holding a rag under the end, pull the dipstick out.

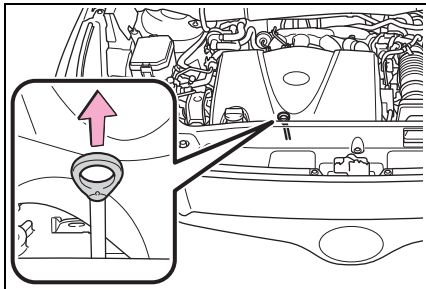

- 3 Wipe the dipstick clean.
- 4 Reinsert the dipstick fully.
- 5 Holding a rag under the end, pull the dipstick out and check the oil level.

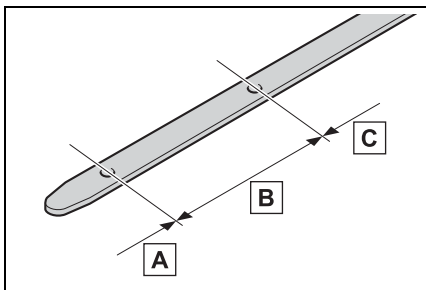

- A** Low
- B** Normal
- C** Excessive

The shape of the dipstick may differ depending on the type of vehicle or engine.

- 6 Wipe the dipstick and reinsert it fully.

■ **Checking the oil type and preparing the item needed**

Make sure to check the oil type and prepare the items needed before adding oil.

- Engine oil selection  
→P.495
- Oil quantity (Low → Full)  
1.9 qt. (1.8 L, 1.6 Imp. qt.)
- Item  
Clean funnel

■ **Adding engine oil**

If the oil level is below or near the low level mark, add engine oil of the same type as that already in the engine.

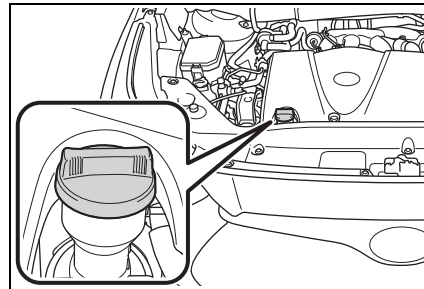

- 1 Remove the oil filler cap by turning it counterclockwise.
- 2 Add engine oil slowly, checking the dipstick.
- 3 Install the oil filler cap by turning it clockwise.

■ **Engine oil consumption**

A certain amount of engine oil will be consumed while driving. In the following situations, oil consumption may increase, and engine oil may need to be refilled in between oil maintenance intervals.

- When the engine is new, for example directly after purchasing the vehicle or after replacing the engine
- If low quality oil or oil of an inappropriate viscosity is used
- When driving at high engine speeds or with a heavy load, when towing, or when driving while accelerating or decelerating frequently
- When leaving the engine idling for a long time, or when driving frequently through heavy traffic





■ **If the oil is spilled on the engine cover**

To prevent the engine cover from being damaged, remove any engine oil from the engine cover as soon as possible using a neutral detergent. Do not use an organic solvent such as brake cleaner.

■ **After changing the engine oil**





The engine oil maintenance data should be reset. Perform the following procedures:

▶ 4.2-inch display

- 1 Press < or > of the meter control switch to select .
- 2 Press ^ or v of the meter control switch, select  and then press and hold .
- 3 Press ^ or v of the meter control switch, select “Oil Maintenance” and then press .
- 4 Select “Yes” and press .
- 5 A message will be displayed on the multi-information display when the reset procedure has been completed.

▶ 7-inch display

- 1 Press ^ or v of the meter control switch to select .

- 2 Press < or > of the meter control switch, select  and then press and hold .
- 3 Press ^ or v of the meter control switch, select “Oil Maintenance” and then press .
- 4 Select “Yes” and press .
- 5 A message will be displayed on the multi-information display when the reset procedure has been completed.

 **WARNING**

■ **Used engine oil**

- Used engine oil contains potentially harmful contaminants which may cause skin disorders such as inflammation and skin cancer, so care should be taken to avoid prolonged and repeated contact. To remove used engine oil from your skin, wash thoroughly with soap and water.
- Dispose of used oil and filters only in a safe and acceptable manner. Do not dispose of used oil and filters in household trash, in sewers or onto the ground. Call your Toyota dealer, service station or auto parts store for information concerning recycling or disposal.
- Do not leave used engine oil within the reach of children.

 **NOTICE**

■ **To prevent serious engine damage**

Check the oil level on a regular basis.

 **NOTICE**

- **When replacing the engine oil**
- Be careful not to spill engine oil on the vehicle components.
- Avoid overfilling, or the engine could be damaged.
- Check the oil level on the dipstick every time you refill the vehicle.
- Be sure the engine oil filler cap is properly tightened.

**Checking the coolant**

The coolant level is satisfactory if it is between the “FULL” and “LOW” lines on the reservoir when the engine is cold.

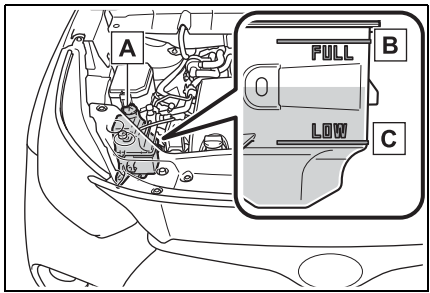

- A** Reservoir cap
- B** “FULL” line
- C** “LOW” line

If the level is on or below the “LOW” line, add coolant up to the “FULL” line. (→P.487)

■ **Coolant selection**

Only use “Toyota Super Long Life Coolant” or a similar high quality ethylene glycol based non-silicate, non-amine, non-nitrite, and non-borate coolant with long-life hybrid organic acid technology.

U.S.A.:  
 “Toyota Super Long Life Coolant” is a mixture of 50% coolant and 50% deionized water. (Minimum temperature: -31°F [-35°C])

Canada:  
 “Toyota Super Long Life Coolant” is a mixture of 55% coolant and 45% deionized water. (Minimum temperature: -44°F [-42°C])

For more details about coolant, contact your Toyota dealer.

■ **If the coolant level drops within a short time of replenishing**

Visually check the radiator, hoses, engine coolant reservoir cap, drain cock and water pump. If you cannot find a leak, have your Toyota dealer test the cap and check for leaks in the cooling system.

 **WARNING**

- **When the engine is hot**

Do not remove the engine coolant reservoir cap and radiator cap.

The cooling system may be under pressure and may spray hot coolant if the cap is removed, causing serious injuries, such as burns.

 **NOTICE**

- **When adding coolant**

Coolant is neither plain water nor straight antifreeze. The correct mixture of water and antifreeze must be used to provide proper lubrication, corrosion protection and cooling. Be sure to read the antifreeze or coolant label.

- **If you spill coolant**

Be sure to wash it off with water to prevent it from damaging parts or paint.

### Checking the radiator and condenser

Check the radiator and condenser and clear away any foreign objects. If either of the above parts is extremely dirty or you are not sure of their condition, have your vehicle inspected by your Toyota dealer.

#### WARNING

##### ■ When the engine is hot

Do not touch the radiator or condenser as they may be hot and cause serious injuries, such as burns.

### Checking and adding the brake fluid

#### ■ Checking fluid level

The brake fluid level should be between the "MAX" and "MIN" lines on the tank.

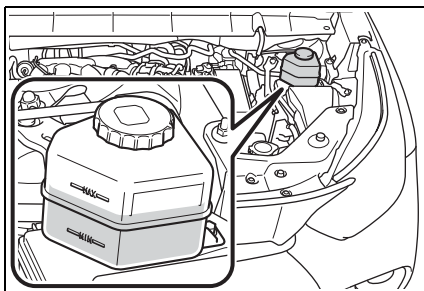

#### ■ Adding fluid

Make sure to check the fluid type and prepare the necessary item.

- Fluid type

SAE J1703 or FMVSS No.116 DOT 3 brake fluid

- Item  
Clean funnel

#### ■ Brake fluid can absorb moisture from the air

Excess moisture in the brake fluid can cause a dangerous loss of braking efficiency. Use only newly opened brake fluid.

#### WARNING

##### ■ When filling the reservoir

Take care as brake fluid can harm your hands and eyes and damage painted surfaces.

If fluid gets on your hands or in your eyes, flush the affected area with clean water immediately.

If you still experience discomfort, see a doctor.

#### NOTICE

##### ■ If the fluid level is low or high

It is normal for the brake fluid level to go down slightly as the brake pads wear out or when the fluid level in the accumulator is high. If the reservoir needs frequent refilling, there may be a serious problem.

### Battery

Check the battery as follows.

#### ■ Battery exterior

Make sure that the battery terminals are not corroded and that there are no loose connections, cracks, or loose clamps.



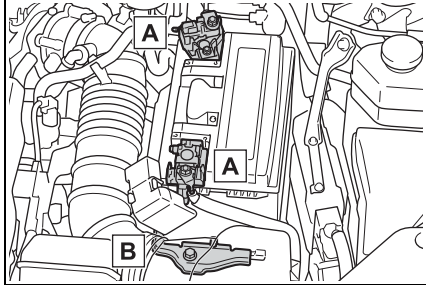

- A** Terminals  
**B** Hold-down clamp

#### ■ Before recharging

When recharging, the battery produces hydrogen gas which is flammable and explosive. Therefore, observe the following precautions before recharging:

- If recharging with the battery installed on the vehicle, be sure to disconnect the ground cable.
- Make sure the power switch on the charger is off when connecting and disconnecting the charger cables to the battery.

#### ■ After recharging/reconnecting the battery

- The engine may not start. Follow the procedure below to initialize the system.
  - 1 Shift the shift lever to P.
  - 2 Open and close any of the doors.
  - 3 Restart the engine.
- Unlocking the doors using the smart key system may not be possible immediately after reconnecting the battery. If this happens, use the wireless remote control or the mechanical key to lock/unlock the doors.
- Start the engine with the engine switch in ACC. The engine may not start with the engine switch turned off. However, the engine will operate normally from the second attempt.

- The engine switch mode is recorded by the vehicle. If the battery is disconnected and reconnected, the vehicle will return the engine switch mode to the status it was in before the battery was disconnected. Make sure to turn off the engine before disconnecting the battery. Take extra care when connecting the battery if the engine switch mode prior to the battery being disconnected is unknown.

If the system will not start even after multiple attempts, contact your Toyota dealer.

#### **⚠ WARNING**

##### ■ Chemicals in the battery

Batteries contain poisonous and corrosive sulfuric acid and may produce hydrogen gas which is flammable and explosive. To reduce the risk of death or serious injury, take the following precautions while working on or near the battery:

- Do not cause sparks by touching the battery terminals with tools.
- Do not smoke or light a match near the battery.
- Avoid contact with eyes, skin and clothes.
- Never inhale or swallow electrolyte.
- Wear protective safety glasses when working near the battery.
- Keep children away from the battery.

**⚠ WARNING**

■ **Where to safely charge the battery**

Always charge the battery in an open area. Do not charge the battery in a garage or closed room where there is insufficient ventilation.

■ **How to recharge the battery**

Only perform a slow charge (5 A or less). The battery may explode if charged at a quicker rate.

■ **Emergency measures regarding electrolyte**

- If electrolyte gets in your eyes  
Flush your eyes with clean water for at least 15 minutes and get immediate medical attention. If possible, continue to apply water with a sponge or cloth while traveling to the nearest medical facility.
- If electrolyte gets on your skin  
Wash the affected area thoroughly. If you feel pain or burning, get medical attention immediately.
- If electrolyte gets on your clothes  
It can soak through clothing on to your skin. Immediately take off the clothing and follow the procedure above if necessary.
- If you accidentally swallow electrolyte  
Drink a large quantity of water or milk. Get emergency medical attention immediately.

**⚠ NOTICE**

■ **When recharging the battery**

Never recharge the battery while the engine is running. Also, be sure all accessories are turned off.

**Washer fluid**

If any washer does not work or the warning message appears on the multi-information display, the washer tank may be empty. Add washer fluid.

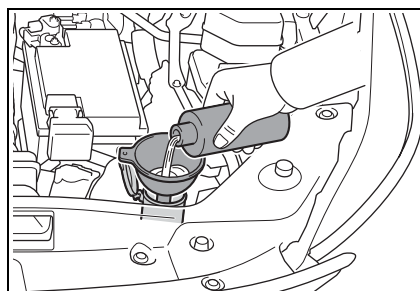

**⚠ WARNING**

■ **When adding washer fluid**

Do not add washer fluid when the engine is hot or running as washer fluid contains alcohol and may catch fire if spilled on the engine, etc.

**⚠ NOTICE**

■ **Do not use any fluid other than washer fluid**

Do not use soapy water or engine antifreeze instead of washer fluid. Doing so may cause streaking on the vehicle's painted surfaces, as well as damaging the pump leading to problems of the washer fluid not spraying.

■ **Diluting washer fluid**

Dilute washer fluid with water as necessary. Refer to the freezing temperatures listed on the label of the washer fluid bottle.

**Tires**

**Replace or rotate tires in accordance with maintenance schedules and treadwear.**

**Checking tires**

Check if the treadwear indicators are showing on the tires. Also check the tires for uneven wear, such as excessive wear on one side of the tread.

Check the spare tire condition and pressure if not rotated.

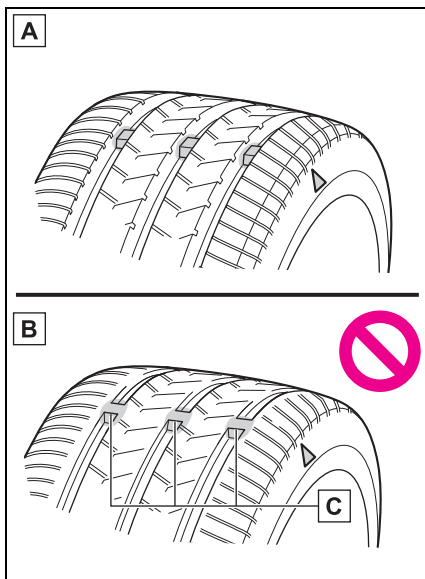

- A** New tread
  - B** Worn tread
  - C** Treadwear indicator
- The location of treadwear indicators is shown by a “TWI” or “△” mark,

etc., molded into the sidewall of each tire.

Replace the tires if the treadwear indicators are showing on a tire.

**When to replace your vehicle's tires**

Tires should be replaced if:

- The treadwear indicators are showing on a tire.
- You have tire damage such as cuts, splits, cracks deep enough to expose the fabric, and bulges indicating internal damage.
- A tire goes flat repeatedly or cannot be properly repaired due to the size or location of a cut or other damage.

If you are not sure, consult with your Toyota dealer.

**Tire life**

Any tire over 6 years old must be checked by a qualified technician even if it has seldom or never been used or damage is not obvious.

**Proper storage of the spare tire**

As an improperly stored spare tire may cause damage to the wire cable that holds it, check that the spare tire is stored properly on a daily basis.

- If the stored spare tire appears to be slanted or rattles while driving, the spare tire may not be properly stored. Store the spare tire again by performing the following tire change procedure correctly:

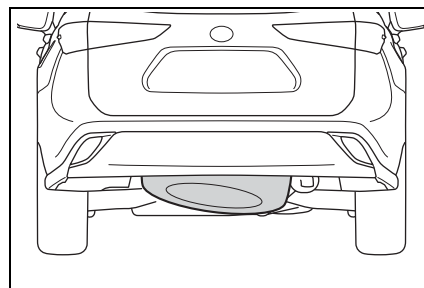

- 1 If the spare tire is slanted, the hoist assembly may be stuck in the wheel opening. If the spare tire rattles while driving, it may not be fully raised. Lower the spare tire to the ground and make sure that the hoist assembly is perpendicular to the wheel opening.
- 2 Raise the tire slowly and steadily until a click is heard and the jack handle skips.

If the spare tire cannot be lowered, the wire cable may be severed. Have the vehicle inspected at your Toyota dealer.

■ **Maximum load of tire**

Check that the number given by dividing the maximum load by 1.10 of the replacement tire is greater than 1/2 of the Gross Axle Weight Ratings (GAWR) of either the front axle or the rear axle, whichever is greater.

For the GAWR, see the Certification Label.

For the maximum load of the tire, see the load limit at maximum cold tire inflation pressure mentioned on the sidewall of the tire. (→P.505)

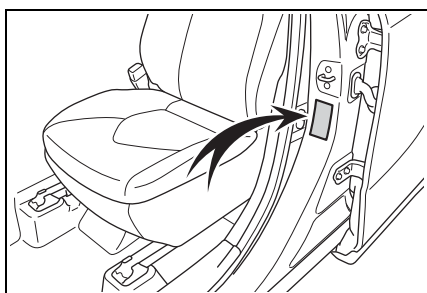

■ **Tire types**

● **Summer tires**

Summer tires are high-speed performance tires best suited to highway driving under dry conditions. Since summer tires do not have the same traction performance as snow tires, summer tires are inadequate for

driving on snow-covered or icy roads. For driving on snow-covered roads or icy roads, the use of snow tires is recommended. When installing snow tires, be sure to replace all four tires.

● **All season tires**

All season tires are designed to provide better traction in snow and to be adequate for driving in most winter conditions as well as for use year-round. All season tires, however, do not have adequate traction performance compared with snow tires in heavy or loose snow. Also, all season tires fall short in acceleration and handling performance compared with summer tires in highway driving.

● **Snow tires**

For driving on snow-covered roads or icy roads, we recommend using snow tires. If you need snow tires, select tires of the same size, construction and load capacity as the originally installed tires. Since your vehicle has radial tires as original equipment, make sure your snow tires also have radial construction. Do not install studded tires without first checking local regulations for possible restrictions. Snow tires should be installed on all wheels. (→P.319)

■ **If the tread on snow tires wears down below 0.16 in. (4 mm)**

The effectiveness of the tires as snow tires is lost.

**⚠ WARNING**

■ **When inspecting or replacing tires**

Observe the following precautions to prevent accidents. Failure to do so may cause damage to parts of the drive train as well as dangerous handling characteristics, which may lead to an accident resulting in death or serious injury.

- Do not mix tires of different makes, models or tread patterns. Also, do not mix tires of remarkably different treadwear.
- Do not use tire sizes other than those recommended by Toyota.
- Do not mix differently constructed tires (radial, bias-belted or bias-ply tires).
- Do not mix summer, all season and snow tires.
- Do not use tires that have been used on another vehicle. Do not use tires if you do not know how they were used previously.
- Vehicles with a compact spare tire: Do not tow if your vehicle has a compact spare tire installed.

**⚠ NOTICE**

■ **Driving on rough roads**

Take particular care when driving on roads with loose surfaces or potholes. These conditions may cause losses in tire inflation pressure, reducing the cushioning ability of the tires. In addition, driving on rough roads may cause damage to the tires themselves, as well as the vehicle's wheels and body.

■ **If tire inflation pressure of each tire becomes low while driving**

Do not continue driving, or your tires and/or wheels may be ruined.

**Tire rotation**

Rotate the tires in the order shown.

- ▶ Vehicles with a compact spare tire

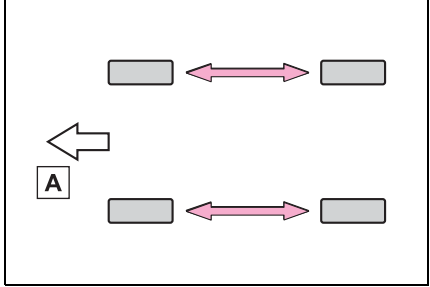

- ▶ Vehicles with a full-size spare tire

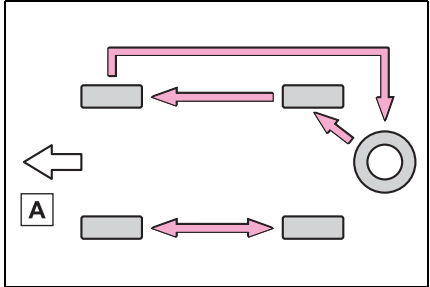

- ▶ **A Front**
- To equalize tire wear and extend tire life, Toyota recommends that tire rotation is carried out at the same interval as tire inspection. Do not fail to initialize the tire pres-

sure warning system after tire rotation.

### Tire pressure warning system

Your vehicle is equipped with a tire pressure warning system that uses tire pressure warning valves and transmitters to detect low tire inflation pressure before serious problems arise.

- The tire pressure detected by the tire pressure warning system can be displayed on the multi-information display. (→P.82, 91)

The illustration used is intended as an example, and may differ from the image that is actually displayed on the multi-information display.

▶ 4.2-inch display

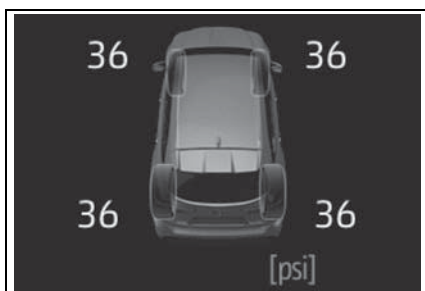

▶ 7-inch display

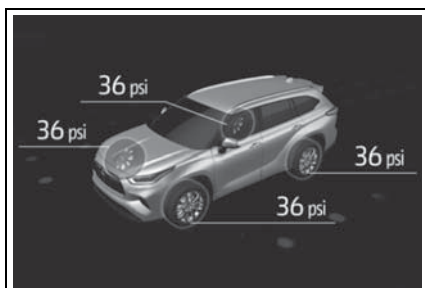

- If the tire pressure drops below a predetermined level, the driver is warned by a screen display and a warning light. (→P.454)

The illustration used is intended as an example, and may differ from the image that is actually displayed on the multi-information display.

▶ 4.2-inch display

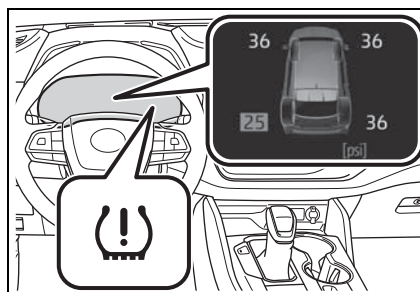

▶ 7-inch display

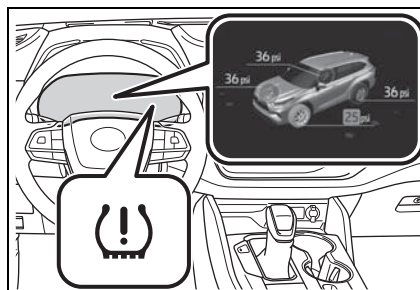

### Routine tire inflation pressure checks

The tire pressure warning system does not replace routine tire inflation pressure checks. Make sure to check tire inflation pressure as part of your routine of daily vehicle checks.

### Situations in which the tire pressure warning system may not operate properly

- In the following cases, the tire pressure warning system may not

- operate properly.
- If non-genuine Toyota wheels are used.
- A tire has been replaced with a tire that is not an OE (Original Equipment) tire.
- A tire has been replaced with a tire that is not of the specified size.
- Tire chains, etc. are equipped.
- An auxiliary-supported run-flat tire is equipped.
- If a window tint that affects the radio wave signals is installed.
- If there is a lot of snow or ice on the vehicle, particularly around the wheels or wheel housings.
- If the tire inflation pressure is extremely higher than the specified level.
- If the spare tire is in a location subject to poor radio wave signal reception.\*
- If wheel without the tire pressure warning valve and transmitter is used.
- If the ID code on the tire pressure warning valves and transmitters is not registered in the tire pressure warning computer.

\*: Vehicles with full-size spare tire only

- Performance may be affected in the following situations.
- Near a TV tower, electric power plant, gas station, radio station, large display, airport or other facility that generates strong radio waves or electrical noise
- When carrying a portable radio, cellular phone, cordless phone or other wireless communication device
- If tire position information is not correctly displayed due to the radio wave conditions, the display may be corrected by driving and changing the radio wave conditions.
- When the vehicle is parked, the time taken for the warning to start or go off could be extended.

- When tire inflation pressure declines rapidly for example when a tire has burst, the warning may not function.

#### ■ Warning performance of the tire pressure warning system

The warning of the tire pressure warning system will change in accordance with the conditions under which it was initialized. For this reason, the system may give a warning even if the tire pressure does not reach a low enough level, or if the pressure is higher than the pressure that was adjusted to when the system was initialized.

■ **Tire pressure warning system certification**

<TPM Sensor>  
BCS Access Systems

TPM Sensor  
Model: 338130 / 335098  
FCC ID: GQ4-75T / GQ4-72T  
IC: 1470A-56T / 1470A-53T  
MADE IN U.S.A.

This device complies with Part 15 of the FCC Rules and with RSS Standards of Industry Canada. Operation is subject to the following two conditions:  
(1) This device may not cause harmful interference, and  
(2) This device must accept any interference received, including interference that may cause undesired operation.

Le present appareil est conforme aux CNR d' Industrie Canada applicable aux appareils radio exempts de licence.  
L' exploitation est autorisee aux deux conditions suivantes:  
(1) L' appareil ne doit pas produire de brouillage.  
(2) L' utilisateur de l' appareil doit accepter tout brouillage radioelectrique subi, meme si le brouillage est susceptible d' en compromettre le fonctionnement.

WARNING: Changes or modifications not expressly approved by BCS Access Systems U.S. LLC could void the user's authority to operate the equipment.

The term "IC:" before the radio certification number only signifies that Industry Canada technical specifications were met.

(About Battery of TPM Sensor)  
CR Coin Lithium Battery contains Perchlorate Material - special handling may apply,  
See [www.dtsc.ca.gov/hazardouswaste/perchlorate](http://www.dtsc.ca.gov/hazardouswaste/perchlorate).

<TPMS/SMART Integrated Receiver>  
BCS Access Systems

TPMS/SMART Integrated Receiver  
Model: 338721  
FCC ID: GQ4-51R  
CAN RSS-GEN/CNR-GEN  
MADE IN U.S.A.

This device complies with Part 15 of the FCC Rules and with Canada license-exempt RSS standard(s). Operation is subject to the following two conditions:  
(1) This device may not cause harmful interference, and  
(2) This device must accept any interference received, including interference that may cause undesired operation.  
Le present appareil est conforme aux CNR d' Industrie Canada applicable aux appareils radio exempts de licence.  
L' exploitation est autorisee aux deux conditions suivantes:  
(1) L' appareil ne doit pas produire de brouillage.  
(2) L' utilisateur de l' appareil doit accepter tout brouillage radioelectrique subi, meme si le brouillage est susceptible d' en compromettre le fonctionnement.

WARNING: Changes or modifications not expressly approved by BCS Access Systems US, LLC could void the user's authority to operate the equipment.

**Installing tire pressure warning valves and transmitters**

When replacing tires or wheels, tire pressure warning valves and transmitters must also be



installed.

When new tire pressure warning valves and transmitters are installed, new ID codes must be registered in the tire pressure warning computer and the tire pressure warning system must be initialized. Have tire pressure warning valves and transmitter ID codes registered by your Toyota dealer. (→P.420)

#### ■ Replacing tires and wheels

If the ID code of the tire pressure warning valve and transmitter is not registered, the tire pressure warning system will not work properly. After driving for about 20 minutes, the tire pressure warning light blinks for 1 minute and stays on to indicate a system malfunction.



#### NOTICE

##### ■ Repairing or replacing tires, wheels, tire pressure warning valves, transmitters and tire valve caps

- When removing or fitting the wheels, tires or the tire pressure warning valves and transmitters, contact your Toyota dealer as the tire pressure warning valves and transmitters may be damaged if not handled correctly.
- Make sure to install the tire valve caps. If the tire valve caps are not installed, water could enter the tire pressure warning valves and the tire pressure warning valves could be bound.
- When replacing tire valve caps, do not use tire valve caps other than those specified. The cap may become stuck.

##### ■ To avoid damage to the tire pressure warning valves and transmitters

When a tire is repaired with liquid sealants, the tire pressure warning valve and transmitter may not operate properly. If a liquid sealant is used, contact your Toyota dealer or other qualified service shop as soon as possible. Make sure to replace the tire pressure warning valve and transmitter when replacing the tire. (→P.416)

#### Initializing the tire pressure warning system

##### ■ The tire pressure warning system must be initialized in the following circumstances:

- When the tire inflation pressure is changed such as when changing traveling speed.
- When the tire inflation pressure is changed such as when the tire size is changed.
- When rotating the tires.
- After registering the ID codes. (→P.420)

When the tire pressure warning system is initialized, the current tire inflation pressure is set as the benchmark pressure.

■ **How to initialize the tire pressure warning system**





▶ 4.2-inch display

- 1 Park the vehicle in a safe place and turn the engine switch off.

Initialization cannot be performed while the vehicle is moving.

- 2 Adjust the tire inflation pressure to the specified cold tire inflation pressure level. (→P.499)

Make sure to adjust the tire pressure to the specified cold tire inflation pressure level. The tire pressure warning system will operate based on this pressure level.

- 3 Turn the engine switch to ON.
- 4 Press < or > of the meter control switch to select .
- 5 Press ^ or v of the meter control switch, select  and then press and hold .
- 6 Press ^ or v of the meter control switch, select "TPWS" and then press .
- 7 Press ^ or v of the meter control switch, select "Set Pressure" and then press and hold .

▶ 7-inch display





- 1 Park the vehicle in a safe place and turn the engine switch off.

Initialization cannot be performed

while the vehicle is moving.

- 2 Adjust the tire inflation pressure to the specified cold tire inflation pressure level. (→P.499)

Make sure to adjust the tire pressure to the specified cold tire inflation pressure level. The tire pressure warning system will operate based on this pressure level.

- 3 Turn the engine switch to ON.
- 4 Press ^ or v of the meter control switch to select .
- 5 Press < or > of the meter control switch, select  and then press and hold .
- 6 Press ^ or v of the meter control switch, select "TPWS" and then press .
- 7 Press ^ or v of the meter control switch, select "Set Pressure" and then press and hold .

"Setting Tire Pressure Warning System" will be displayed on the multi-information display and the tire pressure warning light will blink 3 times.

When the message disappears, initialization is complete.

A message is displayed on the multi-information display. Also, "--" is displayed for inflation pressure of each tire on the multi-information display while

the tire pressure warning system determines the position.

Drive the vehicle at approximately 25 mph (40 km/h) or more for approximately 10 to 30 minutes until the inflation pressure of each tire is displayed on the multi-information display.

When initialization is complete, the inflation pressure of each tire will be displayed on the multi-information display.

Even if the vehicle is not driven at approximately 25 mph (40 km/h) or more, initialization can be completed by driving for a long time. However, if initialization does not complete after driving for 1 hour or more, park the vehicle in a safe place for approximately 20 minutes and then drive the vehicle again.

#### ■ Initializing the tire pressure warning system

Initialize the system with the tire inflation pressure adjusted to the specified level.

#### ■ Initialization procedure

- Make sure to carry out initialization after adjusting the tire inflation pressure.  
Also, make sure the tires are cold before carrying out initialization or tire inflation pressure adjustment.
- If you have accidentally turned the engine switch off during initialization, it is not necessary to restart the initialization again as initialization will restart automatically when the engine switch has been turned to ON for the next time.
- If you accidentally restart the ini-

tialization when initialization is not necessary, adjust the tire inflation pressure to the specified level when the tires are cold, and conduct initialization again.

- While the position of each tire is being determined and the inflation pressures are not being displayed on the multi-information display, if the inflation pressure of a tire drops, the tire pressure warning light will come on.

#### ■ When initialization of the tire pressure warning system has failed

Initialization may take longer to complete if the vehicle is driven on an unpaved road. When performing initialization, drive on a paved road if possible. Depending on the driving environment and condition of the tires, initialization will be completed in approximately 10 to 30 minutes. If initialization is not complete after driving approximately 10 to 30 minutes, continue driving for a while.

If the inflation pressure of each tire is not displayed after driving for approximately 1 hour, perform the following procedure.

- Park the vehicle in a safe place for approximately 20 minutes. Then drive straight (with occasional left and right turns) at approximately 25 mph (40 km/h) or more for approximately 10 to 30 minutes.

However, in the following situations, the tire inflation pressure will not be recorded and the system will not operate properly. Perform initialization again.

- If the vehicle is reversed during initialization, the data up to that point is reset, so perform the initialization procedure again from the beginning.
- When operating the tire pressure warning reset switch, the tire pressure warning light does not blink 3 times.

- After performing initialization, the tire pressure warning light blinks for 1 minute then stays on while driving.

If the inflation pressure of each tire is still not displayed, have the vehicle inspected by your Toyota dealer.

**⚠ WARNING**

**■ When initializing the tire pressure warning system**

Do not initialize tire inflation pressure without first adjusting the tire inflation pressure to the specified level. Otherwise, the tire pressure warning light may not come on even if the tire inflation pressure is low, or it may come on when the tire inflation pressure is actually normal.

**Registering ID codes**

Every tire pressure warning valve and transmitter has a unique ID code. When replacing a tire pressure warning valve and transmitter, it is necessary to register the ID code. When registering the ID codes, perform the following procedure.

▶ 4.2-inch display





- 1 Park the vehicle in a safe place and turn the engine switch off.

Initialization cannot be performed while the vehicle is moving.

- 2 Adjust the tire inflation pressure to the specified cold tire inflation pressure level. (→P.499)

Make sure to adjust the tire pressure to the specified cold tire infla-

tion pressure level. The tire pressure warning system will operate based on this pressure level.

- 3 Turn the engine switch to ON.
- 4 Press < or > of the meter control switch to select .
- 5 Press ^ or v of the meter control switch, select  and then press and hold .
- 6 Press ^ or v of the meter control switch, select "TPWS" and then press .
- 7 Press ^ or v of the meter control switch, select "Change Wheel" and then press  until the tire pressure warning light starts slowly blinking 3 times.

The change wheel set mode is activated and registration is started.

Then a message will be displayed on the multi-information display. When registration is being performed, the tire pressure warning light will blink for approximately 1 minute then illuminate and "--" will be displayed for the inflation pressure of each tire on the multi-information display.

- 8 Drive the vehicle at approximately 25mph (40 km/h) or more for approximately 10 to 30 minutes.

When registration is completed, the tire pressure warning light will go off and the inflation pressure of each tire will be displayed on the multi-information display.

Even if the vehicle is not driven at approximately 25 mph (40 km/h) or more, registration can be completed by driving for a long time. However, if registration does not complete after driving for 1 hour or more, perform the procedure again from the beginning.

**9** Initialize the tire pressure warning system. (→P.418)





▶ 7-inch display

- 1** Park the vehicle in a safe place and turn the engine switch off.

Initialization cannot be performed while the vehicle is moving.

- 2** Adjust the tire inflation pressure to the specified cold tire inflation pressure level. (→P.499)

Make sure to adjust the tire pressure to the specified cold tire inflation pressure level. The tire pressure warning system will operate based on this pressure level.

- 3** Turn the engine switch to ON.
- 4** Press  $\wedge$  or  $\vee$  of the meter control switch to select .
- 5** Press  $\langle$  or  $\rangle$  of the meter control switch, select  and then press and hold .
- 6** Press  $\wedge$  or  $\vee$  of the meter control switch, select "TPWS" and then press .
- 7** Press  $\wedge$  or  $\vee$  of the meter control switch, select "Change Wheel" and then

press  until the tire pressure warning light starts slowly blinking 3 times.

The change wheel set mode is activated and registration is started.

Then a message will be displayed on the multi-information display. When registration is being performed, the tire pressure warning light will blink for approximately 1 minute then illuminate and "--" will be displayed for the inflation pressure of each tire on the multi-information display.

- 8** Drive the vehicle at approximately 25mph (40 km/h) or more for approximately 10 to 30 minutes.

When registration is completed, the tire pressure warning light will go off and the inflation pressure of each tire will be displayed on the multi-information display.

Even if the vehicle is not driven at approximately 25 mph (40 km/h) or more, registration can be completed by driving for a long time. However, if registration does not complete after driving for 1 hour or more, perform the procedure again from the beginning.

- 9** Initialize the tire pressure warning system. (→P.418)

■ **When registering ID codes**

- ID code registration is performed while driving at a vehicle speed of approximately 25 mph (40 km/h) or more.
- Before performing ID code registration, make sure that no wheels with tire pressure warning valve and transmitters installed are near the vehicle.
- Make sure to initialize the tire pressure warning system after

registering the ID codes. If the system is initialized before registering the ID codes, the initialized values will be invalid.

- ID codes can be registered by yourself, but depending on the driving conditions and driving environment, registration may take some time to complete.

■ **Canceling ID code registration**

- To cancel ID code registration after it has been started, turn the engine switch off before driving the vehicle. If the vehicle is driven after ID code registration is started, to cancel registration, perform the ID code registration start procedure again and turn the engine switch off before driving.
- If ID code registration has been canceled, the tire pressure warning light will blink for approximately 1 minute when the engine switch is turned to ON and then illuminate. The tire pressure warning system will be operational when the tire pressure warning light turns off.
- If the warning light does not turn off even after several minutes have elapsed, ID code registration may not have been canceled correctly. To cancel registration, perform the ID code registration start procedure again and then turn the engine switch off before driving.

■ **If ID codes are not registered properly**

In the following situations, ID code registration may take longer than usual to be completed or may not be possible. Normally, registration completes within approximately 30 minutes.

- Vehicle is not parked for approximately 20 minutes or more before driving
- Vehicle is not driven at approximately 25 mph (40 km/h) or more
- Vehicle is driven on unpaved

roads

- Vehicle is driven near other vehicles and system cannot recognize tire pressure warning valve and transmitters of your vehicle over those of other vehicles

Wheel with tire pressure warning valve and transmitter installed is inside or near the vehicle

If registration does not complete after driving for 1 hour or more, perform the ID code registration procedure again from the beginning.

- If the vehicle is reversed during registration, the data up to that point is reset, so perform the registration procedure again from the beginning.
- In the following situations, ID code registration will not be started or was not completed properly and the system will not operate properly. Perform the ID code registration procedure again.
  - If, when attempting to start ID code registration, the tire pressure warning light does not blink slowly 3 times.
  - If, when the vehicle has been driven for about 20 minutes after performing ID code registration, the tire pressure warning light blinks for approximately 1 minute and then illuminates.

If the ID codes cannot be registered even when performing the above procedure, contact your Toyota dealer.

**Tire inflation pressure**

**Checking the specified tire inflation pressure**

The recommended cold tire inflation pressure and tire size are displayed on the tire and loading information label. (→P.499)

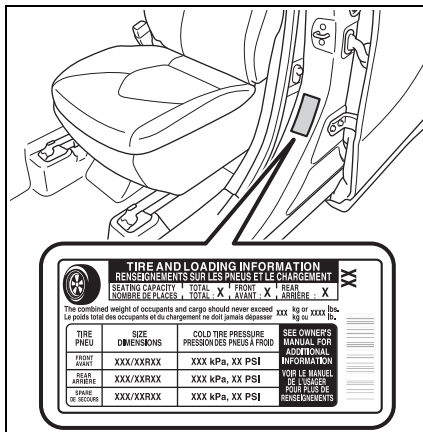

**Inspection and adjustment procedure**

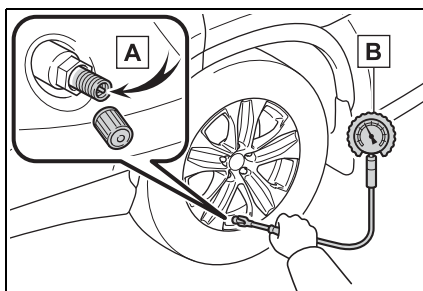

**A** Tire valve

**B** Tire pressure gauge

**1** Remove the tire valve cap.

- 2** Press the tip of the tire pressure gauge onto the tire valve.
- 3** Read the pressure using the gauge gradations.
- 4** If the tire inflation pressure is not at the recommended level, adjust the pressure. If you add too much air, press the center of the valve to deflate.
- 5** After completing the tire inflation pressure measurement and adjustment, apply soapy water to the valve and check for leakage.
- 6** Put the tire valve cap back on.

**■ Tire inflation pressure check interval**

You should check tire inflation pressure every two weeks, or at least once a month. Do not forget to check the spare.

**■ Effects of incorrect tire inflation pressure**

Driving with incorrect tire inflation pressure may result in the following:

- Reduced fuel economy
- Reduced driving comfort and poor handling
- Reduced tire life due to wear
- Reduced safety
- Damage to the drive train

If a tire needs frequent inflating, have it checked by your Toyota dealer.

**■ Instructions for checking tire inflation pressure**

When checking tire inflation pres-

sure, observe the following:

- Check only when the tires are cold.  
If your vehicle has been parked for at least 3 hours or has not been driven for more than 1 mile or 1.5 km, you will get an accurate cold tire inflation pressure reading.
- Always use a tire pressure gauge. It is difficult to judge if a tire is properly inflated based only on its appearance.
- It is normal for the tire inflation pressure to be higher after driving as heat is generated in the tire. Do not reduce tire inflation pressure after driving.
- Never exceed the vehicle capacity weight.  
Passengers and luggage weight should be placed so that the vehicle is balanced.



**NOTICE**

■ **When inspecting and adjusting tire inflation pressure**

Be sure to put the tire valve caps back on.

If a valve cap is not installed, dirt or moisture may get into the valve and cause an air leak, resulting in decreased tire inflation pressure.



**WARNING**

■ **Proper inflation is critical to save tire performance**

Keep your tires properly inflated. If the tires are not properly inflated, the following conditions may occur which could lead to an accident resulting in death or serious injury:

- Excessive wear
- Uneven wear
- Poor handling
- Possibility of blowouts resulting from overheated tires
- Air leaking from between tire and wheel
- Wheel deformation and/or tire damage
- Greater possibility of tire damage while driving (due to road hazards, expansion joints, sharp edges in the road, etc.)



**Wheels**

**If a wheel is bent, cracked or heavily corroded, it should be replaced. Otherwise, the tire may separate from the wheel or cause a loss of handling control.**

**Wheel selection**

When replacing wheels, care should be taken to ensure that they are equivalent to those removed in load capacity, diameter, rim width and inset\*.

Replacement wheels are available at your Toyota dealer.

\*: Conventionally referred to as offset.

Toyota does not recommend using the following:

- Wheels of different sizes or types
- Used wheels
- Bent wheels that have been straightened

**When replacing wheels**

The wheels of your vehicle are equipped with tire pressure warning valves and transmitters that allow the tire pressure warning system to provide advance warning in the event of a loss in tire inflation pressure. Whenever wheels are replaced, tire pressure warning valves and transmitters must be installed. (→P.416)

**⚠ WARNING**

**When replacing wheels**

- Do not use wheels that are a different size from those recommended in the Owner's Manual, as this may result in a loss of handling control.
- Never use an inner tube in a leaking wheel which is designed for a tubeless tire. Doing so may result in an accident, causing death or serious injury.

**When installing the wheel nuts**

Never use oil or grease on the wheel bolts or wheel nuts. Oil and grease may cause the wheel nuts to be excessively tightened, leading to bolt or disc wheel damage. In addition, the oil or grease can cause the wheel nuts to loosen and the wheel may fall off, causing an accident and resulting in death or serious injury. Remove any oil or grease from the wheel bolts or wheel nuts.

**Use of defective wheels prohibited**

Do not use cracked or deformed wheels. Doing so could cause the tire to leak air during driving, possibly causing an accident.

**⚠ NOTICE**

**Replacing tire pressure warning valves and transmitters**

- Because tire repair or replacement may affect the tire pressure warning valves and transmitters, make sure to have tires serviced by your Toyota dealer or other qualified service shop. In addition, make sure to purchase your tire pressure warning valves and transmitters at your Toyota dealer.

 NOTICE

- Ensure that only genuine Toyota wheels are used on your vehicle. Tire pressure warning valves and transmitters may not work properly with non-genuine wheels.

**Aluminum wheel precautions**

- Use only Toyota wheel nuts and wrenches designed for use with your aluminum wheels.
- When rotating, repairing or changing your tires, check that the wheel nuts are still tight after driving 1000 miles (1600 km).
- Be careful not to damage the aluminum wheels when using tire chains.
- Use only Toyota genuine balance weights or equivalent and a plastic or rubber hammer when balancing your wheels.

**Air conditioning filter**

The air conditioning filter must be changed regularly to maintain air conditioning efficiency.

**Removing the air conditioning filter**

- 1 Turn the engine switch off.
- 2 Open the glove box. Slide off the damper.

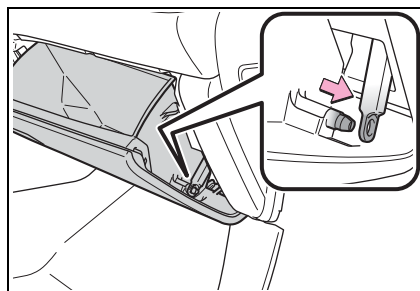

- 3 Push in the glove box on the vehicle's outer side to disconnect the claws. Then pull out the glove box and disconnect the lower claws.

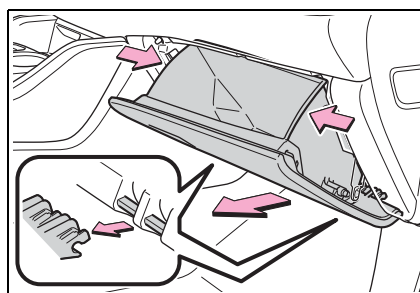

- 4 Unlock the filter cover (A), pull the filter cover out of the

claws (B), and remove the filter cover.

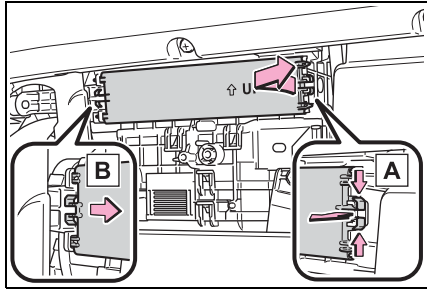

**5** Remove the filter case.

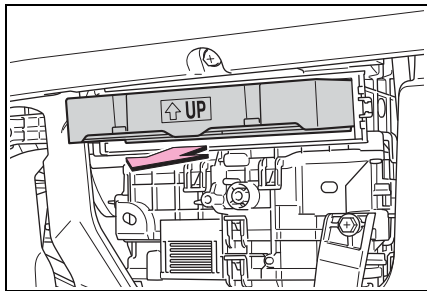

**6** Remove the air conditioning filter from the filter case and replace it with a new one.

The “↑ UP” marks shown on the filter and the filter case should be pointing up.

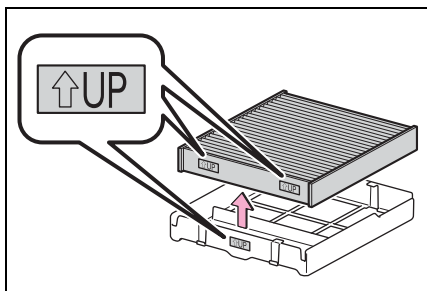

■ **Checking interval**

Inspect and replace the air conditioning filter according to the maintenance schedule. In dusty areas or areas with heavy traffic flow, early

replacement may be required. (For scheduled maintenance information, please refer to the “Owner’s Manual Supplement” or “Scheduled Maintenance Guide”.)

■ **If air flow from the vents decreases dramatically**

The filter may be clogged. Check the filter and replace if necessary.

 **NOTICE**

■ **When using the air conditioning system**

Make sure that a filter is always installed. Using the air conditioning system without a filter may cause damage to the system.

### Electronic key battery

Replace the battery with a new one if it is depleted.

#### ■ If the electronic key battery is depleted

The following symptoms may occur:

- The smart key system and wireless remote control will not function properly.
- The operational range will be reduced.

#### You will need the following items:

- Flathead screwdriver
- Small flathead screwdriver
- Lithium battery CR2032

#### ■ Use a CR2032 lithium battery

- Batteries can be purchased at your Toyota dealer, local electrical appliance shops or camera stores.
- Replace only with the same or equivalent type recommended by the manufacturer.
- Dispose of used batteries according to the local laws.

### Replacing the battery

- 1 Release the lock and remove the mechanical key.

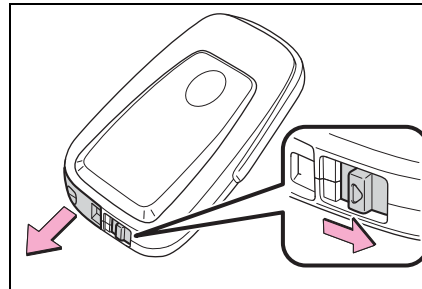

- 2 Remove the key cover.

To prevent damage to the key, cover the tip of the flathead screwdriver with a rag.

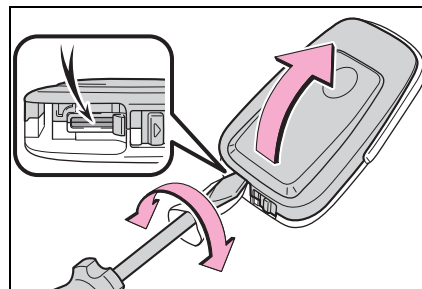

- 3 Remove the depleted battery.

When removing the cover, the electronic key module may stick to the cover and the battery may not be visible. In this case, remove the electronic key module in order to remove the battery.

When removing the battery, use a screwdriver of an appropriate size. Insert a new battery with the “+” ter-

terminal facing up.

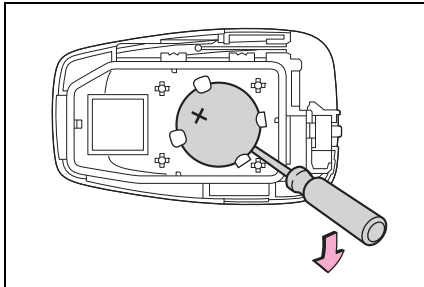

**⚠ WARNING**

■ **Removed battery and other parts**

These parts are small and if swallowed by a child, they can cause choking. Keep away from children. Failure to do so could result in death or serious injury.

**⚠ NOTICE**

■ **For normal operation after replacing the battery**

Observe the following precautions to prevent accidents:

- Always work with dry hands. Moisture may cause the battery to rust.
- Do not touch or move any other component inside the remote control.
- Do not bend either of the battery terminals.

**Checking and replacing fuses**

If any of the electrical components do not operate, a fuse may have blown. If this happens, check and replace the fuses as necessary.

**Checking and replacing fuses**

- 1 Turn the engine switch off.
- 2 Open the fuse box cover.
  - ▶ Engine compartment: type A fuse box

Push the tab in and lift the lid off.

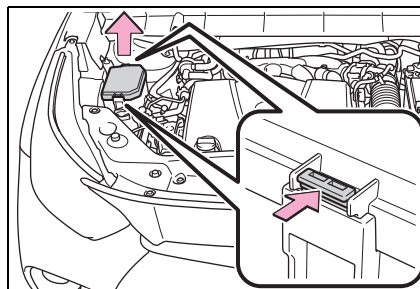

- ▶ Engine compartment: type B fuse box

Push the tab in and lift the lid off.

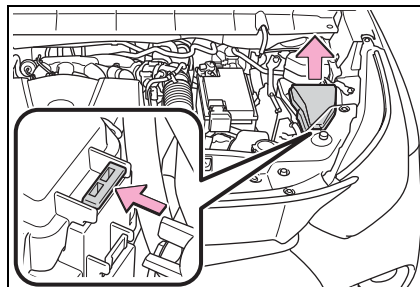

**430** 6-3. Do-it-yourself maintenance

- ▶ Under the driver's side instrument panel

Remove the lid.

Make sure to push the claw when removing/installing the lid.

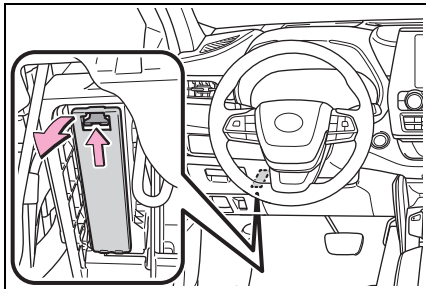

**3** Remove the fuse.

Only type B fuse can be removed using the pullout tool.

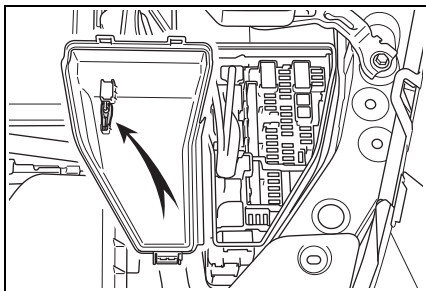

**4** Check if the fuse is blown.

Replace the blown fuse with a new fuse of an appropriate amperage rating. The amperage rating can be found on the fuse box lid.

- ▶ Type A

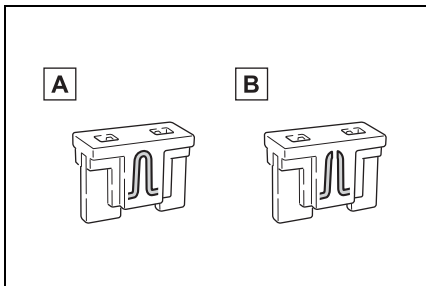

**A** Normal fuse

**B** Blown fuse

- ▶ Type B

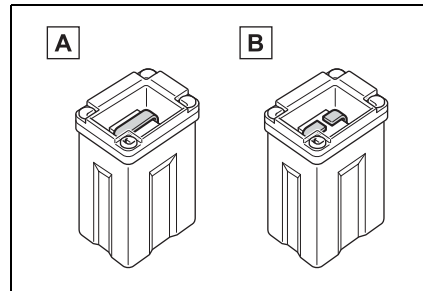

**A** Normal fuse

**B** Blown fuse

- ▶ Type C

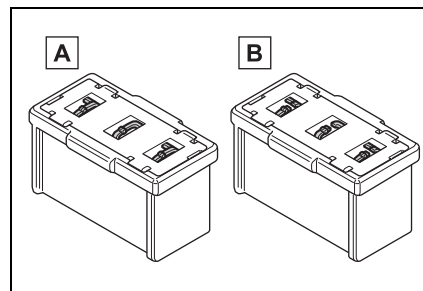

**A** Normal fuse

**B** Blown fuse

■ **After a fuse is replaced**

- If the lights do not turn on even after the fuse has been replaced, a bulb may need replacement. (→P.432)
- If the replaced fuse blows again, have the vehicle inspected by your Toyota dealer.

■ **If there is an overload in a circuit**

The fuses are designed to blow, protecting the wiring harness from damage.

**■ When replacing light bulbs**

Toyota recommends that you use genuine Toyota products designed for this vehicle. Because certain bulbs are connected to circuits designed to prevent overload, non-genuine parts or parts not designed for this vehicle may be unusable.

**⚠ WARNING****■ To prevent system breakdowns and vehicle fire**

Observe the following precautions.

Failure to do so may cause damage to the vehicle, and possibly a fire or injury.

- Never use a fuse of a higher amperage rating than that indicated, or use any other object in place of a fuse.
- Always use a genuine Toyota fuse or equivalent. Never replace a fuse with a wire, even as a temporary fix.
- Do not modify the fuses or fuse boxes.

**⚠ NOTICE****■ Before replacing fuses**

Have the cause of electrical overload determined and repaired by your Toyota dealer as soon as possible.

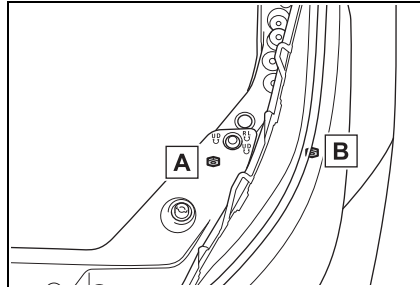
**Headlight aim****Vertical movement adjusting bolts**

**A** Adjustment bolt A

**B** Adjustment bolt B

**Before checking the headlight aim**

- Make sure the vehicle has a full tank of gasoline and the area around the headlight is not deformed.
- Park the vehicle on level ground.
- Make sure the tire inflation pressure is at the specified level.
- Have someone sit in the driver's seat.
- Bounce the vehicle several times.

### Adjusting the headlight aim

- 1 Using a Phillips-head screwdriver, turn bolt A in either direction.

Remember the turning direction and the number of turns.

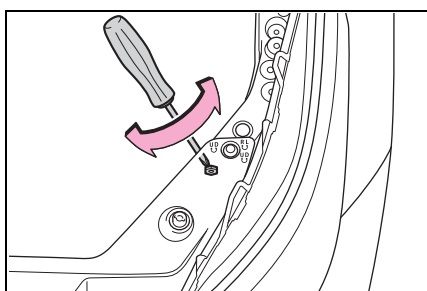

- 2 Turn bolt B the same number of turns and in the same direction as step 1.

If the headlight cannot be adjusted using this procedure, take the vehicle to your Toyota dealer to adjust the headlight aim.

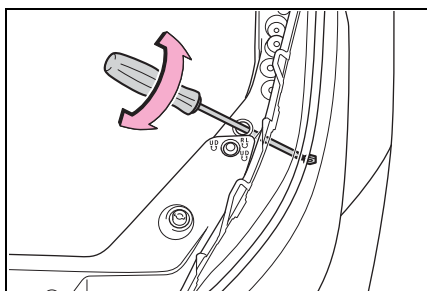

### Light bulbs

You may replace the following bulbs by yourself. The difficulty level of replacement varies depending on the bulb. If necessary bulb replacement seems difficult to perform, contact your Toyota dealer.

For more information about replacing other light bulbs, contact your Toyota dealer.

### Preparing for light bulb replacement

Check the wattage of the light bulb to be replaced. (→P.501)

### Turning off the power back door main switch (if equipped)

→P.520

### Bulb locations

- ▶ Front (type A)

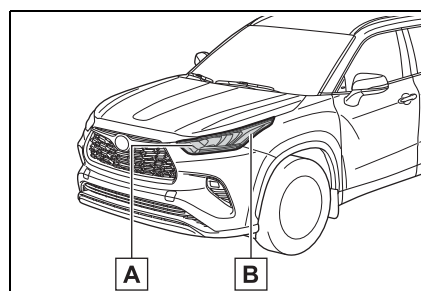

- A** Front turn signal lights/park-



ing lights

**B** Front side marker lights

► Front (type B)

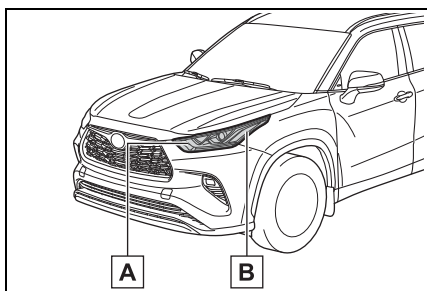

**A** Front turn signal lights

**B** Front side marker lights

► Rear

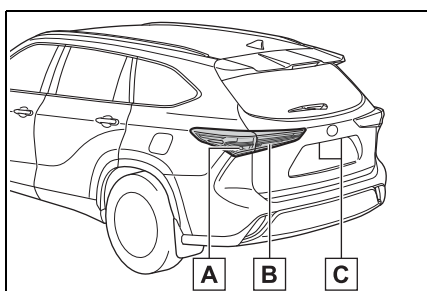

**A** Rear turn signal lights

**B** Back-up lights

**C** License plate lights

■ **Lights that need to be replaced by your Toyota dealer**

- Headlight low beams
- Headlight high beams
- Parking lights (type B)
- Daytime running lights (type A)
- Daytime running lights/parking lights (type B)

- Front fog lights
- Side turn signal lights
- Tail lights/stop lights
- Rear side marker lights
- Tail lights
- High mounted stoplight
- Outer foot lights (if equipped)

■ **LED lights**

The lights other than the following lights each consist of a number of LEDs. If any of the LEDs burn out, take your vehicle to your Toyota dealer to have the light replaced.

- Front turn signal lights/parking lights (type A)
- Front turn signal lights (type B)
- Front side marker lights
- Rear turn signal lights
- Back-up lights
- License plate lights

■ **Condensation build-up on the inside of the lens**

Temporary condensation build-up on the inside of the light lens does not indicate a malfunction. Contact your Toyota dealer for more information in the following situations:

- Large drops of water have built up on the inside of the lens.
- Water has built up inside the light.

■ **When replacing light bulbs**

→P.431

**Replacing light bulbs**

■ **Front turn signal lights/parking lights (type A) and front turn signal lights (type B)**

- 1 Turn the bulb base counter-clockwise and remove it.

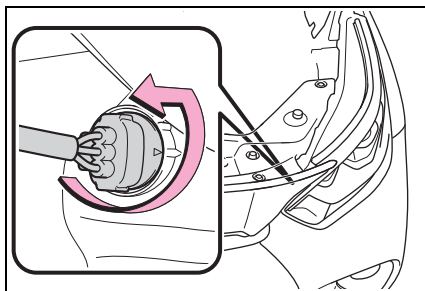

- 2 Remove the light bulb.

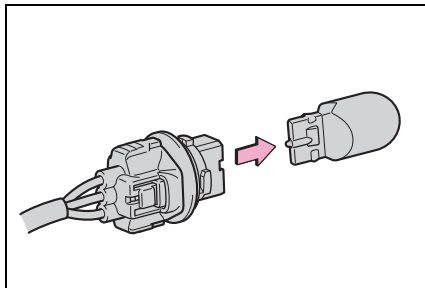

- 3 Install a new light bulb, and then install the bulb base to the light unit by inserting it and turning the bulb base clockwise.

After installing the bulb base, wiggle it lightly to make sure it is securely installed and turn the lights and turn signal lights on to visually check that there is no light leaking from between the bulb base and

light unit.

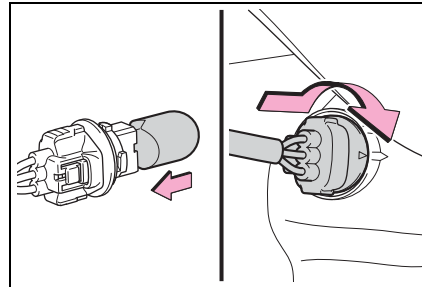

■ **Front side marker lights**

- 1 Turn the bulb base counter-clockwise and remove it.

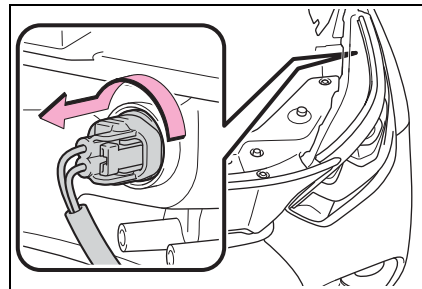

- 2 Remove the light bulb.

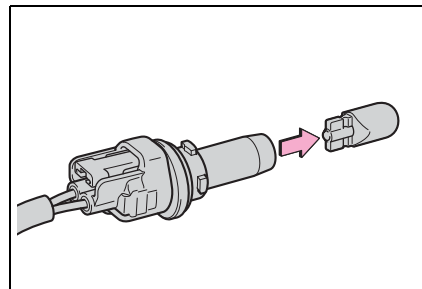

- 3 Install a new light bulb, and then install the bulb base to the light unit by inserting it and turning the bulb base clockwise.

After installing the bulb base, wiggle it lightly to make sure it is securely installed and turn the lights on to visually check that there is no light leaking from between the bulb

base and light unit.

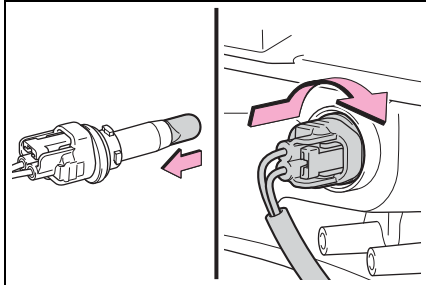

■ **Rear turn signal lights**

- 1 Open the back door and using a flathead screwdriver, remove the cover.

To prevent damage to the vehicle, wrap the tip of the flathead screwdriver with tape, etc.

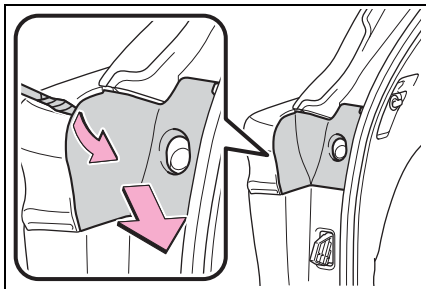

- 2 Remove the securing 2 screws and light unit.

Remove the light unit by pulling it straight back from the rear of the vehicle.

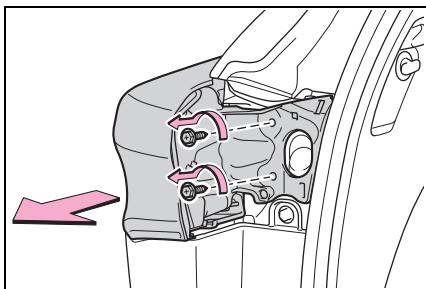

- 3 Disconnect the wire harness.

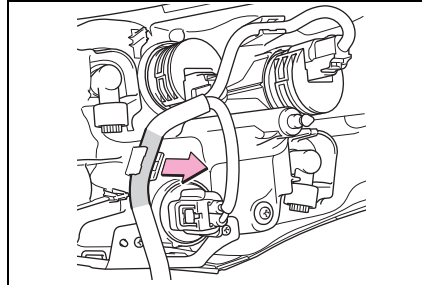

- 4 Turn the bulb base counter-clockwise and remove it.

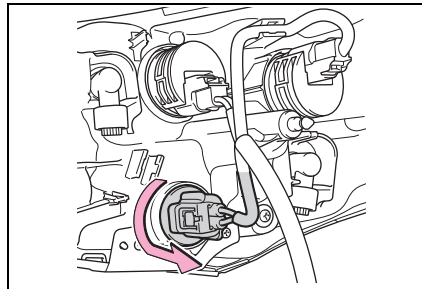

- 5 Remove the light bulb.

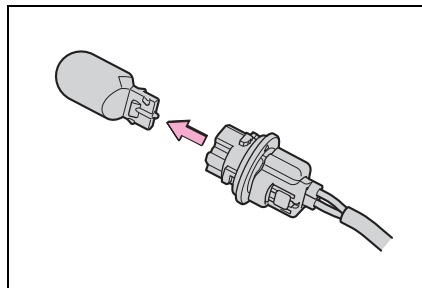

- 6 Install a new light bulb, and then install the bulb base to the light unit by inserting it and turning it clockwise.

After installing the bulb base, wiggle it lightly to make sure it is securely installed and turn on the turn signal lights to visually check that there is no light leaking from between the bulb base and light

unit.

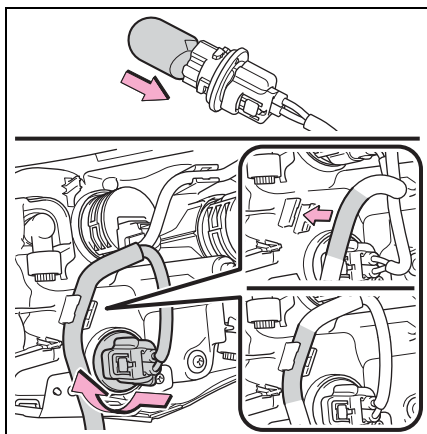

**7** Install the light unit.

Align the 2 guides and push the light unit toward the front of the vehicle to install it.

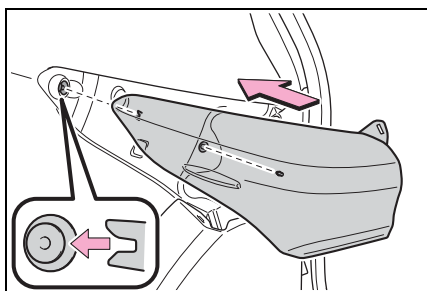

**8** Install the 2 screws.

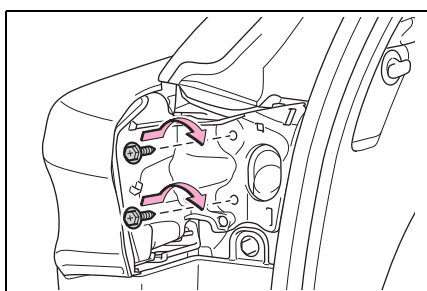

**9** Install the cover.

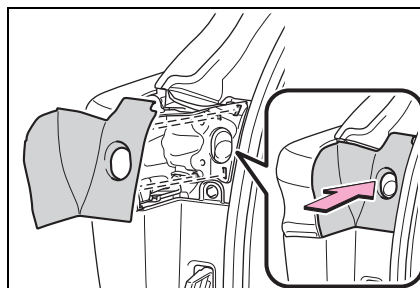

■ **Back-up lights**

**1** Open the back door and remove the cover.

Using a flathead screwdriver, remove the cover.

To prevent damage to the vehicle, wrap the tip of the flathead screwdriver with tape, etc.

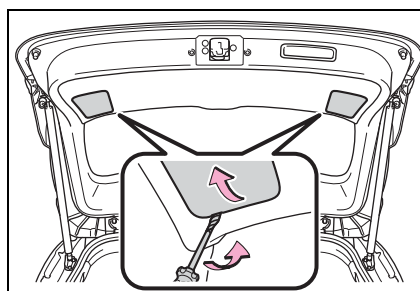

**2** Turn the bulb base counter-clockwise and remove it.

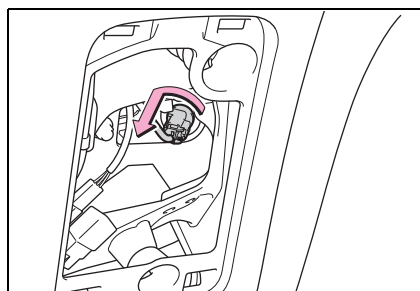

**3** Remove the light bulb.

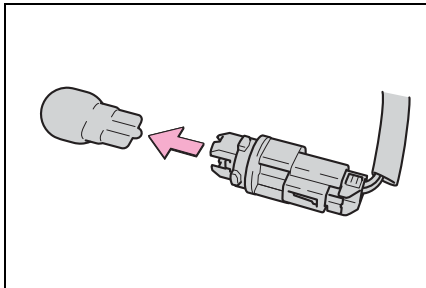

**4** Install a new light bulb, and then install the bulb base to the light unit by inserting it and turning it clockwise.

After installing the bulb base, wiggle it lightly to make sure it is securely installed and turn on the back-up lights to visually check that there is no light leaking from between the bulb base and light unit.

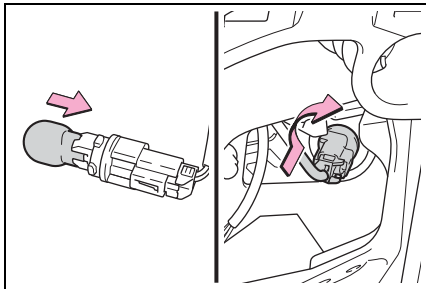

**5** Install the cover.

Align the tabs of the cover with the grooves and install the cover.

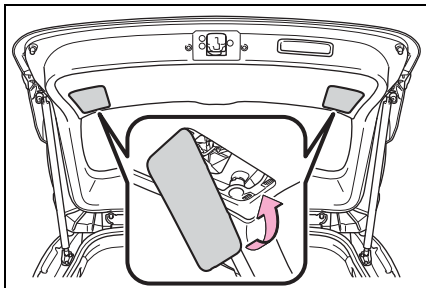

■ **License plate lights**

**1** Remove the cover.

Using a flathead screwdriver, remove the cover.

To prevent damage to the vehicle, wrap the tip of the flathead screwdriver with tape, etc.

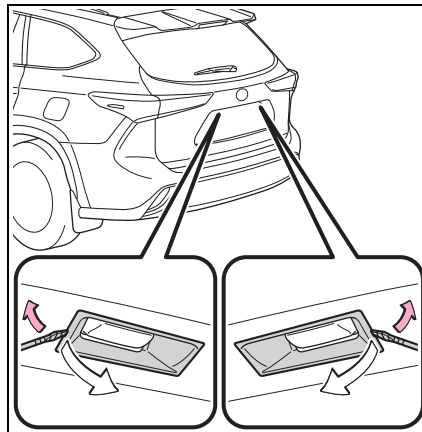

**2** Remove the lens.

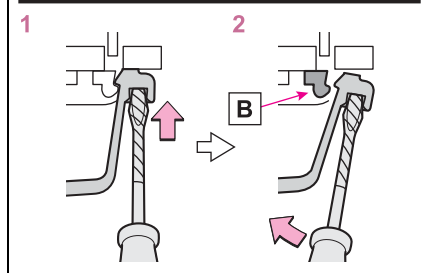
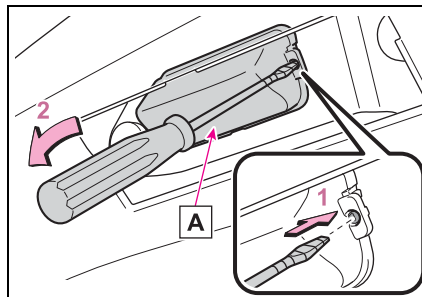

**A** Lens

**B** Hook

- 1** Insert a small flathead screwdriver, etc. into either the right or left hole of the lens.
- 2** Push the screwdriver sideways in the direction of the arrow shown in the illustration, disengage the hook, and then remove the lens.

To prevent damage to the vehicle, wrap the tip of the screwdriver with tape, etc.

- 3** Remove the light bulb.

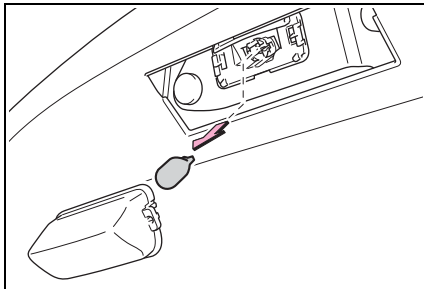

- 4** Install a new light bulb.

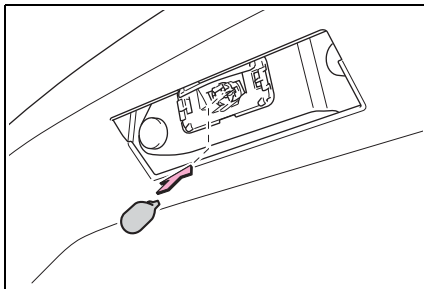

- 5** Install the lens.

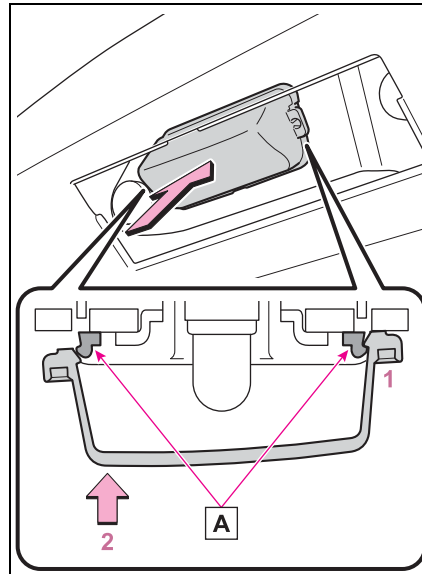

**A** Hooks

- 1** Fit the lens into either the right or left hooks.
- 2** Push the lens into place.

After installation, confirm that the lens is properly installed by gently pulling it.

- 6** Install the cover.

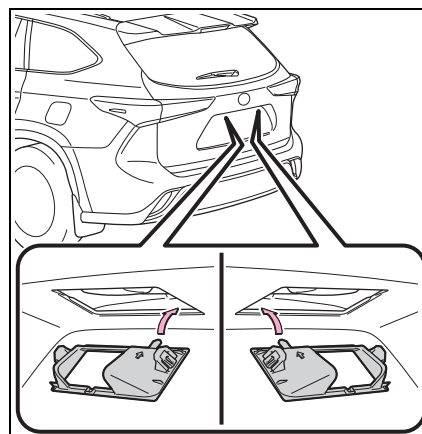

 **WARNING****■ To prevent injury**

Before performing any light bulb replacement procedure, be sure to turn the engine switch off. Failure to do so may result in burns from hot components or a part of your body may get caught on an operating component, possibly causing serious injury.

**■ Replacing light bulbs**

- Turn off the lights. Do not attempt to replace the bulb immediately after turning off the lights. The bulbs become very hot and may cause burns.
- Do not touch the glass portion of the light bulb with bare hands. When it is unavoidable to hold the glass portion, use and hold with a clean dry cloth to avoid getting moisture and oils on the bulb. Also, if the bulb is scratched or dropped, it may blow out or crack.
- Fully install light bulbs and any parts used to secure them. Failure to do so may result in heat damage, fire, or water entering the light unit. This may damage the lights or cause condensation to build up on the lens.
- Do not attempt to repair or disassemble light bulbs, connectors, electric circuits or component parts. Doing so may result in death or serious injury due to electric shock.

**■ To prevent damage or fire**

- Make sure bulbs are fully seated and locked.
- Check the wattage of the bulb before installing to prevent heat damage.





**When trouble arises****7****7-1. Essential information**Emergency flashers .... **442**If your vehicle has to be  
stopped in an emergency  
..... **442**If the vehicle is trapped in  
rising water..... **443****7-2. Steps to take in an emergency**If your vehicle needs to be  
towed..... **445**If you think something is  
wrong ..... **448**Fuel pump shut off system  
..... **449**If a warning light turns on or  
a warning buzzer sounds  
..... **450**If a warning message is displayed..... **460**If you have a flat tire.... **464**If the engine will not start  
..... **478**If you lose your keys ... **479**If the fuel filler door cannot  
be opened ..... **480**If the electronic key does  
not operate properly .. **481**If the vehicle battery is discharged ..... **483**If your vehicle overheats  
..... **487**If the vehicle becomes stuck  
..... **489**

### Emergency flashers

The emergency flashers are used to warn other drivers when the vehicle has to be stopped on the road due to a breakdown, etc.

### Operating instructions

Press the switch.

All the turn signal lights will flash. To turn them off, press the switch once again.

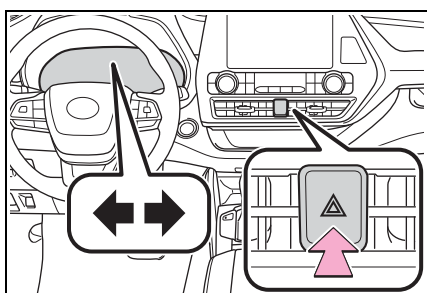

### Emergency flashers

- If the emergency flashers are used for a long time while the engine is not operating, the battery may discharge.
- If any of the SRS airbags deploy (inflate) or in the event of a strong rear impact, the emergency flashers will turn on automatically. The emergency flashers will turn off automatically after operating for approximately 20 minutes. To manually turn the emergency flashers off, press the switch twice.  
(The emergency flashers may not turn on automatically depending on the force of the impact and conditions of the collision.)

### If your vehicle has to be stopped in an emergency

Only in an emergency, such as if it becomes impossible to stop the vehicle in the normal way, stop the vehicle using the following procedure:

### Stopping the vehicle

- 1 Steadily step on the brake pedal with both feet and firmly depress it.

Do not pump the brake pedal repeatedly as this will increase the effort required to slow the vehicle.

- 2 Shift the shift lever to N.
  - ▶ If the shift lever is shifted to N
- 3 After slowing down, stop the vehicle in a safe place by the road.
- 4 Stop the engine.
  - ▶ If the shift lever cannot be shifted to N
- 3 Keep depressing the brake pedal with both feet to reduce vehicle speed as much as possible.
- 4 To stop the engine, press and hold the engine switch for 2 consecutive seconds or

more, or press it briefly 3 times or more in succession.

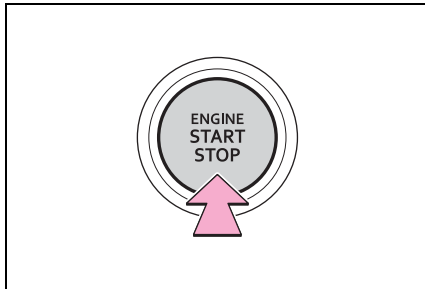

- 5** Stop the vehicle in a safe place by the road.

**⚠ WARNING**

**■ If the engine has to be turned off while driving**

Power assist for the brakes and steering wheel will be lost, making the brake pedal harder to depress and the steering wheel heavier to turn. Decelerate as much as possible before turning off the engine.

**If the vehicle is trapped in rising water**

**In the event the vehicle is submerged in water, remain calm and perform the following.**

- Remove the seat belt first.
- If the door can be opened, open the door and exit the vehicle.
- If the door can not be opened, open the window using the power window switch and exit the vehicle through the window.
- If the window can not be opened using the power window switch, remain calm, wait until the water level inside the vehicle rises to the point that the water pressure inside of the vehicle equals the water pressure outside of the vehicle, and then open the door and exit the vehicle.



**WARNING**

■ **Using an emergency hammer\* for emergency escape**

The front side windows and rear side windows, as well as the rear window can be shattered with an emergency hammer\* used for emergency escape.

However, an emergency hammer\* can not shatter the windshield as it is laminated glass.

\*: Contact your Toyota dealer or aftermarket accessory manufacturer for further information about an emergency hammer.

■ **Escaping the vehicle from the window**

There are cases where escaping the vehicle from the window is not possible due to seating position, passenger body type, etc.

When using an emergency hammer, consider your seat location and the size of the window opening to ensure that the opening is accessible and large enough to escape.

**If your vehicle needs to be towed**

**If towing is necessary, we recommend having your vehicle towed by your Toyota dealer or commercial towing service, using a wheel-lift type truck or flatbed truck.**

**Use a safety chain system for all towing, and abide by all state/provincial and local laws.**

**If towing your vehicle with a wheel-lift type truck from the front, the vehicle's rear wheels and axles must be in good conditions. (→P.447)**

**If they are damaged, use a towing dolly or flatbed truck.**

**⚠ WARNING**

Observe the following precautions. Failure to do so may result in death or serious injury.

**■ When towing the vehicle**

▶ 2WD models

Be sure to transport the vehicle with the front wheels raised or with all four wheels raised off the ground. If the vehicle is towed with the front wheels contacting the ground, the drivetrain and related parts may be damaged.

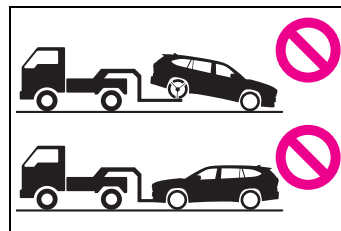

▶ AWD models

Be sure to transport the vehicle with all four wheels raised off the ground. If the vehicle is towed with the tires contacting the ground, the drivetrain or related parts may be damaged, the vehicle may fly off the truck.

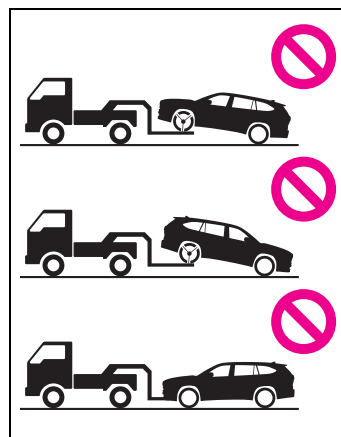

**⚠ WARNING**

■ **While towing**

- When towing using cables or chains, avoid sudden starts, etc. which place excessive stress on the towing eyelets, cables or chains. The towing eyelets, cables or chains may become damaged, broken debris may hit people, and cause serious damage.
- Do not turn the engine switch off. There is a possibility that the steering wheel is locked and cannot be operated.

**⚠ NOTICE**

■ **To prevent damage to the vehicle when towing using a wheel-lift type truck**

- Do not tow the vehicle from the rear when the engine switch is off. The steering lock mechanism is not strong enough to hold the front wheels straight.
- When raising the vehicle, ensure adequate ground clearance for towing at the opposite end of the raised vehicle. Without adequate clearance, the vehicle could be damaged while being towed.

■ **To prevent damage to the vehicle when towing with a sling-type truck**

Do not tow with a sling-type truck, either from the front or rear.

■ **To prevent damage to the vehicle during emergency towing**

Do not secure cables or chains to the suspension components.

■ **When towing a vehicle equipped with a Stop & Start system (if equipped)**

If it is necessary to tow the vehicle with all 4 wheels on the ground, perform the following procedure before towing the vehicle, in order to protect the system. Turn the engine switch off and then start the engine or turn the engine switch to ON.

■ **Recreational towing (behind motor home, etc.)**

Never dinghy tow your vehicle to prevent causing serious damage to the Dynamic Torque Control AWD system (AWD models) or Dynamic Torque Vectoring AWD system (AWD models) and transmission. (→P.199)

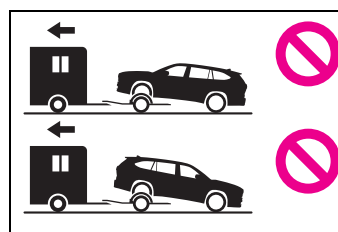

**Situations when it is necessary to contact dealers before towing**

The following may indicate a problem with your transmission. Contact your Toyota dealer or commercial towing service before towing.

- The engine is running but the vehicle does not move.
- The vehicle makes an abnormal sound.

**Towing with a wheel-lift type truck**

- ▶ From the front (2WD models)

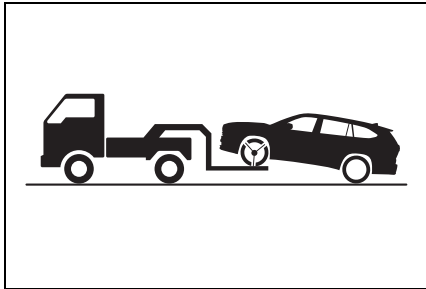

Release the parking brake.  
Turn automatic mode off.P.210

- ▶ From the front (AWD models)

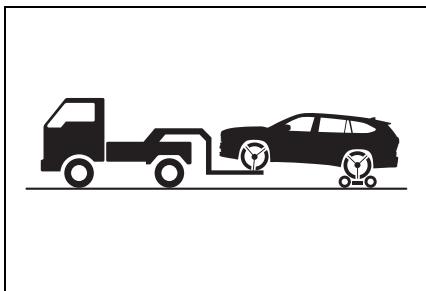

Use a towing dolly under the rear wheels.

- ▶ From the rear

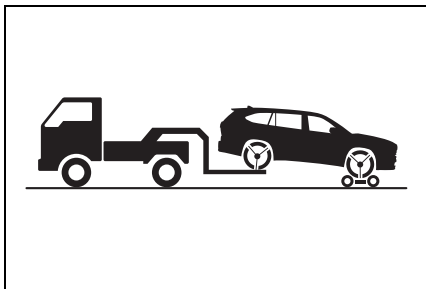

Use a towing dolly under the front wheels.

NOTICE

■ **Towing with a sling-type truck**

Do not tow with a sling-type truck to prevent body damage.

- ▶ 2WD models

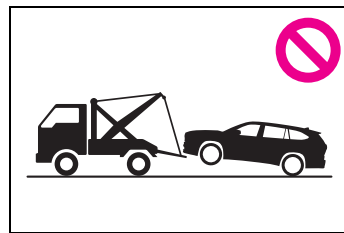

- ▶ AWD models

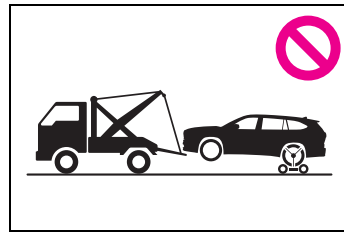

**Using a flatbed truck**

If your vehicle is transported by a flatbed truck, it should be tied down at the locations shown in the illustration.

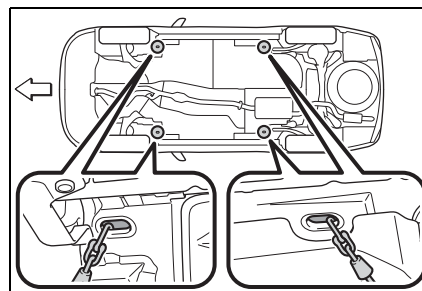

If you use chains or cables to tie down your vehicle, the angles shaded in black must be 45°.

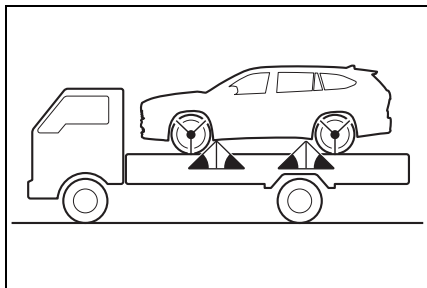

**NOTICE**

**■ Using a flatbed truck**

Do not overly tighten the tie downs or the vehicle may be damaged.

**Emergency towing**

A driver must be in the vehicle to steer and operate the brakes. The vehicle's wheels, drive train, axles, steering and brakes must be in good condition.

**If you think something is wrong**

If you notice any of the following symptoms, your vehicle probably needs adjustment or repair. Contact your Toyota dealer as soon as possible.

**Visible symptoms**

- Fluid leaks under the vehicle (Water dripping from the air conditioning after use is normal.)
- Flat-looking tires or uneven tire wear
- Engine coolant temperature gauge needle continually points higher than normal

**Audible symptoms**

- Changes in exhaust sound
- Excessive tire squeal when cornering
- Strange noises related to the suspension system
- Pinging or other noises related to the engine

**Operational symptoms**

- Engine missing, stumbling or running roughly
- Appreciable loss of power
- Vehicle pulls heavily to one



side when braking

- Vehicle pulls heavily to one side when driving on a level road
- Loss of brake effectiveness, spongy feeling, pedal almost touches the floor

**Fuel pump shut off system**

**To minimize the risk of fuel leakage when the engine stalls or when an airbag inflates upon collision, the fuel pump shut off system stops the supply of fuel to the engine.**

**Restarting the engine**

Follow the procedure below to restart the engine after the system is activated.

- 1** Turn the engine switch to ACC or turn it OFF.
- 2** Restart the engine.



**NOTICE**

**■ Before starting the engine**

Inspect the ground under the vehicle.  
If you find that fuel has leaked onto the ground, the fuel system has been damaged and is in need of repair. Do not restart the engine.

**If a warning light turns on or a warning buzzer sounds**

Calmly perform the following actions if any of the warning lights comes on or flashes. If a light comes on or flashes, but then goes off, this does not necessarily indicate a malfunction in the system. However, if this continues to occur, have the vehicle inspected by your Toyota dealer.

**Actions to the warning lights or warning buzzers**

■ Brake system warning light

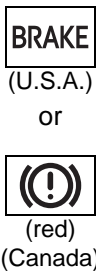
Warning light	Details/Actions
 <p><b>BRAKE</b> (U.S.A.) or (red) (Canada)</p>	<p>Indicates that:</p> <ul style="list-style-type: none"> <li>● The brake fluid level is low; or</li> <li>● The brake system is malfunctioning</li> </ul> <p>→ <b>Immediately stop the vehicle in a safe place and contact your Toyota dealer. Continuing to drive the vehicle may be dangerous.</b></p>

■ Brake system warning light

Warning light	Details/Actions
 <p>(red)</p>	<p>Indicates a malfunction in the electric parking brake</p> <p>→ <b>Have the vehicle inspected by your Toyota dealer immediately.</b></p>

■ High coolant temperature warning light\* (warning buzzer)

Warning light	Details/Actions
	<p>Indicates that the engine coolant temperature is too high</p> <p>→ <b>Immediately stop the vehicle in a safe place. Handling method (→P.487)</b></p>

\*: This light illuminates on the multi-information display.

■ **Charging system warning light**



Warning light	Details/Actions
	Indicates a malfunction in the vehicle's charging system → <b>Immediately stop the vehicle in a safe place and contact your Toyota dealer.</b>

■ **Low engine oil pressure warning light\* (warning buzzer)**

Warning light	Details/Actions
	Indicates that the engine oil pressure is too low → <b>Immediately stop the vehicle in a safe place and contact your Toyota dealer.</b>

\*: This light illuminates on the multi-information display.

■ **Malfunction indicator lamp**



Warning light	Details/Actions
 (U.S.A.) or  (Canada)	Indicates a malfunction in: <ul style="list-style-type: none"> <li>● The electronic engine control system;</li> <li>● The electronic throttle control system; or</li> <li>● The electronic automatic transmission control system</li> </ul> → <b>Immediately stop the vehicle in a safe place and contact your Toyota dealer.</b>

■ **SRS warning light**

Warning light	Details/Actions
	Indicates a malfunction in: <ul style="list-style-type: none"> <li>● The SRS airbag system;</li> <li>● The front passenger occupant classification system; or</li> <li>● The seat belt pretensioner system</li> </ul> → <b>Have the vehicle inspected by your Toyota dealer immediately.</b>

## 452 7-2. Steps to take in an emergency

### ■ ABS warning light

Warning light	Details/Actions
 <p>(U.S.A.) or</p>  <p>(Canada)</p>	<p>Indicates a malfunction in:</p> <ul style="list-style-type: none"> <li>● The ABS; or</li> <li>● The brake assist system</li> </ul> <p>→ <b>Have the vehicle inspected by your Toyota dealer immediately.</b></p>

### ■ Brake Override System warning light/Drive-Start Control warning light\* (warning buzzer)

Warning light	Details/Actions
	<p>When a buzzer sounds:</p> <ul style="list-style-type: none"> <li>● Brake Override System is malfunctioning;</li> <li>● Drive-Start Control is operating;</li> <li>● Drive-Start Control is malfunctioning; or</li> <li>● Parking Support Brake function (for static objects) (if equipped) is operating</li> </ul> <p>→ <b>Follow the instructions displayed on the multi-information display.</b></p> <p>When a buzzer does not sound: Brake Override System is operating</p> <p>→ <b>Release the accelerator pedal and depress the brake pedal.</b></p>

\*: This light illuminates on the multi-information display.

### ■ Electric power steering system warning light (warning buzzer)

Warning light	Details/Actions
 <p>(red/yellow)</p>	<p>Indicates a malfunction in the EPS (Electric Power Steering) system</p> <p>→ <b>Have the vehicle inspected by your Toyota dealer immediately.</b></p>

### ■ Low fuel level warning light

Warning light	Details/Actions
	Indicates that remaining fuel is approximately 2.7 gal. (10.2 L, 2.2 Imp. gal.) or less → <b>Refuel the vehicle.</b>

### ■ Driver's and front passenger's seat belt reminder light (warning buzzer)\*

Warning light	Details/Actions
	Warns the driver and/or front passenger to fasten their seat belts → <b>Fasten the seat belt.</b> <b>If the front passenger's seat is occupied, the front passenger's seat belt also needs to be fastened to make the warning light (warning buzzer) turn off.</b>

\*: Driver's seat belt warning buzzer:

The driver's seat belt warning buzzer sounds to alert the driver that his or her seat belt is not fastened. Once the engine switch is turned to ON, the buzzer sounds. If the seat belt is still unfastened, the buzzer sounds intermittently for a certain period of time after the vehicle reaches a certain speed.

Front passenger's seat belt warning buzzer:

The front passenger's seat belt warning buzzer sounds to alert the front passenger that his or her seat belt is not fastened. If the seat belt is unfastened, the buzzer sounds intermittently for a certain period of time after the vehicle reaches a certain speed.

### ■ Rear passengers' seat belt reminder light\*<sup>1</sup> (warning buzzer)\*<sup>2</sup>

Warning light	Details/Actions
	Warns the second and/or third seat passengers to fasten their seat belts. An indicator corresponding to an unfastened second or third seat seat belt will illuminate. → <b>Fasten the seat belt.</b>

\*<sup>1</sup>: This light illuminates on the multi-information display.

\*<sup>2</sup>: Rear passengers' seat belt warning buzzer:

The rear passengers' seat belt warning buzzer sounds to alert the rear passenger that his or her seat belt is not fastened. If the seat belt is unfastened, the buzzer sounds intermittently for a certain period of time, after the

## 454 7-2. Steps to take in an emergency

seat belt is fastened and unfastened and the vehicle reaches a certain speed.

### ■ Tire pressure warning light

Warning light	Details/Actions
	<p>When the light comes on after blinking for approximately 1 minute:            Malfunction in the tire pressure warning system            → <b>Have the system checked by your Toyota dealer.</b></p> <p>When the light comes on:            Low tire inflation pressure such as</p> <ul style="list-style-type: none"> <li>● Natural causes</li> <li>● Flat tire</li> </ul> <p>→ <b>Immediately stop the vehicle in a safe place.</b>  <b>Handling method (→P.458)</b></p>

### ■ LTA indicator\* (warning buzzer)

Warning light	Details/Actions
	<p>Indicates a malfunction in the LTA (Lane Tracing Assist)            → <b>Follow the instructions displayed on the multi-information display. (→P.250)</b></p>

\*: This light illuminates on the multi-information display.

### ■ Stop & Start cancel indicator\*

Warning light	Details/Actions
	<p>Indicates a malfunction in the Stop &amp; Start system            (The Stop &amp; Start cancel indicator will come on when the system is canceled: →P.265)            → <b>Have the vehicle inspected by your Toyota dealer immediately.</b></p>

\*: This light illuminates on the multi-information display.

■ **Intuitive parking assist OFF indicator (warning buzzer)**

Warning light	Details/Actions
 <p>(flashes) (if equipped)</p>	<p>Indicates a malfunction in the intuitive parking assist function</p> <p>→ <b>Have the vehicle inspected by your Toyota dealer immediately.</b></p> <p>Indicates that the system is temporarily unavailable, possibly due to a sensor being dirty or covered with ice, etc.</p> <p>→ <b>Follow the instructions displayed on the multi-information display. (→P.279)</b></p>

■ **RCTA OFF indicator\* (warning buzzer)**

Warning light	Details/Actions
 <p>(flashes) (if equipped)</p>	<p>When a buzzer sounds:</p> <p>Indicates a malfunction in the RCTA (Rear Cross Traffic Alert) function</p> <p>→ <b>Have the vehicle inspected by your Toyota dealer immediately.</b></p> <p>When a buzzer does not sound:</p> <p>Indicates that the rear bumper around the radar sensor is covered with dirt, etc. (→P.272)</p> <p>→ <b>Follow the instructions displayed on the multi-information display. (→P.285)</b></p>

\*: This light illuminates on the multi-information display.

■ **PKSB OFF indicator (warning buzzer)**

Warning light	Details/Actions
 <p>(flashes) (if equipped)</p>	<p>When a buzzer sounds:</p> <p>Indicates a malfunction in the PKSB (Parking Support Brake) system</p> <p>→ <b>Have the vehicle inspected by your Toyota dealer immediately.</b></p> <p>When a buzzer does not sound:</p> <p>Indicates that the system is temporarily unavailable, possibly due to a sensor being dirty or covered with ice, etc.</p> <p>→ <b>Follow the instructions displayed on the multi-information display. (→P.294, 460)</b></p>

■ **PCS warning light**

Warning light	Details/Actions
 (flashes or illuminates)	<p>When a buzzer sounds simultaneously:                      Indicates a malfunction has occurred in the PCS (Pre-Collision System).                      → <b>Have the vehicle inspected by your Toyota dealer immediately.</b></p> <p>When a buzzer does not sound:                      The PCS (Pre-Collision System) has become temporarily unavailable, corrective action may be necessary.                      → <b>Follow the instructions displayed on the multi-information display. (→P.227, 462)</b></p> <p>If the PCS (Pre-Collision System) or VSC (Vehicle Stability Control) system is disabled, the PCS warning light will illuminate.                      → <b>P.240</b></p>

■ **Slip indicator**

Warning light	Details/Actions
	<p>When the warning light is illuminated:                      Indicates a malfunction in:                      ● The VSC system;                      ● The TRAC system;                      ● The Trailer Sway Control; or                      ● The hill-start assist control system;                      → <b>Have the vehicle inspected by your Toyota dealer immediately.</b></p> <p>When the warning light flashes:                      Indicates that the VSC, TRAC or Trailer Sway Control system is operating</p>

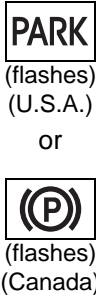

■ **Parking brake indicator (warning buzzer)\***

Warning light	Details/Actions
	<p>It is possible that the parking brake is not fully engaged or released                      → <b>Operate the parking brake switch once again.</b></p> <p>This light comes on when the parking brake is not released. If the light turns off after the parking brake is fully released, the system is operating normally.</p>

\*: A buzzer will sound if the vehicle is driven at a speed of approximately 3 mph (5 km/h) or more.

■ **Brake hold operated indicator**

Warning light	Details/Actions
	<p>Indicates a malfunction in the brake hold system                      → <b>Have the vehicle inspected by your Toyota dealer immediately.</b></p>

■ **Warning buzzer**

In some cases, the buzzer may not be heard due to being in a noisy location or audio sound.

■ **Front passenger detection sensor, seat belt reminder and warning buzzer**

- If luggage is placed on the front passenger seat, the front passenger detection sensor may cause the warning light to flash and the warning buzzer to sound even if a passenger is not sitting in the seat.
- If a cushion is placed on the seat, the sensor may not detect a passenger, and the warning light may not operate properly.

■ **SRS warning light**

This warning light system monitors the airbag sensor assembly, front impact sensors, side impact sensors (front door), side impact sensors

(rear), driver's seat position sensor, driver's seat belt buckle switch, front passenger occupant classification system (ECU and sensors), "PASS AIR BAG ON" indicator light, "PASS AIR BAG OFF" indicator light, front passenger's seat belt buckle switch, driver's seat belt pretensioner, front passenger's seat belt pretensioner and force limiter, airbags, interconnecting wiring and power sources. (→P.32)

■ **If the malfunction indicator lamp comes on while driving**

First check the following:

- Is the fuel tank empty?  
If it is, fill the fuel tank immediately.
- Is the fuel tank cap loose?  
If it is, tighten it securely.

The light will go off after several driving trips.

If the light does not go off even after several trips, contact your Toyota dealer as soon as possible.

■ **Electric power steering system warning light (warning buzzer)**

When the battery charge becomes insufficient or the voltage temporarily drops, the electric power steering system warning light may come on and the warning buzzer may sound.

■ **When the tire pressure warning light comes on**

Inspect the tires to check if a tire is punctured.

If a tire is punctured: →P.464

If none of the tires are punctured: Turn the engine switch off then turn it to ON. Check if the tire pressure warning light comes on or blinks.

- ▶ If the tire pressure warning light blinks for 1 minute then stays on

There may be a malfunction in the tire pressure warning system. Have the vehicle inspected by your Toyota dealer immediately.

- ▶ If the tire pressure warning light comes on
  - 1 After the temperature of the tires has lowered sufficiently, check the inflation pressure of each tire and adjust them to the specified level.
  - 2 If the warning light does not turn off even after several minutes have elapsed, check that the inflation pressure of each tire is at the specified level and perform initialization. (→P.417)

If the warning light does not turn off several minutes after the initialization has been performed, have the vehicle inspected by your Toyota dealer immediately.

■ **The tire pressure warning light may come on due to natural causes**

The tire pressure warning light may come on due to natural causes such as natural air leaks and tire inflation pressure changes caused by temperature. In this case, adjusting the tire inflation pressure will turn off the

warning light (after a few minutes).

■ **When a tire is replaced with a spare tire**

Vehicles with a compact spare tire: The compact spare tire is not equipped with a tire pressure warning valve and transmitter. If a tire goes flat, the tire pressure warning light will not turn off even though the flat tire has been replaced with the spare tire. Replace the spare tire with the repaired tire and adjust the tire inflation pressure. The tire pressure warning light will go off after a few minutes.

Vehicles with a full-size spare tire: The spare tire is also equipped with a tire pressure warning valve and transmitter. The tire pressure warning light will turn on if the tire inflation pressure of the spare tire is low. If a tire goes flat, the tire pressure warning light will not turn off even though the flat tire has been replaced with the spare tire. Replace the spare tire with the repaired tire and adjust the tire inflation pressure. The tire pressure warning light will go off after a few minutes.

■ **Conditions that the tire pressure warning system may not function properly**

→P.414

 **WARNING**

■ **If both the ABS and the brake system warning lights remain on**

Stop your vehicle in a safe place immediately and contact your Toyota dealer.

The vehicle will become extremely unstable during braking, and the ABS system may fail, which could cause an accident resulting in death or serious injury.

**⚠ WARNING****■ When the electric power steering system warning light comes on**

When the light comes on yellow, the assist to the power steering is restricted. When the light comes on red, the assist to the power steering is lost and handling operations of the steering wheel become extremely heavy. When steering wheel operations are heavier than usual, grip the steering wheel firmly and operate it using more force than usual.

**■ If the tire pressure warning light comes on**

Be sure to observe the following precautions. Failure to do so could cause a loss of vehicle control and result in death or serious injury.

- Stop your vehicle in a safe place as soon as possible. Adjust the tire inflation pressure immediately.
- Vehicles with a compact spare tire: If the tire pressure warning light comes on even after tire inflation pressure adjustment, it is probable that you have a flat tire. Check the tires. If a tire is flat, change it with the spare tire and have the flat tire repaired by the nearest Toyota dealer.
- Avoid abrupt maneuvering and braking. If the vehicle tires deteriorate, you could lose control of the steering wheel or the brakes.

**■ If a blowout or sudden air leakage should occur**

The tire pressure warning system may not activate immediately.

**■ Maintenance of the tires**

Each tire, including the spare (if provided), should be checked monthly when cold and inflated to the inflation pressure recommended by the vehicle manufacturer on the vehicle placard or tire inflation pressure label (tire and load information label). (If your vehicle has tires of a different size than the size indicated on the vehicle placard or tire inflation pressure label [tire and load information label], you should determine the proper tire inflation pressure for those tires.)

As an added safety feature, your vehicle has been equipped with a tire pressure monitoring system (TPMS-tire pressure warning system) that illuminates a low tire pressure telltale (tire pressure warning light) when one or more of your tires is significantly under-inflated. Accordingly, when the low tire pressure telltale (tire pressure warning light) illuminates, you should stop and check your tires as soon as possible, and inflate them to the proper pressure. Driving on a significantly under-inflated tire causes the tire to overheat and can lead to tire failure. Under-inflation also reduces fuel efficiency and tire tread life, and may affect the vehicle's handling and stopping ability.

Please note that the TPMS (tire pressure warning system) is not a substitute for proper tire maintenance, and it is the driver's responsibility to maintain correct tire pressure, even if under-inflation has not reached the level to trigger illumination of the TPMS low tire pressure telltale (tire pressure warning light).

**⚠ WARNING**

Your vehicle has also been equipped with a TPMS (tire pressure warning system) malfunction indicator to indicate when the system is not operating properly. The TPMS (tire pressure warning system) malfunction indicator is combined with the low tire pressure telltale (tire pressure warning light). When the system detects a malfunction, the telltale will flash for approximately one minute and then remain continuously illuminated. This sequence will continue upon subsequent vehicle start-ups as long as the malfunction exists. When the malfunction indicator is illuminated, the system may not be able to detect or signal low tire pressure as intended.

TPMS (tire pressure warning system) malfunctions may occur for a variety of reasons, including the installation of replacement or alternate tires or wheels on the vehicle that prevent the TPMS (tire pressure warning system) from functioning properly. Always check the TPMS (tire pressure warning system) malfunction telltale after replacing one or more tires or wheels on your vehicle to ensure that the replacement or alternate tires and wheels allow the TPMS (tire pressure warning system) to continue to function properly.

**⚠ NOTICE**

■ **To ensure the tire pressure warning system operates properly**

Do not install tires with different specifications or makers, as the tire pressure warning system may not operate properly.

**If a warning message is displayed**

The multi-information display shows warnings of system malfunctions, incorrectly performed operations, and messages that indicate a need for maintenance. When a message is shown, perform the correction procedure appropriate to the message.

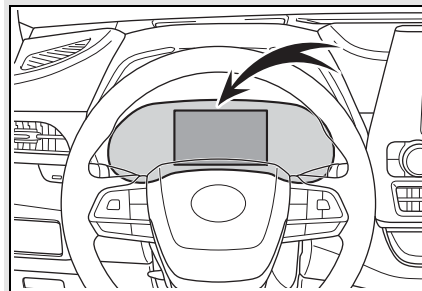

Additionally, if a warning light comes on or flashes at the same time that a warning message is displayed, take the appropriate corrective action for the warning light. (→P.450)

If a warning message is displayed again after the appropriate actions have been performed, contact your Toyota dealer.

**Messages and warnings**

The warning lights and warning buzzers operate as follows depending on the content of the message. If a message indicates the need for inspection by a dealer, have the vehicle inspected by your Toyota dealer immediately.

Warning light	Warning buzzer *	Warning
-	Sounds	<ul style="list-style-type: none"> <li>• Indicates an important situation, such as when a system related to driving is malfunctioning or that danger may result if the correction procedure is not performed</li> <li>• Indicates a situation, such as when damage to the vehicle or danger may result</li> </ul>
Comes on or flashes	Sounds	Indicates an important situation, such as when the systems shown on the multi-information display may be malfunctioning
-	Does not sound	<ul style="list-style-type: none"> <li>• Indicates a condition, such as malfunction of electrical components, their condition, or indicates the need for maintenance</li> <li>• Indicates a situation, such as when an operation has been performed incorrectly, or indicates how to perform an operation correctly</li> </ul>

\*: A buzzer sounds the first time a message is shown on the multi-information display.

**■ Warning messages**

The warning messages explained below may differ from the actual messages according to operation conditions and vehicle specifications.

**■ Warning buzzer**

In some cases, the buzzer may not be heard due to being in a noisy location or audio sound.

**■ If “Engine Oil Level Low Add or Replace” is displayed**

The engine oil level is low. Check the level of the engine oil, and add if necessary.

This message may appear if the vehicle is stopped on a slope. Move the vehicle to a level surface and check to see if the message disappears.

## 462 7-2. Steps to take in an emergency

### ■ If “Engine Stopped Steering Power Low” is displayed

This message is displayed if the engine is stopped while driving.

When steering wheel operations are heavier than usual, grip the steering wheel firmly and operate it using more force than usual.

### ■ If “Shift to P when Parked” is displayed

This message is displayed when the driver’s door is opened without turning the engine switch off with the shift lever in any position other than P. Change the shift lever to P.

### ■ If “Auto Power OFF to Conserve Battery” is displayed

Power was cut off due to the automatic power off function. Next time when starting the engine, increase the engine speed slightly and maintain that level for approximately 5 minutes to recharge the battery.

### ■ If “Headlight System Malfunction Visit Your Dealer” is displayed

The following systems may be malfunctioning. Have the vehicle inspected by your Toyota dealer immediately.

- The LED headlight system (if AFS [Adaptive Front-lighting System] equipped)
- AFS (Adaptive Front-lighting System) (if equipped)
- The automatic headlight leveling system (if equipped)
- Automatic High Beam

### ■ If “Radar Cruise Control Unavailable” is displayed

The dynamic radar cruise control with full-speed range system cannot be used temporarily. Use the system when it becomes available again.

### ■ If “Front Camera Unavailable” or “Front Camera Unavailable See Owner’s Manual” is displayed

The following systems may be suspended until the problem shown in the message is resolved. (→P.231, 456)

- PCS (Pre-Collision system)
- LTA (Lane Tracing Assist)
- Automatic High Beam
- RSA (Road Sign Assist) (if equipped)
- Dynamic radar cruise control with full-speed range

### ■ If “AWD System Overheated Switching to 2WD Mode” or “AWD System Overheated 2WD Mode Engaged” is displayed (AWD models)

This message may be displayed when driving under extremely high load conditions.

Drive the vehicle at low speeds or stop the vehicle in a safe place with the engine running until the message is cleared.

If the message is not cleared, have the vehicle inspected by your Toyota dealer.

### ■ If “Check Fuel Cap” is displayed

The fuel tank cap is not properly installed. Correctly install the fuel tank cap.

### ■ If “Maintenance Required Soon” is displayed

Indicates that all maintenance according to the driven distance on the maintenance schedule\* should be performed soon.

Comes on approximately 4500 miles (7200 km) after the message has been reset. If necessary, perform maintenance. Please reset the message after the maintenance is performed. (→P.395)

\*: Refer to the separate “Scheduled Maintenance” or “Owner’s Manual Supplement” for the maintenance interval applicable to your vehicle.

■ **If “Maintenance Required Visit Your Dealer” is displayed**

Indicates that all maintenance is required to correspond to the driven distance on the maintenance schedule\*.

Comes on approximately 5000 miles (8000 km) after the message has been reset. (The indicator will not work properly unless the message has been reset.) Perform the necessary maintenance. Please reset the message after the maintenance is performed. (→P.395)

\*: Refer to the separate “Scheduled Maintenance” or “Owner’s Manual Supplement” for the maintenance interval applicable to your vehicle.

■ **If “Oil Maintenance Required Soon” is displayed**

Indicates that the engine oil should be scheduled to be changed.

Check the engine oil and change it if necessary. After changing the engine oil, make sure to reset the message. (→P.394)

■ **If “Oil Maintenance Required” is displayed**

Indicates that the engine oil should be changed.

Check and change the engine oil, and oil filter by your Toyota dealer. After changing the engine oil, make sure to reset the message. (→P.394)

■ **If a message that indicates the need for visiting your Toyota dealer is displayed**

The system or part shown on the multi-information display is malfunctioning. Have the vehicle inspected by your Toyota dealer immediately.

tioning. Have the vehicle inspected by your Toyota dealer immediately.

■ **If a message that indicates the need for referring to Owner’s Manual is displayed**

● If any of the following messages are shown on the multi-information display, it may indicate a malfunction. Immediately stop the vehicle and contact your Toyota dealer.

- “Braking Power Low Stop in a Safe Place See Owner’s Manual”
- “Oil Pressure Low Stop in a Safe Place See Owner’s Manual”
- “Charging System Malfunction Stop in a Safe Place See Owner’s Manual”

● If “Smart Key System Malfunction See Owner’s Manual” is shown on the multi-information display, it may indicate a malfunction. Have the vehicle inspected by your Toyota dealer immediately.

● If any of the following messages are shown on the multi-information display, follow the instructions.

- “Engine Coolant Temp High Stop in a Safe Place See Owner’s Manual” (→P.487)
- “High Transmission Fluid Temp See Owner’s Manual” (→P.204)

 NOTICE

■ **If “High Power Consumption Partial Limit on AC/Heater Operation” is displayed frequently**

There is a possible malfunction relating to the charging system or the battery may be deteriorating. Have the vehicle inspected by your Toyota dealer.

### If you have a flat tire

Your vehicle is equipped with a spare tire. The flat tire can be replaced with the spare tire.

For details about tires:  
→P.411

### WARNING

#### ■ If you have a flat tire

Do not continue driving with a flat tire.  
Driving even a short distance with a flat tire can damage the tire and the wheel beyond repair, which could result in an accident.

### Before jacking up the vehicle

- Stop the vehicle in a safe place on a hard, flat surface.
- Set the parking brake.
- Shift the shift lever to P.
- Stop the engine.
- Turn on the emergency flashers. (→P.442)
- For vehicles with power back door: Turn off the power back door system. (→P.515)



**Location of the spare tire, jack and tools**

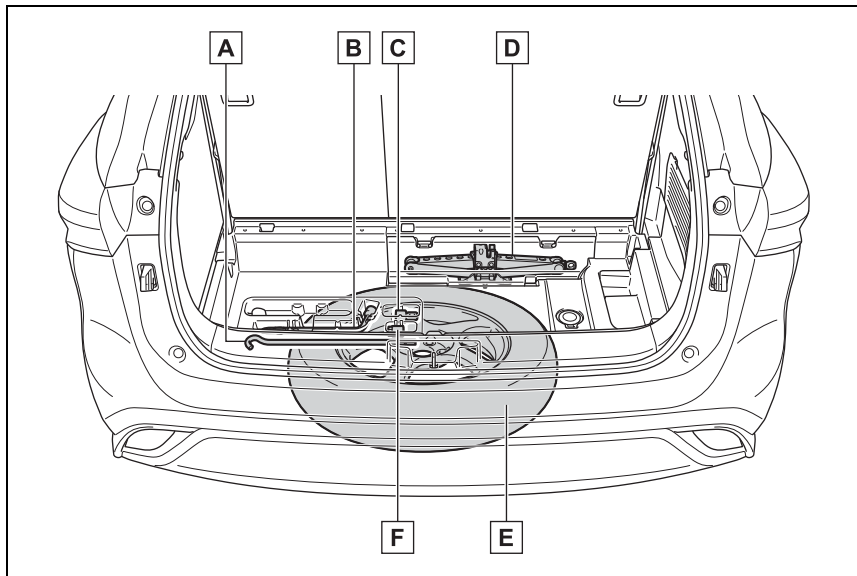

- A** Jack handle
- B** Wheel nut wrench
- C** Adapter socket
- D** Jack
- E** Spare tire
- F** Wheel lock key (if equipped)

**⚠ WARNING**

**■ Using the tire jack**

Observe the following precautions. Improper use of the tire jack may cause the vehicle to suddenly fall off the jack, leading to death or serious injury.

- Do not use the tire jack for any purpose other than replacing tires or installing and removing tire chains.

- Only use the tire jack that comes with this vehicle for replacing a flat tire. Do not use it on other vehicles, and do not use other tire jacks for replacing tires on this vehicle.

**⚠ WARNING**

- Put the jack properly in its jack point.

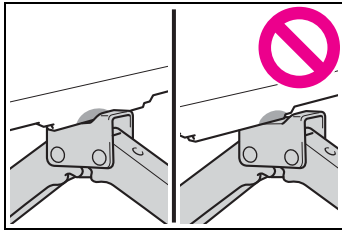

- Do not put any part of your body under the vehicle while it is supported by the jack.
- Do not start the engine or drive the vehicle while the vehicle is supported by the jack.
- Do not raise the vehicle while someone is inside.
- When raising the vehicle, do not put an object on or under the jack.
- Do not raise the vehicle to a height greater than that required to replace the tire.
- Use a jack stand if it is necessary to get under the vehicle.
- When lowering the vehicle, make sure that there is no-one near the vehicle. If there are people nearby, warn them vocally before lowering.

**Wheel lock nut (if equipped)**

When replacing tires on a vehicle with wheel lock nuts, use the following procedures to remove and install the wheel lock nuts. The wheel lock key is stored in the tray inside the luggage com-

partment. Always return the wheel lock key to its original position after use, so that it does not get lost. (→P.465)

■ **Removal**

For ease of removal, the wheel lock nut should always be the first one loosened.

- 1 Place the wheel lock key on top of the wheel lock nut, turning until the wheel lock key and wheel lock nut patterns engage.
- 2 Place the wheel nut wrench on the wheel lock key, and while applying pressure on the wheel lock key, loosen the wheel lock nut.

■ **Installation**

For ease of installation, the wheel lock nut should always be the last one tightened.

- 1 By hand, install a wheel lock nut on each wheel.
- 2 Place the wheel lock key on top of the wheel lock nut, turning until the wheel lock key and wheel lock nut patterns engage.
- 3 Place the wheel nut wrench on the wheel lock key, and while applying pressure on the wheel lock key, tighten the wheel lock nut to the recommended torque.

 **NOTICE**  
**■ When using a wheel lock key (if equipped)**  
 Do not use an impact wrench. Using an impact wrench may cause permanent damage to wheel lock nut and wheel lock key. If in doubt about wheel lock application, contact your Toyota dealer.

**Taking out the jack**

**1** Pull the strap upwards and open the center deck board.

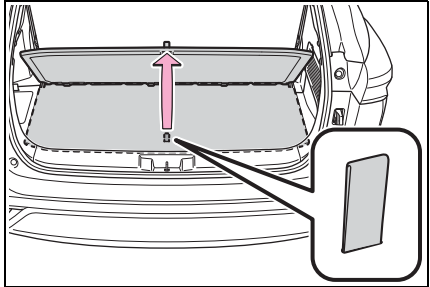

**2** Remove the center deck board.

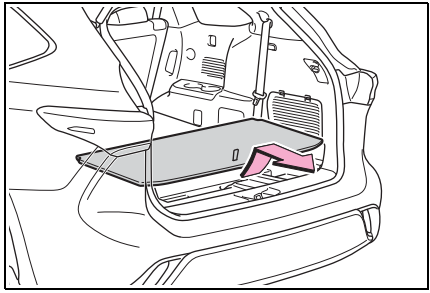

**3** Remove the jack cover.

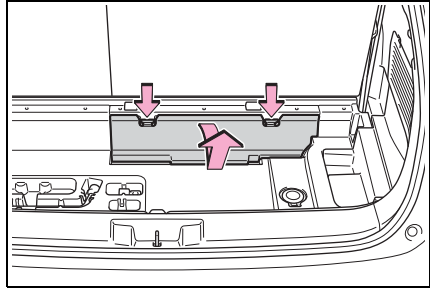

**4** Remove the jack after removing the hook.

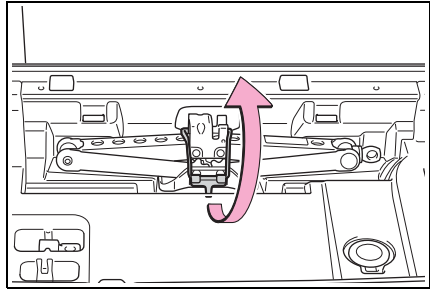

**Taking out the spare tire**

**1** Pull the strap upwards and open the center deck board.

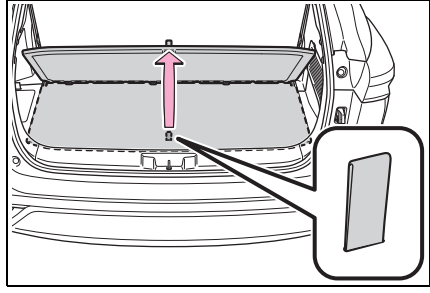

7  
 When trouble arises

**468** 7-2. Steps to take in an emergency

- 2** Remove the center deck board.

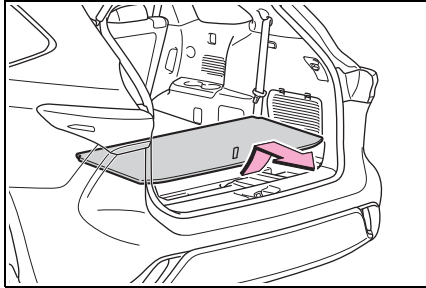

- 3** Remove the cover.

If it is difficult to remove the cover, you can use your key.

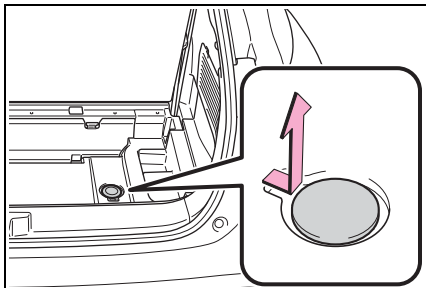

- 4** Attach the adapter socket to the spare tire clamp bolt.

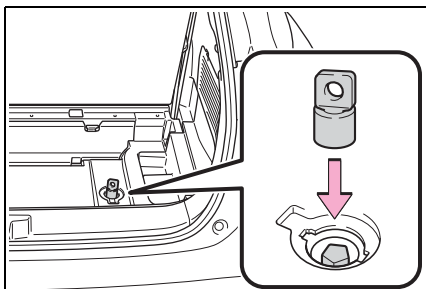

- 5** Connect the jack handle extension to the jack handle.

Check that the extension is locked

in place by the button.

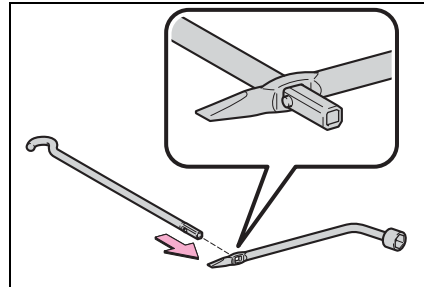

- 6** Connect the jack handle to the adapter socket. Turn the jack handle counterclockwise.

The tire will be lowered completely to the ground.

Turn the jack handle slowly to lower the spare tire. If the handle is turned quickly, the wire cable may slip off of the shaft inside the unit and the tire may not be lowered.

If the spare tire cannot be lowered:  
→P.471

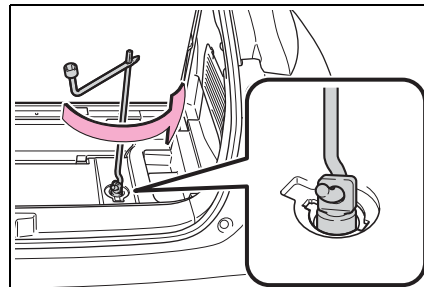

**7** Pull out the spare tire and stand it against the bumper.

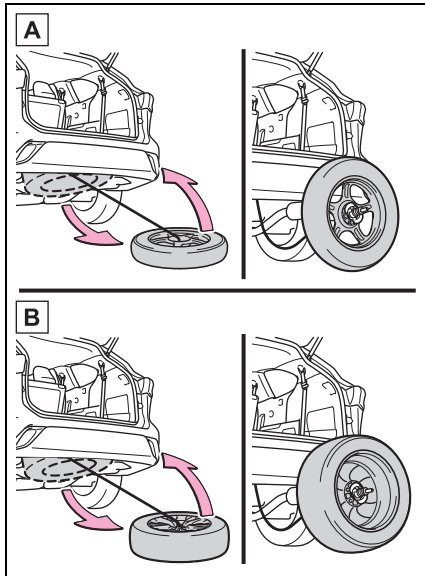

- A** With a compact spare tire
- B** With a full-size spare tire
- ▶ Vehicles with a compact spare tire
- 8** Fully depress the secondary latch **A** and remove the

holding bracket **B** from the hoist assembly **C**.

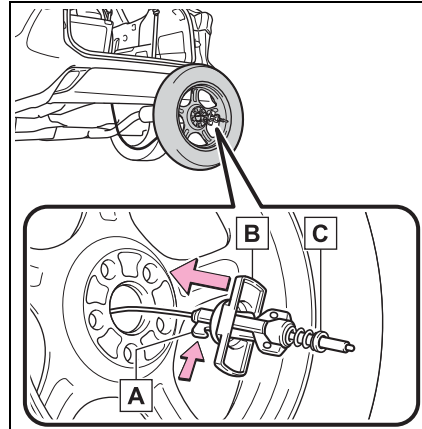

**9** Tilt the bracket **B** and pass it through the wheel opening. Then remove the hoist assembly **C**.

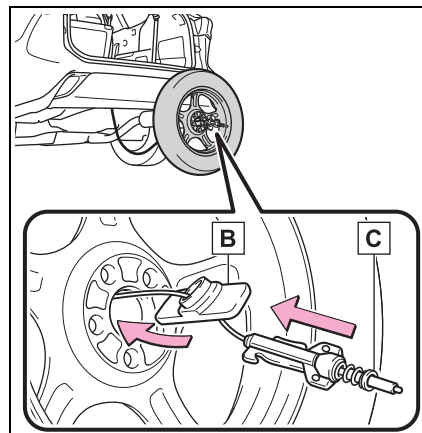

- ▶ Vehicles with a full-size spare tire
- 8** Fully depress the secondary latch **A** and remove the

**470** 7-2. Steps to take in an emergency

holding bracket **B** from the hoist assembly **C**.

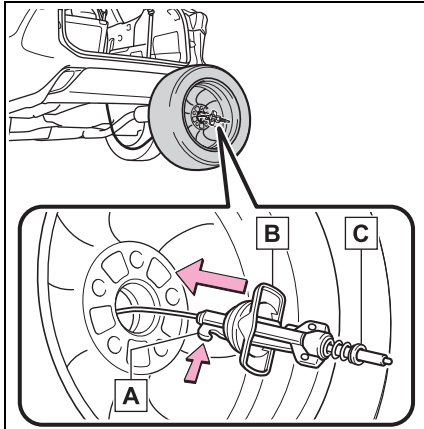

- 9** Tilt the holding bracket **B** so that it can easily be passed through the wheel opening. After passing the holding bracket through the wheel opening, remove the hoist assembly **C**.

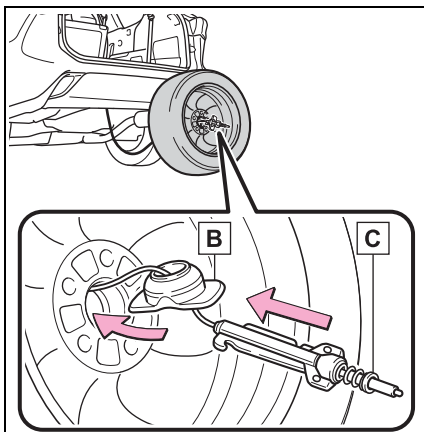

**! WARNING**

**When storing the spare tire**

Be careful not to catch fingers or other body parts between the spare tire and the body of the vehicle.

**Replacing a flat tire**

- 1** Chock the tires.

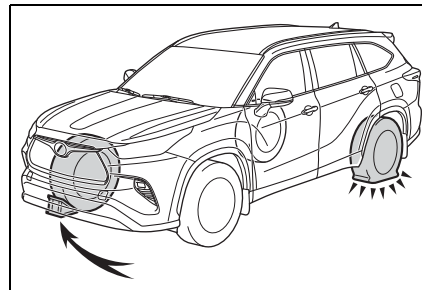

Flat tire	Wheel chock positions
Front left-hand side	Behind the rear right-hand side tire
Front right-hand side	Behind the rear left-hand side tire
Rear left-hand side	In front of the front right-hand side tire
Rear right-hand side	In front of the front left-hand side tire

- 2** Slightly loosen the wheel nuts (one turn).

Vehicles with wheel locks: Use the wheel lock key to loosen the wheel

lock.

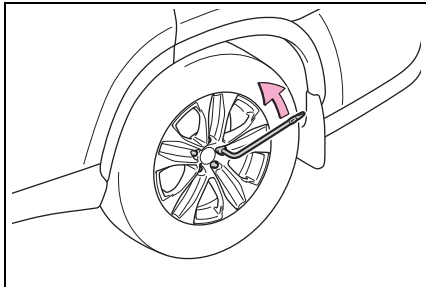

- 3** Turn the tire jack portion **A** by hand until the notch of the jack is in contact with the jack point.

The jack point guides are located under the rocker panel. They indicate the jack point positions.

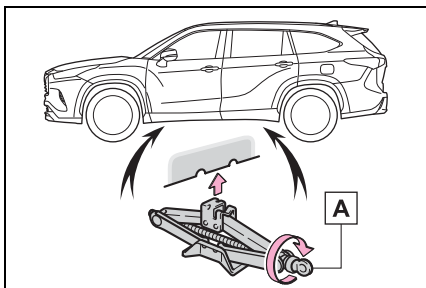

- 4** Raise the vehicle until the tire is slightly raised off the ground.

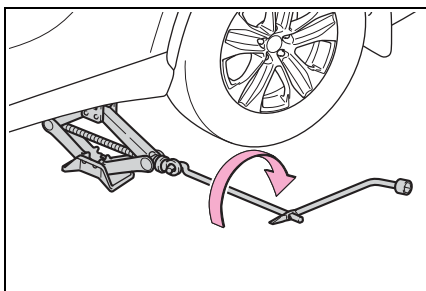

- 5** Remove all the wheel nuts and the tire.

When resting the tire on the

ground, place the tire so that the wheel design faces up to avoid scratching the wheel surface.

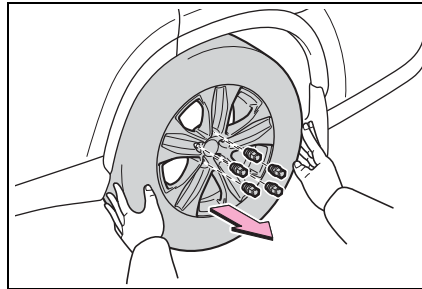

**■ If the spare tire cannot be lowered**

If the spare tire cannot be lowered, it may not have been stowed properly. Perform the following procedure:

- 1** Fully tighten the spare tire clamp bolt by turning the jack handle clockwise until two clicks are heard and the jack handle skips.

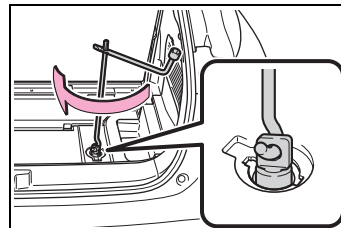

- 2** Turn the jack handle counterclockwise to lower the spare tire.

If the spare tire still cannot be lowered, attempt to fully tighten the spare tire clamp bolt again by turning the jack handle clockwise. Then turn it counterclockwise at least 2 turns to lower the spare tire.

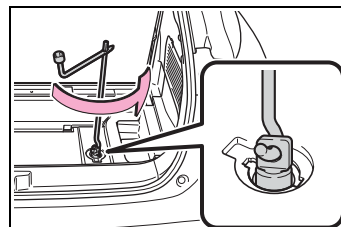

If the spare tire still cannot be low-

## 472 7-2. Steps to take in an emergency

ered, the wire cable may be severed. Have the vehicle inspected by your Toyota dealer.

### **WARNING**

#### ■ Replacing a flat tire

- Do not touch the disc wheels or the area around the brakes immediately after the vehicle has been driven. After the vehicle has been driven the disc wheels and the area around the brakes will be extremely hot. Touching these areas with hands, feet or other body parts while changing a tire, etc. may result in burns.
- Failure to follow these precautions could cause the wheel nuts to loosen and the tire to fall off, resulting in death or serious injury.
- Never use oil or grease on the wheel bolts or wheel nuts. Oil and grease may cause the wheel nuts to be excessively tightened, leading to bolt or disc wheel damage. In addition, the oil or grease can cause the wheel nuts to loosen and the wheel may fall off, causing an accident and resulting in death or serious injury. Remove any oil or grease from the wheel bolts or wheel nuts.
- Have the wheel nuts tightened with a torque wrench to 76 ft•lbf (103 N•m, 10.5 kgf•m) as soon as possible after changing wheels.
- When installing a tire, only use wheel nuts that have been specifically designed for that wheel.

- If there are any cracks or deformations in the bolt screws, nut threads or bolt holes of the wheel, have the vehicle inspected by your Toyota dealer.
- Do not attach a heavily damaged wheel ornament, as it may fly off the wheel while the vehicle is moving.
- Observe the following precautions. Failure to do so may result in serious injury:
- Do not try to remove the wheel ornament by hand. Take due care in handling the ornament to avoid unexpected personal injury.
- Lower the spare tire completely to the ground before removing it from under the vehicle.

#### ■ Replacing a flat tire for vehicles with power back door

In cases such as when replacing tires, make sure to turn off the power back door main switch (→P.515). Failure to do so may cause the back door to operate unintentionally if the power back door switch is accidentally touched, resulting in hands and fingers being caught and injured.

### **Installing the spare tire**

- 1 Remove any dirt or foreign matter from the wheel contact surface.

If foreign matter is on the wheel contact surface, the wheel nuts may loosen while the vehicle is in



motion, causing the tire to come off.

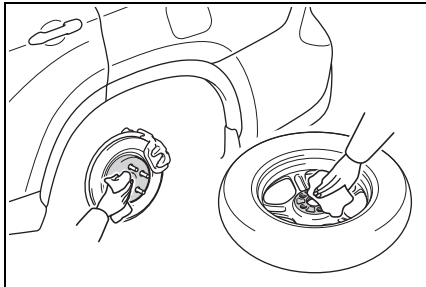

- 2** Install the spare tire and loosely tighten each wheel nut by hand by approximately the same amount.

Turn the wheel nuts until the washers come into contact with the disc wheel.

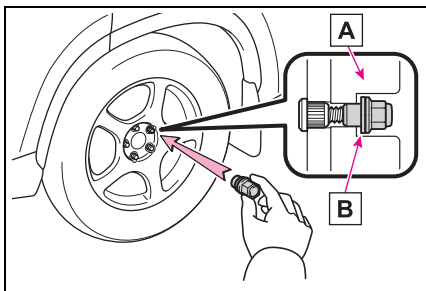

- A** Disc wheel
- B** Washer

- 3** Lower the vehicle.

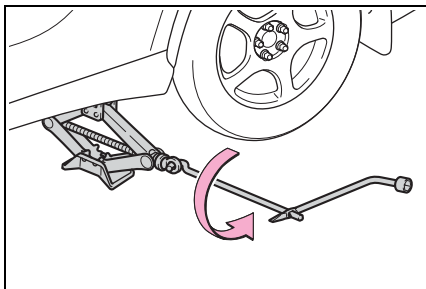

- 4** Firmly tighten each wheel nut two or three times in the

order shown in the illustration.

Vehicles with wheel locks: Tighten the wheel lock using the wheel lock key after tightening the other wheel nuts.

Tightening torque:  
76 ft•lbf (103 N•m, 10.5 kgf•m)

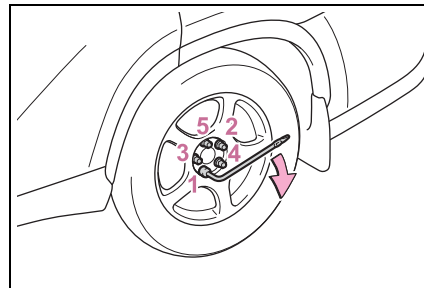

**WARNING**

**Stowing the flat tire**

Failure to follow steps listed under stowing the tire may result in damage to the spare tire carrier and loss of the tire, which could result in serious injury or death.

**Stowing the flat tire, jack and all tools**

- 1** Remove the center wheel ornament by pushing from the reverse side.

Be careful not to lose the wheel ornament.

- 2** Stand the tire against the bumper with the inner surface facing toward you. Pass the hoist assembly **C** and

**474** 7-2. Steps to take in an emergency

holding bracket **B** through the wheel opening.

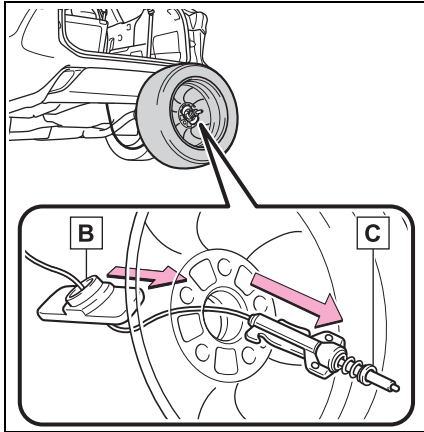

**3** Fully depress the secondary latch **A** and install the bracket **B** to the hoist assembly **C**.

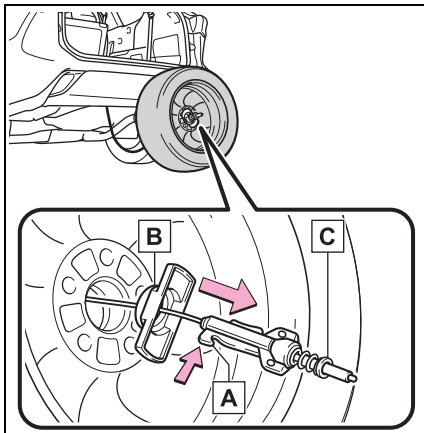

**4** Lay the tire on the ground with the outer surface (valve stem) facing up.

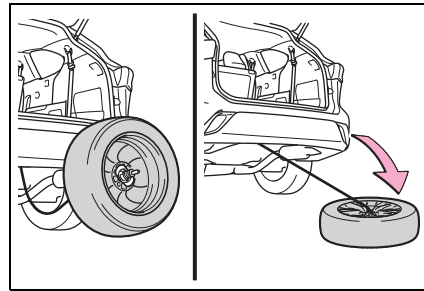

**5** Before raising the tire, make sure that the hoist assembly is perpendicular to the wheel opening. (Try to place the tire directly beneath the vehicle, near where the wire cable is hanging from.)

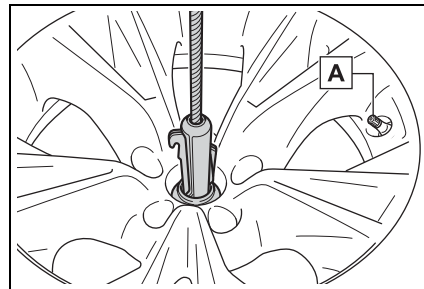

**A** Valve stem

**6** Using the jack handle and adapter socket, tighten the tire clamp bolt by turning it clockwise until the tire is in the correct position and two clicks are heard as the jack handle skips.

- 7** Confirm it is not loose after tightening:

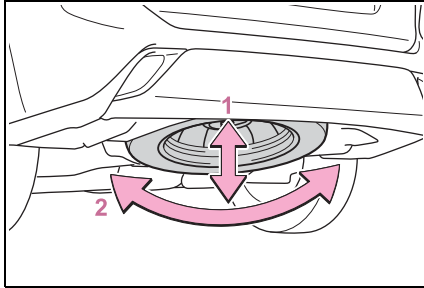

- 1** Push and pull the tire  
**2** Try rotating

Visually check to ensure tire is not hung on surrounding parts. If looseness or misassembly exists, repeat steps **2** to **7**.

- 8** Repeat step **7**, any time the tire is lowered or disturbed.  
**9** Stow the jack and all tools.

■ **The compact spare tire (vehicles with a compact spare tire)**

- The compact spare tire is identified by the label "TEMPORARY USE ONLY" on the tire sidewall. Use the compact spare tire temporarily, and only in an emergency.
- Make sure to check the tire inflation pressure of the compact spare tire. (→P.499)

■ **When using the compact spare tire (vehicles with a compact spare tire)**

As the compact spare tire is not equipped with a tire pressure warning valve and transmitter, low inflation pressure of the spare tire will not be indicated by the tire pressure warning system. Also, if you replace the compact spare tire after the tire pressure warning light comes on, the light remains on.

■ **When the compact spare tire is equipped (vehicles with a compact spare tire)**

When driving with the compact spare tire installed, the vehicle height will be different than when driving with standard tires.

■ **If you have a flat front tire on a road covered with snow or ice (vehicles with a compact spare tire)**

Install the compact spare tire on one of the rear wheels of the vehicle. Perform the following steps and fit tire chains to the front tires:

- 1** Replace a rear tire with the compact spare tire.
- 2** Replace the flat front tire with the tire removed from the rear of the vehicle.
- 3** Fit tire chains to the front tires.

**⚠ WARNING**

■ **When using the compact spare tire (vehicles with a compact spare tire)**

- Remember that the compact spare tire provided is specifically designed for use with your vehicle. Do not use your compact spare tire on another vehicle.
- Do not use more than one compact spare tire simultaneously.
- Replace the compact spare tire with a standard tire as soon as possible.
- Avoid sudden acceleration, abrupt steering, sudden braking and shifting operations that cause sudden engine braking.

 **WARNING**

■ **When the compact spare tire is attached (vehicles with a compact spare tire)**

The vehicle speed may not be correctly detected, and the following systems may not operate correctly:

- ABS & Brake assist
- VSC
- TRAC
- Trailer Sway Control (if equipped)
- EPS
- Dynamic radar cruise control with full-speed range
- PCS (Pre-Collision System)
- LTA (Lane Tracing Assist)
- RSA (Road Sign Assist) (if equipped)
- Automatic High Beam
- AFS (Adaptive Front-lighting System) (if equipped)
- Tire pressure warning system
- Intuitive parking assist (if equipped)
- PKSB (Parking Support Brake) (if equipped)
- Toyota parking assist monitor (if equipped)
- Panoramic view monitor (if equipped)
- BSM (Blind Spot Monitor) (if equipped)
- Navigation system (if equipped)

Also, not only can the following system not be utilized fully, but it may even negatively affect the drive-train components:

- AWD system (AWD models)

■ **Speed limit when using the compact spare tire (vehicles with a compact spare tire)**

Do not drive at speeds in excess of 50 mph (80 km/h) when a compact spare tire is installed on the vehicle.

The compact spare tire is not designed for driving at high speeds. Failure to observe this precaution may lead to an accident causing death or serious injury.

■ **After using the tools and jack**

Before driving, make sure all the tools and jack are securely in place in their storage location to reduce the possibility of personal injury during a collision or sudden braking.

 **NOTICE**

■ **Be careful when driving over bumps with the compact spare tire installed on the vehicle (vehicles with a compact spare tire)**

The vehicle becomes lower when driving with the compact spare tire compared to when driving with standard tires. Be careful when driving over uneven road surfaces.

 NOTICE

■ **Driving with tire chains and the compact spare tire (vehicles with a compact spare tire)**

Do not fit tire chains to the compact spare tire.  
Tire chains may damage the vehicle body and adversely affect driving performance.

■ **When replacing the tires**

When removing or fitting the wheels, tires or the tire pressure warning valve and transmitter, contact your Toyota dealer as the tire pressure warning valve and transmitter may be damaged if not handled correctly.

■ **When stowing the flat tire**

- Ensure that there is no object caught between the tire and the vehicle underbody.
- Securely tighten the spare tire clamp bolt to hold the spare wheel carrier by the hook.
- Stow the flat tire in the spare tire location. Failure to do so may cause damage to the spare tire carrier. Proper storage reduces the possibility of injury in a collision or during sudden braking.
- Have the flat tire repaired and the spare tire replaced with it as soon as possible.

■ **Proper storage of the spare tire**

- If the hoist assembly is slanted when stowing a tire, the hoist assembly may become stuck in the wheel opening and the tire may not be raised properly, causing damage to the wheel or the wire cable.

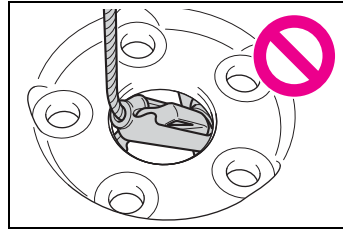

- Do not attempt to turn the spare tire clamp bolt without a tire on the hoist assembly, as doing so may cause the wire cable to slip off of the shaft inside the unit and the wire cable may not be able to be raised or lowered. If the spare tire clamp bolt has been turned without a tire on the hoist assembly and the wire cable cannot be raised or lowered, contact your Toyota dealer.

**If the engine will not start**

**If the engine will not start even though correct starting procedures are being followed (→P.200), consider each of the following points:**

**The engine will not start even though the starter motor operates normally.**

One of the following may be the cause of the problem:

- There may not be sufficient fuel in the vehicle's tank. Refuel the vehicle.
- The engine may be flooded. Try to restart the engine again following correct starting procedures. (→P.200)
- There may be a malfunction in the engine immobilizer system. (→P.69)

**The starter motor turns over slowly, the interior lights and headlights are dim, or the horn does not sound or sounds at a low volume.**

One of the following may be the cause of the problem:

- The battery may be discharged. (→P.483)

- The battery terminal connections may be loose or corroded. (→P.408)

**The starter motor does not turn over**

The engine starting system may be malfunctioning due to an electrical problem such as electronic key battery depletion or a blown fuse. However, an interim measure is available to start the engine. (→P.478)

**The starter motor does not turn over, the interior lights and headlights do not turn on, or the horn does not sound.**

One of the following may be the cause of the problem:

- One or both of the battery terminals may be disconnected. (→P.408)
- The battery may be discharged. (→P.483)
- There may be a malfunction in the steering lock system.

Contact your Toyota dealer if the problem cannot be repaired, or if repair procedures are unknown.

**Starting the engine in an emergency**

When the engine does not start, the following steps can be used

as an interim measure to start the engine if the engine switch is functioning normally.

Do not use this starting procedure except in cases of emergency.

- 1** Pull the parking brake switch to check that the parking brake is set. (→P.209)

Parking brake indicator will come on.

- 2** Shift the shift lever to P.
- 3** Turn the engine switch to ACC.
- 4** Press and hold the engine switch for about 15 seconds while depressing the brake pedal firmly.

Even if the engine can be started using the above steps, the system may be malfunctioning. Have the vehicle inspected by your Toyota dealer.

### If you lose your keys

**New genuine mechanical keys can be made by your Toyota dealer using another mechanical key and the key number stamped on your key number plate.**

**Keep the plate in a safe place such as your wallet, not in the vehicle.**



#### NOTICE

#### ■ When an electronic key is lost

If the electronic key remains lost, the risk of vehicle theft increases significantly. Visit your Toyota dealer immediately with all remaining electronic keys that were provided with your vehicle.

**If the fuel filler door cannot be opened**

**If the fuel filler door opener switch cannot be operated, contact your Toyota dealer to service the vehicle. In case where refueling is urgently necessary, the following procedure can be used to open the fuel filler door.**

**Opening the fuel filler door**

- If the fuel filler door opener switch cannot be operated, remove the cover inside the luggage compartment and pull the lever to open the fuel filler door.

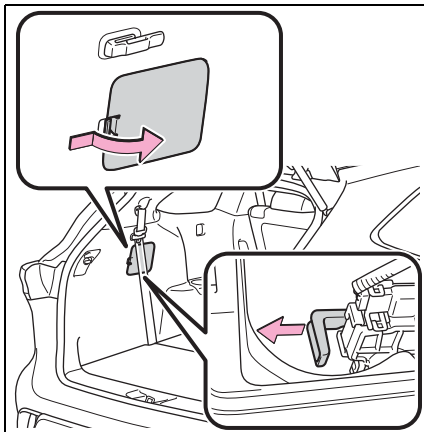

- Using the lever to open the fuel filler door may not allow for an adequate reduction in fuel tank pressure before refueling. To prevent fuel from

spilling out, turn the cap slowly when removing it. During refueling, fuel may spill out from the filler opening due to air being discharged from inside the fuel tank. Therefore, fill the fuel tank carefully and slowly.



**If the electronic key does not operate properly**

**If communication between the electronic key and vehicle is interrupted (→P.132) or the electronic key cannot be used because the battery is depleted, the smart key system and wireless remote control cannot be used. In such cases, the doors can be opened and the engine can be started by following the procedure below.**

**■ When the electronic key does not work properly**

- Make sure that the smart key system has not been deactivated in the customization setting. If it is off, turn the function on. (Customizable features: →P.515)
- Check if battery-saving mode is set. If it is set, cancel the function. (→P.132)

**Locking and unlocking the doors**

**■ Unlocking the door**

Use the mechanical key (→P.114) in order to perform the following operations:

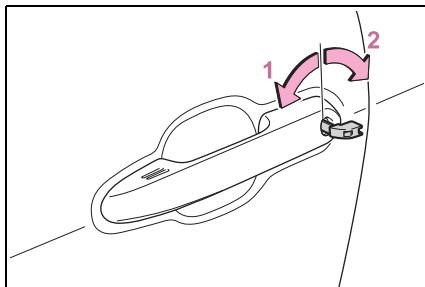

- 1** Locks all the doors
- 2** Unlocks all the doors

Turning the key unlocks the driver's door. Turning the key again unlocks the other doors.

**■ Key linked functions**

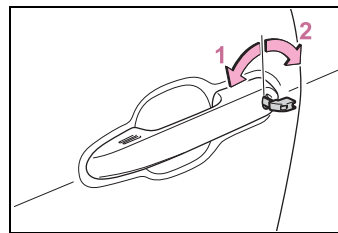

- 1** Closes the windows and the moon roof\* (turn and hold)
- 2** Opens the windows and the moon roof\* (turn and hold)

These settings must be customized at your Toyota dealer.

\*: If equipped

**⚠ WARNING**

**■ When using the mechanical key and operating the power windows or moon roof (if equipped)**

Operate the power window or moon roof after checking to make sure that there is no possibility of any passenger having any of their body parts caught in the window or moon roof. Also, do not allow children to operate the mechanical key. It is possible for children and other passengers to get caught in the power window or moon roof.

### Starting the engine

- 1 Ensure that the shift lever is in P and depress the brake pedal.
- 2 Touch the Toyota emblem side of the electronic key to the engine switch.

When the electronic key is detected, a buzzer sounds and the engine switch will turn to ON.

When the smart key system is deactivated in customization setting, the engine switch will turn to ACC.

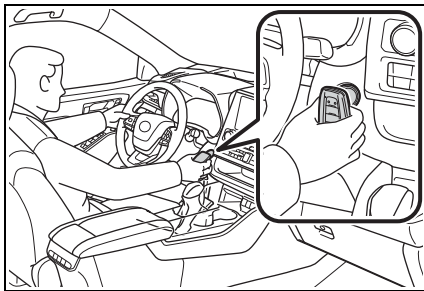

- 3 Firmly depress the brake pedal and check that  is shown on the multi-information display.
- 4 Press the engine switch shortly and firmly.

In the event that the engine still cannot be started, contact your Toyota dealer.

---

### Stopping the engine

Shift the shift lever to P, set the parking brake, and press the engine switch as you normally do when stopping the engine.

### Replacing the key battery

As the above procedure is a tempo-

rary measure, it is recommended that the electronic key battery be replaced immediately when the battery is depleted. (→P.428)

### Changing engine switch modes

Release the brake pedal and press the engine switch in step 3 above. The engine does not start and modes will be changed each time the switch is pressed. (→P.203)

**If the vehicle battery is discharged**

The following procedures may be used to start the engine if the vehicle's battery is discharged. You can also call your Toyota dealer or a qualified repair shop.

**Restarting the engine**

If you have a set of jumper (or booster) cables and a second vehicle with a 12-volt battery, you can jump start your vehicle by following the steps below.

- 1 Confirm that the electronic key is being carried.

Vehicles with an alarm: When connecting the jumper (or booster) cables, depending on the situation, the alarm may activate and doors locked. (→P.72)

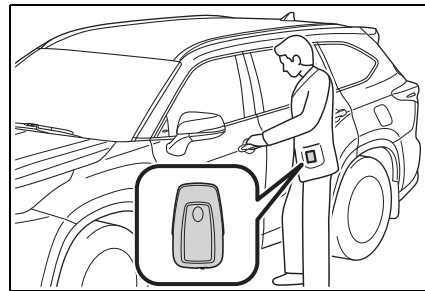

- 2 Open the hood. (→P.402)

- 3 Connect a positive jumper cable clamp to **A** on your vehicle and connect the clamp on the other end of the positive cable to **B** on the second vehicle. Then, connect a negative cable clamp to **C**

## 484 7-2. Steps to take in an emergency

on the second vehicle and connect the clamp at the other end of the negative cable to **D**.

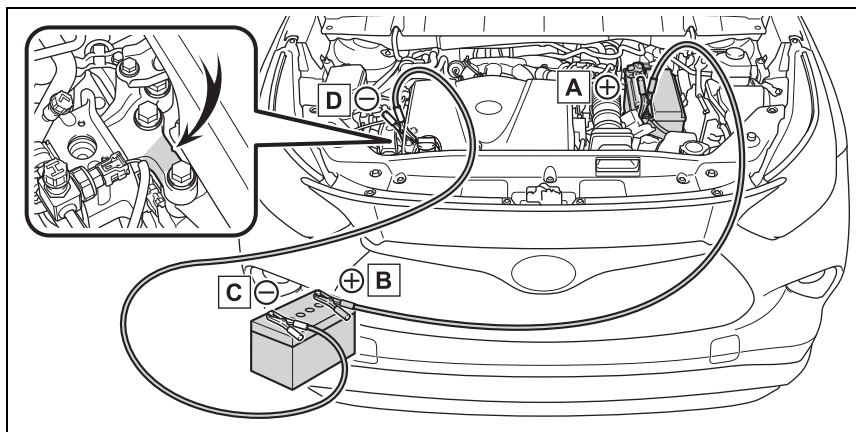

- A** Positive (+) battery terminal (your vehicle)
- B** Positive (+) battery terminal (second vehicle)
- C** Negative (-) battery terminal (second vehicle)
- D** Solid, stationary, unpainted metallic point away from the battery and any moving parts as shown in the illustration

**4** Start the engine of the second vehicle. Increase the engine speed slightly and maintain at that level for approximately 5 minutes to recharge the battery of your vehicle.

**5** Open and close any of the doors of your vehicle with the engine switch OFF.

**6** Maintain the engine speed of the second vehicle and start the engine of your vehicle by turning the engine switch to ON.

**7** Once the vehicle's engine has started, remove the jumper cables in the exact

reverse order from which they were connected.

Once the engine starts, have the vehicle inspected at your Toyota dealer as soon as possible.

### ■ Starting the engine when the battery is discharged

The engine cannot be started by push-starting.

### ■ To prevent battery discharge

- Turn off the headlights and the audio system while the engine is stopped. (Vehicles with Stop & Start system: Except when the engine is stopped by the Stop & Start system.)
- Turn off any unnecessary electrical components when the vehicle is running at a low speed for an extended period, such as in heavy

traffic.

■ **When the battery is removed or discharged**

- Information stored in the ECU is cleared. When the battery is depleted, have the vehicle inspected at your Toyota dealer.
- Some systems may require initialization. (→P.527)

■ **When removing the battery terminals**

When the battery terminals are removed, the information stored in the ECU is cleared. Before removing the battery terminals, contact your Toyota dealer.

■ **Charging the battery**

The electricity stored in the battery will discharge gradually even when the vehicle is not in use, due to natural discharge and the draining effects of certain electrical appliances. If the vehicle is left for a long time, the battery may discharge, and the engine may be unable to start. (The battery recharges automatically during driving.)

■ **After jump starting the vehicle (Vehicles with Stop & Start system)**

Be sure to disable the Stop & Start system so that the battery can be charged. (→P.265)

■ **When recharging or replacing the battery**

- In some cases, it may not be possible to unlock the doors using the smart key system when the battery is discharged. Use the wireless remote control or the mechanical key to lock or unlock the doors.
- The engine may not start on the first attempt after the battery has recharged but will start normally after the second attempt. This is not a malfunction.
- The engine switch mode is memo-

rized by the vehicle. When the battery is reconnected, the system will return to the mode it was in before the battery was discharged. Before disconnecting the battery, turn the engine switch off. If you are unsure what mode the engine switch was in before the battery discharged, be especially careful when reconnecting the battery.

- Vehicles with power back door: The power back door must be initialized. (→P.126)
- Vehicles with Stop & Start system: For a while after the battery terminals have been disconnected and reconnected, for a while after the battery has been replaced, the Stop & Start system may not automatically stop the engine for approximately 5 to 60 minutes.

■ **When replacing the battery**

- Use a Central Degassing type battery (European Regulations).
- Vehicles with Stop & Start system: Use a genuine battery specifically designed for use with the Stop & Start system or a battery with equivalent specifications to a genuine battery. If an unsupported battery is used, Stop & Start system functions may be restricted to protect the battery. Also, battery performance may decrease and the engine may not be able to restart. Contact your Toyota dealer for details.
- Vehicles without Stop & Start system: Use a battery that the case size is same as the previous one (LN3), 20 hour rate capacity (20HR) is equivalent (70Ah) or greater, and performance rating (CCA) is equivalent (603A) or greater.

Vehicles with Stop & Start system: Use a battery that the case size is same as the previous one (LN3), 20 hour rate capacity (20HR) is equivalent

lent (65Ah) or greater, and performance rating (CCA) is equivalent (603A) or greater.

- If the sizes differ, the battery cannot be properly secured.
- If the 20 hour rate capacity is low, even if the time period where the vehicle is not used is a short time, the battery may discharge and the engine may not be able to start.

For details, consult your Toyota dealer.

 **WARNING**

**■ When removing the battery terminals**

Always remove the negative (-) terminal first. If the positive (+) terminal contacts any metal in the surrounding area when the positive (+) terminal is removed, a spark may occur, leading to a fire in addition to electrical shocks and death or serious injury.

**■ Avoiding battery fires or explosions**

Observe the following precautions to prevent accidentally igniting the flammable gas that may be emitted from the battery:

- Make sure each jumper cable is connected to the correct terminal and that it is not unintentionally in contact with any other than the intended terminal.
- Do not allow the other end of the jumper cable connected to the “+” terminal to come into contact with any other parts or metal surfaces in the area, such as brackets or unpainted metal.
- Do not allow the + and - clamps of the jumper cables to come into contact with each other.
- Do not smoke, use matches, cigarette lighters or allow open flame near the battery.

**■ Battery precautions**

The battery contains poisonous and corrosive acidic electrolyte, while related parts contain lead and lead compounds. Observe the following precautions when handling the battery:

- When working with the battery, always wear safety glasses and take care not to allow any battery fluids (acid) to come into contact with skin, clothing or the vehicle body.
- Do not lean over the battery.
- In the event that battery fluid comes into contact with the skin or eyes, immediately wash the affected area with water and seek medical attention. Place a wet sponge or cloth over the affected area until medical attention can be received.
- Always wash your hands after handling the battery support, terminals, and other battery-related parts.
- Do not allow children near the battery.

**■ When replacing the battery**

- When the vent plug and indicator are close to the hold down clamp, the battery fluid (sulfuric acid) may leak.
- For information regarding battery replacement, contact your Toyota dealer.

 **NOTICE**

**■ When handling jumper cables**

When connecting the jumper cables, ensure that they do not become entangled in the cooling fan or engine drive belt.

**If your vehicle overheats**

**The following may indicate that your vehicle is overheating.**

- The needle of the engine coolant temperature gauge (→P.79) enters the red zone or a loss of engine power is experienced. (For example, the vehicle speed does not increase.)
- “Engine Coolant Temp High Stop in a Safe Place See Owner’s Manual” is shown on the multi-information display.
- Steam comes out from under the hood.

**Correction procedures**

- 1** Stop the vehicle in a safe place and turn off the air conditioning system, and then stop the engine.
- 2** If you see steam:  
Carefully lift the hood after the steam subsides.  
If you do not see steam:  
Carefully lift the hood.
- 3** After the engine has cooled down sufficiently, inspect the hoses and radiator core (radiator) for any leaks.

If a large amount of coolant leaks, immediately contact your Toyota

dealer.

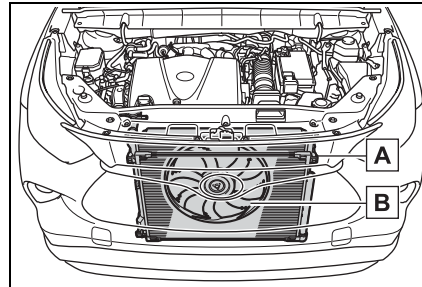

**A** Radiator

**B** Cooling fan

- 4** The coolant level is satisfactory if it is between the “FULL” and “LOW” lines on the reservoir.

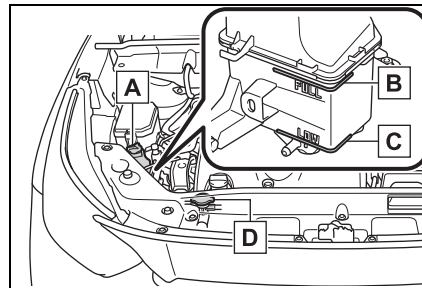

**A** Reservoir

**B** “FULL” line

**C** “LOW” line

**D** Radiator cap

- 5** Add coolant if necessary.  
Water can be used in an emer-

## 488 7-2. Steps to take in an emergency

gency if coolant is unavailable.

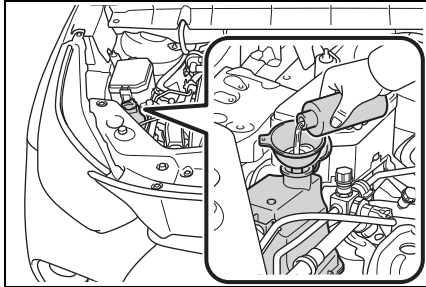

- 6 Start the engine and turn the air conditioning system on to check that the radiator cooling fan operates and to check for coolant leaks from the radiator or hoses.

The fan operates when the air conditioning system is turned on immediately after a cold start. Confirm that the fan is operating by checking the fan sound and air flow. If it is difficult to check these, turn the air conditioning system on and off repeatedly. (The fan may not operate in freezing temperatures.)

- 7 If the fan is not operating:  
Stop the engine immediately and contact your Toyota dealer.  
If the fan is operating:  
Have the vehicle inspected at the nearest Toyota dealer.
- 8 Check if "Engine Coolant Temp High Stop in a Safe Place See Owner's Manual" is shown on the multi-information display.

If the message does not disappear:  
Stop the engine and contact your Toyota dealer.

If the message is not displayed:  
Have the vehicle inspected at the nearest Toyota dealer.

### WARNING

#### ■ When inspecting under the hood of your vehicle

Observe the following precautions. Failure to do so may result in serious injury such as burns.

- If steam is seen coming from under the hood, do not open the hood until the steam has subsided. The engine compartment may be very hot.
- Keep hands and clothing (especially a tie, a scarf or a muffler) away from the fan and belts. Failure to do so may cause the hands or clothing to be caught, resulting in serious injury.
- Do not loosen the radiator cap and the coolant reservoir cap while the engine and radiator are hot. High temperature steam or coolant could spray out.

### NOTICE

#### ■ When adding engine coolant

Add coolant slowly after the engine has cooled down sufficiently. Adding cool coolant to a hot engine too quickly can cause damage to the engine.

#### ■ To prevent damage to the cooling system

Observe the following precautions:

- Avoid contaminating the coolant with foreign matter (such as sand or dust, etc.).
- Do not use any coolant additive.



**If the vehicle becomes stuck**

**Carry out the following procedures if the tires spin or the vehicle becomes stuck in mud, dirt or snow:**

**Recovering procedure**

- 1** Stop the engine. Shift the shift lever to P and set the parking brake.
- 2** Remove the mud, snow or sand from around the front wheels.
- 3** Place wood, stones or some other material under the front wheels to help provide traction.
- 4** Restart the engine.
- 5** Shift the shift lever to D or R and release the parking brake. Then, while exercising caution, depress the accelerator pedal.

**When it is difficult to free the vehicle**

Press  to turn off TRAC.

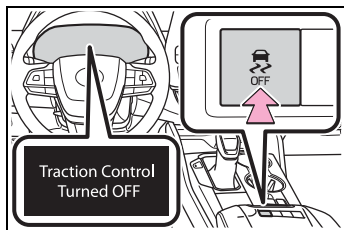

**WARNING**

**When attempting to free a stuck vehicle**

If you choose to push the vehicle back and forth to free it, make sure the surrounding area is clear to avoid striking other vehicles, objects or people. The vehicle may also lunge forward or lunge back suddenly as it becomes free. Use extreme caution.

**When shifting the shift lever**

Be careful not to shift the shift lever with the accelerator pedal depressed. This may lead to unexpected rapid acceleration of the vehicle that may cause an accident resulting in death or serious injury.

**NOTICE**

**To avoid damage to the transmission and other components**

- Avoid spinning the front wheels and depressing the accelerator pedal more than necessary.
- If the vehicle remains stuck even after these procedures are performed, the vehicle may require towing to be freed.



## Vehicle specifications

8

491

### 8-1. Specifications

Maintenance data (fuel, oil level, etc.) ..... 492

Fuel information ..... 503

Tire information ..... 505

### 8-2. Customization

Customizable features ..... 515

### 8-3. Initialization

Items to initialize ..... 527

8

Vehicle specifications

**Maintenance data (fuel, oil level, etc.)**

**Dimensions and weight**

Overall length	194.9 in. (4950 mm)	
Overall width	76 in. (1930 mm)	
Overall height <sup>*1</sup>	68.1 in. (1730 mm)	
Wheelbase	112.2 in. (2850 mm)	
Tread	Front	65.3 in. (1659 mm)
	Rear	65.4 in. (1662 mm)
Vehicle capacity weight (Occupants + luggage)	1225 lb. (555 kg) <sup>*2</sup> 1330 lb. (605 kg) <sup>*3,4</sup> 1390 lb. (630 kg) <sup>*3,5</sup>	
Trailer Weight Rating (Trailer weight + cargo weight)	5000 lb. (2200 kg)	

<sup>\*1</sup>: Unladen vehicle

<sup>\*2</sup>: For 7-seat models

<sup>\*3</sup>: For 8-seat models

<sup>\*4</sup>: For GSU75L-ARZGHA models<sup>\*6</sup>

<sup>\*5</sup>: Except for GSU75L-ARZGHA models<sup>\*6</sup>

<sup>\*6</sup>: The model code is indicated on the Certification Label. (→P.492)

**Seating capacity**

Seating capacity	7-seat models	8-seat models
	7 (Front 2, Rear 5)	8 (Front 2, Rear 6)

**Vehicle identification**

**Vehicle identification number**

The vehicle identification number (VIN) is the legal identifier for your vehicle. This is the pri-

mary identification number for your Toyota. It is used in registering the ownership of your vehicle.

- ▶ Top left of the instrument panel

The vehicle identification number is stamped.

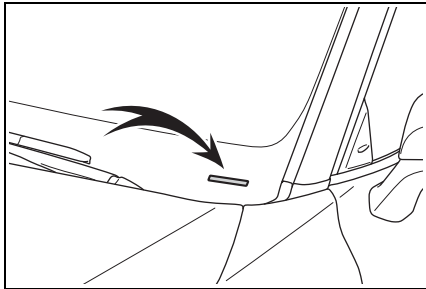

- ▶ Under the right-hand front seat

- 1 Remove the scuff plate.

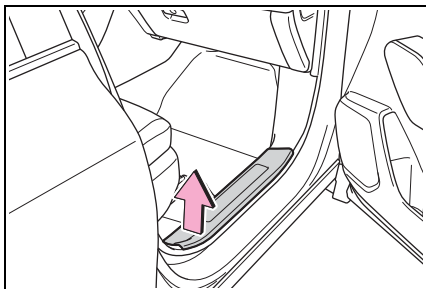

- 2 Remove the nut and trim.

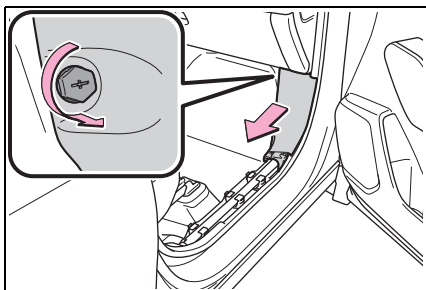

- 3 Turn back the carpet.

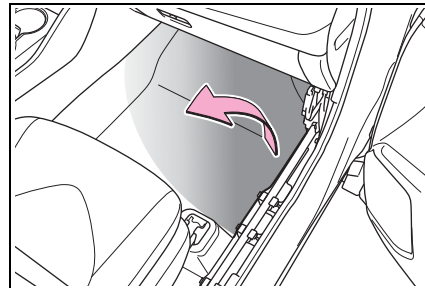

- 4 Remove the dash panel insulator pad.

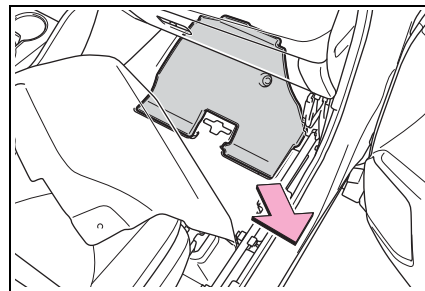

- 5 Turn back the floor panel insulator pad.

The vehicle identification number is stamped.

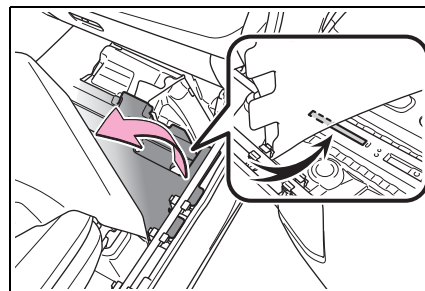

- 6 Return the floor panel insulator pad to its original position.

Insert the 2 ends of the floor panel insulator pad under the wire har-

ness.

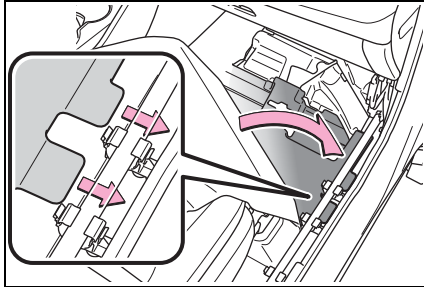

**7** Install the dash panel insulator pad.

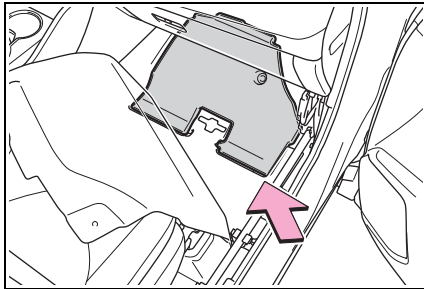

**8** Return the carpet to its original position.

Install the 2 holes of the carpet to the wire harness clamps.

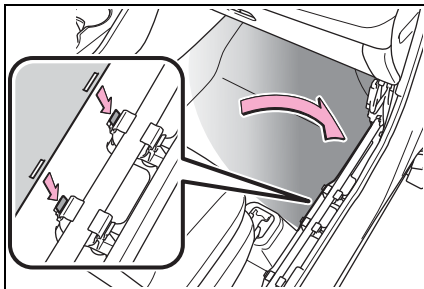

**9** Install the trim.

Align the clip, claw and bolt hole

and install the trim with the nut.

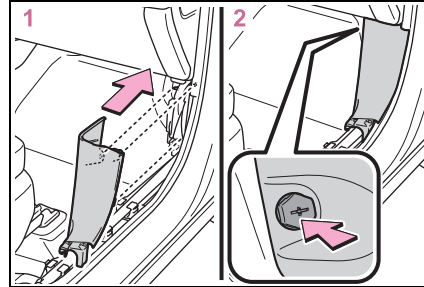

**10** Install the scuff plate.

Insert the 2 guides at the front of the scuff plate into the trim, align the 7 claws with the wire harness clamps, and install the scuff plate.

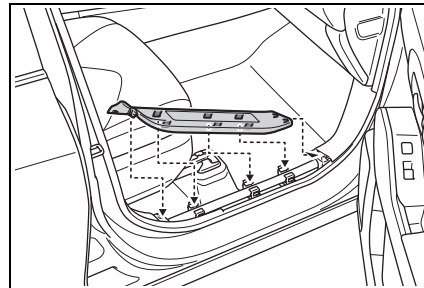

► Left-hand side center pillar

This number is also on the Certification Label.

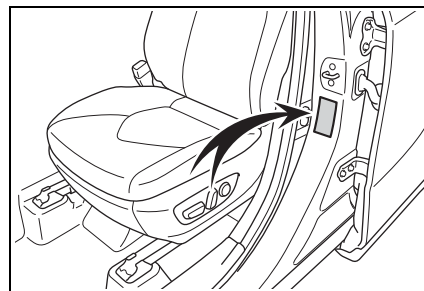

■ **Engine number**

The engine number is stamped on the engine block as shown.

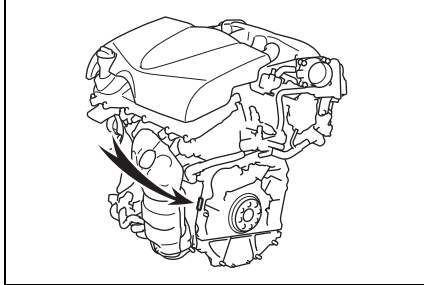

### Engine

Model	2GR-FKS
Type	6-cylinder V type, 4-cycle, gasoline
Bore and stroke	3.70 × 3.27 in. (94.0 × 83.0 mm)
Displacement	210.9 cu. in. (3456 cm <sup>3</sup> )
Valve clearance (engine cold)	Automatic adjustment
Drive belt tension	Automatic adjustment

### Fuel

Fuel type	Unleaded gasoline only
Octane Rating	87 (Research Octane Number 91) or higher
Fuel tank capacity (Reference)	17.9 gal. (68 L, 14.9 Imp. gal.)

### Lubrication system

#### ■ Oil capacity (Drain and refill—reference\*)

With filter	5.8 qt. (5.5 L, 4.8 Imp. qt.)
Without filter	5.6 qt. (5.3 L, 4.7 Imp. qt.)

\*: The engine oil capacity is a reference quantity to be used when

changing the engine oil. Warm up and turn off the engine, wait more than 5 minutes, and check the oil level on the dipstick.

#### ■ Engine oil selection

“Toyota Genuine Motor Oil” is used in your Toyota vehicle. Use Toyota approved “Toyota Genuine Motor Oil” or equivalent to

## 496 8-1. Specifications

satisfy the following grade and viscosity.

Oil grade: ILSAC GF-5 multi-grade engine oil

Recommended viscosity: SAE 0W-20

SAE 0W-20 is the best choice for good fuel economy and good starting in cold weather.

If SAE 0W-20 is not available, SAE 5W-20 oil may be used. However, it must be replaced with SAE 0W-20 at the next oil change.

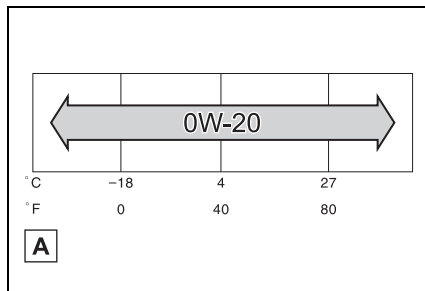

### **A** Outside temperature

Oil viscosity (0W-20 is explained here as an example):

- The 0W in 0W-20 indicates the characteristic of the oil which allows cold startability. Oils with a lower value before the W allow for easier starting of the engine in cold weather.
- The 20 in 0W-20 indicates the viscosity characteristic of the oil when the oil is at high temperature. An oil with a higher viscosity (one with a higher value) may be better suited if the vehicle is operated at high

speeds, or under extreme load conditions.

How to read oil container label:

The International Lubricant Specification Advisory Committee (ILSAC) Certification Mark is added to some oil containers to help you select the oil you should use.







**Cooling system**

Capacity	<ul style="list-style-type: none"> <li>▶ Vehicles with Stop &amp; Start system 12.9 qt. (12.2 L, 10.7 Imp. qt.)</li> <li>▶ Vehicles without Stop &amp; Start system 12.5 qt. (11.8 L, 10.4 Imp. qt.)</li> </ul>
Coolant type	<p>Use either of the following:</p> <ul style="list-style-type: none"> <li>• “Toyota Super Long Life Coolant”</li> <li>• Similar high-quality ethylene glycol-based non-silicate, non-amine, non-nitrite, and non-borate coolant with long-life hybrid organic acid technology</li> </ul> <p>Do not use plain water alone.</p>

**Ignition system (spark plug)**

Make	DENSO FK20HBR8
Gap	0.031 in. (0.8 mm)

 **NOTICE**

 **Iridium-tipped spark plugs**

Use only iridium-tipped spark plugs. Do not adjust the spark plug gap.

**Electrical system (battery)**

Open voltage at 68°F (20°C):	12.3 V or higher (Turn the engine switch off and turn on the high beam headlights for 30 seconds.)
Charging rates	5 A max.

**Automatic transmission**

Fluid capacity *	8.0 qt. (7.58 L, 6.7 Imp. qt.)
Fluid type	Toyota Genuine ATF WS

\*: The fluid capacity is a reference quantity.  
If replacement is necessary, contact your Toyota dealer.

 NOTICE
<p><b>■ Transmission fluid type</b></p> <p>Using transmission fluid other than the above type may cause abnormal noise or vibration, or damage the transmission of your vehicle.</p>

**Transfer (AWD models)**

Oil capacity*	0.41 qt. (0.39 L, 0.35 Imp. qt.)
Oil type and viscosity	Toyota Genuine Differential gear oil LX

\*: The fluid capacity is a reference quantity.  
If replacement is necessary, contact your Toyota dealer.

 NOTICE
<p><b>■ Transfer oil type precaution</b></p> <p>Using transfer oil other than the specified oil may cause abnormal noise or vibration, or damage the transfer of your vehicle.</p>

**Rear differential (AWD models)**

Oil capacity*	0.56 qt. (0.53 L, 0.47 Imp. qt.)
Oil type and viscosity	Toyota Genuine Differential gear oil LX

\*: The fluid capacity is a reference quantity.  
If replacement is necessary, contact your Toyota dealer.

 NOTICE
<p><b>■ Differential gear oil type precaution</b></p> <p>Using differential gear oil other than the specified oil may cause abnormal noise or vibration, or damage the differential gear of your vehicle.</p>

**Brakes**

Pedal clearance *	3.7 in. (94 mm) Min.
Pedal free play	0.04 — 0.24 in. (1 — 6 mm)
Brake pad wear limit	0.04 in. (1 mm)
Fluid type	SAE J1703 or FMVSS No. 116 DOT 3

\*: Minimum pedal clearance when depressed with a force of 67.4 lbf (300 N, 30.6 kgf) while the engine is running.

**Steering**

Free play	Less than 1.2 in. (30 mm)
-----------	---------------------------

**Tires and wheels**

► Type A

Tire size	235/65R18 106V, T165/90D18 107M (spare)
Tire inflation pressure (Recommended cold tire inflation pressure)	<p>► Front 36 psi (250 kPa, 2.5 kgf/cm<sup>2</sup> or bar)</p> <p>► Rear 36 psi (250 kPa, 2.5 kgf/cm<sup>2</sup> or bar)</p> <p>► Spare 60 psi (420 kPa, 4.2 kgf/cm<sup>2</sup> or bar)</p> <p>Driving at high speeds (above 100 mph [160 km/h]) (in countries where such speeds are permitted by law)</p> <p>Add 4 psi (30 kPa, 0.3 kgf/cm<sup>2</sup> or bar) to the front and rear tires. Never exceed the maximum cold tire inflation pressure indicated on the tire side-wall.</p>
Wheel size	18 × 8 J, 18 × 4T (spare)
Wheel nut torque	76 ft•lbf (103 N•m, 10.5 kgf•m)

**500**    **8-1. Specifications**

▶ Type B

Tire size	235/55R20 102V, T165/90D18 107M (spare)
Tire inflation pressure (Recommended cold tire inflation pressure)	<p>▶ Front 36 psi (250 kPa, 2.5 kgf/cm<sup>2</sup> or bar)</p> <p>▶ Rear 36 psi (250 kPa, 2.5 kgf/cm<sup>2</sup> or bar)</p> <p>▶ Spare 60 psi (420 kPa, 4.2 kgf/cm<sup>2</sup> or bar)</p> <p>Driving at high speeds (above 100 mph [160 km/h]) (in countries where such speeds are permitted by law)</p> <p>Add 4 psi (30 kPa, 0.3 kgf/cm<sup>2</sup> or bar) to the front and rear tires. Never exceed the maximum cold tire inflation pressure indicated on the tire side-wall.</p>
Wheel size	20 × 8 J, 18 × 4T (spare)
Wheel nut torque	76 ft•lbf (103 N•m, 10.5 kgf•m)

▶ Type C

Tire size	235/65R18 106V
Tire inflation pressure (Recommended cold tire inflation pressure)	<p>▶ Front 36 psi (250 kPa, 2.5 kgf/cm<sup>2</sup> or bar)</p> <p>▶ Rear 36 psi (250 kPa, 2.5 kgf/cm<sup>2</sup> or bar)</p> <p>▶ Spare 36 psi (250 kPa, 2.5 kgf/cm<sup>2</sup> or bar)</p> <p>Driving at high speeds (above 100 mph [160 km/h]) (in countries where such speeds are permitted by law)</p> <p>Add 4 psi (30 kPa, 0.3 kgf/cm<sup>2</sup> or bar) to the front and rear tires. Never exceed the maximum cold tire inflation pressure indicated on the tire side-wall.</p>
Wheel size	18 × 8 J
Wheel nut torque	76 ft•lbf (103 N•m, 10.5 kgf•m)

► Type D

Tire size	235/55R20 102V
Tire inflation pressure (Recommended cold tire inflation pressure)	<p>► Front 36 psi (250 kPa, 2.5 kgf/cm<sup>2</sup> or bar)</p> <p>► Rear 36 psi (250 kPa, 2.5 kgf/cm<sup>2</sup> or bar)</p> <p>► Spare 36 psi (250 kPa, 2.5 kgf/cm<sup>2</sup> or bar)</p> <p>Driving at high speeds (above 100 mph [160 km/h]) (in countries where such speeds are permitted by law)</p> <p>Add 4 psi (30 kPa, 0.3 kgf/cm<sup>2</sup> or bar) to the front and rear tires. Never exceed the maximum cold tire inflation pressure indicated on the tire side-wall.</p>
Wheel size	20 × 8 J
Wheel nut torque	76 ft•lbf (103 N•m, 10.5 kgf•m)

**Light bulbs**

	Light bulbs	Bulb No.	W	Type
Exterior	Front side marker lights	—	5	B
	Front turn signal lights	7444NA	28	A
	Rear turn signal lights	—	21	A
	Back-up lights	—	16	B
	License plate lights	—	5	B
	Parking lights	7444NA	8	A
Interior	Door courtesy lights	—	5	C
	Vanity lights	—	8	C
	Rear personal light	—	8	C
	Rear interior light	—	8	C

A: Wedge base bulbs (amber)

B: Wedge base bulbs (clear)

**502** 8-1. Specifications

---

C: Single end bulbs (clear)

**Fuel information**

**You must only use unleaded gasoline.**

**Select octane rating 87 (Research Octane Number 91) or higher. Use of unleaded gasoline with an octane rating lower than 87 may result in engine knocking. Persistent knocking can lead to engine damage.**

At minimum, the gasoline you use should meet the specifications of ASTM D4814 in the U.S.A.

#### ■ Gasoline quality

In very few cases, driveability problems may be caused by the brand of gasoline you are using. If driveability problems persist, try changing the brand of gasoline. If this does not correct the problem, consult your Toyota dealer.

#### ■ Recommendation of the use of gasoline containing detergent additives

- Toyota recommends the use of gasoline that contains detergent additives to avoid the build-up of engine deposits.
- All gasoline sold in the U.S.A. contains minimum detergent additives to clean and/or keep clean intake systems, per EPA's lowest additives concentration program.
- Toyota strongly recommends the use of Top Tier Detergent Gasoline. For more information on Top Tier Detergent Gasoline and a list of marketers, please go to the official website [www.toptiergas.com](http://www.toptiergas.com).

#### ■ Recommendation of the use of low emissions gasoline

Gasolines containing oxygenates such as ethers and ethanol, as well as reformulated gasolines, are available in some cities. These fuels are typically acceptable for use, providing they meet other fuel requirements.

Toyota recommends these fuels, since the formulations allow for reduced vehicle emissions.

#### ■ Non-recommendation of the use of blended gasoline

- Use only gasoline containing up to 15% ethanol.  
DO NOT use any flex-fuel or gasoline that could contain more than 15% ethanol, including from any pump labeled E30 (30% ethanol [A]), E50 (50% ethanol [B]), E85 (85% ethanol [C]) (which are only some examples of fuel containing more than 15% ethanol).

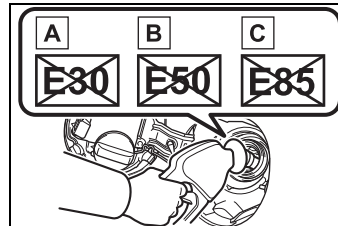

- If you use gasohol in your vehicle, be sure that it has an octane rating no lower than 87.
- Toyota does not recommend the use of gasoline containing methanol.

#### ■ Non-recommendation of the use of gasoline containing MMT

Some gasoline contains an octane enhancing additive called MMT (Methylcyclopentadienyl Manganese Tricarbonyl).

Toyota does not recommend the use of gasoline that contains MMT. If fuel containing MMT is used, your emission control system may be

adversely affected.

The malfunction indicator lamp on the instrument cluster may come on. If this happens, contact your Toyota dealer for service.



**NOTICE**

■ **Notice on fuel quality**

- Do not use improper fuels. If improper fuels are used, the engine will be damaged.
- Do not use leaded gasoline. Leaded gasoline can cause damage to your vehicle's three-way catalytic converters causing the emission control system to malfunction.
- Do not use gasohol other than the type previously stated. Other gasohol may cause fuel system damage or vehicle performance problems.
- Using unleaded gasoline with an octane number or rating lower than the level previously stated will cause persistent heavy knocking. At worst, this will lead to engine damage.

■ **When refueling with gasohol**

Take care not to spill gasohol. It can damage your vehicle's paint.

■ **Fuel-related poor driveability**

If poor driveability (poor hot starting, vaporization, engine knocking, etc.) is encountered after using a different type of fuel, discontinue the use of that type of fuel.



**Tire information**

**Typical tire symbols**

► Full-size tire

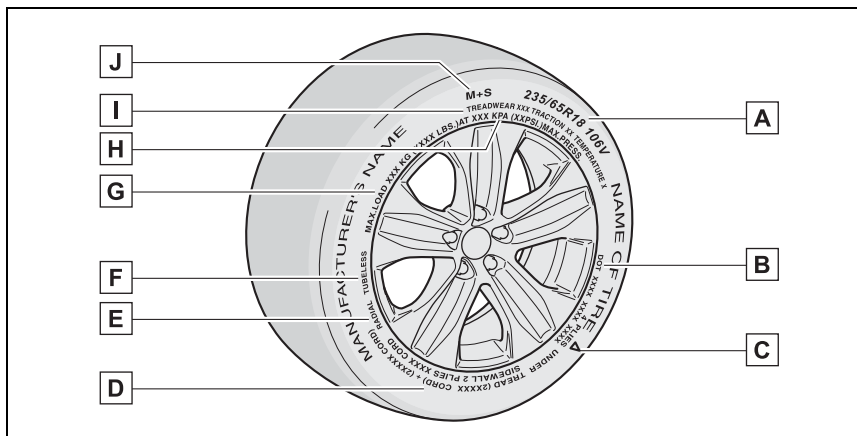

► Compact spare tire

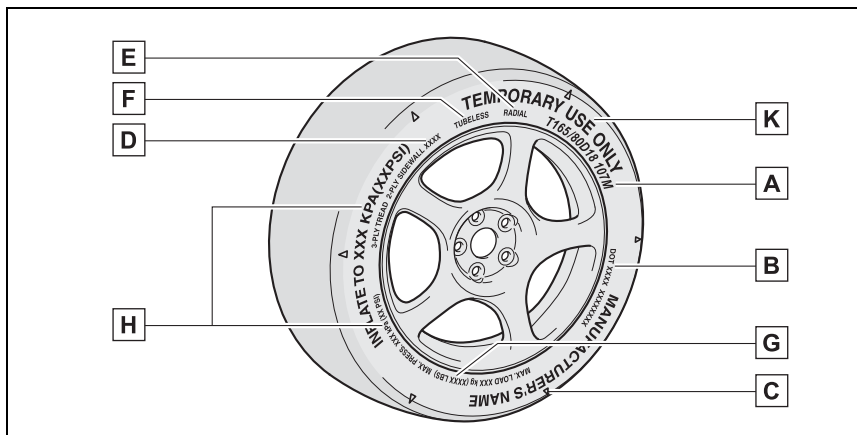

- A** Tire size (→P.507)
- B** DOT and Tire Identification Number (TIN) (→P.506)
- C** Location of treadwear indicators (→P.411)
- D** Tire ply composition and materials  
Plies are layers of rubber-coated parallel cords. Cords are the strands which form the plies in a tire.
- E** Radial tires or bias-ply tires

**506 8-1. Specifications**

A radial tire has "RADIAL" on the sidewall. A tire not marked "RADIAL" is a bias-ply tire.

**F** TUBELESS or TUBE TYPE

A tubeless tire does not have a tube and air is directly put into the tire. A tube type tire has a tube inside the tire and the tube maintains the air pressure.

**G** Load limit at maximum cold tire inflation pressure (→P.412)

**H** Maximum cold tire inflation pressure (→P.499)

This means the pressure to which a tire may be inflated.

**I** Uniform tire quality grading

For details, see "Uniform Tire Quality Grading" that follows.

**J** Summer tires or all season tires (→P.412)

An all season tire has "M+S" on the sidewall. A tire not marked "M+S" is a summer tire.

**K** "TEMPORARY USE ONLY"

A compact spare tire is identified by the phrase "TEMPORARY USE ONLY" molded on its sidewall. This tire is designed for temporary emergency use only.

**Typical DOT and Tire Identification Number (TIN)**

► Type A

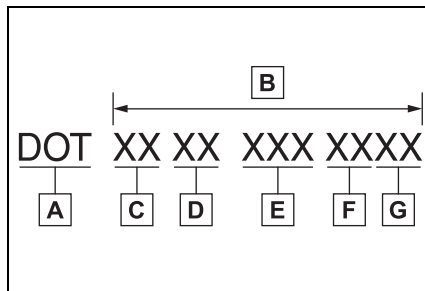

- A** DOT symbol\*
- B** Tire Identification Number (TIN)
- C** Tire manufacturer's identification mark

**D** Tire size code

**E** Manufacturer's optional tire type code (3 or 4 letters)

**F** Manufacturing week

**G** Manufacturing year

\*: The DOT symbol certifies that the tire conforms to applicable Federal Motor Vehicle Safety Standards.

► Type B

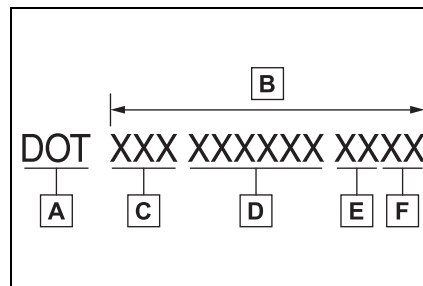

- A** DOT symbol\*
- B** Tire Identification Number (TIN)
- C** Tire manufacturer's identification mark
- D** Manufacturer's code
- E** Manufacturing week
- F** Manufacturing year

\*: The DOT symbol certifies that the tire conforms to applicable Federal Motor Vehicle Safety Standards.

**Tire size**

■ **Typical tire size information**

The illustration indicates typical tire size.

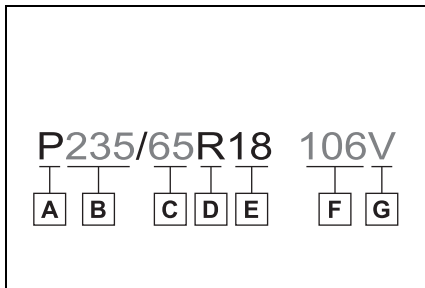

- A** Tire use (P = Passenger car, T = Temporary use)
- B** Section width (millimeters)
- C** Aspect ratio (tire height to section width)
- D** Tire construction code (R = Radial, D = Diagonal)
- E** Wheel diameter (inches)
- F** Load index (2 digits or 3 digits)

- G** Speed symbol (alphabet with one letter)

■ **Tire dimensions**

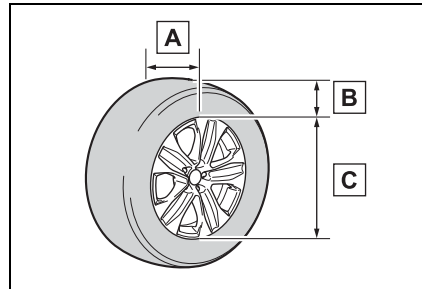

- A** Section width
- B** Tire height
- C** Wheel diameter

**Tire section names**

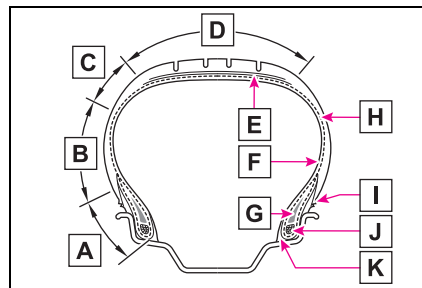

- A** Bead
- B** Sidewall
- C** Shoulder
- D** Tread
- E** Belt
- F** Inner liner
- G** Reinforcing rubber
- H** Carcass
- I** Rim lines
- J** Bead wires

**K** Chafer

### Uniform Tire Quality Grading

This information has been prepared in accordance with regulations issued by the National Highway Traffic Safety Administration of the U.S. Department of Transportation.

It provides the purchasers and/or prospective purchasers of Toyota vehicles with information on uniform tire quality grading.

Your Toyota dealer will help answer any questions you may have as you read this information.

#### ■ DOT quality grades

All passenger vehicle tires must conform to Federal Safety Requirements in addition to these grades. Quality grades can be found where applicable on the tire sidewall between tread shoulder and maximum section width.

For example: Treadwear 200 Traction AA Temperature A

#### ■ Treadwear

The treadwear grade is a comparative rating based on the wear rate of the tire when tested under controlled conditions on a specified government test course.

For example, a tire graded 150

would wear one and a half (1 - 1/2) times as well on the government course as a tire graded 100.

The relative performance of tires depends upon the actual conditions of their use. Performance may differ significantly from the norm due to variations in driving habits, service practices and differences in road characteristics and climate.

#### ■ Traction AA, A, B, C

The traction grades, from highest to lowest, are AA, A, B and C, and they represent the tire's ability to stop on wet pavement as measured under controlled conditions on specified government test surfaces of asphalt and concrete.

A tire marked C may have poor traction performance.

Warning: The traction grade assigned to this tire is based on braking (straight ahead) traction tests and does not include cornering (turning) traction.

#### ■ Temperature A, B, C

The temperature grades are A (the highest), B, and C, representing the tire's resistance to the generation of heat and its ability to dissipate heat when tested under controlled conditions on a specified indoor laboratory test wheel.

Sustained high temperature can cause the material of the tire to degenerate and reduce tire life, and excessive temperature can lead to sudden tire failure.

Grade C corresponds to a level of performance which all passenger car tires must meet under the Federal Motor Vehicle Safety Standard No. 109.

Grades B and A represent higher levels of performance on the laboratory test wheel than the minimum required by law.

Warning: The temperature grades of a tire assume that it is properly inflated and not overloaded.

Excessive speed, underinflation, or excessive loading, either separately or in combination, can cause heat buildup and possible tire failure.

**Glossary of tire terminology**

Tire related term	Meaning
Cold tire inflation pressure	Tire pressure when the vehicle has been parked for three hours or more, or has not been driven more than 1 mile or 1.5 km under that condition
Maximum inflation pressure	The maximum cold inflated pressure to which a tire may be inflated, shown on the sidewall of the tire
Recommended inflation pressure	Cold tire inflation pressure recommended by a manufacturer
Accessory weight	The combined weight (in excess of those standard items which may be replaced) of automatic transmission, power steering, power brakes, power windows, power seats, radio and heater, to the extent that these items are available as factory-installed equipment (whether installed or not)
Curb weight	The weight of a motor vehicle with standard equipment, including the maximum capacity of fuel, oil and coolant, and if so equipped, air conditioning and additional weight optional engine

**510**    **8-1. Specifications**

Tire related term	Meaning
Maximum loaded vehicle weight	The sum of: (a) Curb weight (b) Accessory weight (c) Vehicle capacity weight (d) Production options weight
Normal occupant weight	150 lb. (68 kg) times the number of occupants specified in the second column of Table 1* that follows
Occupant distribution	Distribution of occupants in a vehicle as specified in the third column of Table 1* below
Production options weight	The combined weight of installed regular production options weighing over 5 lb. (2.3 kg) in excess of the standard items which they replace, not previously considered in curb weight or accessory weight, including heavy duty brakes, ride levelers, roof rack, heavy duty battery, and special trim
Rim	A metal support for a tire or a tire and tube assembly upon which the tire beads are seated
Rim diameter (Wheel diameter)	Nominal diameter of the bead seat
Rim size designation	Rim diameter and width
Rim type designation	The industry manufacturer's designation for a rim by style or code
Rim width	Nominal distance between rim flanges
Vehicle capacity weight (Total load capacity)	The rated cargo and luggage load plus 150 lb. (68 kg) times the vehicle's designated seating capacity
Vehicle maximum load on the tire	The load on an individual tire that is determined by distributing to each axle its share of the maximum loaded vehicle weight, and dividing by two

Tire related term	Meaning
Vehicle normal load on the tire	The load on an individual tire that is determined by distributing to each axle its share of curb weight, accessory weight, and normal occupant weight (distributed in accordance with Table 1* below), and dividing by two
Weather side	The surface area of the rim not covered by the inflated tire
Bead	The part of the tire that is made of steel wires, wrapped or reinforced by ply cords and that is shaped to fit the rim
Bead separation	A breakdown of the bond between components in the bead
Bias ply tire	A pneumatic tire in which the ply cords that extend to the beads are laid at alternate angles substantially less than 90 degrees to the centerline of the tread
Carcass	The tire structure, except tread and sidewall rubber which, when inflated, bears the load
Chunking	The breaking away of pieces of the tread or sidewall
Cord	The strands forming the plies in the tire
Cord separation	The parting of cords from adjacent rubber compounds
Cracking	Any parting within the tread, sidewall, or innerliner of the tire extending to cord material
CT	A pneumatic tire with an inverted flange tire and rim system in which the rim is designed with rim flanges pointed radially inward and the tire is designed to fit on the underside of the rim in a manner that encloses the rim flanges inside the air cavity of the tire

**512** 8-1. Specifications

Tire related term	Meaning
Extra load tire	A tire designed to operate at higher loads and at higher inflation pressures than the corresponding standard tire
Groove	The space between two adjacent tread ribs
Innerliner	The layer(s) forming the inside surface of a tubeless tire that contains the inflating medium within the tire
Innerliner separation	The parting of the innerliner from cord material in the carcass
Intended outboard sidewall	(a) The sidewall that contains a whitewall, bears white lettering, or bears manufacturer, brand, and/or model name molding that is higher or deeper than the same molding on the other sidewall of the tire, or (b) The outward facing sidewall of an asymmetrical tire that has a particular side that must always face outward when mounted on a vehicle
Light truck (LT) tire	A tire designated by its manufacturer as primarily intended for use on lightweight trucks or multipurpose passenger vehicles
Load rating	The maximum load that a tire is rated to carry for a given inflation pressure
Maximum load rating	The load rating for a tire at the maximum permissible inflation pressure for that tire
Maximum permissible inflation pressure	The maximum cold inflation pressure to which a tire may be inflated
Measuring rim	The rim on which a tire is fitted for physical dimension requirements
Open splice	Any parting at any junction of tread, sidewall, or innerliner that extends to cord material
Outer diameter	The overall diameter of an inflated new tire
Overall width	The linear distance between the exteriors of the sidewalls of an inflated tire, including elevations due to labeling, decorations, or protective bands or ribs



Tire related term	Meaning
Passenger car tire	A tire intended for use on passenger cars, multipurpose passenger vehicles, and trucks, that have a gross vehicle weight rating (GVWR) of 10,000 lb. or less.
Ply	A layer of rubber-coated parallel cords
Ply separation	A parting of rubber compound between adjacent plies
Pneumatic tire	A mechanical device made of rubber, chemicals, fabric and steel or other materials, that, when mounted on an automotive wheel, provides the traction and contains the gas or fluid that sustains the load
Radial ply tire	A pneumatic tire in which the ply cords that extend to the beads are laid at substantially 90 degrees to the centerline of the tread
Reinforced tire	A tire designed to operate at higher loads and at higher inflation pressures than the corresponding standard tire
Section width	The linear distance between the exteriors of the sidewalls of an inflated tire, excluding elevations due to labeling, decoration, or protective bands
Sidewall	That portion of a tire between the tread and bead
Sidewall separation	The parting of the rubber compound from the cord material in the sidewall
Snow tire	A tire that attains a traction index equal to or greater than 110, compared to the ASTM E-1136 Standard Reference Test Tire, when using the snow traction test as described in ASTM F-1805-00, Standard Test Method for Single Wheel Driving Traction in a Straight Line on Snow-and Ice-Covered Surfaces, and which is marked with an Alpine Symbol (  ) on at least one sidewall

**514** 8-1. Specifications

Tire related term	Meaning
Test rim	The rim on which a tire is fitted for testing, and may be any rim listed as appropriate for use with that tire
Tread	That portion of a tire that comes into contact with the road
Tread rib	A tread section running circumferentially around a tire
Tread separation	Pulling away of the tread from the tire carcass
Treadwear indicators (TWI)	The projections within the principal grooves designed to give a visual indication of the degrees of wear of the tread
Wheel-holding fixture	The fixture used to hold the wheel and tire assembly securely during testing

\*: Table 1 -Occupant loading and distribution for vehicle normal load for various designated seating capacities

Designated seating capacity, Number of occupants	Vehicle normal load, Number of occupants	Occupant distribution in a normally loaded vehicle
2 through 4	2	2 in front
5 through 10	3	2 in front, 1 in second seat
11 through 15	5	2 in front, 1 in second seat, 1 in third seat, 1 in fourth seat
16 through 20	7	2 in front, 2 in second seat, 2 in third seat, 1 in fourth seat

### Customizable features

**Your vehicle includes a variety of electronic features that can be personalized to suit your preferences. The settings of these features can be changed using the multi-information display, the navigation/multimedia system, or at your Toyota dealer.**



### Customizing vehicle features

#### ■ Changing by using the navigation/multimedia system

- 1 Press the "MENU" button.
- 2 Select "Setup" on the "Menu" screen.
- 3 Select "General" or "Vehicle" on the "Setup" screen.



Various setting can be changed. Refer to the list of settings that can be changed for details.

#### ■ Changing by using the meter control switches

- ▶ 4.2-inch display
- 1 Press < or > of the meter control switch to select .
  - 2 Press ^ or v of the meter control switch to select the desired item to be customized.
  - 3 Press or press and hold .

The available settings will differ depending on if  is pressed or pressed and held. Follow the instructions on the display.

#### ▶ 7-inch display

- 1 Press ^ or v of the meter control switch to select .
- 2 Press < or > of the meter control switch to select the desired item to be customized.
- 3 Press or press and hold .

The available settings will differ depending on if  is pressed or pressed and held. Follow the instructions on the display.

#### ■ When customizing using the navigation/multimedia system

Stop the vehicle in a safe place, apply the parking brake, and shift the shift lever to P. Also, to prevent battery discharge, leave the engine running while customizing the features.

#### WARNING

##### ■ During customization

As the engine needs to be running during customization, ensure that the vehicle is parked in a place with adequate ventilation. In a closed area such as a garage, exhaust gases including harmful carbon monoxide (CO) may collect and enter the vehicle. This may lead to death or a serious health hazard.

 NOTICE
<p><b>■ During customization</b> To prevent battery discharge, ensure that the engine is running while customizing features.</p>

### Customizable Features

Some function settings are changed simultaneously with other functions being customized. Contact your Toyota dealer for further details.

- A** Settings that can be changed using the navigation/multimedia system screen
- B** Settings that can be changed using the meter control switches
- C** Settings that can be changed by your Toyota dealer

Definition of symbols: O = Available, — = Not available

**■ Gauges, meters and multi-information display (→P.74, 79, 82, 91)**

Function <sup>*1</sup>	Default setting	Customized setting	<b>A</b>	<b>B</b>	<b>C</b>
Language	English	French	O	O	—
		Spanish			
Units <sup>*2</sup>	miles (MPG)	km (km/L)			
		km (L/100 km)	O	O	—
		miles (MPG Imperial)			
Eco Driving Indicator Light	On	Off	—	O	—
Fuel economy display <sup>*3</sup>	Total average (Average fuel consumption [after reset])	Trip average (Average fuel consumption [after start])			
		Tank average (Average fuel consumption [after refuel])	—	O	—

Function <sup>*1</sup>	Default setting	Customized setting	A	B	C
Audio system linked display <sup>*3</sup>	On	Off	—	○	—
AWD system display <sup>*3, 4</sup>	On	Off	—	○	—
Drive information type <sup>*3</sup>	After start	After reset	—	○	—
Drive information items (First item) <sup>*3</sup>	Distance	Average vehicle speed	—	○	—
		Elapsed time			
Drive information items (Second item) <sup>*3</sup>	Elapsed time	Average vehicle speed	—	○	—
		Distance			
Speedometer display <sup>*5</sup>	On	Off	—	○	—
Gadget content <sup>*5</sup>	Off	Average vehicle speed	—	○	—
		Distance			
		Elapsed time			
Fuel economy type <sup>*5</sup>	Trip (after start) <sup>*6</sup>	Total (after reset)	—	○	—
		Tank (after refuel) <sup>*7</sup>			
Pop-up display	On	Off	—	○	—
Rear seat reminder function	On	Off	—	○	—
Suggestion function	On	On (when the vehicle is stopped)	○	—	○
		Off	—	—	—

<sup>\*1</sup>: For details about each function: →P.89, 99

<sup>\*2</sup>: The default setting varies according to country.

<sup>\*3</sup>: 4.2-inch display

<sup>\*4</sup>: AWD models

<sup>\*5</sup>: 7-inch display

<sup>\*6</sup>: Selecting this item will only change the gadget.

<sup>\*7</sup>: Selecting this item will turn the display of the gadget off.

■ **Head-up Display\* (→P.101)**

Function	Default setting	Customized setting	A	B	C
Head-up display	On	Off	—	O	—
Gauge information	Tachometer	Eco Driving Indicator	—	O	—
		No content			
Route guidance to destination/street name	On	Off	—	O	—
Driving support system display	On	Off	—	O	—
Compass	On	Off	—	O	—
Audio system operation status	On	Off	—	O	—

\*: If equipped

■ **Door lock (→P.115, 481)**

Function	Default setting	Customized setting	A	B	C
Unlocking using a mechanical key	Driver's door unlocked in one step, all doors unlocked in two step	All doors unlocked in one step	—	—	O
Automatic door locking function	Shift position linked door locking operation	Off			
		Speed linked door locking operation	O	—	O
Automatic door unlocking function	Shift position linked door unlocking operation	Off			
		Driver's door linked door unlocking operation	O	—	O

■ **Smart key system and wireless remote control (→P.115, 131)**

Function	Default setting	Customized setting	A	B	C
Operation buzzer volume	5	Off	○	—	○
		1 to 7			
Operation signal (emergency flashers)	On	Off	○	—	○
Time elapsed before automatic door lock function is activated if door is not opened after being unlocked	60 seconds	Off	○	—	○
		30 seconds			
		120 seconds			
Open door reminder buzzer (when locking the vehicle)	On	Off	—	—	○

■ **Smart key system (→P.115, 131)**

Function	Default setting	Customized setting	A	B	C
Smart key system	On	Off	—	—	○
Smart door unlocking	Driver's door	All the doors	○	—	○
Number of consecutive door lock operations	2 times	As many as desired	—	—	○
Time elapsed before unlocking all the door when gripping and holding the driver's door handle*	2 seconds	Off	—	—	○
		1.5 seconds			
		2.5 seconds			

\* : This setting can be changed when the smart door unlocking setting is set to driver's door.

■ Wireless remote control (→P.113, 115, 119)

Function	Default setting	Customized setting	A	B	C
Wireless remote control	On	Off	—	—	○
Unlocking operation	Driver's door unlocked in one step, all doors unlocked in two step	All doors unlocked in one step	○	—	○
Theft deterrent panic mode	On	Off	—	—	○
Locking operation when door opened	On	Off	○	—	○

■ Power back door<sup>\*1</sup> (→P.119)

Function	Default setting	Customized setting	A	B	C
Power back door	On	Off	—	○	—
Kick sensor <sup>*1</sup>	On	Off	—	○	—
Power back door opening position	5	1 to 4	—	○	—
		User setting <sup>*2</sup>			
Buzzer volume	Level 3	Level 1	—	○	—
		Level 2			
Opening/closing of the back door using the power back door switch on the instrument panel	Press and hold	One short press	—	—	○
Opening/closing of the power back door using the  switch of the wireless remote control	Press and hold	One short press	—	—	○
		Push twice			
		Off			



Function	Default setting	Customized setting	A	B	C
Operation buzzer while the back door is operating <sup>*3</sup>	Off	On	—	—	O
Power back door open operation when the back door opener switch is pressed	On	Off	—	—	O

\*1: If equipped

\*2: The open position is set by the power back door switch. (→P.88, 98)

\*3: The operation buzzer that sounds when the back door begins to operate cannot be turned off.

■ **Driving position memory** \* (→P.144)

Function	Default setting	Customized setting	A	B	C
Selecting doors linked to the memory recall function	Driver's door	All doors	—	—	O

\*: If equipped

■ **Power windows and moon roof** \* (→P.164, 167)

Function	Default setting	Customized setting	A	B	C
Mechanical key linked operation	Off	On	—	—	O
Wireless remote control linked operation	Off	On (open only)	—	—	O
Wireless remote control linked operation signal (buzzer)	On	Off	—	—	O

\*: If equipped

■ Moon roof\* (→P.167)

Function	Default setting	Customized setting	A	B	C
Linked operation of components when mechanical key is used (open only)	Slide only	Tilt only	—	—	O
Linked operation of components when wireless remote control is used	Slide only	Tilt only	—	—	O

\*: If equipped

■ Automatic light control system (→P.214)

Function	Default setting	Customized setting	A	B	C
Light sensor sensitivity	Standard	-2 to 2	O	—	O
Time elapsed before headlights automatically turn off after doors are closed	30 seconds	Off	O	—	O
		60 seconds			
		90 seconds			
Windshield wiper linked headlight illumination	On	Off	—	—	O

■ Lights (→P.214)

Function	Default setting	Customized setting	A	B	C
Daytime running lights	On	Off* <sup>1</sup>	O	—	O
Welcome lighting	On	Off	—	—	O
AFS (Adaptive Front-lighting System)* <sup>2</sup>	On	Off	—	—	O

\*<sup>1</sup>: Except for Canada

\*<sup>2</sup>: If equipped

■ **Rear window wiper (→P.223)**

Function	Default setting	Customized setting	A	B	C
Back door opening linked rear window wiper stop function	Off	On	—	—	○
Washer linked rear window wiper operation	On	Off	—	—	○
Shift position linked rear window wiper operation (→P.224)	Only once	Off	—	—	○
		Continuous			

■ **PCS (Pre-Collision System) (→P.233)**

Function	Default setting	Customized setting	A	B	C
PCS (Pre-Collision System)	On	Off	—	○	—
Adjust alert timing	Middle	Early	—	○	—
		Late			

■ **LTA (Lane Tracing Assist) (→P.241)**

Function	Default setting	Customized setting	A	B	C
Lane centering function	On	Off	—	○	—
Steering assist function	On	Off	—	○	—
Alert sensitivity	High	Standard	—	○	—
Vehicle sway warning function	On	Off	—	○	—
Vehicle sway warning sensitivity	Standard	High	—	○	—
		Low			

■ **RSA (Road Sign Assist)\* (→P.251)**

Function	Default setting	Customized setting	A	B	C
RSA (Road Sign Assist)	On	Off	—	○	—
Excess speed notification method	Display only	No notification	—	○	—
		Display and buzzer			

**524** 8-2. Customization

Function	Default setting	Customized setting	A	B	C
Excess speed notification level	1 mph (2 km/h)	3 mph (5 km/h)	—	O	—
		5 mph (10 km/h)	—	O	—
Other notifications method (no-entry notification)	Display only	No notification	—	O	—
		Display and buzzer	—	O	—

\*: If equipped

■ **Stop & Start system\*** (→P.264)

Function	Default setting	Customized setting	A	B	C
Change the Stop & Start system duration when the A/C is on	Standard	Extended	—	O	—

\*: If equipped

■ **BSM (Blind Spot Monitor)\*** (→P.270)

Function	Default setting	Customized setting	A	B	C
BSM (Blind Spot Monitor)	On	Off	—	O	—
Outside rear view mirror indicator brightness	Bright	Dim	—	O	—
Alert timing for presence of approaching vehicle (sensitivity)	Intermediate	Early	—	O	—
		Late			
		Only when vehicle detected in blind spot			

\*: If equipped

■ **Intuitive parking assist\*** (→P.276)

Function	Default setting	Customized setting	A	B	C
Intuitive parking assist	On	Off	—	O	—
Buzzer volume	Level 2	Level 1	—	O	—
		Level 3			

\*: If equipped

■ **RCTA (Rear cross traffic alert) function\*** (→P.284)

Function	Default setting	Customized setting	A	B	C
RCTA (Rear cross traffic alert) function	On	Off	—	O	—
Buzzer volume	Level 2	Level 1	—	O	—
		Level 3			

\*: If equipped

■ **PKSB (Parking Support Brake)\*** (→P.289)

Function	Default setting	Customized setting	A	B	C
PKSB (Parking Support Brake) function	On	Off	—	O	—

\*: If equipped

■ **Front automatic air conditioning system\*** (→P.333)

Function	Default setting	Customized setting	A	B	C
A/C auto switch operation	On	Off	O	—	O

\*: If equipped

■ **Illumination** (→P.355)

Function	Default setting	Customized setting	A	B	C
Time elapsed before the interior lights turn off	15 seconds	Off	O	—	O
		7.5 seconds			
		30 seconds			
Operation after the engine switch is turned off	On	Off	—	—	O
Operation when the doors are unlocked	On	Off	—	—	O
Operation when you approach the vehicle with the electronic key on your person	On	Off	—	—	O

**526** 8-2. Customization

Function	Default setting	Customized setting	A	B	C
Instrument panel ornament light* and door trim ornament lights*	On	Off	—	—	O
Time elapsed before the outer foot lights* turn off	15 seconds	Off	O	—	O
		7.5 seconds			
		30 seconds			
Operation of the outer foot lights* when you approach the vehicle with the electronic key on your person	On	Off	—	—	O
Operation of the outer foot lights* when the doors are unlocked with the power door lock switch	On	Off	—	—	O

\* : If equipped

■ **Vehicle customization**

- When the smart key system is off, smart door unlocking cannot be customized.
- When the doors remain closed after unlocking the doors and the timer activated automatic door lock function activates, signals will be generated in accordance with the operation buzzer volume and operational signal (emergency flashers) function settings.

**Items to initialize**

The following items must be initialized for normal system operation after such cases as the battery being reconnected, or maintenance being performed on the vehicle:

**List of items to initialize**

Item	When to initialize	Reference
Power back door*	<ul style="list-style-type: none"> <li>• After reconnecting or changing the battery</li> </ul>	P.126
Intuitive parking assist*	<ul style="list-style-type: none"> <li>• After reconnecting or changing the battery</li> </ul>	P.279
PKSB (Parking Support Brake)*	<ul style="list-style-type: none"> <li>• After reconnecting or changing the battery</li> </ul>	P.295
Message indicating maintenance is required (U.S.A. only)	<ul style="list-style-type: none"> <li>• After the maintenance is performed</li> </ul>	P.395
Oil maintenance	<ul style="list-style-type: none"> <li>• After the maintenance is performed</li> </ul>	P.406
Tire pressure warning system	<ul style="list-style-type: none"> <li>• When the tire inflation pressure is changed such as when changing traveling speed</li> <li>• When the tire inflation pressure is changed such as when the tire size is changed</li> <li>• When rotating the tires</li> </ul>	P.417

\*: If equipped





**9-1. For owners**

- Reporting safety defects for U.S. owners..... **530**
- Seat belt instructions for Canadian owners (in French)..... **530**
- SRS airbag instructions for Canadian owners (in French)..... **532**
- Headlight aim instructions for Canadian owners (in French)..... **539**

### Reporting safety defects for U.S. owners

If you believe that your vehicle has a defect which could cause a crash or could cause injury or death, you should immediately inform the National Highway Traffic Safety Administration (NHTSA) in addition to notifying Toyota Motor Sales, U.S.A., Inc. (Toll-free: 1-800-331-4331).

If NHTSA receives similar complaints, it may open an investigation, and if it finds that a safety defect exists in a group of vehicles, it may order a recall and remedy campaign. However, NHTSA cannot become involved in individual problems between you, your dealer, or Toyota Motor Sales, U.S.A., Inc.

To contact NHTSA, you may call the Vehicle Safety Hotline toll-free at 1-888-327-4236 (TTY: 1-800-424-9153); go to <http://www.safercar.gov>; or write to: Administrator, NHTSA, 1200 New Jersey Ave, S.E., Washington, DC 20590. You can also obtain other information about motor vehicle safety from <http://www.safercar.gov>.

### Seat belt instructions for Canadian owners (in French)

The following is a French explanation of seat belt instructions extracted from the seat belt section in this manual.

See the seat belt section for more detailed seat belt instructions in English.

### Utilisation correcte des ceintures de sécurité

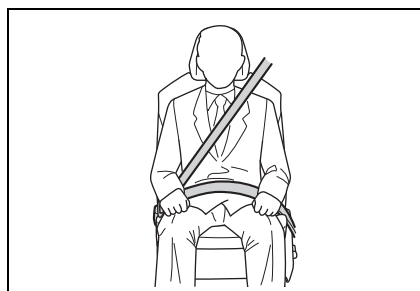

- Déroulez la sangle diagonale de telle sorte qu'elle passe bien sur l'épaule, sans pour autant être en contact avec le cou ou glisser de l'épaule.
- Placez la sangle abdominale le plus bas possible sur les hanches.
- Réglez la position du dossier de siège. Asseyez-vous le dos droit et calez-vous bien dans le siège.
- Ne vrillez pas la ceinture de

sécurité.

### Entretien et soin

#### ■ Traitement des ceintures de sécurité

Nettoyez avec un chiffon ou une éponge humidifiés avec de l'eau savonneuse tiède. Vérifiez régulièrement que les ceintures ne sont pas usées, effilochées ou entaillées excessivement.

#### **WARNING**

##### ■ Détérioration et usure des ceintures de sécurité

Inspectez le système de ceintures de sécurité régulièrement. Contrôlez l'absence de coupures, d'effilochages et de pièces desserrées. N'utilisez pas une ceinture de sécurité endommagée avant qu'elle ne soit remplacée. Une ceinture de sécurité endommagée ne permet pas de protéger un occupant de blessures graves ou mortelles.

## SRS airbag instructions for Canadian owners (in French)

The following is a French explanation of SRS airbag instructions extracted from the SRS airbag section in this manual.

See the SRS airbag section for more detailed SRS airbag instructions in English.

### Système de coussins gonflables SRS

#### ■ Emplacement des coussins gonflables SRS

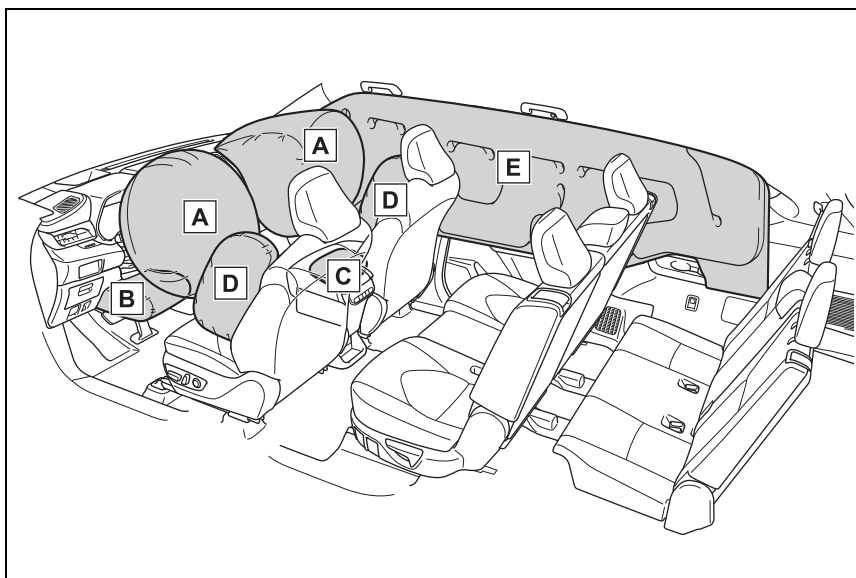

#### ► Coussins gonflables frontaux SRS

**A** Coussin gonflable conducteur/coussin gonflable du passager avant SRS

Participe à la protection de la tête et du thorax du conducteur et du passager avant contre les chocs contre les éléments de l'habitacle

**B** Coussin gonflable de genoux SRS

Participe à la protection du conducteur

**C** Coussin gonflable de coussin de siège SRS

Contribue à retenir le passager avant

► Coussins gonflables latéraux et rideaux SRS

**D** Coussins gonflables latéraux avant SRS

Participent à la protection du torse des occupants de siège avant

**E** Coussins gonflables rideaux SRS

- Participent principalement à la protection de la tête des occupants des sièges latéraux
- Peut contribuer à empêcher les occupants d'être éjectés du véhicule en cas de tonneau

■ **Composants du système de coussins gonflables SRS**

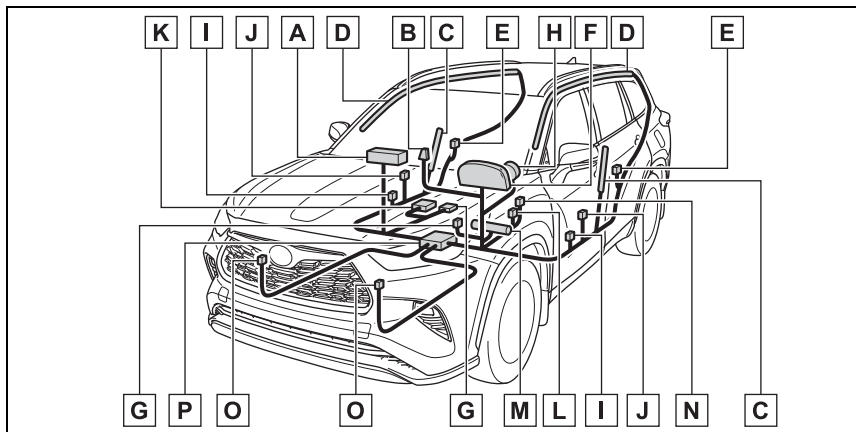

- A** Coussin gonflable passager avant
- B** Témoins indicateurs “PASS AIR BAG ON” et “PASS AIR BAG OFF”
- C** Coussins gonflables latéraux avant
- D** Coussins gonflables rideaux
- E** Capteurs d'impact latéral (arrière)
- F** Témoin d'avertissement SRS
- G** Système de classification de l'occupant du siège passager avant (ECU et capteurs)
- H** Coussin gonflable conducteur
- I** Capteurs d'impact latéral (porte avant)
- J** Prétensionneurs de ceintures de sécurité et limiteurs de force
- K** Coussin gonflable de coussin de siège
- L** Capteur de position du siège conducteur

- M** Coussin gonflable de genoux du conducteur
- N** Contact de boucle de ceinture de sécurité conducteur
- O** Capteurs d'impact avant
- P** Ensemble de capteurs de coussins gonflables

Votre véhicule est équipé de COUSSINS GONFLABLES INTELLIGENTS conçus selon les normes de sécurité américaines applicables aux véhicules à moteur (FMVSS208). L'ensemble de capteurs de coussins gonflables (ECU) régule le déploiement des coussins gonflables sur la base des informations qu'il reçoit des capteurs, etc., indiqués ci-dessus dans le schéma illustrant les composants du système. Parmi ces informations figurent la gravité du choc et l'occupation du véhicule par les passagers. Le déploiement rapide des coussins gonflables est obtenu au moyen d'une réaction chimique dans les dispositifs pyrotechniques, qui produit un gaz inoffensif permettant d'amortir le mouvement des occupants.



#### WARNING

##### ■ Précautions relatives aux coussins gonflables SRS

Respectez les précautions suivantes concernant les coussins gonflables SRS.

Le non-respect de ces précautions peut occasionner des blessures graves, voire mortelles.

- Le conducteur et tous les passagers du véhicule doivent porter correctement leur ceinture de sécurité. Les coussins gonflables SRS sont des dispositifs supplémentaires à utiliser avec les ceintures de sécurité.

- Le coussin gonflable conducteur SRS se déploie avec une force considérable, pouvant occasionner des blessures graves, voire mortelles, si le conducteur se trouve très près du coussin gonflable. L'autorité fédérale chargée de la sécurité routière aux États-Unis (NHTSA) conseille:

La zone à risque du coussin gonflable conducteur se situant dans les premiers 2 à 3 in. (50 à 75 mm) de déploiement, vous placer à 10 in. (250 mm) de votre coussin gonflable conducteur vous garantit une marge de sécurité suffisante. Cette distance est à mesurer entre le centre du volant et le sternum. Si vous êtes assis à moins de 10 in. (250 mm), vous pouvez changer votre position de conduite de plusieurs façons:

- Reculez votre siège le plus possible, de manière à pouvoir encore atteindre confortablement les pédales.

**⚠ WARNING**

- Inclinez légèrement le dossier du siège. Bien que les véhicules aient une conception différente, un grand nombre de conducteurs peuvent s'asseoir à une distance de 10 in. (250 mm), même avec le siège conducteur complètement avancé, simplement en inclinant un peu le dossier de siège. Si vous avez des difficultés à voir la route après avoir incliné le dossier de votre siège, utilisez un coussin ferme et antidérapant pour vous rehausser ou remontez le siège si votre véhicule est équipé de cette fonction.
- Si votre volant est réglable, inclinez-le vers le bas. Cela a pour effet d'orienter le coussin gonflable en direction de votre poitrine plutôt que de votre tête et de votre cou.

Réglez votre siège selon les recommandations de la NHTSA ci-dessus, tout en conservant le contrôle des pédales, du volant et la vue des commandes du tableau de bord.

- Si vous attachez une rallonge de ceinture de sécurité aux boucles de ceinture de sécurité avant, sans l'attacher au pêne de la ceinture de sécurité, les coussins gonflables frontaux SRS déterminent que le conducteur et le passager avant ont attaché leur ceinture de sécurité, bien que la ceinture de sécurité ne soit pas attachée. Dans ce cas, les coussins gonflables frontaux SRS peuvent ne pas se déployer correctement en cas de collision, pouvant occasionner des blessures graves, voire mortelles. Veillez à porter la ceinture de sécurité avec la rallonge de ceinture de sécurité.

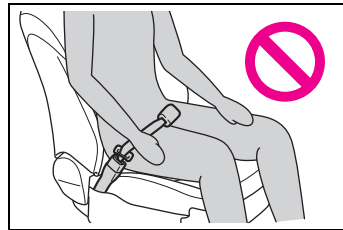

- Le coussin gonflable passager avant SRS se déploie également avec une force considérable, pouvant occasionner des blessures graves, voire mortelles, si le passager avant se trouve très près du coussin gonflable. Le siège du passager avant doit être éloigné le plus possible du coussin gonflable en réglant le dossier de siège de façon à ce que le passager avant soit assis bien droit dans le siège.

**⚠ WARNING**

- Les nourrissons et les enfants qui ne sont pas correctement assis et/ou attachés peuvent être grièvement blessés ou tués par le déploiement d'un coussin gonflable. Un nourrisson ou un enfant trop petit pour utiliser une ceinture de sécurité doit être correctement attaché au moyen d'un siège de sécurité enfant. Toyota recommande vivement d'installer tous les nourrissons et enfants sur les sièges arrière du véhicule et de prévoir pour eux des systèmes de retenue adaptés. Les sièges arrière sont plus sûrs pour les nourrissons et les enfants que le siège du passager avant.

- Ne vous asseyez pas sur le bord du siège et ne vous appuyez pas contre la planche de bord.

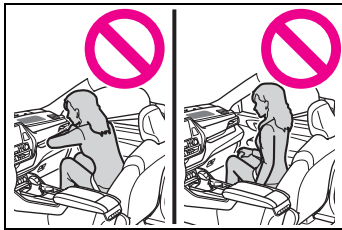

- Ne laissez pas un enfant rester debout devant le coussin gonflable passager avant SRS ou s'asseoir sur les genoux du passager avant.

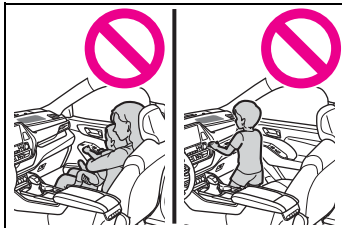

- Ne laissez pas les occupants des sièges avant voyager avec un objet sur les genoux.

- Ne vous appuyez pas contre la porte, le rail latéral de toit ou les montants avant, latéraux et arrière.

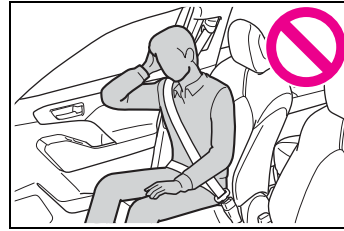

- Ne laissez personne s'agenouiller sur le siège passager en appui contre la porte ou sortir la tête ou les mains à l'extérieur du véhicule.

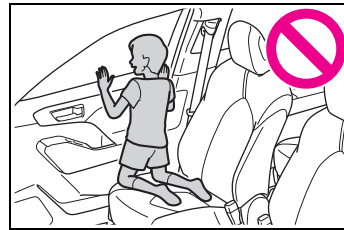

- Ne fixez rien et ne posez rien sur des emplacements tels que la planche de bord, la garniture du volant et la partie inférieure du tableau de bord. Ces éléments peuvent se transformer en projectiles lorsque les coussins gonflables conducteur, passager avant et genoux SRS se déploient.

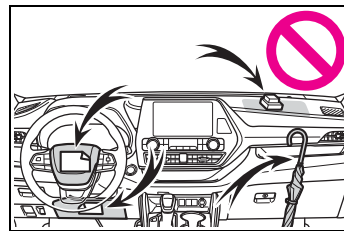



**⚠ WARNING**

- Ne fixez rien aux portes, à la vitre du pare-brise, aux vitres latérales, aux montants avant et arrière, au rail latéral de toit et à la poignée de maintien.

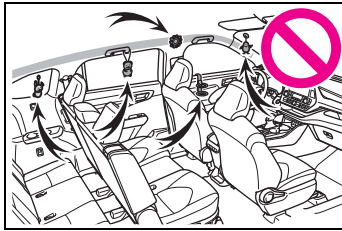

- Ne suspendez aucun cintre ou objet dur aux crochets à vêtements. Tous ces objets pourraient se transformer en projectiles et causer des blessures graves, voire mortelles en cas de déploiement des coussins gonflables rideaux SRS.
- Si un cache en vinyle est placé sur la zone où le coussin gonflable de genoux SRS se déploie, assurez-vous de le retirer.
- N'utilisez aucun accessoire de siège recouvrant les zones de déploiement des coussins gonflables latéraux SRS et du coussin gonflable de coussin de siège SRS, car il risque de gêner le déploiement des coussins gonflables SRS. De tels accessoires peuvent empêcher les coussins gonflables latéraux et le coussin gonflable de coussin de siège de s'activer correctement, désactiver le système ou entraîner le déploiement accidentel des coussins gonflables latéraux et du coussin gonflable de coussin de siège, occasionnant des blessures graves, voire mortelles.

- Évitez de faire subir des chocs ou des pressions excessives aux parties renfermant les composants de coussins gonflables SRS ou aux portes avant. En effet, cela pourrait entraîner un dysfonctionnement des coussins gonflables SRS.
- Ne touchez aucun composant immédiatement après le déploiement (gonflage) des coussins gonflables SRS, car ils peuvent être chauds.
- Si vous avez des difficultés à respirer après le déploiement des coussins gonflables SRS, ouvrez une porte ou une vitre pour faire entrer de l'air frais, ou bien descendez du véhicule si cela ne présente pas de danger. Essayez tout résidu dès que possible afin d'éviter d'éventuelles irritations de la peau.
- Si les parties renfermant les coussins gonflables SRS, comme les garnitures du volant et des montants avant et arrière, sont endommagées ou craquelées, faites-les remplacer par votre concessionnaire Toyota.
- Ne placez rien sur le siège du passager avant, comme un coussin par exemple. Cela a pour conséquence de répartir le poids du passager sur toute la surface du siège, ce qui empêche le capteur de détecter correctement le poids du passager. En conséquence, les coussins gonflables frontaux SRS du passager avant risquent de ne pas se déployer en cas de collision.



**WARNING**

■ **Modification et mise au rebut des composants du système de coussins gonflables SRS**

Ne mettez pas votre véhicule au rebut et ne procédez à aucune des modifications suivantes sans consulter votre concessionnaire Toyota. Les coussins gonflables SRS peuvent ne pas fonctionner correctement ou se déployer (se gonfler) accidentellement, provoquant la mort ou de graves blessures.

- Installation, dépose, démontage et réparation des coussins gonflables SRS
- Réparations, modifications, démontage ou remplacement du volant, du tableau de bord, de la planche de bord, des sièges ou de leur garnissage, des montants avant, latéraux et arrière, des rails latéraux de toit, des panneaux de porte avant, des garnitures de porte avant ou des haut-parleurs de porte avant
- Modifications du panneau de porte avant (par exemple, perçage d'un trou dans le panneau)
- Réparations ou modifications des ailes avant, du pare-chocs avant ou des flancs de l'habitacle
- Installation d'un protège-calandre (pare-buffle, pare-kangourou, etc.), de chasse-neige, de treuils ou d'un porte-bagages de toit
- Modifications du système de suspension du véhicule

● Installation d'appareils électroniques tels que les émetteurs/récepteurs radios mobiles et les lecteurs CD

● Modifications de votre véhicule pour une personne atteinte d'un handicap physique

### Headlight aim instructions for Canadian owners (in French)

The following is a French explanation of headlight aim instructions from the headlight aim section in this manual.

#### Boulons de réglage du mouvement vertical

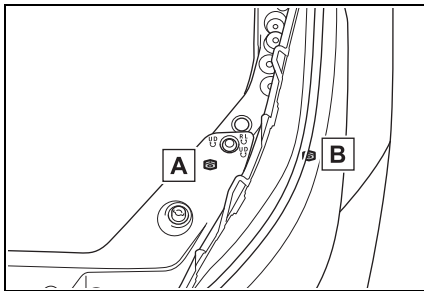

**A** Boulon de réglage A

**B** Boulon de réglage B

#### Avant de vérifier le réglage des phares

- Vérifiez que le réservoir de carburant du véhicule est plein et que la zone autour des phares n'est pas déformée.
- Stationnez le véhicule sur une surface plane.
- Assurez-vous que la pression de gonflage des pneus est au niveau recommandé.

- Faites asseoir quelqu'un dans le siège conducteur.
- Balancez le véhicule plusieurs fois.

#### Réglage du faisceau des phares

- 1 À l'aide d'un tournevis cruciforme, tournez le boulon A dans n'importe quel sens.

Mémorisez le sens dans lequel vous avez tourné et le nombre de tours.

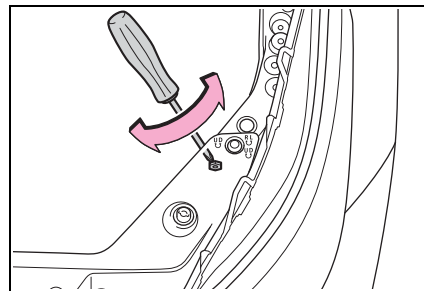

- 2 Tournez le boulon B du même nombre de tours dans le même sens qu'à l'étape 1.

Si vous n'arrivez pas à régler le phare en procédant de la sorte, confiez le véhicule à votre concessionnaire Toyota pour qu'il règle le faisceau des phares.

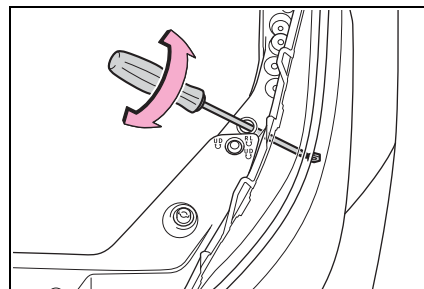



**Index**

**541**

What to do if... (Trouble-  
shooting) ..... **542**  
Alphabetical Index..... **545**

## What to do if... (Troubleshooting)

If you have a problem, check the following before contacting your Toyota dealer.

### The doors cannot be locked, unlocked, opened or closed



#### You lose your keys

- If you lose your mechanical keys, new genuine mechanical keys can be made by your Toyota dealer. (→P.479)
- If you lose your electronic keys, the risk of vehicle theft increases significantly. Contact your Toyota dealer immediately. (→P.479)



#### The doors cannot be locked or unlocked

- Is the electronic key battery weak or depleted? (→P.428)
- Is the engine switch in ON?

When locking the doors, turn the engine switch off. (→P.201)

- Is the electronic key left inside the vehicle?

When locking the doors, make sure that you have the electronic key on your person.

- The function may not operate

properly due to the condition of the radio wave. (→P.132)



#### The rear door cannot be opened

- Is the child-protector lock set?

The rear door cannot be opened from inside the vehicle when the lock is set. Open the rear door from outside and then unlock the child-protector lock. (→P.118)

### If you think something is wrong



#### The engine does not start

- Did you press the engine switch while firmly depressing the brake pedal? (→P.200)
- Is the shift lever in P? (→P.200)
- Is the electronic key anywhere detectable inside the vehicle? (→P.131)
- Is the steering wheel unlocked? (→P.200)
- Is the electronic key battery weak or depleted?

In this case, the engine can be started in a temporary way. (→P.482)

- Is the battery discharged? (→P.483)



**The shift lever cannot be shifted from P even if you depress the brake pedal**

- Is the engine switch in ON?

If you cannot release the shift lever by depressing the brake pedal with the engine switch in ON (→P.206)



**The steering wheel cannot be turned after the engine is stopped**

- It is locked automatically to prevent theft of the vehicle. (→P.200)



**The windows do not open or close by operating the power window switches**

- Is the window lock switch pressed?

The power window except for the one at the driver's seat cannot be operated if the window lock switch is pressed. (→P.166)



**The engine switch is turned off automatically**

- The auto power off function will be operated if the vehicle is left in ACC or ON (the engine is not running) for a period of time. (→P.203)



**A warning buzzer sounds during driving**

- The seat belt reminder light is flashing

Are the driver and the passengers wearing the seat belts? (→P.453)

- The parking brake indicator is on

Is the parking brake released? (→P.209)

Depending on the situation, other types of warning buzzer may also sound. (→P.450, 460)



**An alarm is activated and the horn sounds (vehicles with an alarm)**

- Did anyone inside the vehicle open a door during setting the alarm?

The sensor detects it and the alarm sounds. (→P.71)

Do one of the following to stop the alarms:

- Unlock the doors.
- Turn the engine switch to ACC or ON, or start the engine.



**A warning buzzer sounds when leaving the vehicle**

- Is the message displayed on the multi-information display?

Check the message on the multi-information display. (→P.460)



**A warning light turns on or a warning message is displayed**

- When a warning light turns on

## 544 What to do if... (Troubleshooting)

or a warning message is displayed, refer to P.450, 460.

### When a problem has occurred



#### If you have a flat tire

- Stop the vehicle in a safe place and replace the flat tire with the spare tire. (→P.464)



#### The vehicle becomes stuck

- Try the procedure for when the vehicle becomes stuck in mud, dirt, or snow. (→P.489)



## Alphabetical Index

### A

<b>A/C</b> .....	<b>328, 333</b>
Air conditioning filter .....	426
Automatic air conditioning system .....	333
Eco air conditioning mode ....	340
Front seat concentrated airflow mode (S-FLOW) .....	342
Manual air conditioning system .....	328
Rear automatic air conditioning system .....	348
Rear manual air conditioning system .....	346
<b>ABS (Anti-lock Brake System)</b> .....	<b>313</b>
Warning light .....	452
<b>ACA (Active Cornering Assist)</b> .....	<b>313</b>
<b>Active Cornering Assist (ACA)</b> .....	<b>313</b>
<b>Adaptive Front-lighting System (AFS)</b> .....	<b>216</b>
<b>AFS (Adaptive Front-lighting System)</b> .....	<b>216</b>
<b>AHB (Automatic High Beam)</b> .....	<b>217</b>
<b>Air conditioning filter</b> .....	<b>426</b>
<b>Air conditioning system</b> .....	<b>328, 333</b>
Air conditioning filter .....	426
Automatic air conditioning system .....	333
Eco air conditioning mode ....	340
Front seat concentrated airflow mode (S-FLOW) .....	342
Manual air conditioning system .....	328
Rear automatic air conditioning system .....	348
Rear manual air conditioning system .....	346

### Airbags

Airbag operating conditions ....	34
Airbag precautions for your child .....	37
Correct driving posture .....	23
Curtain shield airbag operating conditions .....	35
Curtain shield airbag precautions .....	37
Front passenger occupant classification system .....	41
General airbag precautions ....	37
Locations of airbags .....	32
Modification and disposal of airbags .....	40
Side airbag operating conditions .....	35
Side airbag precautions .....	37
Side and curtain shield airbags operating conditions .....	35
Side and curtain shield airbags precautions .....	37
SRS airbags .....	32
SRS warning light .....	451
<b>Alarm</b> .....	<b>71</b>
Warning buzzer .....	450
<b>Anchor brackets</b> .....	<b>50, 60</b>
<b>Antennas (smart key system)</b> .....	<b>131</b>
<b>Anti-lock Brake System (ABS)</b> .....	<b>313</b>
Warning light .....	452
<b>Approach warning</b> .....	<b>261</b>
<b>Armrest</b> .....	<b>375</b>
<b>Assist grips</b> .....	<b>375</b>
<b>Audio system-linked display</b> .....	<b>86, 95</b>
<b>Automatic air conditioning system</b> .....	<b>333</b>
Eco air conditioning mode ....	340
<b>Automatic headlight leveling system</b> .....	<b>215</b>
<b>Automatic High Beam</b> .....	<b>217</b>

**Automatic light control system**  
.....215

**Automatic transmission** .....204

    If the shift lever cannot be shifted  
    from P.....206

    M mode .....206

**Auxiliary boxes**.....361, 366

**Average fuel economy** ..... 84, 92

**Average vehicle speed**..... 86, 95

**AWD Control** ..... 87, 95

**B**

**Back door**..... 119

**Back-up lights**

    Replacing light bulbs ..... 432

**Battery**

    Battery checking.....408

    If the battery is discharged ...483

    Preparing and checking before  
    winter.....319

    Replacing .....485

    Warning light .....451

**Blind Spot Monitor (BSM)**.....270

**Brake**

    Brake hold .....212

    Fluid .....408, 499

    Parking brake .....209

    Warning light .....450

**Brake assist** .....313

**Break-in tips** ..... 178

**Brightness control**

    Instrument panel light control .81

**BSM (Blind Spot Monitor)**.....270

**Buzzer**

    Hands off steering wheel warn-  
    ing (LTA) .....249

**C**

**Care**

    Exterior .....388

    Interior .....391

    Seat belts .....391

    Wheels and wheel ornaments  
    .....388

**Cargo capacity**.....187

**Cargo net hooks** .....363

**Chains**.....320

**Child restraint system**

    Fixed with a LATCH system ...58

    Fixed with a seat belt.....53

    Front passenger occupant clas-  
    sification system .....41

    Points to remember .....48

    Riding with children .....47

    Types of child restraint system  
    installation method .....50

    Using an anchor bracket .....60

**Child safety**

    Airbag precautions .....37

    Back door precautions.....119

    Battery precautions .....409, 486

    Child restraint system.....50

    Heated steering wheel and seat  
    heater precautions.....352

    How your child should wear the  
    seat belt.....26

    Moon roof precautions.....168

    Panoramic moon roof precau-  
    tions.....172

    Power window lock switch...166

    Power window precautions...165

    Rear door child-protectors...118

    Removed electronic key battery  
    precautions .....429

    Seat belt extender precautions  
    .....27

    Seat belt precautions.....47

**Child-protectors**.....118

**Cleaning**

    Exterior .....388

    Interior .....391

    Radar sensor .....228

    Seat belts .....391

Wheels and wheel ornaments .....388

**Clock** .....79, 82

**Coat hooks**.....376

**Condenser** .....408

**Console box**.....359

**Consumption screen**.....106

**Conversation mirror**.....378

**Cooling system** .....407

    Engine overheating .....487

**Cruise control**

    Dynamic radar cruise control  
    with full-speed range .....254

**Cup holders** .....360

**Current fuel consumption** .84, 92

**Curtain shield airbags** .....32

**Customizable features** .....515

**D**

**Daytime running light system**214

    Replacing light bulbs .....432

**Defogger**

    Outside rear view mirrors ... 329,  
    335, 339

    Rear window .....329, 335, 339

    Windshield.....329, 335, 338

**Differential**

    Rear differential oil .....498

**Digital Rearview Mirror** .....152

**Dimension** .....492

**Dinghy towing** .....199

**Display**

    Dynamic radar cruise control  
    with full-speed range .....254

    Head-up display .....101

    Intuitive parking assist .....276

    LTA (Lane Tracing Assist).....246

    Multi-information display ..82, 91

    RCTA.....284

    Toyota Multi-operation touch 326

    Warning message .....460

**Distance until next engine oil  
change** .....81

**Do-it-yourself maintenance** ...395

**Door courtesy lights**.....355

**Door lock**

    Back door .....119

    Side doors .....115

    Smart key system .....131

    Wireless remote control.....113

**Doors**

    Automatic door locking and  
    unlocking system .....118

    Back door .....119

    Door glasses .....164

    Door lock .....119

    Open door warning buzzer .116,  
    118

    Outside rear view mirrors ....162

    Rear door child-protectors ....118

**Downhill assist control system**  
.....311

**Drive distance** .....86, 95

**Drive information**.....86, 95

**Driver's seat position memory**

    Driving position memory .....144

    Memory recall function .....145

**Drive-start control** .....178

**Driving**

    Break-in tips .....178

    Correct driving posture .....23

    Driving mode select switch...306

    Procedures .....177

    Winter drive tips.....319

**Driving information display**83, 92

**Driving mode select switch** ...306

**Driving position memory** .....144

    Memory recall function .....145

**Driving range** .....84, 92, 93

**Driving support system information display**.....85, 95

**Dynamic radar cruise control**  
**with full-speed range** .....254  
 Warning message .....263  
**Dynamic Torque Control AWD**  
**system**.....314  
**Dynamic Torque Vectoring AWD**  
**system**.....314

**E**

**Eco drive mode** .....306  
**Eco Driving Indicator** .84, 93, 104  
**Eco Driving Indicator Light**84, 93  
**EDR (Event data recorder)**.....7  
**Elapsed time** .....86, 95  
**Electric Power Steering (EPS)**  
 .....313  
 Warning light .....452  
**Electronic key** .....112  
 Battery-saving function.....132  
 If the electronic key does not  
 operate properly .....481  
 Replacing the battery .....428  
**Electronic roof sunshade**  
 Jam protection function .....171  
 Operation .....170  
**Emergency flashers** .....442  
**Emergency, in case of**  
 If a warning buzzer sounds ..450  
 If a warning light turns on .....450  
 If a warning message is dis-  
 played.....460  
 If the battery is discharged ...483  
 If the electronic key does not  
 operate properly .....481  
 If the engine will not start .....478  
 If the fuel filler door cannot be  
 opened .....480  
 If the vehicle is trapped in rising  
 water .....443  
 If you have a flat tire .....464  
 If you lose your keys .....479

If you think something is wrong  
 .....448  
 If your vehicle becomes stuck  
 .....489  
 If your vehicle has to be stopped  
 in an emergency.....442  
 If your vehicle needs to be towed  
 .....445  
 If your vehicle overheats .....487

**Engine**

ACCESSORY mode .....203  
 Compartment.....404  
 Engine switch .....200  
 Fuel pump shut off system ...449  
 Hood.....402  
 How to start the engine .....200  
 Identification number .....494  
 If the engine will not start.....478  
 If your vehicle has to be stopped  
 in an emergency.....442  
 Ignition switch (engine switch)  
 .....200  
 Overheating.....487  
 Tachometer.....79

**Engine coolant**

Capacity .....497  
 Checking .....407  
 Preparing and checking before  
 winter.....319

**Engine coolant temperature**

**gauge**.....79

**Engine immobilizer system** .....69

**Engine oil**

Capacity .....495  
 Checking .....404  
 Preparing and checking before  
 winter.....319  
 Warning light.....451

**Engine oil maintenance data**.406

**Engine switch** .....200

Auto power off function.....203

Changing the engine switch modes ..... 203  
 If your vehicle has to be stopped in an emergency..... 442  
**EPS (Electric Power Steering)** ..... 313  
 Warning light ..... 452  
**Event data recorder (EDR)**..... 7

**F**

**Flat tire**  
 Tire pressure warning system ..... 414  
 Vehicles with a spare tire .... 464  
**Floor mats** ..... 22  
**Fluid**  
 Automatic transmission ..... 497  
 Brake ..... 499  
 Washer ..... 410  
**Fog lights**  
 Replacing light bulbs ..... 432  
 Switch..... 220  
**Footwell light** ..... 355  
**Front passenger occupant classification system** ..... 41  
**Front seats**  
 Adjustment ..... 138  
 Cleaning ..... 391  
 Correct driving posture ..... 23  
 Driving position memory ..... 144  
 Head restraints ..... 147  
 Memory recall function ..... 145  
 Seat heaters ..... 352  
 Seat position memory ..... 144  
 Seat ventilators ..... 352  
**Front side marker light**  
 Light switch ..... 214  
**Front side marker lights**  
 Replacing light bulbs ..... 432  
**Front turn signal lights**  
 Replacing light bulbs ..... 432  
 Turn signal lever ..... 208

**Fuel**  
 Capacity ..... 495  
 Fuel gauge ..... 79  
 Fuel pump shut off system ... 449  
 Information ..... 503  
 Refueling ..... 225  
 Type..... 495  
 Warning light..... 453  
**Fuel consumption**  
 Average fuel economy ..... 84, 92  
 Current fuel consumption .84, 92  
**Fuel economy** ..... 84, 92  
**Fuel filler door**  
 If the fuel filler door cannot be opened ..... 480  
 Refueling ..... 225  
**Fuel gauge**..... 79  
**Fuel pump shut off system**.... 449  
**Fuses** ..... 429

**G**

**Garage door opener** ..... 379  
**Gauges** ..... 79  
**Glove box** ..... 359  
**Glove box light**..... 359

**H**

**Head restraints** ..... 147  
**Headlight aim** ..... 431  
**Headlights**  
 Adaptive Front-lighting System (AFS) ..... 216  
 Automatic High Beam system ..... 217  
 Light switch..... 214  
 Replacing light bulbs ..... 432  
**Head-up display**..... 101  
 Driving information display area ..... 101  
 Eco Driving Indicator ..... 104

Navigation system-linked display ..... 104  
 Settings ..... 102  
**Heated steering wheel ..... 352**  
**Heaters**  
 Automatic air conditioning system ..... 333  
 Heated steering wheel ..... 352  
 Manual air conditioning system ..... 328  
 Outside rear view mirrors ... 329, 335, 339  
 Rear automatic air conditioning system ..... 348  
 Rear manual air conditioning system ..... 346  
 Seat heaters ..... 352  
**High mounted stoplight**  
 Replacing light bulbs ..... 432  
**Hill-start assist control ..... 313**  
**Hood**  
 Open ..... 402  
**Hooks**  
 Cargo net hooks ..... 363  
 Coat hooks ..... 376  
 Retaining hooks (floor mat) ... 22  
**Horn ..... 150**

**I**

**I/M test ..... 398**  
**Identification**  
 Engine ..... 494  
 Vehicle ..... 492  
**Ignition switch (engine switch) ..... 200**  
 Auto power off function ..... 203  
 Changing the engine switch modes ..... 203  
 If your vehicle has to be stopped in an emergency ..... 442  
**Indicators ..... 76**

**Initialization**  
 Items to initialize ..... 527  
 Maintenance ..... 395, 406  
 Power windows ..... 164  
 Tire pressure warning system ..... 417  
**Inside rear view mirror ... 151, 152**  
**Instrument panel light control. 81**  
**Interior lights ..... 355**  
 Front interior light ..... 355  
 Rear interior light ..... 355  
**Intuitive parking assist**  
 Function ..... 276  
 Warning message ..... 279

**J**

**Jack**  
 Positioning a floor jack ..... 403  
 Vehicle-equipped jack ..... 465  
**Jack handle ..... 465**  
**Jam protection function**  
 Electronic roof sunshade ..... 171  
 Moon roof ..... 167  
 Panoramic moon roof ..... 171  
 Power back door ..... 125  
 Power windows ..... 164

**K**

**Keyless entry**  
 Smart key system ..... 131  
 Wireless remote control ..... 113  
**Keys**  
 Battery-saving function ..... 132  
 Electronic key ..... 112  
 Engine switch ..... 200  
 If the electronic key does not operate properly ..... 481  
 If you lose your keys ..... 479  
 Key number plate ..... 112  
 Keyless entry ..... 115, 121, 131  
 Mechanical key ..... 112

- Replacing the battery ..... 428
- Warning buzzer ..... 131
- Wireless remote control ..... 113
- Knee airbags..... 32**

**L**

- Lane Tracing Assist (LTA)**
  - Operation ..... 241
  - Warning messages..... 250
- Language (multi-information display)..... 87, 96**
- LATCH anchors ..... 58**
- Lever**
  - Auxiliary catch lever ..... 402
  - Hood lock release lever..... 402
  - Shift lever ..... 204
  - Turn signal lever..... 208
  - Wiper lever ..... 220, 223
- License plate lights**
  - Light switch ..... 214
  - Replacing light bulbs ..... 432
- Light bulbs**
  - Replacing ..... 432
- Lights**
  - Automatic High Beam system ..... 217
  - Fog light switch ..... 220
  - Front interior lights ..... 356
  - Front personal lights..... 356
  - Headlight switch ..... 214
  - Interior lights..... 355
  - Interior lights list ..... 355
  - Rear interior lights ..... 356
  - Rear personal lights ..... 356
  - Replacing light bulbs ..... 432
  - Turn signal lever..... 208
  - Vanity lights ..... 377
  - Welcome light illumination control ..... 215
- Lock steering column ..... 200**
- LTA (Lane Tracing Assist)**
  - Operation ..... 241

- Warning messages.....250
- Luggage cover .....363**

**M**

- Maintenance**
  - Do-it-yourself maintenance ..400
  - General maintenance .....396
  - Maintenance data.....492
  - Maintenance requirements...394
- Malfunction indicator lamp....451**
- Manual air conditioning system .....328**
- Menu icons.....82, 91**
- Meter**
  - Clock .....79, 82
  - Indicators.....76
  - Instrument panel light control .81
  - Meter control switches.....83, 92
  - Meters .....79
  - Multi-information display...82, 91
  - Settings .....87, 96
  - Warning lights.....450
  - Warning message.....460
- Mirrors**
  - Digital Rearview Mirror .....152
  - Inside rear view mirror .....151
  - Outside rear view mirror defoggers .....329, 335, 339
  - Outside rear view mirrors .....162
  - Vanity mirrors.....377
- Moon roof**
  - Door lock linked moon roof operation.....167
  - Jam protection function .....167
  - Operation.....167
- Mud & Sand mode .....307**
- Multi Weather Lights**
  - Switch.....220
- Multi-information display...82, 91**
  - Audio system-linked display .86, 95
  - AWD Control.....87, 95

Driving information display 83, 92  
 Driving support system ..... 96  
 Driving support system information display ..... 85, 95  
 Dynamic radar cruise control  
   with full-speed range ..... 254  
 Eco Driving Indicator ..... 84, 93  
 Fuel economy ..... 84, 92  
 LTA (Lane Tracing Assist) ..... 246  
 Menu icons ..... 82, 91  
 Meter control switches ..... 83, 92  
 Navigation system-linked display  
   ..... 85, 95  
 Pop-up display ..... 82, 91  
 Settings ..... 87, 96  
 Suggestion function ..... 91, 100  
 Tire pressure ..... 86, 95, 414  
 Vehicle information display 86, 95  
 Warning message .. 90, 100, 460  
**Multi-terrain Select ..... 307**

**N**

**Navigation system-linked display  
 ..... 85, 95, 104**  
**Noise from under vehicle ..... 5**  
**Normal mode ..... 306, 308**

**O**

**“ODO TRIP” switch ..... 81**  
**Odometer ..... 81**  
**Odometer and trip meter display**  
   Display items ..... 81  
   “ODO TRIP” switch ..... 81  
   Pop-up display ..... 81  
**Oil**  
   Engine oil ..... 495  
   Rear differential oil ..... 498  
**Opener**  
   Back door ..... 121  
   Fuel filler door ..... 225  
   Hood ..... 402

**Outer foot lights**  
   Replacing light bulbs ..... 432  
**Outside rear view mirrors**  
   Adjustment ..... 162  
   BSM (Blind Spot Monitor) ..... 270  
   Linked mirror function when  
     reversing ..... 162  
   Mirror position memory ..... 144  
   Outside rear view mirror defog-  
     gers ..... 329, 335, 339  
   RCTA function ..... 284  
**Outside temperature ..... 79**  
**Overheating ..... 487**

**P**

**Panic mode ..... 114**  
**Panoramic moon roof**  
   Jam protection function ..... 171  
   Operation ..... 170  
**Parking assist sensors (intuitive  
 parking assist) ..... 276**  
**Parking brake**  
   Operation ..... 209  
   Parking brake engaged warning  
     buzzer ..... 211  
   Warning light ..... 457  
   Warning message ..... 211  
**Parking lights**  
   Light switch ..... 214  
   Replacing light bulbs ..... 432  
**Parking Support Brake function  
 (for rear-crossing vehicles) .302**  
   Function ..... 302  
**Parking Support Brake function  
 (static objects) ..... 296**  
   Function ..... 296  
**PCS (Pre-Collision System)**  
   Function ..... 233  
   PCS OFF switch ..... 235  
   Warning light ..... 456  
**Personal lights ..... 355**



**PKSB (Parking Support Brake)**  
 .....289  
 Warning message .....294  
**Power outlets**.....376  
**Power steering (Electric power steering system)**.....313  
 Warning light .....452  
**Power windows**  
 Door lock linked window operation .....165  
 Jam protection function .....164  
 Operation .....164  
 Window lock switch .....166  
**Pre-Collision System (PCS)**  
 Function .....233  
 PCS OFF switch.....235  
 Warning light .....456

**R**

**Radar cruise control (dynamic radar cruise control with full-speed range)** .....254  
**Radiator**.....408  
**RCTA**  
 Function .....284  
 Warning message .....285  
**RCTA function**.....286  
**Rear automatic air conditioning system**.....348  
**Rear Cross Traffic Alert (RCTA)**  
 .....284  
**Rear door sunshades** .....378  
**Rear fog lights**  
 Switch.....220  
**Rear manual air conditioning system**.....346  
**Rear seats** .....139  
 Head restraints .....147  
 Seat heaters .....352  
**Rear side marker lights**  
 Light switch .....214  
 Replacing light bulbs .....432

**Rear turn signal lights**  
 Replacing light bulbs .....432  
 Turn signal lever .....208  
**Rear view mirror**  
 Digital Rearview Mirror .....152  
 Inside rear view mirror .....151  
 Outside rear view mirrors .....162  
**Rear window defogger** ..329, 335, 339  
**Refueling**  
 Capacity .....495  
 Fuel types .....495  
 If the fuel filler door cannot be opened .....480  
 Opening the fuel tank cap ....225  
**Replacing**  
 Electronic key battery .....428  
 Fuses.....429  
 Light bulbs .....432  
 Tires.....464  
**Reporting safety defects for U.S. owners**.....530  
**Resetting the message indicating maintenance is required**395  
**Road Sign Assist** .....251  
**Rock & Dirt mode** .....307  
**RSA (Road Sign Assist)** .....251

**S**

**Safety Connect** .....63  
**Seat belt reminder light**.....453  
**Seat belts**.....25  
 Automatic Locking Retractor ..26  
 Child restraint system installation .....50  
 Cleaning and maintaining the seat belt.....391  
 Emergency Locking Retractor 26  
 How to wear your seat belt.....26  
 How your child should wear the seat belt.....26

Pregnant women, proper seat belt use.....	25
Reminder light and buzzer ...	453
Seat belt extender .....	26
Seat belt pretensioners .....	30
SRS warning light.....	451
<b>Seat heaters .....</b>	<b>352</b>
<b>Seat position memory.....</b>	<b>144</b>
<b>Seat ventilators .....</b>	<b>352</b>
<b>Seating capacity .....</b>	<b>187</b>
<b>Seats</b>	
Adjustment .....	138
Adjustment precautions.....	138
Child seats/child restraint system installation .....	48
Cleaning .....	391
Driving position memory.....	144
Head restraints .....	147
Properly sitting in the seat.....	23
Seat heaters .....	352
Seat position memory .....	144
Seat ventilators .....	352
<b>Sensor</b>	
Automatic headlight system ..	215
Automatic High Beam system .....	217
Digital Rearview Mirror .....	156
Inside rear view mirror.....	152
Intuitive parking assist.....	276
LTA (Lane Tracing Assist).....	241
Parking Support Brake function (rear-crossing vehicles).....	302
Parking Support Brake function (static objects) .....	297
Radar sensor.....	227, 272
Rain-sensing windshield wipers .....	222
RCTA.....	285
<b>Service reminder message....</b>	<b>395</b>
<b>Shift lever</b>	
Automatic transmission .....	204
If the shift lever cannot be shifted from P .....	206
<b>Shift lever light.....</b>	<b>355</b>
<b>Shift lock system .....</b>	<b>205</b>
<b>Shopping bag hooks .....</b>	<b>363</b>
<b>Side airbags .....</b>	<b>32</b>
<b>Side doors</b>	
Door lock .....	115
<b>Side marker lights</b>	
Light switch.....	214
Replacing light bulbs .....	432
<b>Side mirrors</b>	
Adjustment .....	162
BSM (Blind Spot Monitor)....	270
Heaters .....	329, 335, 339
Linked mirror function when reversing.....	162
Mirror position memory.....	144
RCTA function.....	284
<b>Side turn signal lights</b>	
Replacing light bulbs .....	432
Turn signal lever .....	208
<b>Side windows.....</b>	<b>164</b>
<b>Smart key system</b>	
Antenna location.....	131
Entry functions.....	115, 121
Starting the engine .....	200
<b>Snow mode switch .....</b>	<b>310</b>
<b>Snow tires .....</b>	<b>319</b>
<b>Spare tire .....</b>	<b>464</b>
Storage location .....	465
<b>Spark plug .....</b>	<b>497</b>
<b>Specifications .....</b>	<b>492</b>
<b>Speedometer .....</b>	<b>79</b>
<b>Sport mode.....</b>	<b>306</b>
<b>Steering lock</b>	
Column lock release .....	200
Steering lock system warning message.....	200
<b>Steering wheel</b>	
Adjustment .....	150
Heated steering wheel.....	352

Meter control switches ..... 83, 92

**Stop & Start system** ..... **264**

Warning light ..... 454

**Stop lights**

Replacing light bulbs ..... 432

**Storage features** ..... **358**

**Stuck**

If the vehicle becomes stuck 489

**Suggestion function**..... **91, 100**

**Sun visors**..... **377**

**Sunshade**

Roof..... 167

**Switches**

Activating the Automatic High Beam.....217

Automatic High Beam system .....217

Brake Hold switch .....212

Digital Rearview Mirror control switches ..... 152

Door lock switches ..... 118

Driving mode select switch...306

Driving position memory switches ..... 144

Dynamic radar cruise control with full-speed range switch254

Electronic roof sunshade switches ..... 170

Emergency flashers switch ..442

Engine switch .....200

Fog light switch .....220

Garage door opener switches .....379

Heated steering wheel switch .....352

Ignition switch.....200

Instrument panel light control switches ..... 81

Intuitive parking assist switch277

Light switches..... 214

LTA (Lane Tracing Assist) switch .....246

Meter control switches.....83, 92

Moon roof switches .....167

“ODO TRIP” switch.....81

Outside rear view mirror switches.....162

Panoramic moon roof switches .....170

Parking brake switch .....209

PCS OFF switch.....235

PKSB (Parking Support Brake) switch .....290

Power door lock switch..... 118

Power window switches .....164

RCTA switch .....284

Rear window and outside rear view mirror defoggers switch .....329, 335, 339

Seat heater switches .....352

Seat ventilator switches.....352

Snow mode switch .....310

“SOS” button .....63

Stop & Start cancel switch...265

Tilt and telescopic steering control switch .....150

Tire pressure warning reset switch .....417

Vehicle-to-vehicle distance switch .....254

VSC OFF switch.....314

Window lock switch .....166

Windshield defogger switch329, 335, 338

Windshield wiper and washer switch .....220, 223

Windshield wiper de-icer switch .....330, 335, 343

**T**

**Tachometer** ..... **79**

**Tail lights**

Light switch.....214

Replacing light bulbs .....432

**The Secondary Collision Brake** .....314

**Theft deterrent system**  
   Alarm..... 71  
   Engine immobilizer system .... 69

**Tire inflation pressure**  
   Maintenance data..... 499  
   Tire inflation pressure display  
     function..... 414  
   Warning light ..... 454

**Tire information** .....505  
   Glossary ..... 509  
   Size ..... 507  
   Tire identification number ..... 506  
   Uniform Tire Quality Grading 508

**Tire pressure display** .....414

**Tire pressure warning system**  
   Function ..... 414  
   Initializing ..... 417  
   Installing tire pressure warning  
     valves and transmitters ..... 416  
   Registering ID codes..... 420  
   Warning light ..... 454

**Tires**  
   Chains ..... 320  
   Checking ..... 411  
   If you have a flat tire..... 464  
   Inflation pressure..... 423  
   Information ..... 505  
   Replacing ..... 464  
   Rotating tires ..... 413  
   Size ..... 499  
   Snow tires ..... 319  
   Spare tire..... 464  
   Tire inflation pressure display  
     function..... 414  
   Tire pressure warning system  
     ..... 414  
   Warning light ..... 454

**Tools** ..... 465

**Top tether strap** ..... 60

**Total load capacity** ..... 492

**Towing**  
   Dinghy towing ..... 199  
   Emergency towing ..... 445  
   Trailer towing ..... 188

**Toyota Multi-operation touch** 326

**Toyota Safety Sense 2.0**  
   Automatic High Beam..... 217  
   Dynamic radar cruise control  
     with full-speed range ..... 254  
   LTA (Lane Tracing Assist) ..... 241  
   PCS (Pre-Collision System) . 233  
   RSA (Road Sign Assist)..... 251

**TRAC (Traction Control)** .....313

**Traction Control (TRAC)** .....313

**Trailer Sway Control**.....313

**Trailer towing** .....188

**Transmission**  
   Automatic transmission ..... 204  
   Driving mode select switch... 306  
   If the shift lever cannot be shifted  
     from P ..... 206  
   M mode ..... 206

**Trip meters** .....81

**Trunk**..... 119  
   Trunk features ..... 363

**Turn signal lights**  
   Replacing light bulbs ..... 432  
   Turn signal lever ..... 208

**U**

**USB charging ports**.....367

**V**

**Vanity lights** .....377

**Vanity mirrors** .....377

**Vehicle data recording** .....6

**Vehicle identification number**492

**Vehicle information display**86, 95

**Vehicle Stability Control (VSC)**  
   .....313

**Ventilators (seat ventilators)** .352

**VSC (Vehicle Stability Control)**  
.....**313**

**W**

**Warning buzzers**

ABS .....	452
Airbags .....	451
Approach warning .....	261
Brake hold .....	457
Brake Override System .....	452
Brake system .....	450
Charging system .....	451
Downshifting.....	207
Drive-Start Control .....	452
Electric power steering .....	452
Engine .....	451
Hands off steering wheel warn- ing (LTA).....	249
High coolant temperature .....	450
Intuitive parking assist. 280, 283, 455	
Low engine oil pressure .....	451
LTA (Lane Tracing Assist)... 241, 244, 454	
Open door .....	116, 118
PKSB (Parking Support Brake) .....	455
Pre-collision braking.....	234
RCTA (Rear Cross Traffic Alert) .....	455
RCTA function .....	285
Seat belt .....	453

**Warning lights .....450**

ABS .....	452
Brake hold operated indicator .....	457
Brake Override System .....	452
Brake system .....	450
Charging system .....	451
Drive-Start Control .....	452
Electric power steering .....	452
High coolant temperature.....	450

Intuitive parking assist OFF indi- cator .....	455
Low engine oil pressure .....	451
Low fuel level.....	453
LTA indicator .....	454
Malfunction indicator lamp....	451
Parking brake indicator.....	457
PKSB OFF indicator .....	455
Pre-collision system .....	456
RCTA OFF indicator .....	455
Seat belt reminder light .....	453
Slip indicator .....	456
SRS .....	451
Stop & Start cancel indicator	454
Tire pressure .....	454

**Warning message.....90, 100**

**Warning messages .....460**

**Washer**

Adding .....	410
Preparing and checking before winter.....	319
Switch.....	220, 223

**Washing and waxing .....388**

**Weight**

Cargo capacity .....	187
Load limits .....	187
Weight .....	492

**Wheels .....425**

Size .....	499
------------	-----

**Window lock switch .....166**

**Windows**

Power windows .....	164
Rear window defogger 329, 335, 339	
Washer .....	220, 223

**Windshield defogger .....329, 335,  
338**

**Windshield wiper de-icer .....330,  
335, 343**

**Windshield wipers**

Rain-sensing windshield wipers .....	220, 223
---	----------

**Winter driving tips**.....319  
**Wireless charger** .....368  
**Wireless remote control**  
    Battery-Saving Function ..... 132  
    Locking/Unlocking ..... 113  
    Replacing the battery .....428

---

---

**For information regarding the equipment listed below, refer to the “NAVIGATION AND MULTIMEDIA SYSTEM OWNER’S MANUAL”.**

- Navigation system
- Audio/visual system
- Rear seat entertainment system
- Rear view monitor system
- Toyota parking assist monitor
- Panoramic view monitor

HIGHLANDER\_U

## GAS STATION INFORMATION

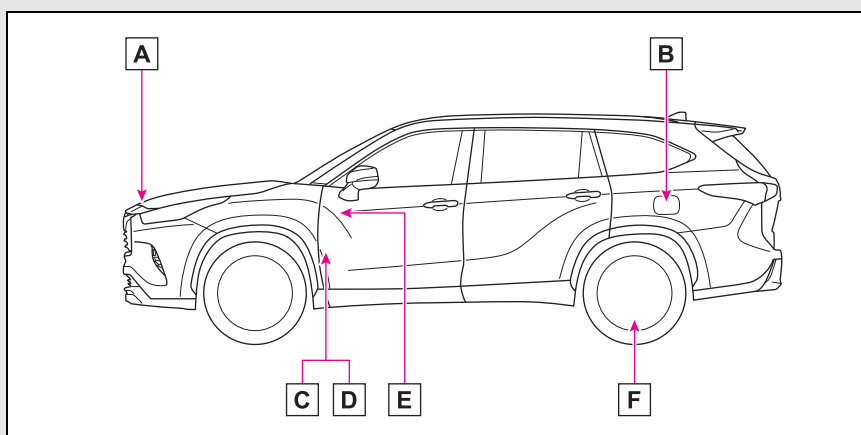

- A** Auxiliary catch lever (→P.402)
- B** Fuel filler door (→P.226)
- C** Hood lock release lever (→P.402)
- D** Fuel filler door opener (→P.226)
- E** Power back door switch\* (→P.122)
- F** Tire inflation pressure (→P.499)

\*: If equipped

Fuel tank capacity (Reference)	17.9 gal. (68 L, 14.9 Imp. gal.)	
Fuel type	Unleaded gasoline only	P.495
Cold tire inflation pressure		P.499
Engine oil capacity (Drain and refill — reference)		P.495
Engine oil type		P.495