



# 2021 DODGE CHALLENGER OWNER'S MANUAL

This Owner's Manual illustrates and describes the operation of features and equipment that are either standard or optional on this vehicle. This manual may also include a description of features and equipment that are no longer available or were not ordered on this vehicle. Please disregard any features and equipment described in this manual that are not on this vehicle. FCA US LLC reserves the right to make changes in design and specifications, and/or make additions to or improvements to its products without imposing any obligation upon itself to install them on products previously manufactured.

With respect to any vehicles sold in Canada, the name FCA US LLC shall be deemed to be deleted and the name FCA Canada Inc. used in substitution therefore.

This Owner's Manual is intended to familiarize you with the important features of your vehicle. Your most up-to-date Owner's Manual, Navigation/Uconnect manuals and Warranty Booklet can be found by visiting the website on the back cover.

**U.S. Residents:** If you are the first registered retail owner of your vehicle, you may obtain a complimentary printed copy of the Warranty Booklet by calling **1-800-423-6343** or by contacting your dealer. Replacement kits can be purchased by visiting [www.techauthority.com](http://www.techauthority.com).

**Canadian Residents:** If you are the first registered retail owner of your vehicle, you may obtain a complimentary printed copy of the Warranty Booklet or purchase a replacement kit by calling **1-800-387-1143** or by contacting your dealer.

 **WARNING:** Operating, servicing and maintaining a passenger vehicle or off-highway motor vehicle can expose you to chemicals including engine exhaust, carbon monoxide, phthalates, and lead, which are known to the State of California to cause cancer and birth defects or other reproductive harm. To minimize exposure, avoid breathing exhaust, do not idle the engine except as necessary, service your vehicle in a well-ventilated area and wear gloves or wash your hands frequently when servicing your vehicle. For more information go to [www.P65Warnings.ca.gov/passenger-vehicle](http://www.P65Warnings.ca.gov/passenger-vehicle).



# TABLE OF CONTENTS

1	INTRODUCTION.....	8
2	GETTING TO KNOW YOUR VEHICLE .....	13
3	GETTING TO KNOW YOUR INSTRUMENT PANEL .....	61
4	STARTING AND OPERATING .....	78
5	MULTIMEDIA .....	119
6	SAFETY .....	179
7	IN CASE OF EMERGENCY .....	230
8	SERVICING AND MAINTENANCE .....	251
9	TECHNICAL SPECIFICATIONS .....	307
10	CUSTOMER ASSISTANCE .....	315
11	INDEX.....	319

1

2

3

4

5

6

7

8

9

10

11

## INTRODUCTION

<b>SYMBOLS KEY</b> .....	9
<b>VEHICLE MODIFICATIONS/ALTERATIONS</b> .....	9
<b>SYMBOL GLOSSARY</b> .....	10

## GETTING TO KNOW YOUR VEHICLE

<b>KEYS</b> .....	13
Key Fob .....	13
<b>SENTRY KEY</b> .....	16
<b>IGNITION SWITCH</b> .....	16
Keyless Enter 'n Go™ Ignition .....	16
<b>REMOTE START — IF EQUIPPED</b> .....	17
How To Use Remote Start.....	18
To Exit Remote Start Mode.....	19
Remote Start Front Defrost Activation — If Equipped.....	19
Remote Start Comfort Systems — If Equipped.....	19
Remote Start Cancel Message — If Equipped.....	20
<b>VEHICLE SECURITY SYSTEM — IF EQUIPPED</b> .....	20
To Arm The System .....	20
To Disarm The System .....	20
Rearming The System.....	21
Security System Manual Override .....	21
Tamper Alert .....	21

<b>DOORS</b> .....	21
Manual Door Locks .....	21
Power Door Locks .....	22
Keyless Enter 'n Go™ — Passive Entry.....	22
Automatic Unlock Doors On Exit .....	24
Automatic Door Locks — If Equipped .....	25
<b>STEERING WHEEL</b> .....	25
Manual Tilt/Telescoping Steering	
Column — If Equipped.....	25
Power Tilt/Telescoping Steering	
Column — If Equipped .....	25
Heated Steering Wheel — If Equipped .....	26
<b>UNCONNECT VOICE RECOGNITION</b> .....	26
Introducing Voice Recognition.....	26
Basic Voice Commands .....	27
Get Started .....	27
Additional Information .....	27
<b>DRIVER MEMORY SETTINGS — IF EQUIPPED</b> .....	28
Programming The Memory Feature .....	28
Linking And Unlinking The Key Fob	
To Memory.....	29
Memory Position Recall .....	29
<b>SEATS</b> .....	29
Manual Adjustment (Front Seats) — If Equipped.....	30
Manual Adjustment (Rear Seats).....	31
Power Adjustment (Front Seats) — If Equipped.....	32

Heated Seats — If Equipped .....	33
Front Ventilated Seats — If Equipped .....	34
Vehicles Without Passenger Seating Installed .....	34
Passenger Seat Easy Entry.....	34
Head Restraints .....	35
<b>MIRRORS</b> .....	36
Inside Rearview Mirror.....	36
Illuminated Vanity Mirrors .....	37
Outside Mirrors .....	37
Power Mirrors .....	38
Heated Mirrors — If Equipped .....	38
<b>UNIVERSAL GARAGE DOOR OPENER (HOMELINK®)</b> .....	38
Before You Begin Programming	
HomeLink® .....	38
Erasing All The HomeLink® Channels.....	39
Identifying Whether You Have A Rolling Code Or Non-Rolling Code Device.....	39
Programming HomeLink® To A Garage Door Opener.....	39
Programming HomeLink® To A Miscellaneous Device.....	40
Reprogramming A Single HomeLink® Button .....	40
Canadian/Gate Operator Programming .....	41



<b>EXTERIOR LIGHTS</b> .....	<b>41</b>	<b>INTERIOR STORAGE AND EQUIPMENT</b> .....	<b>53</b>	Performance Shift Indicator (PSI) –	
Headlight Switch .....	41	Storage.....	53	If Equipped .....	65
Multifunction Lever .....	42	Illuminated Cupholders – If Equipped.....	53	Instrument Cluster Display Selectable	
Daytime Running Lights (DRLs) –		USB/AUX Control .....	54	Menu Items .....	65
If Equipped .....	42	Power Outlets .....	54	Battery Saver On/Battery Saver Mode	
High/Low Beam Switch .....	42	<b>WINDOWS</b> .....	<b>56</b>	Message – Electrical Load Reduction	
Automatic High Beam Headlamp		Power Window Controls.....	56	Actions – If Equipped .....	68
Control – If Equipped .....	43	Wind Buffeting.....	56	<b>WARNING LIGHTS AND MESSAGES</b> .....	<b>69</b>
Flash-To-Pass .....	43	<b>POWER SUNROOF – IF EQUIPPED</b> .....	<b>56</b>	Red Warning Lights.....	69
Automatic Headlights .....	43	Opening And Closing The Sunroof.....	57	Yellow Warning Lights.....	72
Parking Lights .....	43	Pinch Protect Feature – If Equipped .....	57	Yellow Indicator Lights.....	75
Automatic Headlights With Wipers.....	43	Venting Sunroof.....	57	Green Indicator Lights .....	75
Headlight Time Delay .....	44	Sunshade Operation .....	57	White Indicator Lights.....	76
Lights-On Reminder .....	44	Sunroof Maintenance .....	58	Blue Indicator Lights.....	76
Fog Lights – If Equipped .....	44	Ignition Off Operation.....	58	<b>ONBOARD DIAGNOSTIC SYSTEM – OBD II</b> .....	<b>76</b>
Turn Signals.....	44	<b>HOOD</b> .....	<b>58</b>	Onboard Diagnostic System (OBD II)	
Lane Change Assist – If Equipped .....	44	Opening The Hood .....	58	Cybersecurity.....	76
<b>INTERIOR LIGHTS</b> .....	<b>45</b>	Closing The Hood .....	59	<b>EMISSIONS INSPECTION AND MAINTENANCE</b>	
Front Map/Reading Lights .....	45	<b>TRUNK</b> .....	<b>59</b>	<b>PROGRAMS</b> .....	<b>77</b>
Ambient Light – If Equipped.....	45	Opening The Trunk.....	59		
Dimmer Control .....	46	Closing The Trunk.....	60		
<b>WINDSHIELD WIPERS AND WASHERS</b> .....	<b>46</b>	Trunk Safety .....	60		
Windshield Wiper Operation.....	47				
Rain Sensing Wipers – If Equipped .....	48				
<b>CLIMATE CONTROLS</b> .....	<b>48</b>				
Automatic Climate Control Descriptions					
And Functions .....	48				
Automatic Temperature Control (ATC) .....	51				
Climate – Voice Recognition .....	52				
Operating Tips .....	52				
		<b>GETTING TO KNOW YOUR</b>			
		<b>INSTRUMENT PANEL</b>			
		<b>INSTRUMENT CLUSTER</b> .....	<b>61</b>	<b>STARTING THE ENGINE</b> .....	<b>78</b>
		Instrument Cluster Descriptions .....	62	Manual Transmission – If Equipped.....	78
		<b>INSTRUMENT CLUSTER DISPLAY</b> .....	<b>62</b>	Automatic Transmission – If Equipped .....	78
		Location And Controls.....	63	Normal Starting.....	79
		Engine Oil Life Reset .....	64	AutoPark .....	80
				Cold Weather Operation	
				(Below -22°F Or -30°C) .....	81
				If Engine Fails To Start .....	81
				After Starting .....	81

ENGINE BLOCK HEATER — IF EQUIPPED .....	81	PARKSENSE REAR PARK ASSIST —		RECREATIONAL TOWING	
ENGINE BREAK-IN RECOMMENDATIONS —		IF EQUIPPED .....	103	(BEHIND MOTORHOME) .....	116
3.6L & 5.7L .....	82	ParkSense Sensors .....	103	DRIVING TIPS .....	117
PARKING BRAKE .....	82	ParkSense Display .....	103	Driving On Slippery Surfaces.....	117
MANUAL TRANSMISSION — IF EQUIPPED .....	83	ParkSense Warning Display .....	105	Driving Through Water .....	117
Six-Speed Manual Transmission .....	83	Enabling And Disabling ParkSense.....	105		
Shifting .....	84	Service The ParkSense Rear Park			
Recommended Shift Speeds.....	85	Assist System .....	106		
1-4 Skip Shift .....	85	Cleaning The ParkSense System .....	106		
Downshifting.....	86	ParkSense System Usage Precautions.....	106		
AUTOMATIC TRANSMISSION —		PARKVIEW REAR BACK UP CAMERA .....	107	MULTIMEDIA	
IF EQUIPPED .....	86	REFUELING THE VEHICLE .....	108	UCONNECT SYSTEMS .....	119
Ignition Park Interlock.....	87	Loose Fuel Filler Cap Message .....	109	CYBERSECURITY .....	119
Brake Transmission Shift Interlock (BTSI)		VEHICLE LOADING .....	109	UCONNECT SETTINGS .....	120
System .....	87	Vehicle Certification Label .....	109	Customer Programmable Features .....	120
Eight-Speed Automatic Transmission .....	87	Gross Vehicle Weight Rating (GVWR) .....	109	UCONNECT INTRODUCTION.....	134
SPORT MODE — WITHOUT PERFORMANCE		Gross Axle Weight Rating (GAWR) .....	109	System Overview .....	134
CONTROL .....	92	Overloading.....	109	Drag & Drop Menu Bar .....	136
FUEL SAVER TECHNOLOGY 5.7L —		Loading .....	110	Safety And General Information .....	136
IF EQUIPPED.....	92	TRAILER TOWING.....	110	UCONNECT MODES .....	137
ELECTRIC POWER STEERING.....	92	Common Towing Definitions.....	110	Steering Wheel Audio Controls.....	137
CRUISE CONTROL SYSTEMS — IF EQUIPPED.....	93	Trailer Hitch Classification.....	112	Radio Mode .....	138
Cruise Control .....	93	Trailer Towing Weights		Media Mode .....	147
Adaptive Cruise Control (ACC) .....	95	(Maximum Trailer Weight Ratings) .....	112	Phone Mode .....	149
		Trailer And Tongue Weight .....	113	ANDROID AUTO™ & APPLE CARPLAY® —	
		Towing Requirements .....	113	IF EQUIPPED .....	160
		Towing Tips .....	116	Android Auto™ .....	160
				Apple CarPlay® .....	162
				Android Auto™ And Apple CarPlay®	
				Tips And Tricks .....	164

<b>PERFORMANCE PAGES</b> .....	<b>164</b>	<b>OCCUPANT RESTRAINT SYSTEMS</b> .....	<b>194</b>	<b>TIRE SERVICE KIT — IF EQUIPPED</b> .....	<b>238</b>
Home .....	165	Occupant Restraint Systems Features .....	194	Tire Service Kit Storage .....	238
Timers .....	168	Important Safety Precautions .....	195	Tire Service Kit Components And	
Gauges .....	170	Seat Belt Systems .....	195	Operation .....	238
G-Force .....	171	Supplemental Restraint Systems (SRS) .....	202	Tire Service Kit Usage Precautions .....	239
Engine .....	172	Child Restraints .....	211	Sealing A Tire With Tire Service Kit .....	240
Dynamometer (Dyno) .....	172	<b>SAFETY TIPS</b> .....	<b>226</b>	<b>JUMP STARTING</b> .....	<b>243</b>
<b>DODGE DRIVE MODES — IF EQUIPPED</b> .....	<b>173</b>	Transporting Passengers .....	226	Preparations For Jump Start .....	244
Performance Control — If Equipped .....	173	Transporting Pets .....	226	Jump Starting Procedure .....	244
<b>RADIO OPERATION AND MOBILE PHONES</b> .....	<b>178</b>	Safety Checks You Should Make		<b>IF YOUR ENGINE OVERHEATS</b> .....	<b>245</b>
Regulatory And Safety Information .....	178	Inside The Vehicle .....	226	<b>MANUAL PARK RELEASE - 8 - SPEED</b>	
<b>SAFETY</b>		Periodic Safety Checks You Should		<b>TRANSMISSION</b> .....	<b>246</b>
<b>SAFETY FEATURES</b> .....	<b>179</b>	Make Outside The Vehicle .....	228	<b>FREEDING A STUCK VEHICLE</b> .....	<b>248</b>
Anti-Lock Brake System (ABS) .....	179	Exhaust Gas .....	229	<b>TOWING A DISABLED VEHICLE</b> .....	<b>249</b>
Electronic Brake Control (EBC) System .....	180	Carbon Monoxide Warnings .....	229	Rear-Wheel Drive (RWD) Models .....	250
<b>AUXILIARY DRIVING SYSTEMS</b> .....	<b>185</b>	<b>IN CASE OF EMERGENCY</b>		<b>ENHANCED ACCIDENT RESPONSE</b>	
Blind Spot Monitoring (BSM) —		<b>HAZARD WARNING FLASHERS</b> .....	<b>230</b>	<b>SYSTEM (EARS)</b> .....	<b>250</b>
If Equipped .....	185	<b>ASSIST AND SOS MIRROR — IF EQUIPPED</b> .....	<b>230</b>	<b>EVENT DATA RECORDER (EDR)</b> .....	<b>250</b>
Forward Collision Warning (FCW)		<b>JACKING AND TIRE CHANGING</b> .....	<b>234</b>		
Operation — If Equipped .....	189	Preparations For Jacking .....	234		
Tire Pressure Monitoring System (TPMS) .....	191	Jack Location/Spare Tire Stowage .....	234		
		Jacking And Changing A Tire .....	235		

## SERVICING AND MAINTENANCE

<b>SCHEDULED SERVICING</b> .....	<b>251</b>
3.6L And 5.7L Engines .....	251
<b>ENGINE COMPARTMENT</b> .....	<b>256</b>
3.6L Engine .....	256
5.7L Engine .....	257
Checking Oil Level .....	258
Adding Washer Fluid .....	258
Maintenance-Free Battery .....	259
Pressure Washing .....	259
<b>VEHICLE MAINTENANCE</b> .....	<b>260</b>
Engine Oil .....	260
Engine Oil Filter .....	261
Engine Air Cleaner Filter .....	262
Air Conditioner Maintenance .....	263
Accessory Drive Belt Inspection .....	264
Body Lubrication .....	265
Windshield Wiper Blades .....	265
Exhaust System .....	267
Cooling System .....	268
Brake System .....	271

Clutch Hydraulic System – Manual	
Transmission (If Equipped).....	272
Manual Transmission – If Equipped.....	272
Automatic Transmission – If Equipped .....	272
All Wheel Drive (AWD) – If Equipped .....	273
Rear Axle.....	273
Fuses.....	274
Bulb Replacement .....	282
<b>TIRES</b> .....	<b>285</b>
Tire Safety Information .....	285
Tires – General Information .....	293
Tire Types.....	297
Spare Tires – If Equipped.....	297
Wheel And Wheel Trim Care.....	299
Snow Traction Devices .....	300
Tire Rotation Recommendations .....	302
<b>DEPARTMENT OF TRANSPORTATION</b>	
<b>UNIFORM TIRE QUALITY GRADES</b> .....	<b>302</b>
Treadwear.....	303
Traction Grades.....	303
Temperature Grades.....	303
<b>VEHICLE STORAGE</b> .....	<b>303</b>

<b>BODYWORK</b> .....	<b>304</b>
Protection From Atmospheric Agents .....	304
Body And Underbody Maintenance .....	304
Preserving The Bodywork .....	304
<b>INTERIORS</b> .....	<b>305</b>
Seats And Fabric Parts .....	305
Plastic And Coated Parts .....	306
Leather Surfaces.....	306
Glass Surfaces .....	306

## TECHNICAL SPECIFICATIONS

<b>VEHICLE IDENTIFICATION NUMBER (VIN)</b> .....	<b>307</b>
<b>BRAKE SYSTEM</b> .....	<b>307</b>
<b>WHEEL AND TIRE TORQUE</b>	
<b>SPECIFICATIONS</b> .....	<b>307</b>
Torque Specifications .....	307
<b>FUEL REQUIREMENTS</b> .....	<b>308</b>
3.6L Engine .....	308
5.7L Engine	
(With Automatic Transmission).....	308
5.7L Engine (With Manual Transmission) ...	309

Reformulated Gasoline .....	309
Materials Added To Fuel .....	309
Gasoline/Oxygenate Blends .....	309
Do Not Use E-85 In Non-Flex Fuel Vehicles.....	310
CNG And LP Fuel System Modifications .....	310
Methylcyclopentadienyl Manganese Tricarbonyl (MMT) In Gasoline.....	310
Fuel System Cautions .....	310
<b>FLUID CAPACITIES .....</b>	<b>311</b>
<b>ENGINE FLUIDS AND LUBRICANTS .....</b>	<b>312</b>
<b>CHASSIS FLUIDS AND LUBRICANTS .....</b>	<b>314</b>

## CUSTOMER ASSISTANCE

### SUGGESTIONS FOR OBTAINING SERVICE

<b>FOR YOUR VEHICLE .....</b>	<b>315</b>
Prepare For The Appointment .....	315
Prepare A List .....	315
Be Reasonable With Requests.....	315
<b>IF YOU NEED ASSISTANCE.....</b>	<b>315</b>
FCA US LLC Customer Center.....	315
FCA Canada Inc. Customer Center.....	315
Mexico.....	316
Puerto Rico And US Virgin Islands.....	316
Customer Assistance For The Hearing Or Speech Impaired (TDD/TTY).....	316
Service Contract .....	316

<b>WARRANTY INFORMATION.....</b>	<b>317</b>
<b>MOPAR® PARTS .....</b>	<b>317</b>
<b>REPORTING SAFETY DEFECTS .....</b>	<b>317</b>
In The 50 United States And Washington, D.C.....	317
In Canada .....	317
<b>PUBLICATION ORDER FORMS .....</b>	<b>318</b>
<b>GENERAL INFORMATION.....</b>	<b>318</b>

# INTRODUCTION



Dear Customer,

Congratulations on the purchase of your new Dodge vehicle. Be assured that it represents precision workmanship, distinctive styling, and high quality. This Owner's Manual has been prepared with the assistance of service and engineering specialists to acquaint you with the operation and maintenance of your vehicle. It is supplemented by customer-oriented documents. Within this information, you will find a description of the services that FCA US LLC offers to its customers as well as the details of the terms and conditions for maintaining its validity. Please take the time to read all of these publications carefully before driving your vehicle for the first time. Following the instructions, recommendations, tips, and important warnings in this manual will help ensure safe and enjoyable operation of your vehicle.

This Owner's Manual describes all versions of this vehicle. Options and equipment dedicated to specific markets or versions are not expressly indicated in the text. Therefore, you should only consider the information that is related to the trim level, engine, and version that you have purchased. Any content introduced throughout the Owner's Information, which may or may not be applicable to your vehicle, will be identified with the wording "If Equipped". All data contained in this publication are intended to help you use your vehicle in the best possible way. FCA US LLC aims at a constant improvement of the vehicles produced. For this reason, it reserves the right to make changes to the model described for technical and/or commercial reasons. For further information, contact an authorized dealer.

When it comes to service, remember that authorized dealers know your Dodge best, have factory-trained technicians, genuine Mopar® parts, and care about your satisfaction.

## SYMBOLS KEY

<b>WARNING!</b>	These statements apply to operating procedures that could result in a collision, bodily injury and/or death.
<b>CAUTION!</b>	These statements apply to procedures that could result in damage to your vehicle.
<b>NOTE:</b>	A suggestion which will improve installation, operation, and reliability. If not followed, may result in damage.
<b>TIP:</b>	General ideas/solutions/suggestions on easier use of the product or functionality.
<b>PAGE REFERENCE ARROW</b> 	Follow this reference for additional information on a particular feature.
<b>FOOTNOTE</b> 	Supplementary and relevant information pertaining to the topic.

If you do not read this entire Owner's Manual, you may miss important information. Observe all Cautions and Warnings.

## VEHICLE MODIFICATIONS/ALTERATIONS

<b>WARNING!</b>
Any modifications or alterations to this vehicle could seriously affect its roadworthiness and safety and may lead to a collision resulting in serious injury or death.

<b>WARNING!</b>
To prevent <b>SERIOUS INJURY</b> or <b>DEATH</b> when using "Track-Use" parts and equipment:
<ul style="list-style-type: none"> <li>● NEVER use any "Track-Use" equipment on public roads. FCA US LLC does not authorize the use of "Track-Use" equipment on public roads.</li> <li>● The intended use of "Track-Use" parts is for race vehicles on race tracks. To help ensure the safety of the race driver, engineers should supervise the installation of "Track-Use" parts.</li> <li>● FCA US LLC does not authorize the installation or use of any part noted as "Track-Use" on any new vehicle prior to its first retail sale.</li> </ul>

**WARNING!**

To prevent SERIOUS INJURY or DEATH:

- ALWAYS remove any “Track-Use” equipment before driving on public roads.
- ALWAYS properly use your three-point seat belts when driving on public roads.
- In a collision, you and your passengers can suffer much greater injuries if you are not properly buckled up. You can strike the interior of your vehicle or other passengers, or you can be thrown out of the vehicle.

**SYMBOL GLOSSARY**

Some car components have colored labels with symbols indicating precautions to be observed when using this component. It is important to follow all warnings when operating your vehicle. See below for the definition of each symbol → page 69.

**NOTE:**

Warning and Indicator lights are different based upon equipment options and current vehicle status. Some telltales are optional and may not appear.

**Red Warning Lights**

Air Bag Warning Light  
→ page 69

**Red Warning Lights**

Brake Warning Light  
→ page 70



Battery Charge Warning Light  
→ page 70



Door Open Warning Light  
→ page 71



Oil Pressure Warning Light  
→ page 71



Oil Temperature Warning Light  
→ page 72



Seat Belt Reminder Warning Light  
→ page 70









Electronic Throttle Control (ETC) Warning Light  
→ page 71





Engine Coolant Temperature Warning Light  
→ page 71



Red Warning Lights	
	Transmission Temperature Warning Light ⇨ page 72
	Electric Power Steering (EPS) Fault Warning Light ⇨ page 71
	Trunk Open Warning Light ⇨ page 71
	Vehicle Security Warning Light ⇨ page 72

Yellow Warning Lights	
	Engine Check/Malfunction Indicator Warning Light (MIL) ⇨ page 73
	Electronic Stability Control (ESC) Active Warning Light ⇨ page 72
	Electronic Stability Control (ESC) OFF Warning Light ⇨ page 73

Yellow Warning Lights	
	Tire Pressure Monitoring System (TPMS) Warning Light ⇨ page 74
	Anti-Lock Brake System (ABS) Warning Light ⇨ page 72
	Low Fuel Warning Light ⇨ page 73
	Service Forward Collision Warning (FCW) Light ⇨ page 74
	Loose Fuel Filler Cap Warning Light ⇨ page 73
	Service AWD Warning Light ⇨ page 74
	Service Adaptive Cruise Control Warning Light ⇨ page 72

### Yellow Indicator Lights



Forward Collision Warning OFF Indicator Light  
 ⇨ page 75

### Green Indicator Lights



Adaptive Cruise Control (ACC) Set Without Target Vehicle Light  
 ⇨ page 75



Adaptive Cruise Control (ACC) Set With Target Vehicle Light  
 ⇨ page 75



Parking/Headlights On Indicator Light  
 ⇨ page 75



Front Fog Indicator Light  
 ⇨ page 75



Turn Signal Indicator Lights  
 ⇨ page 75



ECO Mode Indicator Light  
 ⇨ page 75

### Green Indicator Lights



Cruise Control Set Indicator Light  
 ⇨ page 75



Sport Mode Indicator Light  
 ⇨ page 75

### White Indicator Lights



Cruise Control Ready Indicator  
 ⇨ page 76



Adaptive Cruise Control (ACC) Ready Indicator Light  
 ⇨ page 76

### Blue Indicator Lights



High Beam Indicator Light  
 ⇨ page 76

# GETTING TO KNOW YOUR VEHICLE

## KEYS

### KEY FOB

Your vehicle is equipped with a key fob which supports Passive Entry, Remote Keyless Entry (RKE), Keyless Enter 'n Go™ (if equipped), Remote Start (if equipped), and remote trunk operation. The key fob allows you to lock or unlock the doors and trunk from distances up to approximately 66 ft (20 m). The key fob does not need to be pointed at the vehicle to activate the system. The key fob also contains an emergency key, which is stored in the rear of the key fob.

#### NOTE:

- The key fob's wireless signal may be blocked if the key fob is located next to a mobile phone, laptop, or other electronic device. This may result in poor performance.
- With ignition in the ON position and the vehicle moving at 2 mph (4 km/h), all RKE commands are disabled.



Key Fob

- 1 – Unlock
- 2 – Trunk Open
- 3 – Lock
- 4 – Remote Start (If Equipped)
- 5 – PANIC Button
- 6 – Emergency Key

#### NOTE:

In case the ignition switch does not change with the push of a button, the key fob may have a low or fully depleted battery. A low key fob battery can be verified by referring to the instrument cluster, which will display directions to follow → page 318.

### To Lock/Unlock The Doors And Trunk

Push and release the unlock button on the key fob once to unlock the driver's door or twice within five seconds to unlock all doors. Push and release the lock button on the key fob to lock all doors.

When the doors are unlocked, the turn signals will flash and the illuminated entry system will be activated. When the doors are locked, the turn signals will flash and the horn will chirp. This setting can be adjusted in the Uconnect system → page 120.

#### NOTE:

- If the vehicle is unlocked with the key fob, and no door is opened within 60 seconds, the vehicle will relock and the security system will arm (if equipped).
- If one or more doors are open, or the trunk is open, the doors will lock. The doors will unlock again automatically if the key fob is left inside the passenger compartment, otherwise the doors will stay locked.

All doors can be programmed to unlock on the first push of the unlock button through Uconnect Settings → page 120.

### NOTE:

When you use the key fob to open any door, the courtesy lights, overhead lights, and approach lighting in the outside mirrors (if equipped) will turn on → page 45.

### To Unlatch The Trunk

Push the trunk button on the key fob two times within five seconds to unlatch the trunk.

### Replacing The Battery In The Key Fob

The recommended replacement battery is one CR2032 battery.

### NOTE:

- Customers are recommended to use a battery obtained from Mopar®. Aftermarket coin battery dimensions may not meet the original OEM coin battery dimensions.
- Perchlorate Material — special handling may apply. See [www.dtsc.ca.gov/hazardouswaste/perchlorate](http://www.dtsc.ca.gov/hazardouswaste/perchlorate) for further information.
- Do not touch the battery terminals that are on the back housing or the printed circuit board.

1. Remove the emergency key (2) by sliding the emergency key release (1) on the back of the key fob and pulling the emergency key out with your other hand.

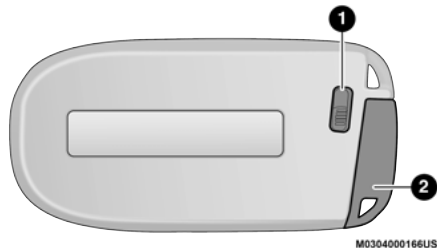

**Emergency Key Removal**

- 1 – Emergency Key Release Button  
2 – Emergency Key

2. Separate the key fob halves using a #2 flat blade screwdriver or a coin, and gently pry the two halves of the key fob apart. Make sure not to damage the seal during removal.

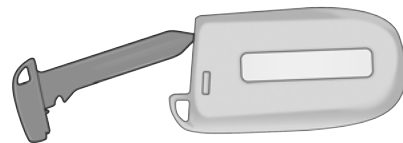

A0204000053US

**Emergency Key Removal**

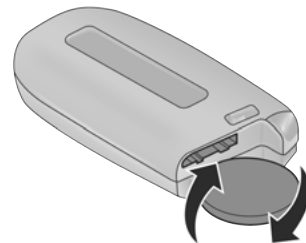

M0304000167US

**Separating Case With A Coin**

**NOTE:**

Separating the case can also be done with a flat head screwdriver.

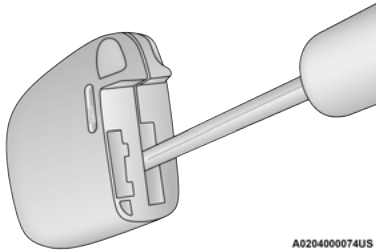

Separating Case With A Flat Blade Screwdriver

A020400074US

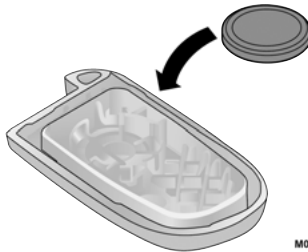

Key Fob Battery Replacement

M0304000168US

- Remove the back cover to access and replace the battery. When replacing the battery, match the (+) sign on the battery to the (+) sign on the inside of the battery clip, located on the back cover. Avoid touching the new battery with your fingers. Skin oils may cause battery deterioration. If you touch a battery, clean it with rubbing alcohol.
- To assemble the key fob case, snap the two halves together.

**WARNING!**

- The integrated key fob contains a coin cell battery. Do not ingest the battery; there is a chemical burn hazard. If the coin cell battery is swallowed, it can cause severe internal burns in just two hours and can lead to death.
- If you think a battery may have been swallowed or placed inside any part of the body, seek immediate medical attention.
- Keep new and used batteries away from children. If the battery compartment does not close securely, stop using the product and keep it away from children.

**Programming And Requesting Additional Key Fobs**

Programming the key fob may be performed by an authorized dealer.

**NOTE:**

- Once a key fob is programmed to a vehicle, it cannot be repurposed and reprogrammed to another vehicle.
- Only key fobs that are programmed to the vehicle electronics can be used to start and operate the vehicle.

**WARNING!**

- Always remove the key fobs from the vehicle and lock all doors when leaving the vehicle unattended.
- For vehicles equipped with Keyless Enter 'n Go™ Ignition, always remember to place the ignition in the OFF position.

Duplication of key fobs may be performed at an authorized dealer. This procedure consists of programming a blank key fob to the vehicle electronics.

**NOTE:**

When having the Sentry Key Immobilizer system serviced, bring all vehicle keys with you to an authorized dealer.

## SENTRY KEY

The Sentry Key Immobilizer system prevents unauthorized vehicle operation by disabling the engine. The system does not need to be armed or activated. Operation is automatic, regardless of whether the vehicle is locked or unlocked.

The system uses a key fob, keyless push button ignition and a Radio Frequency (RF) receiver to prevent unauthorized vehicle operation. Therefore, only key fobs that are programmed to the vehicle can be used to start and operate the vehicle. The system cannot reprogram a key fob obtained from another vehicle.

After placing the ignition switch in the ON/RUN position, the Vehicle Security Light will turn on for three seconds for a bulb check. If the light remains on after the bulb check, it indicates that there is a problem with the electronics. In addition, if the light begins to flash after the bulb check, it indicates that someone attempted to start the engine with an invalid key fob. In the event that a valid key fob is used to start the engine but there is an issue with the vehicle electronics, the engine will start and shut off after two seconds.

If the Vehicle Security Light turns on during normal vehicle operation (vehicle running for longer than 10 seconds), it indicates that there is a fault in the

electronics. Should this occur, have the vehicle serviced as soon as possible by an authorized dealer.

### CAUTION!

The Sentry Key Immobilizer system is not compatible with some aftermarket Remote Start systems. Use of these systems may result in vehicle starting problems and loss of security protection.

All of the key fobs provided with your new vehicle have been programmed to the vehicle electronics  
 ↪ page 318.

## IGNITION SWITCH

### KEYLESS ENTER 'N GO™ IGNITION

This feature allows the driver to operate the ignition switch with the push of a button as long as the key fob is in the passenger compartment.

The START/STOP ignition button has four operating positions, three of which are labeled and will illuminate when in position. The three positions are OFF, ACC, and ON/RUN. The fourth position is START. During START, RUN will illuminate.

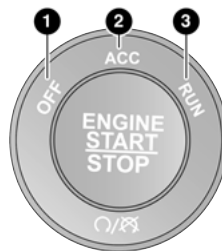

A0205000012US

**START/STOP Ignition Button**

- 1 — OFF
- 2 — ACC
- 3 — ON/RUN

The push button ignition can be placed in the following modes:

#### OFF

- The engine is stopped.
- Some electrical devices (e.g. power locks, alarm, etc.) are still available.

#### ACC

- Engine is not started.
- Some electrical devices are available (e.g. power windows, etc.).

**ON/RUN**

- Driving position.
- All the electrical devices are available (e.g. climate controls, etc.).

**START**

- The engine will start.

**NOTE:**

If the ignition switch does not change with the push of a button, the key fob may have a low or depleted battery. In this situation, a backup method can be used to operate the ignition switch. Put the nose side (side opposite of the emergency key) of the key fob against the START/STOP ignition button and push to operate the ignition switch.

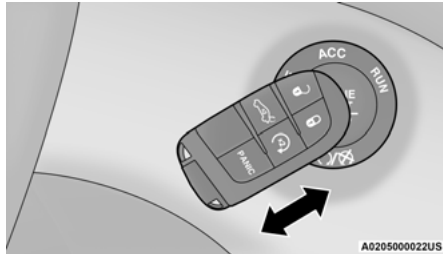

**Depleted Key Fob Battery Procedure**

**WARNING!**

- When exiting the vehicle, always remove the key fob from the vehicle and lock your vehicle.
- Never leave children alone in a vehicle, or with access to an unlocked vehicle.
- Allowing children to be in a vehicle unattended is dangerous for a number of reasons. A child or others could be seriously or fatally injured. Children should be warned not to touch the parking brake, brake pedal or the gear selector.
- Do not leave the key fob in or near the vehicle, or in a location accessible to children, and do not leave the ignition of a vehicle equipped with Keyless Enter 'n Go™ in the ON/RUN position. A child could operate power windows, other controls, or move the vehicle.
- Do not leave children or animals inside parked vehicles in hot weather. Interior heat buildup may cause serious injury or death.

**CAUTION!**

An unlocked vehicle is an invitation for thieves. Always remove key fob from the vehicle and lock all doors when leaving the vehicle unattended.

2

**NOTE:**

- When opening the driver's door with the ignition in ON/RUN (engine not running), a chime will sound to remind you to place the ignition in the OFF position. In addition to the chime, the message will display "Ignition Or Accessory On" in the cluster.
- For more information on proper engine starting procedures, see [page 78](#).

**REMOTE START — IF EQUIPPED**

This system uses the key fob to start the engine conveniently from outside the vehicle while still maintaining security. The system has a range of 328 ft (100 m).

Remote Start is used to defrost windows in cold weather, and to reach a comfortable climate in all ambient conditions before the driver enters the vehicle.

**NOTE:**

Obstructions between the vehicle and key fob may reduce this range → page 318.

**WARNING!**

- Do not start or run an engine in a closed garage or confined area. Exhaust gas contains carbon monoxide (CO) which is odorless and colorless. Carbon monoxide is poisonous and can cause serious injury or death when inhaled.
- Keep key fobs away from children. Operation of the Remote Start system, windows, door locks or other controls could cause serious injury or death.

**HOW TO USE REMOTE START**

Push and release the Remote Start button on the key fob twice within five seconds. The vehicle doors will lock, the parking lights will flash, and the horn will chirp twice (if programmed). Then, the engine will start, and the vehicle will remain in the Remote Start mode for a 15 minute cycle. Pushing the Remote Start button a third time shuts the engine off.

To drive the vehicle, push the unlock button, and place the ignition in the ON/RUN position.

**NOTE:**

- With Remote Start, the engine will only run for 15 minutes.
- Remote Start can only be used twice.
- If an engine fault is present or fuel level is low, the vehicle will start and then shut down in 10 seconds.
- The park lamps will turn on and remain on during Remote Start mode.
- For security, power window and power sunroof operation (if equipped) are disabled when the vehicle is in the Remote Start mode.
- The ignition must be placed in the ON/RUN position before the Remote Start sequence can be repeated for a third cycle.

All of the following conditions must be met before the engine will remote start:

- Gear selector in PARK
- Doors closed
- Hood closed
- Trunk closed
- Hazard switch off

- Brake switch inactive (brake pedal not pressed)
- Battery at an acceptable charge level
- PANIC button not pushed
- System not disabled from previous Remote Start event
- Vehicle Security system indicator flashing
- Ignition in the OFF position
- Fuel level meets minimum requirement
- Vehicle Security system is not signaling an intrusion
- Malfunction Indicator Light is not illuminated

**WARNING!**

- Do not start or run an engine in a closed garage or confined area. Exhaust gas contains carbon monoxide (CO) which is odorless and colorless. Carbon monoxide is poisonous and can cause serious injury or death when inhaled.
- Keep key fobs away from children. Operation of the Remote Start system, windows, door locks or other controls could cause serious injury or death.



## TO EXIT REMOTE START MODE

To drive the vehicle after starting the Remote Start system, either push and release the unlock button on the key fob to unlock the doors, or unlock the vehicle using Keyless Enter 'n Go™ — Passive Entry via the door handles, and disarm the Vehicle Security system (if equipped). Then, prior to the end of the 15 minute cycle, push and release the START/STOP ignition button.

The Remote Start system will turn the engine off with another push and release of the Remote Start button on the key fob, or if the engine is allowed to run for the entire 15 minute cycle. Once the ignition is placed in the ON/RUN position, the climate controls will resume the previously set operations (temperature, blower control, etc.).

### NOTE:

- To avoid unintentional shutdowns, the system will disable for two seconds after receiving a valid Remote Start request.
- For vehicles equipped with the Keyless Enter 'n Go™ — Passive Entry feature, the message “Remote Start Active — Push Start Button” will show in the instrument cluster display until you push the START/STOP ignition button.

Remote Start will also cancel if any of the following occur:

- The engine stalls or engine speed exceeds 2500 RPM.
- Any engine warning lights come on.
- The Low Fuel Light turns on.
- The hood is opened.
- The hazard switch is pushed.
- The gear selector is moved out of PARK.
- The brake pedal is pressed.

## REMOTE START FRONT DEFROST ACTIVATION — IF EQUIPPED

When Remote Start is active, and the outside ambient temperature is 40°F (4.5°C) or below, the system will automatically activate front defrost for 15 minutes or less. The time is dependent on the ambient temperature. Once the timer expires, the system will automatically adjust the settings depending on ambient conditions. See “Remote Start Comfort Systems — If Equipped” in the next section for detailed operation.

## REMOTE START COMFORT SYSTEMS — IF EQUIPPED

When Remote Start is activated, the front and rear defrost will automatically turn on in cold weather. The heated steering wheel and driver heated seat feature will turn on if selected in the Comfort menu screen within Uconnect Settings ↻ page 120. In warm weather, the driver vented seat feature will automatically turn on when Remote Start is activated, if programmed in the Comfort menu screen. The vehicle will adjust the climate control settings depending on the outside ambient temperature.

### Automatic Temperature Control (ATC) — If Equipped

The climate controls will be automatically adjusted to the optimal temperature and mode settings depending on the outside ambient temperature. This will occur until the ignition is placed in the ON/RUN position where the climate controls will resume their previous settings.

**Manual Temperature Control (MTC) — If Equipped**

- In ambient temperatures at 40°F (4.5°C) or below, the climate settings will default to maximum heat, with fresh air entering the cabin. If the front defrost timer expires, the vehicle will enter Mix Mode.
- In ambient temperatures from 40°F (4.5°C) to 78°F (26°C), the climate settings will be based on the last settings selected by the driver.
- In ambient temperatures at 78°F (26°C) or above, the climate settings will default to MAX A/C, Bi-Level Mode, with Recirculation on.

For more information on ATC, MTC, and climate control settings, see ⇨ page 48.

**NOTE:**

These features will stay on through the duration of Remote Start until the ignition is placed in the ON/RUN position. The climate control settings will change if manually adjusted by the driver while the vehicle is in Remote Start mode, and exit automatic override. This includes the OFF button on the climate controls, which will turn the system off.

**REMOTE START CANCEL MESSAGE — IF EQUIPPED**

One of the following messages will display in the instrument cluster display if the vehicle fails to remote start or exits Remote Start prematurely:

- Remote Start Cancelled — Door Open
- Remote Start Cancelled — Hood Open
- Remote Start Cancelled — Fuel Low
- Remote Start Cancelled — Trunk Open
- Remote Start Disabled — Start Vehicle To Reset

The message will stay active until the ignition is placed in the ON/RUN position.

**VEHICLE SECURITY SYSTEM — IF EQUIPPED**

The Vehicle Security system monitors the vehicle doors for unauthorized entry and the Keyless Enter 'n Go™ Ignition for unauthorized operation. While the Vehicle Security system is armed, interior switches for door locks and trunk release are disabled. If something triggers the alarm, the Vehicle Security system will provide the following audible and visible signals:

- The horn will pulse
- The turn signals will flash
- The Vehicle Security Light in the instrument cluster will flash

**TO ARM THE SYSTEM**

Follow these steps to arm the Vehicle Security system:

1. Make sure the vehicle's ignition is placed in the OFF position.
2. Perform one of the following methods to lock the vehicle:
  - Push lock on the interior power door lock switch with the driver and/or passenger door open.
  - Push the lock button on the exterior Passive Entry door handle with a valid key fob available in the same exterior zone ⇨ page 22.
  - Push the lock button on the key fob.
3. If any doors are open, close them.

**TO DISARM THE SYSTEM**

The Vehicle Security system can be disarmed using any of the following methods:

- Push the unlock button on the key fob.
- Grab the Passive Entry door handle to unlock the door ⇨ page 22.
- Push the START/STOP ignition button (requires at least one valid key fob in the vehicle).

**NOTE:**

- The driver's door key cylinder and the trunk button on the key fob cannot arm or disarm the Vehicle Security system.
- When the Vehicle Security system is armed, the interior power door lock switches will not unlock the doors.

The Vehicle Security system is designed to protect your vehicle. However, you can create conditions where the system will give you a false alarm. If one of the previously described arming sequences has occurred, the Vehicle Security system will arm, regardless of whether you are in the vehicle or not. If you remain in the vehicle and open a door, the alarm will sound. If this occurs, disarm the Vehicle Security system.

If the Vehicle Security system is armed and the battery becomes disconnected, the Vehicle Security system will remain armed when the battery is reconnected; the exterior lights will flash, and the horn will sound. If this occurs, disarm the Vehicle Security system.

**REARMING THE SYSTEM**

If something triggers the alarm and no action is taken to disarm it, the Vehicle Security system will turn the horn off after a 29 second cycle (with five seconds between cycles and up to eight cycles if the trigger remains active) and then rearm itself.

**SECURITY SYSTEM MANUAL OVERRIDE**

The Vehicle Security system will not arm if you lock the doors using the manual door lock.

**TAMPER ALERT**

If something has triggered the Vehicle Security system in your absence, the horn will sound three times and the exterior lights will blink three times when you disarm the Vehicle Security system.

**DOORS****MANUAL DOOR LOCKS**

The power door locks can be manually locked from inside the vehicle by using the door lock knob. To lock each door, push the door lock knob on each door trim panel downward. To unlock each door, pull the door lock knob on each door trim panel upward.

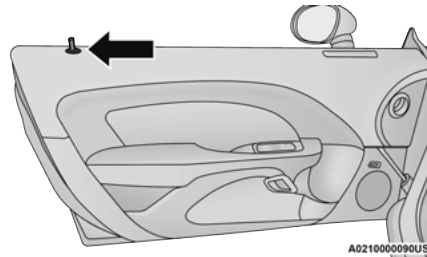

Door Lock Knob

If the door lock knob is down when you shut the door, the door will lock. Therefore, make sure the key fob is not inside the vehicle before closing the door.

**NOTE:**

Manually locking the vehicle will not arm the Vehicle Security system.

**WARNING!**

- For personal security and safety in the event of a collision, lock the vehicle doors before you drive as well as when you park and leave the vehicle.
- Before exiting a vehicle, always shift the automatic transmission into PARK or the manual transmission into FIRST gear or REVERSE, apply the parking brake, place the ignition in the OFF position, remove the key fobs from the vehicle and lock all doors, and lock your vehicle.
- When leaving the vehicle, always remove the key from the ignition and lock your vehicle. Unsupervised use of vehicle equipment may cause severe personal injuries and death.

(Continued)

**WARNING!**

- Never leave children alone in a vehicle, or with access to an unlocked vehicle. Allowing children to be in a vehicle unattended is dangerous for a number of reasons. A child or others could be seriously or fatally injured. Children should be warned not to touch the parking brake, brake pedal or gear selector.
- Do not leave the key fob in or near the vehicle, or in a location accessible to children, and do not leave the ignition of a vehicle equipped with Keyless Enter 'n Go™ in the ACC or ON/RUN position. A child could operate power windows, other controls, or move the vehicle.

**POWER DOOR LOCKS**

The power door lock switches are located on each door trim panel. Push the switch to lock or unlock the doors.

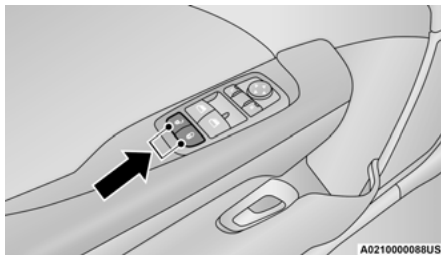
**Power Door Lock Switch**

If you push the power door lock switch while the ignition is on, and either door is open, the power locks will not operate. This prevents you from accidentally locking the key fob in the vehicle. Turning off the ignition or closing the door will allow the locks to operate.

**NOTE:**

If the key fob is located next to a mobile phone, laptop, or other electronic device, the wireless signal may get blocked, and the driver's door may not unlock automatically.

If a door is open with the ignition either placed in the ACC or ON/RUN (engine not running) position, a chime will sound as a reminder.

**KEYLESS ENTER 'n Go™ — PASSIVE ENTRY**

The Passive Entry system is an enhancement to the vehicle's key fob and a feature of Keyless Enter 'n Go™. This feature allows you to lock and unlock the vehicle's door(s) without having to push the key fob lock or unlock buttons.

**NOTE:**

- Passive Entry may be programmed on/off through Uconnect Settings → page 120.
- The key fob may not be detected by the vehicle Passive Entry system if it is located next to a mobile phone, laptop or other electronic device; these devices may block the key fob's wireless signal and prevent the Passive Entry handle from locking/unlocking the vehicle.
- Passive Entry unlock initiates illuminated approach (low beams, license plate lamp, position lamps) for whichever timing is set between 0, 30, 60 or 90 seconds. Passive Entry unlock also initiates two flashes of the turn signal lights.

- If wearing gloves, or if it has been raining/snowing on the Passive Entry door handle, the unlock sensitivity can be affected, resulting in a slower response time.
- If the vehicle is unlocked by Passive Entry and no door is opened within 60 seconds, the vehicle will relock and (if equipped) will arm the Vehicle Security system.

### To Unlock From The Driver Or Passenger Side

With a Passive Entry key fob within 5 ft (1.5 m) of the door handle, grab the handle to unlock the vehicle. Grabbing the driver's door handle will unlock the driver door automatically. Grabbing the passenger door handle will unlock both doors automatically. The interior door panel lock knob will raise when the door is unlocked.

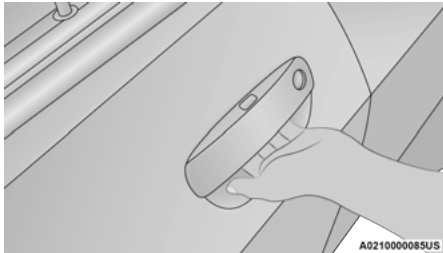

**Grab The Door Handle To Unlock**

### NOTE:

- Either the driver door only or all doors will unlock when you grab hold of the front driver's door handle, depending on the selected setting in the Uconnect system → page 120.
- All doors will unlock when the front passenger door handle is grabbed regardless of the driver's door unlock preference setting.

### Frequency Operated Button Integrated Key (FOBIK-Safe)

To minimize the possibility of unintentionally locking a Passive Entry key fob inside your vehicle, the Passive Entry system is equipped with an automatic door unlock feature which will function if the ignition is in the OFF position.

There are three situations that trigger a FOBIK-Safe search in any Passive Entry vehicle.

1. A lock request is made by a valid Passive Entry key fob while a door is open.
2. A lock request is made by the Passive Entry door handle while a door is open.
3. A lock request is made by the door panel switch while the door is open.

When any of these situations occur, after all open doors are shut, the FOBIK-Safe search will be executed. If it detects a Passive Entry key fob inside the car, and it does not detect any Passive Entry key fobs outside the car, the car will unlock and alert the customer.

### NOTE:

The vehicle will only unlock the doors when a valid Passive Entry key fob is detected inside the vehicle, and no valid Passive Entry key fob is detected outside the vehicle. The vehicle will not unlock the doors when any of the following conditions are true:

- The doors are manually locked using the door lock knobs.
- Three attempts are made to lock the doors using the door panel switch and then the doors are closed.
- There is a valid Passive Entry key fob outside the vehicle and within 5 ft (1.5 m) of either Passive Entry door handle.

**To Enter The Trunk:**

With a Passive Entry key fob within 5 ft (1.5 m) of the deck lid, push the button located on the center of the light bar which is located on the deck lid above the license plate.

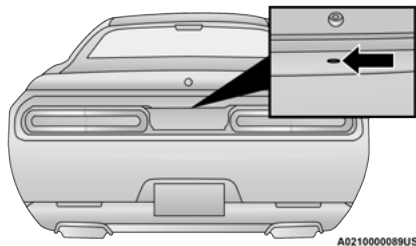

**Trunk Passive Entry Button**

**NOTE:**

If you inadvertently leave your vehicle's Passive Entry key fob in the trunk and try to close the deck lid, the deck lid will automatically unlatch, unless another one of the vehicle's Passive Entry key fobs is outside the vehicle and within 5 ft (1.5 m) of the deck lid.

**To Lock The Vehicle's Doors:**

With one of the vehicle's Passive Entry key fobs within 5 ft (1.5 m) of either door handle, pushing the Passive Entry lock button will lock both doors.

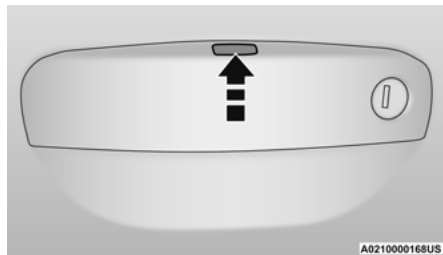

**Push The Door Handle Button To Lock**

Do NOT grab the door handle, when pushing the door handle button. This could unlock the door(s).



**Do NOT Grab The Handle When Locking**

**NOTE:**

- After pushing the door handle button, you must wait two seconds before you can lock or unlock the doors, using either Passive Entry door handle. This is done to allow you to check if the vehicle is locked by pulling the door handle, without the vehicle unlocking.
- The Passive Entry system will not operate if the key fob battery is depleted.

The vehicle doors can also be locked by using the key fob lock button or the lock button located on the vehicle's interior door panel ↪ page 318.

**AUTOMATIC UNLOCK DOORS ON EXIT**

The doors will unlock automatically on vehicles with power door locks if:

1. The Automatic Unlock Doors On Exit feature is enabled within Uconnect Settings ↪ page 120.
2. The transmission gear selector was not in PARK, then is placed in PARK.
3. The driver door is opened.
4. The doors were not previously unlocked.

**NOTE:**

Use the Automatic Unlock Doors On Exit feature in accordance with local laws.

## AUTOMATIC DOOR LOCKS — IF EQUIPPED

The auto door lock feature default condition is enabled. When enabled, the door locks will lock automatically when the vehicle's speed exceeds 15 mph (24 km/h). The auto door lock feature can be enabled or disabled by an authorized dealer per written request of the customer. Please see an authorized dealer for service.

## STEERING WHEEL

### MANUAL TILT/TELESCOPING STEERING COLUMN — IF EQUIPPED

This feature allows you to tilt the steering column upward or downward. It also allows you to lengthen or shorten the steering column. The tilt/telescoping lever is located below the steering wheel at the end of the steering column.

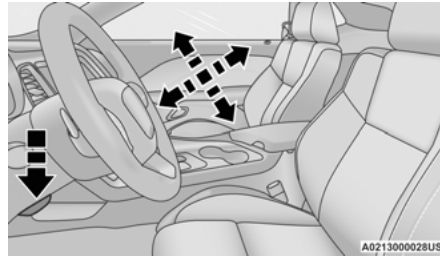

**Manual Tilt/Telescoping Control Handle**

To unlock the steering column, pull the lever downward (toward the floor). To tilt the steering column, move the steering wheel upward or downward as desired. To lengthen or shorten the steering column, pull the steering wheel outward or push it inward as desired. To lock the steering column in position, push the lever upward until fully engaged.

#### WARNING!

Do not adjust the steering column while driving. Adjusting the steering column while driving or driving with the steering column unlocked, could cause the driver to lose control of the vehicle. Failure to follow this warning may result in serious injury or death.

### POWER TILT/TELESCOPING STEERING COLUMN — IF EQUIPPED

This feature allows you to tilt the steering column upward or downward. It also allows you to lengthen or shorten the steering column. The power tilt/telescoping steering column control is located below the multifunction lever on the steering column.

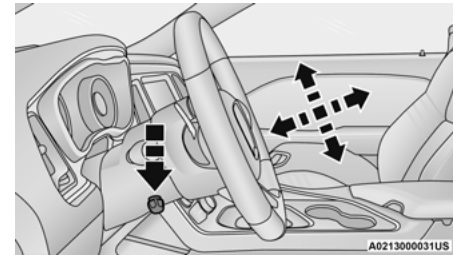

**Power Tilt/Telescoping Steering Column Control**

Use the four-way control to adjust the steering column.

**WARNING!**

Do not adjust the steering column while driving. Adjusting the steering column while driving or driving with the steering column unlocked, could cause the driver to lose control of the vehicle. Failure to follow this warning may result in serious injury or death.

## HEATED STEERING WHEEL — IF EQUIPPED



The steering wheel contains a heating element that helps warm your hands in cold weather. The heated steering wheel has only one temperature setting. Once the heated steering wheel has been turned on, it will stay on for an average of 80 minutes before automatically shutting off. This time will vary based on environmental temperatures. The heated steering wheel can shut off early or may not turn on when the steering wheel is already warm.

The heated steering wheel control button is located within the Uconnect system. You can gain access to the control button through the climate screen or the controls screen.

- Press the heated steering wheel button once to turn the heating element on.
- Press the heated steering wheel button a second time to turn the heating element off.

**NOTE:**

The engine must be running for the heated steering wheel to operate.

For information on use with the Remote Start system, see [page 19](#).

**WARNING!**

- Persons who are unable to feel pain to the skin because of advanced age, chronic illness, diabetes, spinal cord injury, medication, alcohol use, exhaustion, or other physical conditions must exercise care when using the steering wheel heater. It may cause burns even at low temperatures, especially if used for long periods.
- Do not place anything on the steering wheel that insulates against heat, such as a blanket or steering wheel covers of any type and material. This may cause the steering wheel heater to overheat.

## UCONNECT VOICE RECOGNITION

### INTRODUCING VOICE RECOGNITION

Start using Uconnect Voice Recognition with these helpful quick tips. It provides the key Voice Commands and tips you need to know to control your vehicle's Voice Recognition (VR) system.

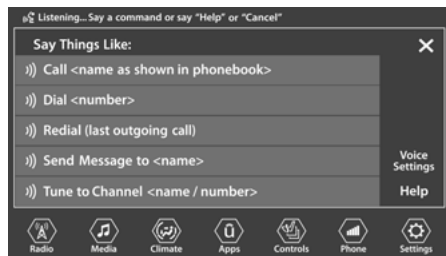

Uconnect 4 With 7-inch Display



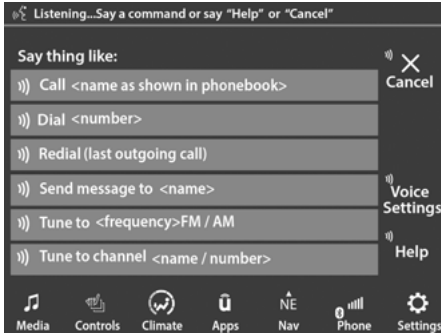

**Uconnect 4C/4C NAV With 8.4-inch Display**

If you see the NAV icon on the bottom bar or in the Apps menus of your 8.4-inch touchscreen, you have the Uconnect 4C NAV system. If not, you have a Uconnect 4C with 8.4-inch display system.

## BASIC VOICE COMMANDS

The following basic Voice Commands can be given at any point while using your Uconnect system.

Push the VR button . After the beep, say:

- **“Cancel”** to stop a current voice session
- **“Help”** to hear a list of suggested Voice Commands
- **“Repeat”** to listen to the system prompts again

Notice the visual cues that inform you of your VR system’s status. Cues appear on the touchscreen.

## GET STARTED

The Voice Recognition (VR) button  is used to activate/deactivate your Voice Recognition system.

Helpful hints for using Voice Recognition:

- Reduce background noise. Wind and passenger conversations are examples of noise that may impact recognition.
- Speak clearly at a normal pace and volume while facing straight ahead.
- Each time you give a Voice Command, you must first push the Voice Recognition (VR) button, wait until after the beep, then say your Voice Command.

- You can interrupt the help message or system prompts by pushing the VR button and saying a Voice Command from the current category.

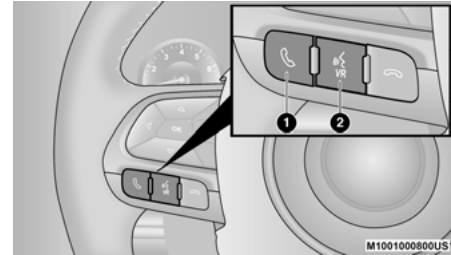

**Uconnect Voice Command Buttons**

- 1 — Push To Start Or Answer A Phone Call And Send Or Receive A Text
- 2 — Push The Voice Recognition Button To Begin Radio, Media, And Climate Functions

## ADDITIONAL INFORMATION

© 2022 FCA US LLC. All rights reserved. Mopar and Uconnect are registered trademarks and Mopar Owner Connect is a trademark of FCA US LLC. SiriusXM® and all related marks and logos are trademarks of SiriusXM® Radio Inc. ➔ page 318.

Uconnect System Support:

- US residents visit [www.DriveUconnect.com](http://www.DriveUconnect.com) or call: 1-877-855-8400 (24 hours a day 7 days a week)
- Canadian residents visit [www.DriveUconnect.ca](http://www.DriveUconnect.ca) or call: 1-800-465-2001 (English) or 1-800-387-9983 (French)

SiriusXM Guardian™ services support:

- US residents visit [www.driveuconnect.com/sirius-xm-guardian](http://www.driveuconnect.com/sirius-xm-guardian) or call: 1-844-796-4827
- Canadian residents visit <https://www.driveuconnect.ca/en/sirius-xm-guardian> or call: 1-877-324-9091

## DRIVER MEMORY SETTINGS — IF EQUIPPED

This feature allows the driver to save up to two different memory profiles for easy recall through a memory switch. Each memory profile saves desired position settings for the following features:

- Driver seat cushion
- Easy Entry/Exit seat (on/off) (if equipped)
- Side mirrors

- Power tilt/telescoping steering column (if equipped)

- A set of desired radio station presets

### NOTE:

- Your vehicle is equipped with two key fobs, each can be linked to either memory position 1 or 2.
- Be sure to program the radio presets prior to programming the memory settings.

The memory settings switch is located on the driver's door trim panel. The switch consists of three buttons:

- The set (S) button, which is used to activate the memory save function.
- The (1) and (2) buttons which are used to recall either of two saved memory profiles.

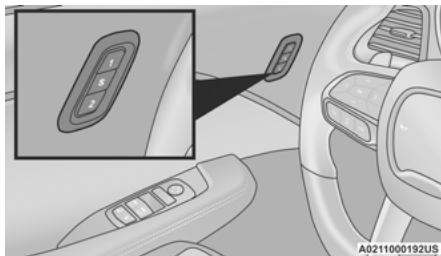

Memory Settings Switch

## PROGRAMMING THE MEMORY FEATURE

To create a new memory profile, perform the following:

### NOTE:

Saving a new memory profile will erase the selected profile from memory.

1. Place the vehicle's ignition in the ON/RUN position (do not start the engine).
2. Adjust all memory profile settings to desired preferences (i.e., seat, side mirror, power tilt and telescopic steering column [if equipped], and radio station presets).
3. Push and release the set (S) button on the memory switch, and then push the desired memory button (1 or 2) within five seconds. The instrument cluster display will display which memory position has been set.

### NOTE:

Memory profiles can be set without the vehicle in PARK, but the vehicle must be in PARK to recall a memory profile.

## LINKING AND UNLINKING THE KEY FOB TO MEMORY

Your key fobs can be programmed to recall one of two saved memory profiles.

### NOTE:

Before programming your key fobs you must select the “Personal Settings Linked To Key Fob” feature through the Uconnect system → page 120.

To program your key fobs, perform the following:

1. Place the vehicle’s ignition in the OFF position.
2. Select a desired memory profile, 1 or 2.
3. Once the profile has been recalled, push and release the set (S) button on the memory switch.
4. Within five seconds, push and release button (1) or (2) accordingly. “Memory Profile Set” (1 or 2) will display in the instrument cluster.
5. Push and release the lock button on the key fob within 10 seconds.

### NOTE:

Your key fob can be unlinked from your memory settings by pushing the set (S) button, followed by pushing the unlock button on the key fob within 10 seconds.

## MEMORY POSITION RECALL

### NOTE:

If a recall is attempted when the vehicle is not in PARK, a message will be displayed in the instrument cluster display.

To recall the memory settings for driver one or two, push the desired memory button number (1 or 2) or the unlock button on the key fob linked to the desired memory position.

A recall can be canceled by pushing any of the memory buttons (S, 1, or 2) during a recall. When a recall is canceled, the driver seat will stop moving. A delay of one second will occur before another recall can be selected.

### NOTE:

If the vehicle is equipped with Passive Entry, the memory settings are recalled when using Passive Entry to unlock the driver’s door with a linked key fob.

## SEATS

Seats are a part of the Occupant Restraint system of the vehicle.

### WARNING!

- It is dangerous to ride in a cargo area, inside or outside of a vehicle. In a collision, people riding in these areas are more likely to be seriously injured or killed.
- Do not allow people to ride in any area of your vehicle that is not equipped with seats and seat belts. In a collision, people riding in these areas are more likely to be seriously injured or killed.
- Be sure everyone in your vehicle is in a seat and using a seat belt properly.

## MANUAL ADJUSTMENT (FRONT SEATS) — IF EQUIPPED

### WARNING!

- Adjusting a seat while the vehicle is moving is dangerous. The sudden movement of the seat could cause you to lose control. The seat belt might not be adjusted properly and you could be injured. Adjust the seat only while the vehicle is parked.
- Do not ride with the seatback reclined so that the shoulder belt is no longer resting against your chest. In a collision you could slide under the seat belt and be seriously or even fatally injured. Use the recliner only when the vehicle is parked.

### Manual Front Seat Forward/Rearward Adjustment

The seat can be adjusted forward or rearward by using a bar located by the front of the seat cushion, near the floor.

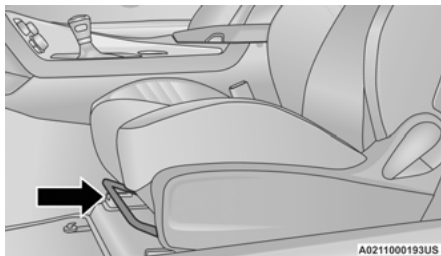

Adjusting Bar Location

While sitting in the seat, lift up on the bar located under the seat cushion and move the seat forward or rearward. Release the bar once you have reached the desired position. Then, using body pressure, move forward and rearward on the seat to be sure that the seat adjusters have latched.

### WARNING!

- Adjusting a seat while driving may be dangerous. Moving a seat while driving could result in loss of control which could cause a collision and serious injury or death.
- Seats should be adjusted before fastening the seat belts and while the vehicle is parked. Serious injury or death could result from a poorly adjusted seat belt.

### Manual Front Seat Recline

To adjust the seatback, lift the lever located on the outboard side of the seat, lean back to the desired position and release the lever. To return the seatback, lift the lever, lean forward and release the lever.

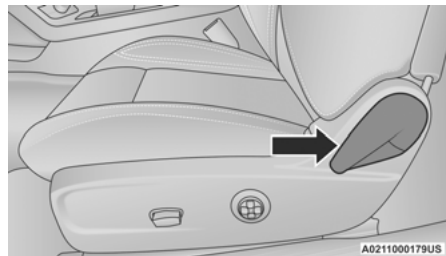

Recline Lever

### WARNING!

Do not ride with the seatback reclined so that the shoulder belt is no longer resting against your chest. In a collision you could slide under the seat belt, which could result in serious injury or death.

## MANUAL ADJUSTMENT (REAR SEATS)

### WARNING!

Do not pile luggage or cargo higher than the top of the seatback. This could impair visibility or become a dangerous projectile in a sudden stop or collision.

### Folding Rear Seat

The rear seatbacks can be folded forward to provide additional storage area. Pull on the loops located on the upper part of the rear seatback to fold down either or both seatbacks. These loops can be tucked away when not in use.

### NOTE:

You may experience deformation in the seat cushion from the seat belt buckles if the seats are left folded for an extended period of time. This is normal and, by simply unfolding the seats to the open position, over time the seat cushion will return to its normal shape.

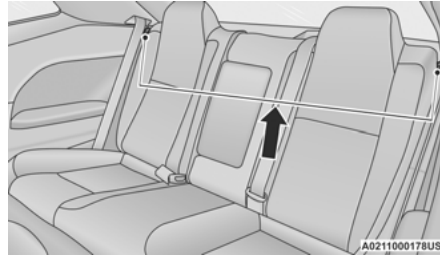

Folding Rear Seatback Loop Locations

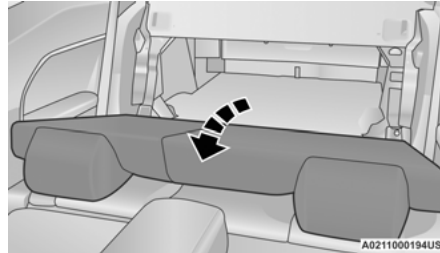

Folded Rear Seat

When the seatback is folded to the upright position, make sure it is latched by strongly pulling on the top of the seatback above the seat strap.

### WARNING!

- Be certain that the seatback is securely locked into position. If the seatback is not securely locked into position, the seat will not provide the proper stability for child seats and/or passengers. An improperly latched seat could cause serious injury.
- The cargo area in the rear of the vehicle (with the rear seatbacks in the locked-up or folded down position) should not be used as a play area by children when the vehicle is in motion. They could be seriously injured in a collision. Children should be seated and using the proper restraint system.

## POWER ADJUSTMENT (FRONT SEATS) — IF EQUIPPED

The power seat switches are located on the outboard side of the front seats. The power seat switches control the movement of the seat.

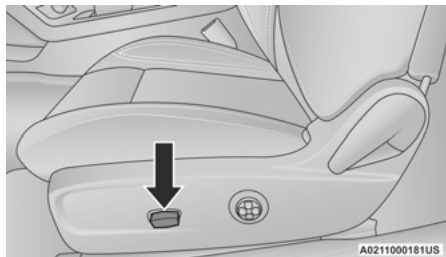

**Power Seat Switch**

### Adjusting The Seat Forward Or Rearward

The seat can be adjusted both forward and rearward by using the power seat switch. The seat will move in the direction of the switch. Release the switch when the desired position has been reached.

### Adjusting The Seat Up Or Down

The height of the seats can be adjusted up or down by using the power seat switch. The seat will move in the direction of the switch. Release the switch when the desired position has been reached.

### Tilting The Seat Up Or Down

The angle of the seat cushion can be adjusted up or down using the power seat switch. The front of the seat cushion will move in the direction of the switch. Release the switch when the desired position has been reached.

### Power Lumbar — If Equipped

Vehicles equipped with power driver or passenger seats may also be equipped with power lumbar. The power lumbar switch is located on the outboard side of the power seat. Push the switch forward or rearward to increase or decrease the lumbar support. Push the switch upward or downward to raise or lower the lumbar support.

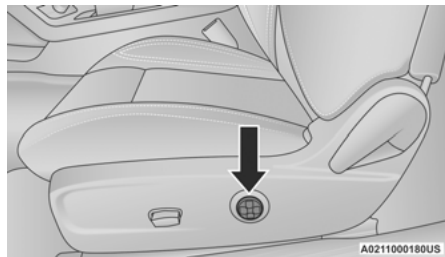

**Power Lumbar Switch**

### Easy Entry/Exit Seat — If Equipped

This feature provides automatic driver seat positioning to enhance driver mobility when entering and exiting the vehicle.

The distance the driver seat moves depends on where you have the driver seat positioned when you place the vehicle's ignition in the OFF position.

- When you place the vehicle's ignition in the OFF position, the driver seat will move about 2.4 inches (6.1 cm) rearward if the driver seat position is greater than or equal to 2.7 inches (6.8 cm) forward of the rear stop. The seat will return to its previously set position when you place the vehicle's ignition in the ACC or RUN position.
- The Easy Entry/Easy Exit feature is disabled when the driver seat position is less than 0.9 of an inch (2.3 cm) forward of the rear stop. At this position, there is no benefit to the driver by moving the seat for Easy Exit or Easy Entry.

When enabled in Uconnect Settings, Easy Entry and Easy Exit positions are stored in each memory setting profile ↗ page 28.

#### NOTE:

The Easy Entry/Exit feature is enabled or disabled through the programmable features in the Uconnect system ↗ page 120.

## HEATED SEATS — IF EQUIPPED

On some models, the front seats may be equipped with heaters located in the seat cushions and seatbacks.

### WARNING!

- Persons who are unable to feel pain to the skin because of advanced age, chronic illness, diabetes, spinal cord injury, medication, alcohol use, exhaustion or other physical condition must exercise care when using the seat heater. It may cause burns even at low temperatures, especially if used for long periods of time.
- Do not place anything on the seat or seatback that insulates against heat, such as a blanket or cushion. This may cause the seat heater to overheat. Sitting in a seat that has been overheated could cause serious burns due to the increased surface temperature of the seat.

## Front Heated Seats



The front heated seats control buttons are located within the Uconnect system. You can gain access to the control buttons through the climate screen and the controls screen.

You can choose from HI, LO, or OFF heat settings. The indicator arrows in touchscreen buttons indicate the level of heat in use. Two indicator arrows will illuminate for HI, and one for LO. Turning the heating elements off will return the user to the radio screen.

- Press the heated seat button once to turn the HI setting on.
- Press the heated seat button a second time to turn the LO setting on.
- Press the heated seat button a third time to turn the heating elements off.

### NOTE:

- Once a heat setting is selected, heat will be felt within two to five minutes.
- The engine must be running for the heated seats to operate.

- If the HI-level setting is selected, the system will automatically switch to LO-level after approximately 60 minutes of continuous operation. At that time, the display will change from HI to LO, indicating the change. The LO-level setting will turn off automatically after approximately 45 minutes.

For information on use with the Remote Start system, see [page 19](#).

### WARNING!

- Persons who are unable to feel pain to the skin because of advanced age, chronic illness, diabetes, spinal cord injury, medication, alcohol use, exhaustion or other physical condition must exercise care when using the seat heater. It may cause burns even at low temperatures, especially if used for long periods of time.
- Do not place anything on the seat or seatback that insulates against heat, such as a blanket or cushion. This may cause the seat heater to overheat. Sitting in a seat that has been overheated could cause serious burns due to the increased surface temperature of the seat.

## FRONT VENTILATED SEATS — IF EQUIPPED



The ventilated seats are equipped with fans that can be controlled through the climate and control screen in the Uconnect system. The fans operate at two speeds, HI and LO.

- Press the ventilated seat button once to choose HI.
- Press the ventilated seat button a second time to choose LO.
- Press the ventilated seat button a third time to turn the ventilated seat off.

### NOTE:

The engine must be running for the ventilated seats to operate.

For information on use with the Remote Start system, see ↗ page 19.

## VEHICLES WITHOUT PASSENGER SEATING INSTALLED

All passenger occupants within the vehicle must be in a seat equipped with a Seat Belt System and Head Restraint for the safety of the passenger. If the passenger and/or rear seats have been removed, do not ride in those areas.

This vehicle has been designed to maximize total performance. In doing so, the deletion of passenger seats and/or rear seat may affect the Noise, Vibration, and Harshness (NVH) characteristics. As a result, the interior will be louder overall.

### WARNING!

- If the passenger and/or rear seats have been removed, do not ride in those areas. In a collision, people riding in these areas are more likely to be seriously injured or killed.
- If this vehicle was not factory equipped with a passenger seat, NEVER attempt to install a passenger seat because the safety systems, including the air bags and seat belt, may not properly protect you.
- It is dangerous to ride in a cargo area, inside or outside of a vehicle. In a collision, people riding in this area are more likely to be seriously injured or killed.
- Only ride in available seating positions equipped with seat belt systems. Always properly wear your seat belt. Failure to do so could result in an increased risk of serious injury or death in the event of an accident.

*(Continued)*

### WARNING!

- Be sure everyone in your vehicle is in a seat and using a seat belt properly. Occupants, including the driver, should always wear their seat belts whether or not an air bag is also provided at their seating positions to minimize the risk of severe injury or death in the event of a crash.
- All occupants, including the driver, should not operate a vehicle or sit in a vehicle's seat if the head restraints are not in place of their proper positions in order to minimize the risk of neck injury in the event of a crash.
- Head restraints should never be adjusted while the vehicle is in motion. Driving a vehicle with the head restraints improperly adjusted or removed could cause serious injury or death in the event of a collision.

## PASSENGER SEAT EASY ENTRY

On the passenger seat, pull forward on the lever located on the side of the seatback in order to dump the seatback and slide the seat forward. You can also temporarily remove the seat belt from the guide loop on the seat and allow the seat belt to retract out of the way. This allows for easier access to the rear seat.



To return the seat to a normal seating position, first return the seatback to its original recline location and then slide the entire seatback to the preset lock position.



**Easy Entry Lever**

**NOTE:**

- The front passenger seat needs to slide back to a preset position for the for/aft adjuster to be properly locked. For example, if the front passenger has the seat adjusted full rear and exits the vehicle to let a rear passenger enter using the easy entry handle, the fore/aft adjuster needs to slide back about 2/3 of the way rearward to hit the lock position. If the adjuster is not returned to this preset position, the seat will appear to be loose.

- If the front passenger uses the easy entry handle and then lifts up the recliner handle without moving the seatback to its original preset position, the recliner will not lock until it is moved to the full recline position.

**Driver's Side Easy Entry**

The easy entry lever on the outboard side of the driver's seatback will dump the seatback forward to allow for easier access to the rear seats. The seat bottom will not slide forward as the passenger side easy entry will. If needed, use the driver's side seat control to slide forward.

To return the seat to the normal position, push the seatback up and it will lock into the previously set recline position. Then if needed, use the seat control to adjust the forward/rearward position.

**HEAD RESTRAINTS**

Head restraints are designed to reduce the risk of injury by restricting head movement in the event of a rear impact. Head restraints should be adjusted so that the top of the head restraint is located above the top of your ear.

**WARNING!**

- All occupants, including the driver, should not operate a vehicle or sit in a vehicle's seat until the head restraints are placed in their proper positions in order to minimize the risk of neck injury in the event of a crash.
- Head restraints should never be adjusted while the vehicle is in motion. Driving a vehicle with the head restraints improperly adjusted or removed could cause serious injury or death in the event of a collision.

**NOTE:**

Do not reverse the head restraints (making the rear of the head restraint face forward) in an attempt to gain additional clearance to the back of your head.

**Reactive Head Restraints – Front Seats**

The front driver and passenger seats are equipped with Reactive Head Restraints (RHR). In the event of a rear impact, the RHR will automatically extend forward minimizing the gap between the back of the occupants head and the RHR.

The RHR will automatically return to their normal position following a rear impact. If the RHR do not return to their normal position, see an authorized dealer immediately.

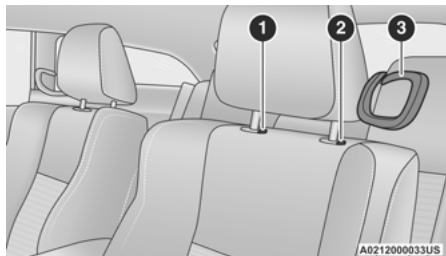
**Head Restraint**

- 1 – Release Button
- 2 – Adjustment Button
- 3 – Seat Belt Loop

To raise the head restraint, pull upward on the head restraint. To lower the head restraint, push the adjustment button located at the base of the head restraint and push downward on the head restraint.

To remove the head restraint, remove the seat belt from the seat belt loop. Raise the head restraint as far as it can go. Then, push the adjustment button and the release button at the base of each post while pulling the head restraint up. To reinstall the head restraint, put the head restraint posts into the holes while pushing the adjustment button and release button. Then, adjust it to the appropriate height.

**NOTE:**

It may be necessary to recline the front seat before removing the head restraint to provide enough clearance from the roof.

**WARNING!**

- A loose head restraint thrown forward in a collision or hard stop could cause serious injury or death to occupants of the vehicle. Always securely stow removed head restraints in a location outside the occupant compartment.
- ALL the head restraints MUST be reinstalled in the vehicle to properly protect the occupants. Follow the reinstallation instructions above prior to operating the vehicle or occupying a seat.
- Do not place items over the top of the Reactive Head Restraint, such as coats, seat covers or portable DVD players. These items may interfere with the operation of the Reactive Head Restraint in the event of a collision and could result in serious injury or death.

**Rear Head Restraints**

The rear outboard head restraints are non-adjustable and are designed to reduce the risk of injury by restricting head movement in the event of a rear impact.

**MIRRORS****INSIDE REARVIEW MIRROR****Automatic Dimming Mirror**

The rearview mirror can be adjusted up, down, left, and right. The mirror should be adjusted to center on the view through the rear window.

This mirror automatically adjusts for headlight glare from vehicles behind you.

**NOTE:**

The Automatic Dimming Mirror feature is disabled when the vehicle is in REVERSE to improve the driver's rear view.

The Automatic Dimming feature can be turned on or off through the touchscreen.



A0215000063JUS

**Automatic Dimming Mirror**

**CAUTION!**

To avoid damage to the mirror during cleaning, never spray any cleaning solution directly onto the mirror. Apply the solution onto a clean cloth and wipe the mirror clean.

**ILLUMINATED VANITY MIRRORS**

To access an illuminated vanity mirror, flip down one of the visors and lift the cover.

**Illuminated Vanity Mirror****Sun Visor Slide-On-Rod And Extender Feature**

The sun visor Slide-On-Rod feature allows for additional flexibility in positioning the sun visor to block out the sun.

1. Fold down the sun visor.
2. Unclip the visor from the corner clip.
3. Pivot the sun visor toward the side window.
4. Extend the sun visor for additional sun blockage.

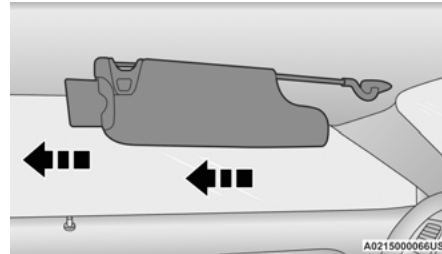
**Slide-On-Rod Extender**

To use the extender feature of the sun visor, grab the extender which is located at the rear of the visor and pull rearward.

**OUTSIDE MIRRORS**

The outside mirror(s) can be adjusted to the center of the adjacent lane of traffic to achieve the optimal view.

**NOTE:**

The passenger side convex outside mirror will give a much wider view to the rear, and especially of the lane next to your vehicle.

**WARNING!**

Vehicles and other objects seen in an outside convex mirror will look smaller and farther away than they really are. Relying too much on side convex mirrors could cause you to collide with another vehicle or other object. Use your inside mirror when judging the size or distance of a vehicle seen in a side convex mirror.

## POWER MIRRORS

The power mirror switch is located on the driver's side door trim panel.

The power mirror controls consist of mirror select buttons and a four-way mirror control switch. To adjust a mirror, push the mirror select button for the mirror that you want to adjust. Using the mirror control switch, push on any of the four arrows for the direction that you want the mirror to move.

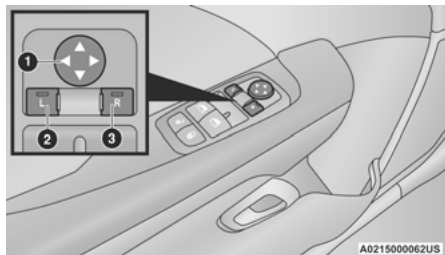

**Power Mirror Control**

- 1 — Mirror Adjustment
- 2 — Left Mirror Selection
- 3 — Right Mirror Selection

### NOTE:

A light in the select button will illuminate indicating the mirror is activated and can be adjusted.

## HEATED MIRRORS — IF EQUIPPED



These mirrors are heated to melt frost or ice. This feature will be activated whenever you turn on the rear window defroster (if equipped) → page 48.

## UNIVERSAL GARAGE DOOR OPENER (HOMELINK®)

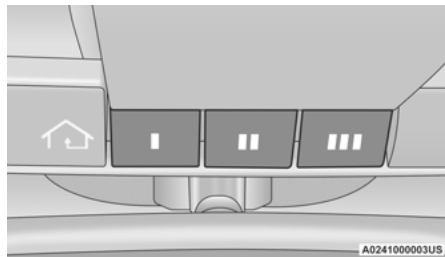

**HomeLink® Buttons And Indicator Light**

- HomeLink® replaces up to three hand-held transmitters that operate devices such as garage door openers, motorized gates, lighting or home security systems. The HomeLink® unit is powered by your vehicle's 12 Volt battery.

- The HomeLink® buttons that are located in the overhead console or sunvisor designate the three different HomeLink® channels.
- To operate HomeLink®, push and release any of the programmed HomeLink® buttons. These buttons will activate the devices they are programmed to with each press of the corresponding HomeLink® button.
- The HomeLink® indicator light is located above the center button → page 318.

## BEFORE YOU BEGIN PROGRAMMING HOMELINK®

For efficient programming and accurate transmission of the radio-frequency signal, it is recommended that a new battery be placed in the hand-held transmitter of the device that is being programmed to the HomeLink® system. Make sure your hand-held transmitter is programmed to activate the device you are trying to program your HomeLink® button to.

Ensure that your vehicle is parked outside of the garage before you begin programming.

It is recommended that you erase all the channels of your HomeLink® before you use it for the first time.

If you require assistance, please call toll-free 1-800-355-3515 or visit [HomeLink.com](http://HomeLink.com).

## ERASING ALL THE HOMELINK® CHANNELS

To erase the channels, follow this procedure:

1. Place the ignition switch into the ON/RUN position.
2. Push and hold the two outside HomeLink® buttons (I and III) for up to 20 seconds, or until the HomeLink® indicator light flashes.

### NOTE:

Erasing all channels should only be performed when programming HomeLink® for the first time. Do not erase channels when programming additional buttons.

## IDENTIFYING WHETHER YOU HAVE A ROLLING CODE OR NON-ROLLING CODE DEVICE

Before programming a device to one of your HomeLink® buttons, you must determine whether the device has a rolling code or non-rolling code.

### Rolling Code Devices

To determine if your device has a rolling code, a good indicator is its manufacturing date. Typically, devices manufactured after 1995 have rolling codes. A device with a rolling code will also have a “LEARN” or “TRAIN” button located where the

antenna is attached to the device. The button may not be immediately visible when looking at the device. The name and color of the button may vary slightly by manufacturer.

### NOTE:

The “LEARN” or “TRAIN” button is not the button you normally use to operate the device.

### Non-Rolling Code Devices

Most devices manufactured before 1995 will not have a rolling code. These devices will also not have a “LEARN” or “TRAIN” button.

## PROGRAMMING HOMELINK® TO A GARAGE DOOR OPENER

To program any of the HomeLink® buttons to activate your garage door opener motor, follow the steps below:

### NOTE:

All HomeLink® buttons are programmed using this procedure. You do not need to erase all channels when programming additional buttons.

1. Place the ignition switch into the ON/RUN position.
2. Place the garage door opener transmitter 1 to 3 inches (3 to 8 cm) away from the HomeLink® button you wish to program, while keeping the HomeLink® indicator light in view.

3. Push and hold the HomeLink® button you want to program while you push and hold the garage door opener transmitter button you are trying to replicate.
4. Continue to hold both buttons and observe the HomeLink® indicator light. The HomeLink® indicator light will flash slowly and then rapidly. Once this happens, release both buttons.

### NOTE:

Make sure the garage door opener motor is plugged in before moving on to the rolling code/ non-rolling code final steps.

### Rolling Code Garage Door Opener Final Steps

### NOTE:

You have 30 seconds to initiate rolling code final step 2, after completing rolling code final step 1.

1. At the garage door opener motor (in the garage), locate the “LEARN” or “TRAIN” button. This can usually be found where the hanging antenna wire is attached to the garage door opener motor. Firmly push and release the “LEARN” or “TRAIN” button.
2. Return to the vehicle and push the programmed HomeLink® button three times (holding the button for two seconds each time). If the garage door opener motor operates, programming is complete.

3. Push the programmed HomeLink® button to confirm that the garage door opener motor operates. If the garage door opener motor does not operate, repeat the final steps for the rolling code procedure.

#### Non-Rolling Code Garage Door Opener Final Steps

1. Push and hold the programmed HomeLink® button and observe the HomeLink® indicator light. If the HomeLink® indicator light stays on constantly, programming is complete.
2. Push the programmed HomeLink® button to confirm that the garage door opener motor operates. If the garage door opener motor does not operate, repeat the steps from the beginning.

#### WARNING!

- Your motorized door or gate will open and close while you are programming the universal transceiver. Do not program the transceiver if people or pets are in the path of the door or gate.

*(Continued)*

#### WARNING!

- Do not run your vehicle in a closed garage or confined area while programming the transceiver. Exhaust gas from your vehicle contains carbon monoxide (CO) which is odorless and colorless. Carbon monoxide is poisonous when inhaled and can cause you and others to be severely injured or killed.

### PROGRAMMING HOMELINK® TO A MISCELLANEOUS DEVICE

Follow the procedure on programming HomeLink® to a garage door opener ⇨ page 39. Be sure to determine if the device has a rolling code, or non-rolling code before beginning the programming process.

#### NOTE:

Canadian radio frequency laws require transmitter signals to time-out (or quit) after several seconds of transmission, which may not be long enough for HomeLink® to pick up the signal during programming. Similar to this Canadian law, some

U.S. gate operators are designed to time-out in the same manner. The procedure may need to be performed multiple times to successfully pair the device to your HomeLink® buttons.

### REPROGRAMMING A SINGLE HOMELINK® BUTTON

To reprogram a single HomeLink® button that has been previously trained, without erasing all the channels, follow the procedure below. Be sure to determine whether the new device you want to program the HomeLink® button to has a rolling code or non-rolling code.

1. Place the ignition in the ON/RUN position, without starting the engine.
2. Push and hold the desired HomeLink® button until the HomeLink® Indicator light begins to flash after 20 seconds. **Do not release the button.**
3. **Without releasing the button**, proceed with Step 2 in “Programming HomeLink® To A Garage Door Opener” and follow all remaining steps.

## CANADIAN/GATE OPERATOR PROGRAMMING

For programming transmitters in Canada/United States that require the transmitter signals to “time-out” after several seconds of transmission.

Canadian radio frequency laws require transmitter signals to time-out (or quit) after several seconds of transmission – which may not be long enough for HomeLink® to pick up the signal during programming. Similar to this Canadian law, some U.S. gate operators are designed to time-out in the same manner.

It may be helpful to unplug the device during the cycling process to prevent possible overheating of the garage door or gate motor.

1. Place the ignition in the ON/RUN position.
2. Place the hand-held transmitter 1 to 3 inches (3 to 8 cm) away from the HomeLink® button you wish to program while keeping the HomeLink® indicator light in view.
3. Continue to press and hold the HomeLink® button, while you press and release (cycle) your hand-held transmitter every two seconds until HomeLink® has successfully accepted the frequency signal. The indicator light will flash slowly and then rapidly when fully trained.

4. Watch for the HomeLink® indicator to change flash rates. When it changes, it is programmed. It may take up to 30 seconds or longer in rare cases. The garage door may open and close while you are programming.
5. Press and hold the programmed HomeLink® button and observe the indicator light.

### NOTE:

- If the indicator light stays on constantly, programming is complete and the garage door/device should activate when the HomeLink® button is pressed.
- To program the two remaining HomeLink® buttons, repeat each step for each remaining button. DO NOT erase the channels.

If you unplugged the garage door opener/device for programming, plug it back in at this time.

### Reprogramming A Single HomeLink® Button (Canadian/Gate Operator)

To reprogram a channel that has been previously trained, follow these steps:

1. Place the ignition in the ON/RUN position.
2. Press and hold the desired HomeLink® button until the indicator light begins to flash after 20 seconds. Do not release the button.

3. Without releasing the button, proceed with “Canadian/Gate Operator Programming” step 2 and follow all remaining steps.

## EXTERIOR LIGHTS

### HEADLIGHT SWITCH

The headlight switch is located on the left side of the instrument panel. This switch controls the operation of the headlights, parking lights, instrument panel lights, instrument panel light dimming, interior lights and fog lights (if equipped).

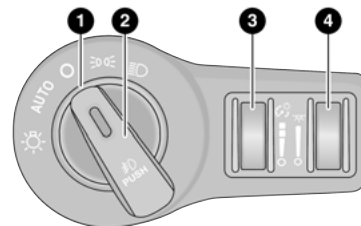

A0216000134US

#### Headlight Switch

- 1 — Rotate Headlight Control
- 2 — Push Fog Light Control
- 3 — Instrument Panel Dimmer Control
- 4 — Ambient Light Dimmer Control

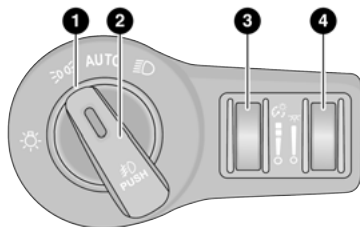

### Headlight Switch (Vehicles Sold In Canada Only)

- 1 — Rotate Headlight Control
- 2 — Push Fog Light Control
- 3 — Instrument Panel Dimmer Control
- 4 — Ambient Light Dimmer Control

#### NOTE:

Vehicles sold in Canada are equipped with a headlight switch with an AUTO and ON detent but without an OFF detent. Headlights will be deactivated when the headlight switch is placed in the parking lights position. However, the Daytime Running Lights (DRLs) will be activated along with the front and rear marker lights. The DRLs may be deactivated when the parking brake is engaged.

To turn on the headlights, rotate the headlight switch clockwise. When the headlight switch is on, the parking lights, taillights, license plate light and instrument panel lights are also turned on. To turn off the headlights, rotate the headlight switch back to the 0 (off) position.

#### NOTE:

For vehicles sold in Canada, rotate the headlight switch clockwise from the parking lights and instrument panel lights position to the first detent to turn the headlight switch to the AUTO position. Rotate to the second detent to turn on headlights, parking lights, and instrument panel lights operation.

### MULTIFUNCTION LEVER

The multifunction lever is located on the left side of the steering column.



### Multifunction Lever

### DAYTIME RUNNING LIGHTS (DRLs) — IF EQUIPPED

The Daytime Running Lights will turn on when the engine is started and will remain on unless the headlamps are turned to the on position, the parking brake is applied, or the ignition is placed in the OFF position.

#### NOTE:

- For vehicles sold in Canada, the Daytime Running Lights will automatically deactivate when the front fog lights are turned on.
- If allowed by law in the country in which the vehicle was purchased, the Daytime Running Lights can be turned on and off using the Uconnect system ↗ page 120.
- On some vehicles, the Daytime Running Lights may deactivate, or reduce intensity, on one side of the vehicle (when a turn signal is activated on that side), or on both sides of the vehicle (when the hazard warning lights are activated).

### HIGH/LOW BEAM SWITCH

Push the multifunction lever toward the instrument panel to switch the headlights to high beams. Pulling the multifunction lever back will turn the low beams on.



## AUTOMATIC HIGH BEAM HEADLAMP CONTROL — IF EQUIPPED

The Automatic High Beam Headlamp Control system provides increased forward lighting at night by automating high beam control through the use of a camera mounted on the windshield. This camera detects vehicle specific light and automatically switches from high beams to low beams until the approaching vehicle is out of view.

### NOTE:

- The Automatic High Beam Headlamp Control can be turned on or off using the Uconnect system ↪ page 120.
- Broken, muddy, or obstructed headlights and taillights of vehicles in the field of view will cause headlights to remain on longer (closer to the vehicle). Also, dirt, film, and other obstructions on the windshield or camera lens will cause the system to function improperly.
- To opt out of the Advanced Auto High-Beam Sensitivity Control and enter Reduced High-Beam Sensitivity Control (not recommended), toggle the high beam lever six full on/off cycles within 10 seconds of placing the ignition in the ON position. The system will return to the default setting upon placing the ignition in the OFF position.

- If the windshield or Automatic High Beam Headlamp Control mirror is replaced, the mirror must be re-aimed to ensure proper performance. See a local authorized dealer.

## FLASH-TO-PASS

You can signal another vehicle with your headlights by lightly pulling the multifunction lever toward you. This will cause the high beam headlights to turn on, and remain on, until the lever is released.

### NOTE:

If the multifunction lever is held in the flash-to pass position for more than 20 seconds, the high beams will shut off.

## AUTOMATIC HEADLIGHTS

This system automatically turns the headlights on or off according to ambient light levels. To turn the system on, rotate the headlight switch counterclockwise to the AUTO position. When the system is on, the headlight time delay feature is also on.

When the system is on, the Headlight Delay feature is also on. This means the headlights will stay on for up to 90 seconds after you place the ignition into the OFF position. To turn the automatic headlights off, turn the headlight switch out of the AUTO position.

### NOTE:

The engine must be running before the headlights will come on in the automatic mode.

## PARKING LIGHTS

To turn on the parking lights and instrument panel lights, rotate the headlight switch clockwise. To turn off the parking lights, rotate the headlight switch back to the O (off) position.

### NOTE:

Vehicles sold in Canada are equipped with a headlight switch with an AUTO and ON detent but without an OFF detent. Headlights will be deactivated when the headlight switch is placed in the parking lights position. However, the Daytime Running Lights (DRLs) will be activated along with the front and rear marker lights. The DRLs may be deactivated when the parking brake is engaged.

## AUTOMATIC HEADLIGHTS WITH WIPERS

If your vehicle is equipped with Automatic Headlights, it also has this customer-programmable feature. When your headlights are in the automatic mode and the engine is running, they will automatically turn on when the wiper system is on. This feature is programmable through the Uconnect system ↪ page 120.

In addition, the headlights will turn off when the wipers are turned off if they were turned on by this feature.

## HEADLIGHT TIME DELAY

To assist when exiting the vehicle, the headlight delay feature will leave the headlights on for up to 90 seconds. This delay is initiated when the ignition is placed in the OFF position while the headlight switch is on, and then the headlight switch is cycled off within 45 seconds. Headlight delay can be canceled by either turning the headlight switch on then off, or by placing the ignition in the ON position.

### NOTE:

- This feature can be programmed through the Uconnect system ↪ page 120.
- If you turn the headlights off before the ignition, they will turn off in the normal manner.

## LIGHTS-ON REMINDER

If the headlights or parking lights are on after the ignition is placed in the OFF position, the vehicle will chime when the driver's door is opened.

## FOG LIGHTS — IF EQUIPPED

To activate the front fog lights, turn on the parking lights or the low beam headlights, and push the fog light button on the headlight switch.

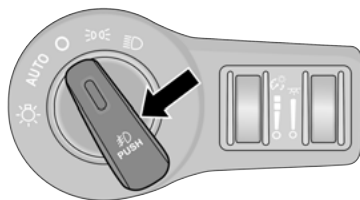

A0216000135US

Fog Light Switch

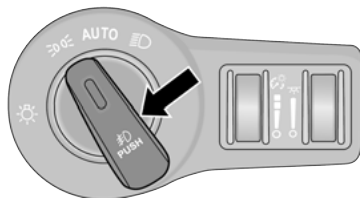

A0216000140US

Fog Light Switch (Vehicles Sold In Canada Only)

The fog lights will operate only when the parking lights are on or when the vehicle headlights are on low beam. An indicator light located in the instrument cluster will illuminate when the fog lights are on. The fog lights will turn off when the switch is pushed a second time, when the headlight switch is rotated to the off position, or the high beam is selected.

## TURN SIGNALS

Move the multifunction lever up or down to activate the turn signals. The arrows on each side of the instrument cluster flash to show proper operation.

### NOTE:

- If either light remains on and does not flash, or there is a very fast flash rate, check for a defective outside light bulb.
- A “Turn Signal On” message will appear in the instrument cluster display and a continuous chime will sound if the vehicle is driven more than 1 mile (1.6 km) with either turn signal on.

## LANE CHANGE ASSIST — IF EQUIPPED

Lightly push the multifunction lever up or down, without moving beyond the detent, and the turn signal will flash three times then automatically turn off.

## INTERIOR LIGHTS

The interior lights come on when a door is opened.

To protect the battery, the interior lights will turn off automatically 10 minutes after the ignition is placed in the OFF position. This will occur if the interior lights were switched on manually or are on because a door is open. The Battery Protection also includes the glove compartment light and the trunk light. To restore interior light operation after automatic battery protection is enabled (lights off), either place the ignition in the ON/RUN position or cycle the light switch.

### FRONT MAP/READING LIGHTS

These lights are mounted between the sun visors on the overhead console. Each light is turned on by pushing the lens. Push the lens a second time to turn off the light. These lights also turn on when a door is opened, when the unlock button on the remote keyless entry key fob is pushed, or when the dimmer control is turned fully upward, to the second detent.

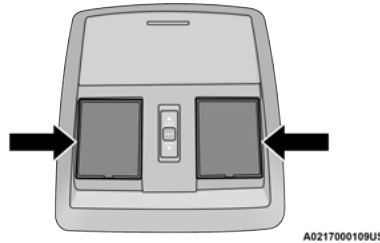

Map/Reading Lights

A0217000109US

### AMBIENT LIGHT — IF EQUIPPED

The overhead console is equipped with an ambient light feature. This light casts illumination for improved visibility of the floor and center console area.

Rotate the right dimmer control upward or downward to increase or decrease the brightness of the door handle lights, map pocket lights, and ambient light located in the overhead console.

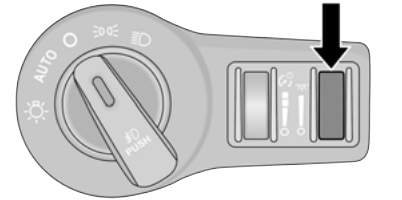

Door Handle/Ambient Light Dimmer

A0217000108US

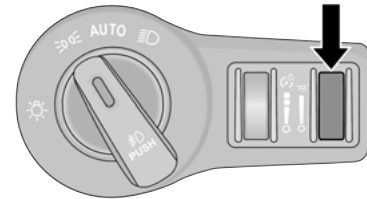

Door Handle/Ambient Light Dimmer  
(Vehicles Sold In Canada Only)

A0217000111US

## DIMMER CONTROL

The dimmer control is part of the headlight switch and is located on the left side of the instrument panel.

With the parking lights or headlights on, rotating the left dimmer control upward will increase the brightness of the instrument panel lights and lighted cupholders (if equipped).

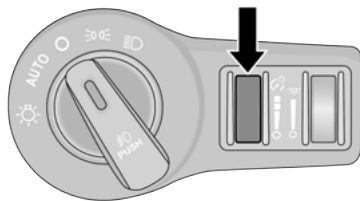

A0217000107US

**Instrument Panel Dimmer**

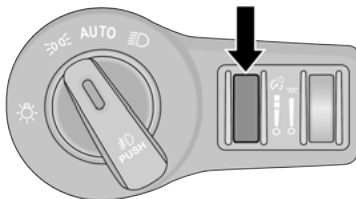

A0217000110US

### Instrument Panel Dimmer (Vehicles Sold In Canada Only)

Rotate the dimmer control completely upward to the second detent to turn on the interior lights. The interior lights will remain on when the dimmer control is in this position.

Rotate the instrument panel dimmer control to the O (off) position. The interior lights will remain off when the doors are open.

Rotate the instrument panel dimmer control upward to the first detent. This feature brightens all text displays such as the odometer, instrument cluster display, and radio when the parking lights or headlights are on.

## WINDSHIELD WIPERS AND WASHERS

The windshield wiper/washer controls are located on the multifunction lever on the left side of the steering column. The multifunction lever operates the windshield wipers and washer when the ignition is placed in the ACC or ON/RUN position.



A0216000133US

**Windshield Wiper/Washer Control**

## WINDSHIELD WIPER OPERATION

Rotate the end of the multifunction lever to the first detent, past the intermittent settings for low-speed wiper operation, or to the second detent past the intermittent settings for high-speed wiper operation.

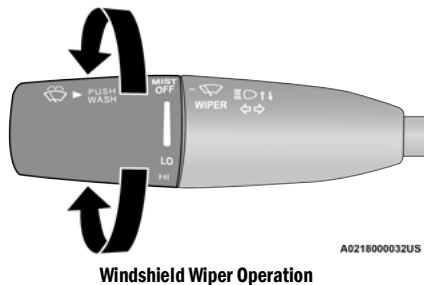

Windshield Wiper Operation

### Intermittent Wipers

Rotate the end of the multifunction lever to the first detent position, and then turn the end of the lever to select the desired delay interval. There are four delay settings, which allow you to regulate the wipe interval from a minimum of one cycle every second to a maximum of approximately 36 seconds between cycles. The delay intervals will double in duration when the vehicle speed is 10 mph (16 km/h) or less.

### Windshield Washers

To use the washer, push the multifunction lever inward (toward the steering wheel) and hold. If the lever is pushed while in the intermittent setting, the wipers will turn on and operate for two cycles after the end of the lever is released, and then resume the intermittent interval previously selected.

If the end of the lever is pushed while the wipers are in the off position, the wipers will operate for three wipe cycles and then turn off.

### WARNING!

Sudden loss of visibility through the windshield could lead to a collision. You might not see other vehicles or other obstacles. To avoid sudden icing of the windshield during freezing weather, warm the windshield with the defroster before and during windshield washer use.

### Mist

Rotate the end of the lever downward to the MIST position and release for a single wiping cycle. The wipers will continue to operate until you release the multifunction lever.

### NOTE:

The Mist feature does not activate the washer pump; therefore, no washer fluid will be sprayed on the windshield. The washer function must be used in order to spray the windshield with washer fluid.

For information on wiper care and replacement, see [page 265](#).

### CAUTION!

- Turn the windshield wipers off when driving through an automatic car wash. Damage to the windshield wipers may result if the wiper control is left in any position other than off.
- In cold weather, always turn off the wiper switch and allow the wipers to return to the park position before turning off the engine. If the wiper switch is left on and the wipers freeze to the windshield, damage to the wiper motor may occur when the vehicle is restarted.
- Always remove any buildup of snow that prevents the windshield wiper blades from returning to the off position. If the windshield wiper control is turned off and the blades cannot return to the off position, damage to the wiper motor may occur.

## RAIN SENSING WIPERS — IF EQUIPPED

This feature senses rain or snowfall on the windshield and automatically activates the wipers. Rotate the end of the multifunction lever to one of four settings to activate this feature.

The sensitivity of the system can be adjusted with the multifunction lever. Wiper delay position 1 is the least sensitive, and wiper delay position 4 is the most sensitive.

Wiper delay position three should be used for normal rain conditions.

### NOTE:

- The Rain Sensing feature will not operate when the wiper switch is in the low or high-speed position.
- The Rain Sensing feature may not function properly when ice, or dried salt water is present on the windshield.
- Use of products containing wax or silicone may reduce Rain Sensing performance.
- The Rain Sensing feature can be turned on and off using the Uconnect system ↗ page 120.

The Rain Sensing system has protection features for the wiper blades and arms, and will not operate under the following conditions:

- **Low Ambient Temperature** — When the ignition is first placed in the ON position, the Rain Sensing system will not operate until the wiper switch is moved, vehicle speed is greater than 0 mph (0 km/h), or the outside temperature is greater than 32 °F (0 °C).
- **Transmission In NEUTRAL Position** — When the ignition is ON, and the transmission is in the NEUTRAL position, the Rain Sensing system will not operate until the wiper switch is moved, vehicle speed is greater than 3 mph (5 km/h), or the gear selector is moved out of the NEUTRAL position.
- **Remote Start Mode Inhibit** — On vehicles equipped with Remote Start system, Rain Sensing wipers are not operational when the vehicle is in the Remote Start mode.

## CLIMATE CONTROLS

The Climate Control system allows you to regulate the temperature, air flow, and direction of air circulating throughout the vehicle. The controls are located on the touchscreen (if equipped) and on the instrument panel below the radio.

## AUTOMATIC CLIMATE CONTROL DESCRIPTIONS AND FUNCTIONS



**Uconnect 4 With 7-inch Display Automatic Climate Controls**



**Uconnect 4C/4C NAV With 8.4-inch Display Automatic Climate Controls**

## MAX A/C Button



Press and release the MAX A/C button on the touchscreen to change the current setting to the coldest output of air. The MAX A/C indicator illuminates when MAX A/C is on. Pressing and releasing the button again will cause the MAX A/C operation to exit.

### NOTE:

The MAX A/C button is only available on the touchscreen.

## A/C Button



Press and release this button on the touchscreen, or push the button on the faceplate to change the current setting. The A/C indicator illuminates when A/C is ON.

The Air Conditioning (A/C) button allows the operator to manually activate or deactivate the air conditioning system. When the air conditioning system is turned on, cool dehumidified air will flow through the outlets into the cabin.

### NOTE:

- If fog or mist appears on the windshield or side glass, select Defrost mode, and increase blower speed if needed.
- If your air conditioning performance seems lower than expected, check the front of the A/C condenser (located in front of the radiator), for

an accumulation of dirt or insects. Clean with a gentle water spray from the front of the radiator and through the condenser.

## Recirculation Button



Press and release this button on the touchscreen, or push the button on the faceplate to change the system between recirculation mode and outside air mode.

The Recirculation indicator and the A/C indicator illuminate when the Recirculation button is pressed. Recirculation can be used when outside conditions such as smoke, odors, dust, or high humidity are present. Recirculation can be used in all modes. Recirculation may be unavailable (button on the touchscreen greyed out) if conditions exist that could create fogging on the inside of the windshield. The A/C can be deselected manually without disturbing the mode control selection. Continuous use of the Recirculation mode may make the inside air stuffy and window fogging may occur. Extended use of this mode is not recommended.

In cold weather, use of Recirculation mode may lead to excessive window fogging. The Recirculation feature may be unavailable if conditions exist that could create fogging on the inside of the windshield.

## AUTO Button



Set your desired temperature and press AUTO. AUTO will achieve and maintain your desired temperature by automatically adjusting the blower speed and air distribution. AUTO mode is highly recommended for efficiency. You can press and release this button on the touchscreen, or push the button on the faceplate, to turn AUTO on. The AUTO indicator illuminates when AUTO is on. Toggling this function will cause the system to switch between manual mode and automatic modes [page 51](#).

## Front Defrost Button



Press and release the Front Defrost button on the touchscreen, or push and release the button on the faceplate, to change the current airflow setting to Defrost mode. The Front Defrost indicator illuminates when Front Defrost is on. Air comes from the windshield and side window demist outlets. When the defrost button is selected, the blower level may increase. Use Defrost mode with maximum temperature settings for best windshield and side window defrosting and defogging. When toggling the front defrost mode button, the climate system will return to the previous setting.

## Rear Defrost Button



Press and release the Rear Defrost button on the touchscreen, or push and release the button on the faceplate, to turn on the rear window defroster and the heated outside mirrors (if equipped). The Rear Defrost indicator illuminates when the rear window defroster is on. The rear window defroster automatically turns off after 10 minutes.

### CAUTION!

Failure to follow these cautions can cause damage to the heating elements:

- Use care when washing the inside of the rear window. Do not use abrasive window cleaners on the interior surface of the window. Use a soft cloth and a mild washing solution, wiping parallel to the heating elements. Labels can be peeled off after soaking with warm water.
- Do not use scrapers, sharp instruments, or abrasive window cleaners on the interior surface of the window.
- Keep all objects a safe distance from the window.

## Driver And Passenger Up And Down Buttons

These buttons provide the driver and passenger with independent temperature control.



Push the red button on the faceplate or touchscreen or press and slide the temperature bar towards the red arrow button on the touchscreen for warmer temperature settings.



Push the blue button on the faceplate or touchscreen or press and slide the temperature bar towards the blue arrow on the touchscreen for cooler temperature settings.

## SYNC Button



Press the SYNC button on the touchscreen to toggle the Sync feature on/off. The SYNC indicator is illuminated when SYNC is on. SYNC is used to synchronize the passenger temperature setting with the driver temperature setting. Changing the passenger temperature setting while in SYNC will automatically exit this feature.

### NOTE:

The SYNC button is only available on the touchscreen.

## Blower Control



Blower Control is used to regulate the amount of air forced through the Climate Control system. There are seven blower speeds available. Adjusting the blower will cause automatic mode to switch to manual operation. The speeds can be selected using either the blower control knob on the faceplate or the buttons on the touchscreen.

### Faceplate

The blower speed increases as you turn the blower control knob clockwise from the lowest blower setting. The blower speed decreases as you turn the blower control knob counterclockwise.

### Touchscreen

Use the small blower icon to reduce the blower setting and the large blower icon to increase the blower setting. Blower can also be selected by pressing the blower bar area between the icons.

## Mode Control



Select Mode by pressing one of the Mode buttons on the touchscreen to change the airflow distribution mode. The airflow distribution mode can be adjusted so air comes from the instrument panel outlets, floor outlets, defrost outlets and demist outlets.



## Panel Mode



Air comes from the outlets in the instrument panel. Each of these outlets can be individually adjusted to direct the flow of air. The air vanes of the center outlets and outboard outlets can be moved up and down or side to side to regulate airflow direction. There is a shut-off wheel located below the air vanes to shut off or adjust the amount of airflow from these outlets.

## Bi-Level Mode



Air comes from the instrument panel outlets and floor outlets. A slight amount of air is directed through the defrost and side window demister outlets.

### NOTE:

Bi-Level mode is designed under comfort conditions to provide cooler air out of the panel outlets and warmer air from the floor outlets.

## Floor Mode



Air comes from the floor outlets. A slight amount of air is directed through the defrost and side window demister outlets.

## Mix Mode



Air is directed through the floor, defrost, and side window demister outlets. This setting works best in cold or snowy conditions that require extra heat to the windshield. This setting is good for maintaining comfort while reducing moisture on the windshield.

## Climate Control OFF Button



Press and release this button to turn the Climate Control ON/OFF.

## AUTOMATIC TEMPERATURE CONTROL (ATC)

### Automatic Operation

1. Push the AUTO button on the faceplate, or the AUTO button on the touchscreen on the Automatic Temperature Control (ATC) Panel.
2. Next, adjust the temperature that you would like the system to maintain by adjusting the driver and passenger temperature control buttons. Once the desired temperature is displayed, the system will achieve and automatically maintain that comfort level.

3. When the system is set up for your comfort level, it is not necessary to change the settings. You will experience the greatest efficiency by simply allowing the system to function automatically.

### NOTE:

- It is not necessary to move the temperature settings for cold or hot vehicles. The system automatically adjusts the temperature, mode, and blower speed to provide comfort as quickly as possible.
- The temperature can be displayed in US or Metric units within Uconnect Settings  
 ↪ page 120.

To provide you with maximum comfort in the Automatic mode during cold start-ups, the blower fan will remain on low until the engine warms up. The blower will increase in speed and transition into Auto mode.

### Manual Operation Override

This system offers a full complement of manual override features. The AUTO symbol in the front ATC display will be turned off when the system is being used in the manual mode.

## CLIMATE — VOICE RECOGNITION

Adjust vehicle temperatures hands-free and keep everyone comfortable while you keep moving ahead. (If vehicle is equipped with climate control.)

Push the VR button. After the beep, say one of the following commands:

- “Set driver temperature to 70 degrees”
- “Set passenger temperature to 70 degrees”

### TIP:

Voice Command for Climate may only be used to adjust the interior temperature of your vehicle. Voice Command will not work to adjust the heated seats or steering wheel if equipped.

## OPERATING TIPS

Refer to the chart at the end of this section for suggested control settings for various weather conditions.

### Summer Operation

The engine cooling system must be protected with a high-quality antifreeze coolant to provide proper corrosion protection and to protect against engine overheating. OAT coolant (conforming to MS.90032) is recommended.

### Winter Operation

To ensure the best possible heater and defroster performance, make sure the engine cooling system is functioning properly and the proper amount, type, and concentration of coolant is used. Use of the Air Recirculation mode during Winter months is not recommended, because it may cause window fogging.

### Vacation/Storage

For information on maintaining the Climate Control system when the vehicle is being stored for an extended period of time, see ⇨ page 303.

### Window Fogging

Vehicle windows tend to fog on the inside in mild, rainy, and/or humid weather. To clear the windows, select Defrost or Mix mode and increase the front blower speed. Do not use the Recirculation mode without A/C for long periods, as fogging may occur.





### Outside Air Intake



Make sure the air intake, located directly in front of the windshield, is free of obstructions, such as leaves. Leaves collected in the air intake may reduce airflow, and if they enter the air distribution box, they could plug the water drains. In Winter months, make sure the air intake is clear of ice, slush, and snow.

### Cabin Air Filter

The climate control system filters out dust and pollen from the air. Contact an authorized dealer to service your cabin air filter, and to have it replaced when needed.

### Operating Tips Chart

WEATHER	CONTROL SETTINGS
Hot Weather And Vehicle Interior Is Very Hot	Set the mode control to  (Panel Mode), <sup>MAX</sup> (MAX A/C) on, and blower on high. Roll down the windows for a minute to flush out the hot air. Adjust the controls as needed to achieve comfort.
Warm Weather	Turn <sup>A/C</sup> (A/C) on and set the mode control to  (Panel Mode).
Cool Sunny	Operate in  (Bi-Level Mode).
Cool & Humid Conditions	Set the mode control to  (Mix Mode) and turn on <sup>A/C</sup> (A/C) to keep windows clear.

WEATHER	CONTROL SETTINGS
Cold Weather	Set the mode control to  (Floor Mode). If windshield fogging starts to occur, move the control to  (Mix Mode).

## INTERIOR STORAGE AND EQUIPMENT

### STORAGE

#### Glove Compartment

The glove compartment is located on the passenger side of the instrument panel.

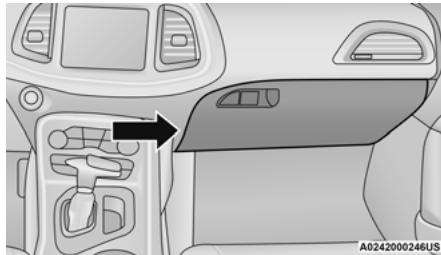

Glove Compartment

To open the glove compartment, pull the release handle.

#### Console Features

The center console has a storage compartment located underneath the armrest. The compartment contains a 12 Volt power outlet, and is also equipped with a USB port featuring active charging, which will continue charging your device up to 60 minutes after the ignition is turned off. The USB port also may be equipped with an IPOD®/USB control → page 54, or Apple CarPlay® and Android Auto™ → page 160.

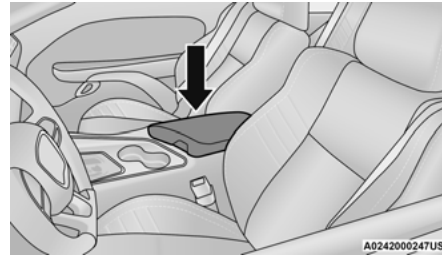

Center Console

WARNING!
Do not operate this vehicle with a console compartment lid in the open position. Driving with the console compartment lid open may result in injury in a collision.

2

### ILLUMINATED CUPHOLDERS — IF EQUIPPED

The front cupholders are equipped with a light ring that illuminates the cupholders for the front passengers. The light ring is controlled by the dimmer control → page 46.

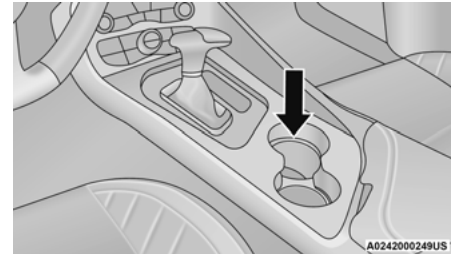

Light Ring In Front Cupholder

## USB/AUX CONTROL

Located in the front storage area of the center console, this feature allows an external USB device to be connected to the audio system.

Plugging in a smartphone device to a USB port may activate Android Auto™ or Apple CarPlay® features, if equipped

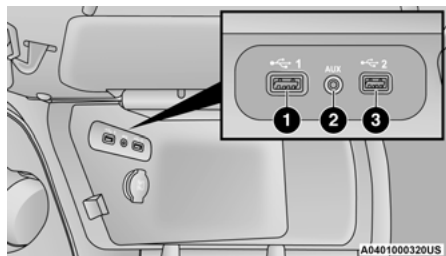

**USB/AUX Ports**

- 1 – USB 1 Port
- 2 – AUX Jack
- 3 – USB 2 Port

## POWER OUTLETS

Your vehicle is equipped with 12 Volt (13 Amp) power outlets that can be used to power cellular phones, small electronics and other low powered electrical accessories. The power outlets are labeled with either a “key” or a “battery” symbol to indicate how the outlet is powered. Power outlets labeled with a key symbol can be powered when the ignition is in the ACC or ON/RUN position, while the outlets labeled with a battery symbol are connected directly to the battery and powered at all times.

These power outlets can also operate a conventional cigar lighter unit.

The front power outlet is located next to the storage area on the integrated center stack of the instrument panel.

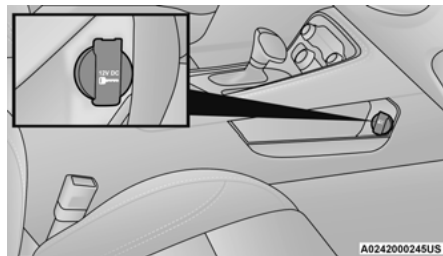

**Power Outlet – Integrated Center Stack Front**

## NOTE:

The front integrated center stack power outlet can be changed to battery powered at all times by moving the integrated center stack fuse #12 in the Rear Power Distribution Center from fuse location “IGN” to “B+” ↪ page 274.

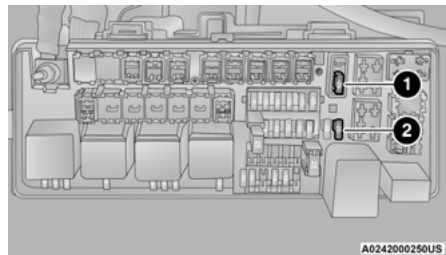

**Power Outlet Fuse Locations**

- 1 – #12 Fuse 20A Yellow Power Outlet Integrated Center Stack
- 2 – #38 Fuse 20A Yellow Power Outlet Center Console

In addition to the front center stack power outlet, there is also a power outlet located in the center console to the left of the media hub.

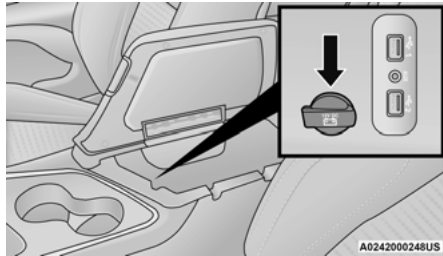

**Power Outlet – Center Console**

**NOTE:**

All accessories connected to these powered outlets should be removed or turned off when the vehicle is not in use to protect the battery against discharge.

**WARNING!**

To avoid serious injury or death:

- Only devices designed for use in this type of outlet should be inserted into any 12 Volt outlet.
- Do not touch with wet hands.

*(Continued)*

**WARNING!**

- Close the lid when not in use and while driving the vehicle.
- If this outlet is mishandled, it may cause an electric shock and failure.

**CAUTION!**

- Do not exceed the maximum power of 160 Watts (13 Amps) at 12 Volts. If the 160 Watt (13 Amp) power rating is exceeded the fuse protecting the system will need to be replaced.
- Power outlets are designed for accessory plugs only. Do not insert any other object in the power outlets as this will damage the outlet and blow the fuse. Improper use of the power outlet can cause damage not covered by your New Vehicle Limited Warranty.
- Many accessories that can be plugged in draw power from the vehicle's battery, even when not in use (i.e., cellular phones, etc.). Eventually, if plugged in long enough, the vehicle's battery will discharge sufficiently to degrade battery life and/or prevent the engine from starting.

*(Continued)*

**CAUTION!**

- Accessories that draw higher power (i.e., coolers, vacuum cleaners, lights, etc.), will degrade the battery even more quickly. Only use these intermittently and with greater caution.
- After the use of high power draw accessories, or long periods of the vehicle not being started (with accessories still plugged in), the vehicle must be driven a sufficient length of time to allow the alternator to recharge the vehicle's battery.
- Power outlets are designed for accessory plugs only. Do not hang any type of accessory or accessory bracket from the plug. Improper use of the power outlet can cause damage.

## WINDOWS

### POWER WINDOW CONTROLS

The window switches on the driver's door control all the door windows.

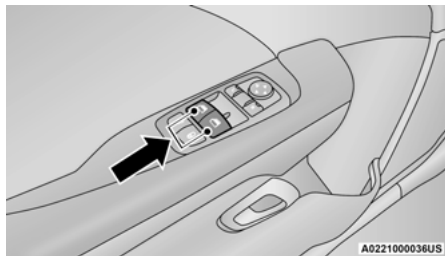

Power Window Switches

The passenger door window can also be operated by using the single window controls on the passenger door trim panel. The window controls will operate only when the ignition is in the ACC or ON/RUN position.

#### NOTE:

The power window switches will remain active for up to 10 minutes after the ignition is placed in the OFF position. Opening either front door will cancel this feature. The timing is programmable within Uconnect Settings → page 120.

#### WARNING!

Never leave children unattended in a vehicle, and do not let children play with power windows. Do not leave the key fob in or near the vehicle, or in a location accessible to children, and do not leave the ignition of a vehicle equipped with Keyless Enter 'n Go™ in the ACC or ON/RUN position. Occupants, particularly unattended children, can become entrapped by the windows while operating the power window switches. Such entrapment may result in serious injury or death.

### Automatic Window Features

The driver and, in some models, passenger power window switches have an Auto-Down feature. Push the window switch to the second detent, release, and the window will go down automatically.

To open the window part way, push the window switch to the first detent and release it when you want the window to stop.

To stop the window from going all the way down during the Auto-Down operation, pull up on the switch briefly.

## WIND BUFFETING

Wind buffeting can be described as the perception of pressure on the ears or a helicopter-type sound in the ears. Your vehicle may exhibit wind buffeting with the windows down, or the sunroof (if equipped) in certain open or partially open positions. This is a normal occurrence and can be minimized. If the buffeting occurs with the windows open, partially close the windows to minimize the buffeting. If the buffeting occurs with the sunroof open, adjust the sunroof opening to minimize the buffeting or open any window.

### POWER SUNROOF — IF EQUIPPED

The power sunroof switch is located between the sun visors on the overhead console.



A022500018US

Power Sunroof Switch

**WARNING!**

- Never leave children unattended in a vehicle, or with access to an unlocked vehicle. Never leave the key fob in or near the vehicle, or in a location accessible to children. Do not leave the ignition of a vehicle equipped with Keyless Enter 'n Go™ in the ACC or ON/RUN position. Occupants, particularly unattended children, can become entrapped by the power sunroof while operating the power sunroof switch. Such entrapment may result in serious injury or death.
- In a collision, there is a greater risk of being thrown from a vehicle with an open sunroof. You could also be seriously injured or killed. Always fasten your seat belt properly and make sure all passengers are also properly secured.
- Do not allow small children to operate the sunroof. Never allow your fingers, other body parts, or any object, to project through the sunroof opening. Injury may result.

**OPENING AND CLOSING THE SUNROOF****Express Open/Close**

Push the switch rearward and release it within one-half second, the sunroof and sunshade will open automatically and stop at full open position.

Push the switch forward and release it within one-half second and the sunroof will close automatically from any position.

During Express Open or Express Close operation, any other movement of the sunroof switch will stop the sunroof.

**Manual Open/Close**

Push and hold the switch rearward, the sunroof and sunshade will open and automatically stop at full open position.

Push and hold the switch forward and the sunroof will close from any position and stop at a full closed position.

Any release of the switch during open or close operation will stop the sunroof movement. The sunroof will remain in a partially opened position until the switch is operated and held again.

**PINCH PROTECT FEATURE —  
IF EQUIPPED**

This feature will detect an obstruction in the closing of the sunroof during the Express Close operation. If an obstruction in the path of the sunroof is detected, the sunroof will automatically retract. Remove the obstruction if this occurs.

**NOTE:**

If three consecutive sunroof close attempts result in Pinch Protect reversals, Pinch Protect will disable and the sunroof must be closed in Manual Mode.

**VENTING SUNROOF**

Push and release the Vent switch within one half second and the sunroof will open to the vent position. During Express Vent operation, any other actuation of the sunroof switches will stop the sunroof operation.

**SUNSHADE OPERATION**

The sunshade can be opened manually. However, the sunshade will open automatically as the sunroof opens.

**NOTE:**

The sunshade cannot be closed if the sunroof is open.

## SUNROOF MAINTENANCE

Use only a non-abrasive cleaner and a soft cloth to clean the glass panel. Periodically check for and clear out any debris that may have collected in the tracks.

## IGNITION OFF OPERATION

### NOTE:

- The power sunroof switch can remain active in Accessory Delay for up to approximately 10 minutes after the vehicle's ignition is placed to the OFF position. Opening either front door will cancel this feature.
- This feature is programmable using the Uconnect system → page 120.

## HOOD

### OPENING THE HOOD

To open the hood, two latches must be released.

1. Pull the release lever located underneath the driver's side of the instrument panel.

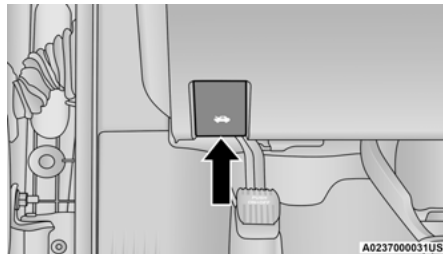

Hood Release Lever

2. Reach under the hood, push the safety catch to the left and lift the hood.

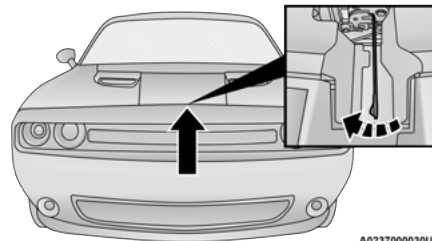

Hood Safety Catch Location



## CLOSING THE HOOD

### WARNING!

Be sure the hood is fully latched before driving your vehicle. If the hood is not fully latched, it could open when the vehicle is in motion and block your vision. Failure to follow this warning could result in serious injury or death.

### CAUTION!

To prevent possible damage, do not slam the hood to close it. Lower hood to approximately 12 inches (30 cm) and drop the hood to close. Make sure hood is fully closed for both latches. Never drive vehicle unless hood is fully closed, with both latches engaged.

## TRUNK

### OPENING THE TRUNK

The trunk may be opened in several ways:

- Power trunk release button on the instrument panel
- Trunk button on the key fob
- Trunk Passive Entry button ↗ page 22
- External release switch located on the underside of the decklid overhang

#### NOTE:

The release feature will function only when the vehicle is unlocked.

With the ignition in the ON/RUN position, the trunk open symbol will display in the instrument cluster indicating that the trunk is open. The odometer display will reappear once the trunk is closed.

With the ignition in the OFF position, the trunk open symbol will display until the trunk is closed.

### Power Trunk Release Button



The trunk can be opened from inside the vehicle using the power trunk release button located on the instrument panel to the left of the steering wheel.

#### NOTE:

The automatic transmission must be in PARK before the button will operate. For manual transmissions, the vehicle must be in NEUTRAL.

### Key Fob Trunk Release Button



Push the power trunk button on the key fob twice within five seconds to release the trunk.

### Passive Entry Button

Push the trunk Passive Entry button which is located on the back of the trunk lid. With a valid Passive Entry key fob within 5 ft (1.5 m) of the trunk, push the Passive Entry button to open the trunk.

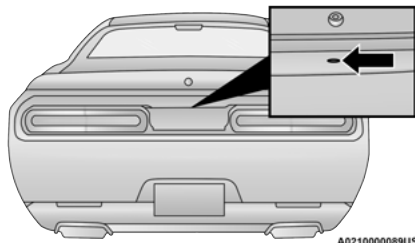

A0210000089US

**Trunk Passive Entry Button**

### CLOSING THE TRUNK

With one or more hands placed on the outside trunk surface push the trunk lid down until you hear the trunk lock latch into place.

#### NOTE:

Before closing the trunk lid, make sure your key fob is not inside the trunk area. The trunk will latch then automatically unlock if the key fob is detected, not allowing the key fob to be locked in the trunk area.

### TRUNK SAFETY

#### Trunk Emergency Release

As a security measure, a trunk internal emergency release lever is built into the trunk latching mechanism. In the event of an individual being locked inside the trunk, the trunk can be opened by actuating the glow-in-the-dark handle attached to the trunk latching mechanism.

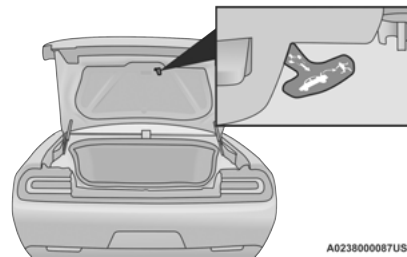

A0238000087US

**Trunk Emergency Release**

#### WARNING!

Do not allow children to have access to the trunk, either by climbing into the trunk from outside, or through the inside of the vehicle. Always close the trunk lid when your vehicle is unattended. Once in the trunk, young children may not be able to escape, even if they entered through the rear seat. If trapped in the trunk, children can die from suffocation or heat stroke.

# GETTING TO KNOW YOUR INSTRUMENT PANEL

## INSTRUMENT CLUSTER

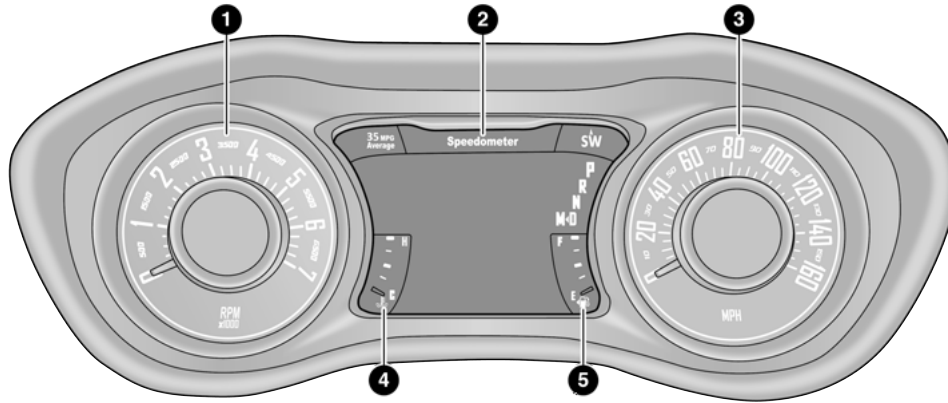

A0301000093US

Instrument Cluster For 3.6L or 5.7L Engine

## INSTRUMENT CLUSTER DESCRIPTIONS

1. Tachometer
  - Indicates the engine speed in revolutions per minute (RPM x 1000).
2. Instrument Cluster Display
  - When the appropriate conditions exist, this display shows the instrument cluster display messages → page 62.
3. Speedometer
  - Indicates vehicle speed.
4. Temperature Gauge
  - The temperature gauge shows engine coolant temperature. Any reading within the normal range indicates that the engine cooling system is operating satisfactorily.
  - The gauge pointer will likely indicate a higher temperature when driving in hot weather, up mountain grades, or when towing a trailer. It should not be allowed to exceed the upper limits of the normal operating range.

### WARNING!

A hot engine cooling system is dangerous. You or others could be badly burned by steam or boiling coolant. It is recommended to call an authorized dealer for service if your vehicle overheats → page 268.

### CAUTION!

Driving with a hot engine cooling system could damage your vehicle. If the temperature gauge reads “H,” pull over and stop the vehicle. Idle the vehicle with the air conditioner turned off until the pointer drops back into the normal range. If the pointer remains on the “H,” turn the engine off immediately and call an authorized dealer for service.

### 5. Fuel Gauge

- The pointer shows the level of fuel in the fuel tank when the Keyless Push Button Ignition is in the ON/RUN position.



- The fuel pump symbol points to the side of the vehicle where the fuel door is located.

### NOTE:

The hard telltales will illuminate for a bulb check when the ignition is first cycled.

## INSTRUMENT CLUSTER DISPLAY

Your vehicle is equipped with an instrument cluster display, which offers useful information to the driver. With the ignition in the OFF mode, opening/closing of a door will activate the display for viewing, and display the total miles, or kilometers, in the odometer. Your instrument cluster display is designed to display important information about your vehicle’s systems and features. Using a driver interactive display located on the instrument panel, your instrument cluster display can show you how systems are working and give you warnings when they are not. The steering wheel mounted controls allow you to scroll through the main menus and submenus. You can access the specific information you want and make selections and adjustments.

## LOCATION AND CONTROLS

The instrument cluster display features an interactive display which is located in the instrument cluster.

This system conveniently allows the driver to select a variety of useful information by pushing the arrow buttons located on the left side of the steering wheel. The instrument cluster display menu items consist of the following:

- Speedometer
- Vehicle Info
- Performance
- Driver Assist — If Equipped
- Fuel Economy
- Trip
- Audio
- Messages
- Screen Setup

The system allows the driver to select information by pushing the following buttons mounted on the steering wheel:

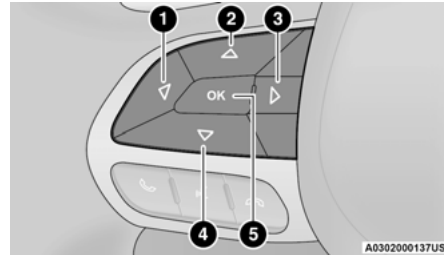

**Instrument Cluster Display Controls**

- 1 — Left Arrow Button
- 2 — Up Arrow Button
- 3 — Right Arrow Button
- 4 — Down Arrow Button
- 5 — OK Button

### Up And Down Arrow Buttons:

Using the **up** ▲ or **down** ▼ arrow button allows you to cycle through the Main Menu Items.

Changes the Main Screen area and Menu Title area.

### Left And Right Arrow Buttons:

Using the **left** ◀ or **right** ▶ arrow button allows you to cycle through the submenu items of the Main menu item.

### NOTE:

- Holding the **up** ▲ or **down** ▼ or **left** ◀ or **right** ▶ arrow button will loop the user through the currently selected menu or options presented on the screen.
- Upon returning to a main menu, the last submenu screen viewed within that main menu will be displayed.

### OK Button:

For Digital Speedometer:

- Pushing the **OK** button changes units (mph or km/h).

For Screen Setup:

- **OK** button allows user to enter menu and submenus.
- Within each submenu layer, the **up**  $\blacktriangle$  and **down**  $\blacktriangledown$  arrow buttons will allow the user to select the item of interest.
- Pushing the **OK** button makes the selection and a confirmation screen will appear (returning the user to the first page of the submenu).
- Pushing the **left**  $\blacktriangleleft$  arrow button will exit each submenu layer and return to the main menu.

For the Trip and Fuel Economy menus (and Performance Timers) — If Equipped:

- Information is reset by pushing and holding the **OK** button.

## ENGINE OIL LIFE RESET

### Oil Change Required

Your vehicle is equipped with an engine oil change indicator system. The “Oil Change Required” message will display in the instrument cluster display for five seconds after a single chime has sounded, to indicate the next scheduled oil change interval. The engine oil change indicator system is duty cycle based, which means the engine oil change interval may fluctuate, dependent upon your personal driving style.

Unless reset, this message will continue to display each time you place the ignition in the ON/RUN position. To turn off the message temporarily, push and release the **OK** or arrow buttons. To reset the oil change indicator system (after performing the scheduled maintenance), refer to the following procedure.

### Vehicles Equipped With Keyless Enter 'n Go™ — Ignition

Use the steering wheel instrument cluster display controls for the following procedure(s):

1. Without pressing the brake pedal, push the ENGINE START/STOP button and place the ignition in the ON/RUN position (do not start the engine).
2. Push and release the **down**  $\blacktriangledown$  arrow button to scroll downward through the main menu to “Vehicle Info.”
3. Push and release the **right**  $\blacktriangleright$  arrow button to access the “Oil Life” screen.
4. Push and hold the **OK** button to reset oil life. If conditions are met, the gauge and numeric display will update to show 100%. If conditions are not met a pop-up message of “To reset oil life engine must be off with ignition in run” will be displayed (for five seconds), and the user will remain at the Oil Life screen.

5. Push and release the **up**  $\blacktriangle$  or **down**  $\blacktriangledown$  arrow button to return to previous main menu.

### NOTE:

If the indicator message illuminates when you start the vehicle, the oil change indicator system did not reset. If necessary, repeat this procedure.

### Secondary Method Of Resetting Engine Oil Life

1. Without pressing the brake pedal, push the ENGINE START/STOP button and place the ignition to the ON/RUN position (do not start the engine).
2. Fully press the accelerator pedal, slowly, three times within ten seconds.
3. Without pushing the brake pedal, push the ENGINE START/STOP button once to return the ignition to the OFF position.

### NOTE:

If the indicator message illuminates when you start the vehicle, the oil change indicator system did not reset. If necessary, repeat this procedure.

## PERFORMANCE SHIFT INDICATOR (PSI)— IF EQUIPPED

The PSI is enabled on vehicles with manual transmission, or when a vehicle with automatic transmission is in manual shift mode. The PSI provides the driver with a visual indication within the instrument cluster display when the driver configured gear shift point has been reached and the driver is still accelerating. This indication notifies the driver to change gear corresponding to the configured RPMs in the head unit.

## INSTRUMENT CLUSTER DISPLAY SELECTABLE MENU ITEMS

Push and release the **up**  $\triangle$  or **down**  $\nabla$  arrow button until the desired Selectable Menu item is displayed in the instrument cluster display.

Follow the Menu or submenu prompts as desired.

### Speedometer

Push and release the **up**  $\triangle$  or **down**  $\nabla$  arrow button until the speedometer menu is displayed in the instrument cluster display. Push and release the **OK** button to toggle units (km/h or mph) of the speedometer.

### Vehicle Info

Push and release the **up**  $\triangle$  or **down**  $\nabla$  arrow button until the “Vehicle Info” menu is displayed in the instrument cluster display. Push and release the **right**  $\triangleright$  or **left**  $\triangleleft$  arrow button to scroll through the submenus items of “Vehicle Info.” Follow the directional prompts to access or reset any of the following “Vehicle Info” submenu items:

#### Tire Pressure Monitor

If tire pressure is **OK** for all tires, a vehicle **ICON** is displayed with tire pressure values in each corner of the **ICON**.

If one or more tires have low pressure, “Inflate Tire To XX” is displayed with the vehicle **ICON** and the tire pressure values in each corner of the **ICON** with the pressure value of the low tire are displayed in a different color than the other tire pressure value.

If the Tire Pressure system requires service, “Service Tire Pressure System” is displayed.

Tire PSI is an information only function and cannot be reset  $\rightarrow$  page 191.

#### Coolant Temp

- Displays the actual coolant temperature.

#### Trans Temp

- Displays the actual transmission temperature.

### Oil Temp

- Displays the actual oil temperature.

### Oil Pressure

- Displays the actual oil pressure.

### Oil Life

To reset the Oil Life, you must hold the **OK** button. The “Hold OK to Reset” instruction will be displayed at all times, but the following conditions will need to be met in order to reset Oil Life:

- The vehicle must be off
- The ignition must be in the ON/RUN position

If the conditions are met, holding the **OK** button will reset the gauge and the numeric display will return to 100%.

If the conditions are not met, a pop-up message will display for 5 seconds, describing the required conditions, and then the Oil Life screen will reappear.

### Battery Voltage

- Displays the actual battery voltage.

### All Wheel Drive (AWD) Status — If Equipped

- Displays the status of the All - Wheel Drive system.

## Performance Features

### WARNING!

Measurement of vehicle statistics with the Performance Features is intended for off-highway or track use only and should not be done on any public roadways. It is recommended that these features be used in a controlled environment and within the limits of the law. The capabilities of the vehicle as measured by the performance pages must never be exploited in a reckless or dangerous manner, which can jeopardize the user's safety or the safety of others. Only a safe, attentive, and skillful driver can prevent accidents.

Push and release the **up** ▲ or **down** ▼ arrow button until the Performance menu is displayed in the instrument cluster display. Push the **right** ► or **left** ◀ arrow button to enter the submenu.

The Performance Features include the following:

- 0-60 mph (0-100 km/h) Timer
  - Best
  - Last
  - Recent
  - Reaction Timer
- 0-100 mph (0-160 km/h) Timer
  - Best
  - Last
  - Recent
  - Reaction Timer
- 1/8 Mile (200 meters) Timer
  - Best
  - Last
  - Recent
  - Reaction Timer
- 1/4 Mile (400 meters) Timer
  - Best
  - Last
  - Recent
  - Reaction Timer
- Braking Distance
  - Distance
  - From Speed
- Current G-Forces
- Peak G-Forces
- Lap Timer
  - Lap History
    - Will list the last five laps with the best lap highlighted in green.
  - Top Speed

The following describes each feature and its operation:

### Driver Assist — If Equipped

#### Adaptive Cruise Control (ACC) Menu

The instrument cluster display displays the current ACC system settings. The information displayed depends on ACC system status.

Push the ACC ON/OFF button (located on the steering wheel) until one of the following displays in the instrument cluster display:

#### Adaptive Cruise Control Off

When ACC is deactivated, the display will read “Adaptive Cruise Control Off.”

#### Adaptive Cruise Control Ready

When ACC is activated but the vehicle speed setting has not been selected, the display will read “Adaptive Cruise Control Ready.”

Push the SET + or the SET- button (located on the steering wheel) and the following will display in the instrument cluster display:



## ACC SET

When ACC is set, the set speed will display in the instrument cluster.

If the Driver Assist main menu is not selected, an ACC pop - up message may display if any ACC activity occurs, which may include any of the following:

- Distance Setting Change
- System Cancel
- Driver Override
- System Off
- ACC Proximity Warning
- ACC Unavailable Warning

The instrument cluster display will return to the last display selected after five seconds of no ACC display activity ⇨ page 95.

## Fuel Economy

Two submenu pages; one with Current Value (instantaneous calculation of the fuel economy) displayed and one without the Current Value displayed (toggle the **left** ◀ or **right** ▶ arrow button to select one):

- Current Fuel Economy (MPG, L/100 km, or km/L).
- Range To Empty (miles or km).
- Average Fuel Economy (MPG, L/100 km, or km/L).

- The Max and Min values will correspond to the particular engine requirements.
- Lower end of gauge will be displayed in an amber color and turn green as Fuel Economy improves.
- Hold the **OK** button to reset average fuel economy information.

## Trip Info

Push and release the **up** ▲ or **down** ▼ arrow button until the Trip Menu item is displayed in the instrument cluster display. Toggle the **left** ◀ or **right** ▶ arrow button to select Trip A or Trip B. The Trip information will display the following:

- Distance – Shows the total distance (mi or km) traveled for Trip A or Trip B since the last reset.
- Average Fuel Economy – Shows the average fuel economy (MPG, L/100km or km/L) of Trip A or Trip B since the last reset.
- Elapsed Time – Shows the total elapsed time of travel since the last reset.

Hold the **OK** button to reset feature information.

## Audio

This menu displays the Audio information of the currently playing audio source (e.g. FM radio).

## Messages

This feature shows the number of stored warning messages, if any. Pushing the **right** ▶ or **left** ◀ arrow button will allow you to scroll through the stored messages.

## Screen Setup

Push and release the **up** ▲ or **down** ▼ arrow button until the Screen Setup Menu displays in the instrument cluster display. Push and release the **OK** button to enter the submenus. The Screen Setup feature allows you to change what information is displayed in the instrument cluster as well as the location that information is displayed.

1. Upper Left
  - Compass
  - Outside Temp
  - Time
  - Range to Empty
  - Average (MPG, L/100 km, or km/L)
  - Current (MPG, L/100 km, or km/L)
  - Trip A Distance
  - Trip B Distance
  - None

2. Upper Right
  - Compass
  - Outside Temp
  - Time
  - Range to Empty
  - Average (MPG, L/100 km, or km/L)
  - Current (MPG, L/100 km, or km/L)
  - Trip A Distance
  - Trip B Distance
  - None
3. Center
  - Menu Title
  - Compass
  - Outside Temp
  - Time
  - Range to Empty
  - Average (MPG, L/100 km, or km/L)
  - Current (MPG, L/100 km, or km/L)
  - Trip A Distance
  - Trip B Distance
  - Audio Information
  - Digital Speed
  - None

4. Current Gear
  - On
  - Off
5. Odometer
  - Show
  - Hide
6. Gear Display
  - Full
  - Single
7. Restore Defaults
  - Ok
  - Cancel

### **BATTERY SAVER ON/BATTERY SAVER MODE MESSAGE — ELECTRICAL LOAD REDUCTION ACTIONS — IF EQUIPPED**

This vehicle is equipped with an Intelligent Battery Sensor (IBS) to perform additional monitoring of the electrical system and status of the vehicle battery.

In cases when the IBS detects charging system failure, or the vehicle battery conditions are deteriorating, electrical load reduction actions will take place to extend the driving time and distance of the vehicle. This is done by reducing power to or turning off non-essential electrical loads.

Load reduction is only active when the engine is running. It will display a message if there is a risk of battery depletion to the point where the vehicle may stall due to lack of electrical supply, or will not restart after the current drive cycle.

When load reduction is activated, the message “Battery Saver On” or “Battery Saver Mode” will appear in the instrument cluster.

These messages indicate the vehicle battery has a low state of charge and continues to lose electrical charge at a rate that the charging system cannot sustain.

#### **NOTE:**

- The charging system is independent from load reduction. The charging system performs a diagnostic on the charging system continuously.
- If the Battery Charge Warning Light is on it may indicate a problem with the charging system  
 ↪ page 70.

The electrical loads that may be switched off (if equipped), and vehicle functions which can be affected by load reduction:

- Heated Seat/Vented Seats/Heated Wheel
- Heated/Cooled Cup Holders — If Equipped
- Rear Defroster And Heated Mirrors
- HVAC System

- 115 Volts AC Power Inverter System
- Audio and Telematics System

Loss of the battery charge may indicate one or more of the following conditions:

- The charging system cannot deliver enough electrical power to the vehicle system because the electrical loads are larger than the capability of the charging system. The charging system is still functioning properly.
- Turning on all possible vehicle electrical loads (e.g. HVAC to max settings, exterior and interior lights, overloaded power outlets +12 Volts, 115 Volts AC, USB ports) during certain driving conditions (city driving, towing, frequent stopping).
- Installing options like additional lights, upfitter electrical accessories, audio systems, alarms and similar devices.
- Unusual driving cycles (short trips separated by long parking periods).
- The vehicle was parked for an extended period of time (weeks, months).
- The battery was recently replaced and was not charged completely.
- The battery was discharged by an electrical load left on when the vehicle was parked.

- The battery was used for an extended period with the engine not running to supply radio, lights, chargers, +12 Volts portable appliances like vacuum cleaners, game consoles and similar devices.

### What to do when an electrical load reduction action message is present (“Battery Saver On” or “Battery Saver Mode”)

During a trip:

- Reduce power to unnecessary loads if possible:
  - Turn off redundant lights (interior or exterior)
  - Check what may be plugged in to power outlets +12 Volts, 115 Volts AC, USB ports
  - Check HVAC settings (blower, temperature)
  - Check the audio settings (volume)

After a trip:

- Check if any aftermarket equipment was installed (additional lights, upfitter electrical accessories, audio systems, alarms) and review specifications if any (load and Ignition Off Draw currents).
- Evaluate the latest driving cycles (distance, driving time and parking time).
- The vehicle should have service performed if the message is still present during consecutive trips and the evaluation of the vehicle and driving pattern did not help to identify the cause.

## WARNING LIGHTS AND MESSAGES

The warning/indicator lights will illuminate in the instrument panel together with a dedicated message and/or acoustic signal when applicable. These indications are indicative and precautionary and as such must not be considered as exhaustive and/or alternative to the information contained in the Owner’s Manual, which you are advised to read carefully in all cases. Always refer to the information in this chapter in the event of a failure indication. All active telltales will display first if applicable. The system check menu may appear different based upon equipment options and current vehicle status. Some telltales are optional and may not appear.

### RED WARNING LIGHTS

#### Air Bag Warning Light



This warning light will illuminate to indicate a fault with the air bag, and will turn on for four to eight seconds as a bulb check when the ignition is placed in the ON/RUN or ACC/ON/RUN position. This light will illuminate with a single chime when a fault with the air bag has been detected, it will stay on until the fault is cleared. If the light is either not on during startup, stays on, or turns on while driving, have the system inspected at an authorized dealer as soon as possible.

## Brake Warning Light

**BRAKE** This warning light monitors various brake functions, including brake fluid level and parking brake application. If the brake light turns on it may indicate that the parking brake is applied, that the brake fluid level is low, or that there is a problem with the Anti-Lock Brake System reservoir.

If the light remains on when the parking brake has been disengaged, and the fluid level is at the full mark on the master cylinder reservoir, it indicates a possible brake hydraulic system malfunction or that a problem with the Brake Booster has been detected by the Anti-Lock Brake System (ABS) / Electronic Stability Control (ESC) system. In this case, the light will remain on until the condition has been corrected. If the problem is related to the brake booster, the ABS pump will run when applying the brake, and a brake pedal pulsation may be felt during each stop.

The dual brake system provides a reserve braking capacity in the event of a failure to a portion of the hydraulic system. A leak in either half of the dual brake system is indicated by the Brake Warning Light, which will turn on when the brake fluid level in the master cylinder has dropped below a specified level.

The light will remain on until the cause is corrected.

### NOTE:

The light may flash momentarily during sharp cornering maneuvers, which change fluid level conditions. The vehicle should have service performed, and the brake fluid level checked. If brake failure is indicated, immediate repair is necessary.

### WARNING!

Driving a vehicle with the red brake light on is dangerous. Part of the brake system may have failed. It will take longer to stop the vehicle. You could have a collision. Have the vehicle checked immediately.

Vehicles equipped with the Anti-Lock Brake System (ABS) are also equipped with Electronic Brake Force Distribution (EBD). In the event of an EBD failure, the Brake Warning Light will turn on along with the ABS Light. Immediate repair to the ABS system is required.

Operation of the Brake Warning Light can be checked by turning the ignition switch from the OFF position to the ON/RUN position. The light should illuminate for approximately two seconds. The light should then turn off unless the parking brake is applied or a brake fault is detected. If the light does not illuminate, have the light inspected by an authorized dealer.

The light also will turn on when the parking brake is applied with the ignition switch in the ON/RUN position.

### NOTE:

This light shows only that the parking brake is applied. It does not show the degree of brake application.

## Seat Belt Reminder Warning Light



This warning light indicates when the driver or passenger seat belt is unbuckled. When the ignition is first placed in the ON/RUN or ACC/ON/RUN position and if the driver's seat belt is unbuckled, a chime will sound and the light will turn on. When driving, if the driver or front passenger seat belt remains unbuckled, the Seat Belt Reminder Light will flash or remain on continuously and a chime will sound ↷ page 194.

## Battery Charge Warning Light



This warning light will illuminate when the battery is not charging properly. If it stays on while the engine is running, there may be a malfunction with the charging system. Contact an authorized dealer as soon as possible.

This indicates a possible problem with the electrical system or a related component.

### Door Open Warning Light



This indicator will illuminate when a door is ajar/open and not fully closed.

#### NOTE:

If the vehicle is moving, there will also be a single chime.

### Electric Power Steering (EPS) Fault Warning Light



This warning light will turn on when there's a fault with the EPS system  
 ⇨ page 92.

#### WARNING!

Continued operation with reduced assist could pose a safety risk to yourself and others. Service should be obtained as soon as possible.

### Electronic Throttle Control (ETC) Warning Light



This warning light will illuminate to indicate a problem with the ETC system. If a problem is detected while the vehicle is running, the light will either stay on or flash depending on the nature of the problem.

Cycle the ignition when the vehicle is safely and completely stopped and the transmission is placed

in the PARK position. The light should turn off. If the light remains on with the vehicle running, your vehicle will usually be drivable; however, see an authorized dealer for service as soon as possible.

#### NOTE:

This light may turn on if the accelerator and brake pedals are pressed at the same time.

If the light continues to flash when the vehicle is running, immediate service is required and you may experience reduced performance, an elevated/rough idle, or engine stall and your vehicle may require towing. The light will come on when the ignition is placed in the ON/RUN or ACC/ON/RUN position and remain on briefly as a bulb check. If the light does not come on during starting, have the system checked by an authorized dealer.

### Engine Coolant Temperature Warning Light



This warning light warns of an overheated engine condition. If the engine coolant temperature is too high, this indicator will illuminate and a single chime will sound. If the temperature reaches the upper limit, a continuous chime will sound for four minutes or until the engine is able to cool, whichever comes first.

If the light turns on while driving, safely pull over and stop the vehicle. If the Air Conditioning (A/C) system is on, turn it off. Also, shift the transmission into NEUTRAL and idle the vehicle. If the temperature reading does not return to normal, turn the engine off immediately and call for service  
 ⇨ page 245.

### Trunk Open Warning Light



This indicator will illuminate when the trunk is open and not fully closed.

#### NOTE:

If the vehicle is moving, there will also be a single chime.

### Oil Pressure Warning Light



This warning light will illuminate to indicate low engine oil pressure. If the light turns on while driving, stop the vehicle, shut off the engine as soon as possible, and contact an authorized dealer. A chime will sound when this light turns on.

Do not operate the vehicle until the cause is corrected. This light does not indicate how much oil is in the engine. The engine oil level must be checked under the hood.

### Oil Temperature Warning Light



This warning light will illuminate to indicate the engine oil temperature is high. If the light turns on while driving, stop the vehicle and shut off the engine as soon as possible. Wait for oil temperature to return to normal levels.

### Transmission Temperature Warning Light — If Equipped



This warning light will illuminate to warn of a high transmission fluid temperature. This may occur with strenuous usage such as trailer towing. If this light turns on, stop the vehicle and run the engine at idle or slightly faster, with the transmission in PARK (P) or NEUTRAL (N), until the light turns off. Once the light turns off, you may continue to drive normally.

#### WARNING!

If you continue operating the vehicle when the Transmission Temperature Warning Light is illuminated you could cause the fluid to boil over, come in contact with hot engine or exhaust components and cause a fire.

#### CAUTION!

Continuous driving with the Transmission Temperature Warning Light illuminated will eventually cause severe transmission damage or transmission failure.

### Vehicle Security Warning Light — If Equipped



This light will flash at a fast rate for approximately 15 seconds when the vehicle security system is arming, and then will flash slowly until the vehicle is disarmed.

### YELLOW WARNING LIGHTS

#### Service Adaptive Cruise Control Warning Light — If Equipped



This light will turn on when a ACC is not operating and needs service → page 95.

### Anti-Lock Brake System (ABS) Warning Light



This warning light monitors the ABS. The light will turn on when the ignition is placed in the ON/RUN or ACC/ON/RUN position and may stay on for as long as four seconds.

If the ABS light remains on or turns on while driving, then the Anti-Lock portion of the brake system is not functioning and service is required as soon as possible. However, the conventional brake system will continue to operate normally, assuming the Brake Warning Light is not also on.

If the ABS light does not turn on when the ignition is placed in the ON/RUN or ACC/ON/RUN position, have the brake system inspected by an authorized dealer.

#### Electronic Stability Control (ESC) Active Warning Light — If Equipped



This warning light will indicate when the ESC system is Active. The ESC Indicator Light in the instrument cluster will come on when the ignition is placed in the ON/RUN or ACC/ON/RUN position, and when ESC is activated. It should go out with the engine running. If the ESC Indicator Light comes on continuously with the engine running, a malfunction has been detected in the ESC system.

If this warning light remains on after several ignition cycles, and the vehicle has been driven several miles (kilometers) at speeds greater than 30 mph (48 km/h), see an authorized dealer as soon as possible to have the problem diagnosed and corrected.

- The ESC OFF Indicator Light and the ESC Indicator Light come on momentarily each time the ignition is placed in the ON/RUN or ACC/ON/RUN position.
- The ESC system will make buzzing or clicking sounds when it is active. This is normal; the sounds will stop when ESC becomes inactive.
- This light will come on when the vehicle is in an ESC event.

### Electronic Stability Control (ESC) OFF Warning Light — If Equipped



This warning light indicates the ESC is off.

Each time the ignition is turned to ON/RUN or ACC/ON/RUN, the ESC system will be on, even if it was turned off previously.

### Low Fuel Warning Light



When the fuel level reaches approximately 2 gal (7.5 L), this light will turn on and a chime will sound. The light will remain on until fuel is added.

### Low Washer Fluid Warning Light



This warning light will illuminate when the windshield washer fluid is low.

### Loose Fuel Filler Cap Warning Light — If Equipped



This warning light will illuminate when the fuel filler cap is loose. Properly close the filler cap to disengage the light. If the light does not turn off, please see an authorized dealer.

### Engine Check/Malfunction Indicator Warning Light (MIL)



The Engine Check/Malfunction Indicator Light (MIL) is a part of an Onboard Diagnostic System called OBD II that monitors engine and automatic

transmission control systems. This warning light will illuminate when the ignition is in the ON/RUN position before engine start. If the bulb does not come on when turning the ignition switch from OFF to ON/RUN, have the condition checked promptly.

Certain conditions, such as a loose or missing gas cap, poor quality fuel, etc., may illuminate the light after engine start. The vehicle should be serviced if the light stays on through several typical driving styles. In most situations, the vehicle will drive normally and will not require towing.

When the engine is running, the MIL may flash to alert serious conditions that could lead to immediate loss of power or severe catalytic converter damage. The vehicle should be serviced by an authorized dealer as soon as possible if this occurs.

#### WARNING!

A malfunctioning catalytic converter can reach higher temperatures than in normal operating conditions. This can cause a fire if you drive slowly or park over flammable substances such as dry plants, wood, cardboard, etc. This could result in death or serious injury to the driver, occupants or others.

#### CAUTION!

Prolonged driving with the Malfunction Indicator Light (MIL) on could cause damage to the vehicle control system. It also could affect fuel economy and driveability. If the MIL is flashing, severe catalytic converter damage and power loss will soon occur. Immediate service is required.

**Service AWD Warning Light — If Equipped**

This telltale will turn on to indicate the All Wheel Drive (AWD) system is not functioning properly and that service is required. Contact an authorized dealer.

**Service Forward Collision Warning (FCW) Light — If Equipped**

This warning light will illuminate to indicate a fault in the Forward Collision Warning System. Contact an authorized dealer for service → page 189.

**Tire Pressure Monitoring System (TPMS) Warning Light**

The warning light switches on and a message is displayed to indicate that the tire pressure is lower than the recommended value and/or that slow pressure loss is occurring. In these cases, optimal tire duration and fuel consumption may not be guaranteed.

Should one or more tires be in the condition mentioned previously, the display will show the indications corresponding to each tire.

**CAUTION!**

Do not continue driving with one or more flat tires as handling may be compromised. Stop the vehicle, avoiding sharp braking and steering. If a tire puncture occurs, repair immediately using the dedicated tire repair kit and contact an authorized dealer as soon as possible.

Each tire, including the spare (if provided), should be checked monthly when cold and inflated to the inflation pressure recommended by the vehicle manufacturer on the vehicle placard or tire inflation pressure label. If your vehicle has tires of a different size than the size indicated on the vehicle placard or tire inflation pressure label, you should determine the proper tire inflation pressure for those tires.

As an added safety feature, your vehicle has been equipped with a TPMS that illuminates a low tire pressure telltale when one or more of your tires is significantly underinflated. Accordingly, when the low tire pressure telltale illuminates, you should stop and check your tires as soon as possible, and inflate them to the proper pressure. Driving on a significantly underinflated tire causes the tire to overheat and can lead to tire failure. Underinflation also reduces fuel efficiency and tire tread life, and may affect the vehicle's handling and stopping ability.

Please note that the TPMS is not a substitute for proper tire maintenance, and it is the driver's responsibility to maintain correct tire pressure, even if underinflation has not reached the level to trigger illumination of the TPMS low tire pressure telltale.

Your vehicle has also been equipped with a TPMS malfunction indicator to indicate when the system is not operating properly. The TPMS malfunction indicator is combined with the low tire pressure telltale. When the system detects a malfunction, the telltale will flash for approximately one minute and then remain continuously illuminated. This sequence will continue upon subsequent vehicle start-ups as long as the malfunction exists. When the malfunction indicator is illuminated, the system may not be able to detect or signal low tire pressure as intended. TPMS malfunctions may occur for a variety of reasons, including the installation of replacement or alternate tires or wheels on the vehicle that prevent the TPMS from functioning properly. Always check the TPMS malfunction telltale after replacing one or more tires or wheels on your vehicle to ensure that the replacement or alternate tires and wheels allow the TPMS to continue to function properly.



**CAUTION!**

The TPMS has been optimized for the original equipment tires and wheels. TPMS pressures and warning have been established for the tire size equipped on your vehicle. Undesirable system operation or sensor damage may result when using replacement equipment that is not of the same size, type, and/or style. Aftermarket wheels can cause sensor damage. Using aftermarket tire sealants may cause the Tire Pressure Monitoring System (TPMS) sensor to become inoperable. After using an aftermarket tire sealant it is recommended that you take your vehicle to an authorized dealer to have your sensor function checked.

**YELLOW INDICATOR LIGHTS****Forward Collision Warning OFF Indicator Light — If Equipped**

This indicator light illuminates to indicate that Forward Collision Warning is off.

**GREEN INDICATOR LIGHTS****Adaptive Cruise Control (ACC) Set Without Target Vehicle Light — If Equipped**

This will display the distance setting for the ACC system when the system is engaged → page 95.

**Adaptive Cruise Control (ACC) Set With Target Vehicle Light — If Equipped**

This will display when the ACC is set and the vehicle in front is detected → page 95.

**Parking/Headlights On Indicator Light**

This indicator light will illuminate when the parking lights or headlights are turned on → page 41.

**Front Fog Indicator Light — If Equipped**

This indicator light will illuminate when the front fog lights are on → page 41.

**Turn Signal Indicator Lights**

When the left or right turn signal is activated, the turn signal indicator will flash independently and the corresponding exterior turn signal

lamps will flash. Turn signals can be activated when the multifunction lever is moved down (left) or up (right).

**NOTE:**

- A continuous chime will sound if the vehicle is driven more than 1 mile (1.6 km) with either turn signal on.
- Check for an inoperative outside light bulb if either indicator flashes at a rapid rate.

**ECO Mode Indicator Light — If Equipped**

This light will turn on when ECO Mode is active. Refer to the Drive Modes Supplement for further information.

**Cruise Control Set Indicator Light — If Equipped**

This indicator light will illuminate when the cruise control is set to the desired speed → page 93.

**Sport Mode Indicator Light — If Equipped**

This light will turn on when Sport Mode is active.

Refer to the Drive Modes Supplement for further information.

## WHITE INDICATOR LIGHTS

### Cruise Control Ready Indicator



This indicator light will illuminate when the cruise control is ready, but not set ↪ page 93.

### Adaptive Cruise Control (ACC) Ready Indicator Light — If Equipped



This light will turn on when ACC has been turned on, but is not set ↪ page 95.

### Speed Warning Indicator Light — If Equipped



The indicator light will illuminate white along with a notification text message (Speed Warning Set to XX followed by unit). When the set speed is just exceeded, a single chime will sound along with pop-up message of Speed Warning Exceeded. When the set speed is exceeded, the indicator will light up yellow and flash along with a continuous chime (up to 10 seconds or until the speed is no longer exceeded).

#### NOTE:

The number “31” is only an example of a speed that can be selected.

## BLUE INDICATOR LIGHTS

### High Beam Indicator Light



This indicator light will illuminate to indicate that the high beam headlights are on. With the low beams activated, push the multifunction lever forward (toward the front of the vehicle) to turn on the high beams. Pull the multifunction lever rearward (toward the rear of the vehicle) to turn off the high beams. If the high beams are off, pull the lever toward you for a temporary high beam on, “flash to pass” scenario.

## ONBOARD DIAGNOSTIC SYSTEM — OBD II

Your vehicle is equipped with a sophisticated Onboard Diagnostic system called OBD II. This system monitors the performance of the emissions, engine, and transmission control systems. When these systems are operating properly, your vehicle will provide excellent performance and fuel economy, as well as engine emissions well within current government regulations.

If any of these systems require service, the OBD II system will turn on the Malfunction Indicator Light (MIL). It will also store diagnostic codes and other information to assist your service technician in

making repairs. Although your vehicle will usually be drivable and not need towing, see an authorized dealer for service as soon as possible.

### CAUTION!

- Prolonged driving with the MIL on could cause further damage to the emission control system. It could also affect fuel economy and driveability. The vehicle must be serviced before any emissions tests can be performed.
- If the MIL is flashing while the vehicle is running, severe catalytic converter damage and power loss will soon occur. Immediate service is required.

## ONBOARD DIAGNOSTIC SYSTEM (OBD II) CYBERSECURITY

Your vehicle is required to have OBD II and a connection port to allow access to information related to the performance of your emissions controls. Authorized service technicians may need to access this information to assist with the diagnosis and service of your vehicle and emissions system ↪ page 119.

**WARNING!**

- ONLY an authorized service technician should connect equipment to the OBD II connection port in order to read the VIN, diagnose, or service your vehicle.
- If unauthorized equipment is connected to the OBD II connection port, such as a driver-behavior tracking device, it may:
  - Be possible that vehicle systems, including safety related systems, could be impaired or a loss of vehicle control could occur that may result in an accident involving serious injury or death.
  - Access, or allow others to access, information stored in your vehicle systems, including personal information.

## EMISSIONS INSPECTION AND MAINTENANCE PROGRAMS

In some localities, it may be a legal requirement to pass an inspection of your vehicle's emissions control system. Failure to pass could prevent vehicle registration.



For states that require an Inspection and Maintenance (I/M), this check verifies the Malfunction Indicator Light (MIL) is functioning and is not on when the engine is running, and that the OBD II system is ready for testing.

Normally, the OBD II system will be ready. The OBD II system may **not** be ready if your vehicle was recently serviced, recently had a dead battery or a battery replacement. If the OBD II system should be determined not ready for the I/M test, your vehicle may fail the test.

Your vehicle has a simple ignition actuated test, which you can use prior to going to the test station. To check if your vehicle's OBD II system is ready, you must do the following:

1. Cycle the ignition switch to the ON position, but do not crank or start the engine.

**NOTE:**

If you crank or start the engine, you will have to start this test over.

2. As soon as you cycle the ignition switch to the ON position, you will see the Malfunction Indicator Light (MIL) symbol come on as part of a normal bulb check.

3. Approximately 15 seconds later, one of two things will happen:
  - The MIL will flash for about 10 seconds and then return to being fully illuminated until you turn OFF the ignition or start the engine. This means that your vehicle's OBD II system is **not ready** and you should **not** proceed to the I/M station.
  - The MIL will not flash at all and will remain fully illuminated until you place the ignition in the off position or start the engine. This means that your vehicle's OBD II system is **ready** and you can proceed to the I/M station.

If your OBD II system is **not ready**, you should see an authorized dealer or repair facility. If your vehicle was recently serviced or had a battery failure or replacement, you may need to do nothing more than drive your vehicle as you normally would in order for your OBD II system to update. A recheck with the previously mentioned test routine may then indicate that the system is **now ready**.

Regardless of whether your vehicle's OBD II system is ready or not, if the MIL is illuminated during normal vehicle operation you should have your vehicle serviced before going to the I/M station. The I/M station can fail your vehicle because the MIL is on with the engine running.

# STARTING AND OPERATING

## STARTING THE ENGINE

Before starting your vehicle, adjust your seat, adjust the inside and outside mirrors, fasten your seat belt, and if present, instruct all other occupants to buckle their seat belts.

### WARNING!

- When exiting the vehicle, always make sure the ignition is in OFF mode, remove the key fob from the vehicle and lock the vehicle.
- Never leave children alone in a vehicle, or with access to an unlocked vehicle. Leaving children in a vehicle unattended is dangerous for a number of reasons. A child or others could be seriously or fatally injured. Children should be warned not to touch the parking brake, brake pedal or the transmission gear selector.
- Do not leave the key fob in or near the vehicle (or in a location accessible to children), and do not leave the ignition (of a vehicle equipped with Keyless Enter 'n Go™) in the ACC or ON/RUN mode. A child could operate power windows, other controls, or move the vehicle.

(Continued)

### WARNING!

- Do not leave children or animals inside parked vehicles in hot weather. Interior heat build-up may cause serious injury or death.

## MANUAL TRANSMISSION — IF EQUIPPED

Apply the parking brake, place the gear selector in NEUTRAL and press the clutch pedal before starting vehicle. This vehicle is equipped with a clutch interlocking ignition system. It will not start unless the clutch pedal is pressed to the floor.

## AUTOMATIC TRANSMISSION — IF EQUIPPED

The gear selector must be in the PARK position before you can start the engine. Apply the brakes before shifting into any driving gear.

### CAUTION!

- Shift into or out of PARK or REVERSE only after the vehicle has come to a complete stop.
- Do not shift between PARK, REVERSE, NEUTRAL, or DRIVE when the engine is above idle speed.
- Before shifting into any gear, make sure your foot is firmly pressing the brake pedal.

## Tip Start Feature — Automatic Transmission

Place the ignition in the START mode and release it as the starter engages. The starter motor will automatically disengage itself once engine is running. If the engine fails to start, the starter will disengage automatically in 10 seconds. If this occurs:

1. Place the ignition in the OFF mode.
2. Wait 10 to 15 seconds.
3. Repeat the “Normal Starting” procedure.

## NORMAL STARTING

### To Turn On The Engine Using The ENGINE START/STOP Button — Manual Transmission Only

1. Press and hold the clutch pedal while pushing and holding the ENGINE START/STOP button.
2. Release the ENGINE START/STOP button when the engine starts. If the vehicle fails to start within 15 seconds, release the ENGINE START/STOP button, wait 10 to 15 seconds, then repeat the “Normal Starting” procedure.
3. If you wish to stop the cranking of the engine prior to the engine starting, release the ENGINE START/STOP button.

#### NOTE:

Normal starting of either a cold or a warm engine is obtained without pumping or pressing the accelerator pedal.

### To Turn On The Engine Using The ENGINE START/STOP Button — Automatic Transmission Only

1. The transmission must be in PARK.
2. Press and hold the brake pedal while pushing the ENGINE START/STOP button once.

3. If the vehicle fails to start, the starter will disengage automatically after 10 seconds.
4. If you wish to stop the cranking of the engine prior to the engine starting, push the ENGINE START/STOP button again.

#### NOTE:

Normal starting of either a cold or a warm engine is obtained without pumping or pressing the accelerator pedal.

### To Turn Off The Engine Using ENGINE START/STOP Button — Manual Transmission Only

1. With the vehicle stopped, place the gear selector in NEUTRAL, then push and release the ENGINE START/STOP button.
2. The ignition will return to the OFF mode.
3. Place the gear selector in FIRST gear or REVERSE and then apply the parking brake.

#### NOTE:

- If the ignition switch is left in the ACC position, the system will automatically time out after 30 minutes of inactivity and the ignition will switch to the OFF position.
- If the ignition switch is left in the RUN position, the system will automatically time out after 30 minutes of inactivity if the vehicle speed is 0 mph (0 km/h) and the engine is not running.

- If the vehicle speed is above 5 mph (8 km/h), the ENGINE START/STOP button must be held for two seconds or three short pushes in a row before the engine will shut off. The ignition switch position will remain in the ACC position until the vehicle is stopped, placed in park and the button is pushed twice to the OFF position.

### To Turn Off The Engine Using ENGINE START/STOP Button — Automatic Transmission Only

1. Place the gear selector in PARK, then push and release the ENGINE START/STOP button.
2. The ignition will return to the OFF mode.
3. If the gear selector is not in PARK, the ENGINE START/STOP button must be held for two seconds or three short pushes in a row with the vehicle speed above 5 mph (8 km/h) before the engine will shut off. The ignition will remain in the ACC mode until the gear selector is in PARK and the button is pushed twice to the OFF mode. If the gear selector is not in PARK and the ENGINE START/STOP button is pushed once, the instrument cluster will display a “Vehicle Not In Park” message and the engine will remain running. Never leave a vehicle out of the PARK position, or it could roll.

**NOTE:**

If the ignition switch is left in the ACC or RUN (engine not running) position and the transmission is in PARK, the system will automatically time out after 30 minutes of inactivity and the ignition will switch to the OFF position.

**AUTOPARK**

AutoPark is a supplemental feature to assist in placing the vehicle in PARK should the situations on the following pages occur. It is a back up system and should not be relied upon as the primary method by which the driver shifts the vehicle into PARK.

The conditions under which AutoPark will engage are outlined on the following pages.

**WARNING!**

- Driver inattention could lead to failure to place the vehicle in PARK. ALWAYS DO A VISUAL CHECK that your vehicle is in PARK by verifying that a solid (not blinking) "P" is indicated in the instrument cluster display and on the gear selector. If the "P" indicator is blinking, your vehicle is not in PARK. As an added precaution, always apply the parking brake when exiting the vehicle.

(Continued)

**WARNING!**

- AutoPark is a supplemental feature. It is not designed to replace the need to shift your vehicle into PARK. It is a back up system and should not be relied upon as the primary method by which the driver shifts the vehicle into PARK.

**If the vehicle is not in PARK and the driver turns off the engine, the vehicle may AutoPark.**

AutoPark will engage when all of these conditions are met:

- Vehicle is equipped with an eight-speed transmission
- Vehicle is not in PARK
- Vehicle speed is 1.2 mph (1.9 km/h) or less
- Ignition switched from RUN to ACC

**NOTE:**

For Keyless Enter 'n Go™ equipped vehicles, the engine will turn off and the ignition switch will change to ACC mode. After 30 minutes, the ignition switches to OFF automatically, unless the driver turns the ignition switch OFF.

**If the vehicle is not in PARK and the driver exits the vehicle with the engine running, the vehicle may AutoPark.**

AutoPark will engage when all of these conditions are met:

- Vehicle is equipped with an eight-speed transmission
- Vehicle is not in PARK
- Vehicle speed is 1.2 mph (1.9 km/h) or less
- Driver's seat belt is unbuckled
- Driver's door is ajar
- Brake pedal is not pressed

The message "**AutoPark Engaged Shift to P then Shift to Gear**" will display in the instrument cluster.

**NOTE:**

In some cases the ParkSense graphic will be displayed in the instrument cluster. In these cases, the gear selector must be returned to "P" to select desired gear.

**If the driver shifts into PARK while moving, the vehicle may AutoPark.**

AutoPark will engage **ONLY** when vehicle speed is 1.2 mph (1.9 km/h) or less.

The message "**Vehicle Speed is Too High to Shift to P**" will be displayed in the instrument cluster if vehicle speed is above 1.2 mph (1.9 km/h).

**WARNING!**

If vehicle speed is above 1.2 mph (1.9 km/h), the transmission will default to NEUTRAL until the vehicle speed drops below 1.2 mph (1.9 km/h). A vehicle left in the NEUTRAL position can roll. As an added precaution, always apply the parking brake when exiting the vehicle.

**ALWAYS DO A VISUAL CHECK** that your vehicle is in PARK by looking for the "P" in the instrument cluster display and on the gear selector. As an added precaution, always apply the parking brake when exiting the vehicle.

## COLD WEATHER OPERATION (BELOW $-22^{\circ}\text{F}$ OR $-30^{\circ}\text{C}$ )

To ensure reliable starting at these temperatures, use of an externally powered electric engine block heater (available from an authorized dealer) is recommended.

## IF ENGINE FAILS TO START

If the engine fails to start after you have followed the "Normal Starting" or "Cold Weather Operation" procedure, it may be flooded. Push the accelerator pedal all the way to the floor and hold it there. Crank the engine for no more than 15 seconds.

This should clear any excess fuel in case the engine is flooded. Leave the ignition key in the RUN position, release the accelerator pedal and repeat the "Normal Starting" procedure.

**WARNING!**

- Never pour fuel or other flammable liquid into the throttle body air inlet opening in an attempt to start the vehicle. This could result in flash fire causing serious personal injury.
- Do not attempt to push or tow your vehicle to get it started. Vehicles equipped with an automatic transmission cannot be started this way. Unburned fuel could enter the catalytic converter and once the engine has started, ignite and damage the converter and vehicle.
- If the vehicle has a discharged battery, booster cables may be used to obtain a start from a booster battery or the battery in another vehicle. This type of start can be dangerous if done improperly → page 243.

**CAUTION!**

To prevent damage to the starter, do not continuously crank the engine for more than 25 seconds at a time. Wait 60 seconds before trying again.

## AFTER STARTING

The idle speed is controlled automatically, and it will decrease as the engine warms up.

## ENGINE BLOCK HEATER — IF EQUIPPED

The engine block heater warms the engine, and permits quicker starts in cold weather. Connect the cord to a standard 110-115 Volt AC electrical outlet with a grounded, three-wire extension cord.

The engine block heater must be plugged in at least one hour to have an adequate warming effect on the engine.

The engine block heater cord is routed under the hood on the driver side of the vehicle. It has a removable cap that is located near the air box.

**WARNING!**

Remember to disconnect the engine block heater cord before driving. Damage to the 110-115 Volt electrical cord could cause electrocution.

## ENGINE BREAK-IN RECOMMENDATIONS — 3.6L & 5.7L

A long break-in period is not required for the drivetrain (engine, transmission, clutch, and rear axle) in your new vehicle.

Drive moderately during the first 300 miles (500 km). After the initial 60 miles (100 km), speeds up to 50 or 55 mph (80 or 90 km/h) are desirable.

While cruising, brief full-throttle acceleration within the limits of local traffic laws contributes to a good break-in. However, wide-open throttle acceleration in low gear can be detrimental and should be avoided.

The engine oil, transmission fluid, and axle lubricant installed at the factory are high-quality and energy-conserving. Oil, fluid, and lubricant changes should be consistent with anticipated climate and conditions under which vehicle operations will occur. For the recommended viscosity and quality grades → page 312.

### CAUTION!

Never use Non-Detergent Oil or Straight Mineral Oil in the engine or damage may result.

### NOTE:

A new engine may consume some oil during its first few thousand miles (kilometers) of operation. This should be considered a normal part of the break-in and not interpreted as an indication of difficulty. Please check your oil level with the engine oil indicator often during the break in period. Add oil as required.

## PARKING BRAKE

Before leaving the vehicle, make sure that the parking brake is fully applied and place the gear selector in the PARK or REVERSE (manual transmission only) position.

When the parking brake is applied and the ignition switch is in the ON/RUN position, the Brake Warning Light in the instrument cluster will illuminate.

### NOTE:

- When the parking brake is applied and the transmission is placed in gear, the Brake Warning Light will flash. If vehicle speed is detected, a chime will sound to alert the driver. Fully release the parking brake before attempting to move the vehicle.
- This light only shows that the parking brake is applied. It does not show the degree of brake application.

When parking on a hill, it is important to turn the front wheels toward the curb on a downhill grade and away from the curb on an uphill grade. For vehicles equipped with an automatic transmission, apply the parking brake before placing the gear selector in PARK, otherwise the load on the transmission locking mechanism may make it difficult to move the gear selector out of PARK. The parking brake should always be applied whenever the driver is not in the vehicle.

### Manual Transmission — If Equipped

The foot operated parking brake is positioned below the lower left corner of the instrument panel. To release the parking brake, pull the parking brake release handle.

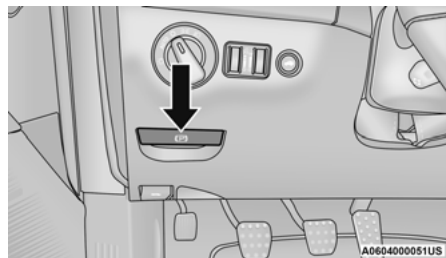

**Parking Brake Release**



### Automatic Transmission — If Equipped

The foot operated parking brake is located below the lower left corner of the instrument panel. To apply the parking brake, firmly push the parking brake pedal fully. To release the parking brake, press the parking brake pedal a second time and let your foot up as you feel the brake disengage.

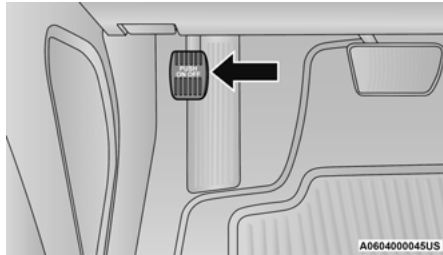

Parking Brake

#### WARNING!

- Never use the PARK position as a substitute for the parking brake. Always apply the parking brake fully when parked to guard against vehicle movement and possible injury or damage.
- When exiting the vehicle, always remove the key fob from the ignition and lock your vehicle.

(Continued)

#### WARNING!

- Never leave children alone in a vehicle, or with access to an unlocked vehicle. Allowing children to be in a vehicle unattended is dangerous for a number of reasons. A child or others could be seriously or fatally injured. Children should be warned not to touch the parking brake, brake pedal or the gear selector.
- When exiting the vehicle, always make sure the keyless ignition node is in the OFF mode, remove the key fob from the vehicle and lock the vehicle.
- Do not leave the key fob in or near the vehicle or in a location accessible to children, and do not leave the ignition of a vehicle equipped with Keyless Enter 'n Go™ in the ACC or ON/RUN mode. A child could operate power windows, other controls, or move the vehicle.
- Be sure the parking brake is fully disengaged before driving; failure to do so can lead to brake failure and a collision.
- Always fully apply the parking brake when leaving your vehicle, or it may roll and cause damage or injury. Also be certain to leave the transmission in PARK. Failure to do so may allow the vehicle to roll and cause damage or injury.

#### CAUTION!

If the Brake Warning Light remains on with the parking brake released, a brake system malfunction is indicated. Have the brake system serviced by an authorized dealer immediately.

## MANUAL TRANSMISSION — IF EQUIPPED

### SIX-SPEED MANUAL TRANSMISSION

4

#### WARNING!

You or others could be injured if you leave the vehicle unattended without having the parking brake fully applied. The parking brake should always be applied when the driver is not in the vehicle, especially on an incline.

#### CAUTION!

- Never drive with your foot resting on the clutch pedal, or try to hold the vehicle on a hill with the clutch pedal partially engaged, as this will cause abnormal wear on the clutch  
 ⇨ page 184.

(Continued)

**CAUTION!**

- Failure to press the clutch pedal fully to the floor may cause increased shift efforts, and may result in damage to the clutch and transmission.
- Do not rest your hand on the gear selector while driving, as this may result in transmission synchronizer damage.
- Do not attempt to shift the transmission if the rear wheels are spinning due to loss of traction. Damage to the transmission may occur.

**NOTE:**

During cold weather, you may experience increased effort in shifting until the transmission fluid warms up. This is normal.

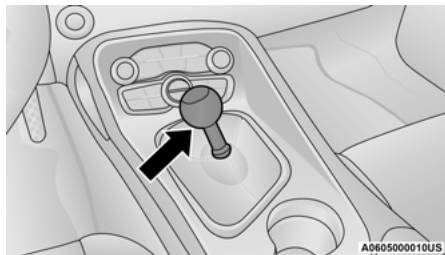

**Manual Gear Selector**

**SHIFTING**

Fully press the clutch pedal and lift your foot off the accelerator pedal before shifting gears. As you release the clutch pedal, lightly press the accelerator pedal. Damage to the transmission or clutch may occur if you do not fully press the clutch pedal and lift off of the accelerator pedal when shifting.

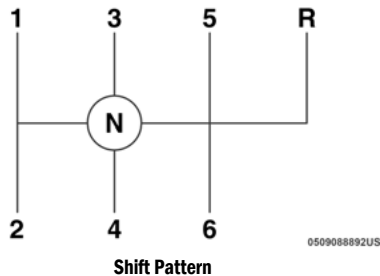

The six-speed manual transmission has a spring that centers the gear selector near THIRD and FOURTH gear. This spring helps you know which gear you are in when you are shifting. Be careful when shifting from FIRST to SECOND or downshifting from SIXTH to FIFTH.

The spring will try to pull the gear selector toward THIRD and FOURTH gear. Make sure you move the gear selector into SECOND or FIFTH gear. If you let the gear selector move in the direction of the pulling, you may end shifting from FIRST to FOURTH or from SIXTH to THIRD gear.

**CAUTION!**

Always make sure the vehicle comes to a complete stop before shifting into REVERSE. Failure to do so may result in transmission damage.

You must always use FIRST gear (or REVERSE) when starting from a standing position.

## RECOMMENDED SHIFT SPEEDS

To utilize your manual transmission efficiently for fuel economy, it should be upshifted as listed in recommended shift speed chart.

MANUAL TRANSMISSION RECOMMENDED SHIFT SPEEDS				
Axle Ratio		1-4	4-5	5-6
3.90	mph	20	37	48
	km/h	32	59	77

Earlier upshifts during cruise conditions (relatively steady speeds) may result in increased fuel economy.

Higher upshift speeds may be used to obtain a desired acceleration rate.

### NOTE:

- Your vehicle is equipped with a transmission reverse inhibitor system. Always depress the clutch pedal fully to the floor before shifting into REVERSE. When vehicle speed is greater than 3 mph (5 km/h), the reverse inhibitor activates to help prevent shifts into REVERSE. When at a complete stop, you may notice lighter shift efforts into REVERSE with the ignition switch in the ON position (RUN position for Keyless Enter 'n Go™), as compared to the ignition LOCK position (OFF position for Keyless Enter 'n Go™). This is normal operation of the transmission reverse inhibitor system.

- Due to the high performance nature of your drivetrain, you may hear your transmission. This can be most noticeable when the vehicle is idling in NEUTRAL with the clutch engaged (clutch pedal released), but it may also be heard when driving at low engine RPM. Also, this may be more noticeable when the transmission is warm. This is a normal condition and is not an indication of a problem with your clutch or transmission.

## 1-4 SKIP SHIFT

In Auto Drive Mode, Default, or Street Drive Modes, there are times when you must shift the transmission directly from FIRST gear to FOURTH gear instead of from FIRST gear to SECOND gear. This is to help you get the best possible fuel economy from your vehicle. This occurs when the engine coolant (antifreeze) is higher than 106° F (41° C), vehicle speed is greater than 19 mph (30 km/h) but less than 21 mph (34 km/h), and the transmission is in FIRST gear, and the accelerator is at ¼ throttle or less.

After you shift the transmission to FOURTH gear, you can press the clutch in and shift to another forward gear.

## DOWNSHIFTING

To maintain a safe speed and prolong brake life, downshift to maintain a safe speed when descending a steep grade.

### WARNING!

Skipping more than one gear while downshifting, could cause you to lose control of your vehicle. You could have a collision.

### CAUTION!

- If you skip more than one gear while downshifting or downshift at too high an engine speed, you could damage the engine, transmission, or clutch.
- Do not downshift into FIRST gear when the vehicle is moving faster than 15 mph (24 km/h), as you could damage the engine and/or clutch.

## AUTOMATIC TRANSMISSION — IF EQUIPPED

You must press and hold the brake pedal while shifting out of PARK.

### WARNING!

- Never use the PARK position as a substitute for the parking brake. Always apply the parking brake fully when exiting the vehicle to guard against vehicle movement and possible injury or damage.
- Your vehicle could move and injure you and others if it is not in PARK. Check by trying to move the transmission gear selector out of PARK with the brake pedal released. Make sure the transmission is in PARK before exiting the vehicle.
- The transmission may not engage PARK if the vehicle is moving. Always bring the vehicle to a complete stop before shifting to PARK, and verify that the transmission gear position indicator solidly indicates PARK (P) without blinking. Ensure that the vehicle is completely stopped, and the PARK position is properly indicated, before exiting the vehicle.

*(Continued)*

### WARNING!

- It is dangerous to shift out of PARK or NEUTRAL if the engine speed is higher than idle speed. If your foot is not firmly pressing the brake pedal, the vehicle could accelerate quickly forward or in reverse. You could lose control of the vehicle and hit someone or something. Only shift into gear when the engine is idling normally and your foot is firmly pressing the brake pedal.
- Unintended movement of a vehicle could injure those in or near the vehicle. As with all vehicles, you should never exit a vehicle while the engine is running. Before exiting a vehicle, always come to a complete stop, then apply the parking brake, shift the transmission into PARK, and turn the ignition OFF. When the ignition is in the OFF mode, the transmission is locked in PARK, securing the vehicle against unwanted movement.
- When exiting the vehicle, always make sure the ignition is in the OFF mode, remove the key fob from the vehicle, and lock the vehicle.

*(Continued)*

**WARNING!**

- Never leave children alone in a vehicle, or with access to an unlocked vehicle. Allowing children to be in a vehicle unattended is dangerous for a number of reasons. A child or others could be seriously or fatally injured. Children should be warned not to touch the parking brake, brake pedal or the transmission gear selector.
- Do not leave the key fob in or near the vehicle (or in a location accessible to children), and do not leave the ignition in the ACC or ON/RUN mode. A child could operate power windows, other controls, or move the vehicle.

**CAUTION!**

- Shift into or out of PARK or REVERSE only after the vehicle has come to a complete stop.
- Do not shift between PARK, REVERSE, NEUTRAL, or DRIVE when the engine is above idle speed.
- Before shifting into any gear, make sure your foot is firmly pressing the brake pedal.

**IGNITION PARK INTERLOCK**

This vehicle is equipped with an Ignition Park Interlock which requires the transmission to be in PARK before the ignition can be turned to the OFF mode. This helps the driver avoid inadvertently leaving the vehicle without placing the transmission in PARK. This system also locks the transmission in PARK whenever the ignition is in the OFF mode.

**NOTE:**

The transmission is NOT locked in PARK when the ignition is in the ACC mode (even though the engine will be off). Ensure that the transmission is in PARK, and the ignition is **OFF** (not in ACC mode) before exiting the vehicle.

**BRAKE TRANSMISSION SHIFT INTERLOCK (BTSI) SYSTEM**

This vehicle is equipped with a BTSI system that holds the transmission gear selector in PARK unless the brakes are applied. To shift the transmission out of PARK, the engine must be running and the brake pedal must be pressed. The brake pedal must also be pressed to shift from NEUTRAL into DRIVE or REVERSE when the vehicle is stopped or moving at low speeds.

**EIGHT-SPEED AUTOMATIC TRANSMISSION**

The transmission gear range is displayed both on the gear selector and in the instrument cluster. To select a gear range, push the lock button on the gear selector and move the selector rearward or forward. To shift the transmission out of PARK, the engine must be running and the brake pedal must be pressed. You must also press the brake pedal to shift from NEUTRAL into DRIVE or REVERSE when the vehicle is stopped or moving at low speeds. Select the DRIVE range for normal driving.

**NOTE:**

- The transmission electronics are self-calibrating; therefore, the first few shifts on a new vehicle may be somewhat abrupt. This is a normal condition, and precision shifts will develop within a few hundred miles (kilometers).
- In the event of a mismatch between the gear selector position and the actual transmission gear (for example, driver selects PARK while driving), the position indicator will blink continuously until the selector is returned to the proper position, or the requested shift can be completed.

The electronically-controlled transmission adapts its shift schedule based on driver inputs, along with environmental and road conditions.

Only shift from DRIVE to PARK or REVERSE when the accelerator pedal is released and the vehicle is stopped. Be sure to keep your foot on the brake pedal when shifting between these gears.

The transmission gear selector provides PARK, REVERSE, NEUTRAL, DRIVE, and MANUAL (AutoStick) shift positions. Manual shifts can be made using the AutoStick shift control. Toggling the gear selector forward (-) or rearward (+) while in the MANUAL (AutoStick) position (beside the DRIVE position) will manually select the transmission gear, and will display the current gear in the instrument cluster → page 91.

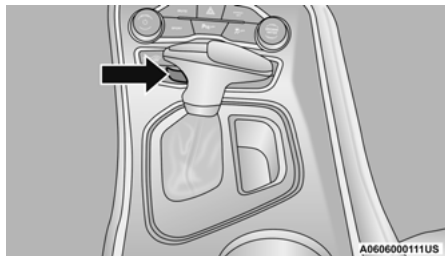

**Automatic Transmission Gear Selector**

**NOTE:**

If the gear selector cannot be moved to the PARK, REVERSE, or NEUTRAL position (when pushed forward) it is probably in the MANUAL (AutoStick, +/-) position (beside the DRIVE position). In MANUAL (AutoStick) mode, the transmission gear is displayed in the instrument cluster (as M1, M2, M3, etc.). Move the gear selector to the right (into the DRIVE [D] position) for access to PARK, REVERSE, and NEUTRAL.

**Gear Ranges**

Do not press the accelerator pedal when shifting out of PARK (P) or NEUTRAL (N).

**NOTE:**

After selecting any gear range, wait a moment to allow the selected gear to engage before accelerating. This is especially important when the engine is cold.

**PARK (P)**

This range supplements the parking brake by locking the transmission. The engine can be started in this range. Never attempt to use PARK while the vehicle is in motion. Apply the parking brake when exiting the vehicle in this range.

When parking on a hill, apply the parking brake before shifting the transmission to PARK. As an added precaution, turn the front wheels toward the curb on a downhill grade and away from the curb on an uphill grade.

When exiting the vehicle, always:

- Apply the parking brake.
- Shift the transmission into PARK.
- Turn the ignition OFF.
- Remove the key fob from the vehicle.

**WARNING!**

- Never use the PARK position as a substitute for the parking brake. Always apply the parking brake fully when exiting the vehicle to guard against vehicle movement and possible injury or damage.
- Your vehicle could move and injure you and others if it is not in PARK. Check by trying to move the transmission gear selector out of PARK with the brake pedal released. Make sure the transmission is in PARK before exiting the vehicle.
- The transmission may not engage PARK if the vehicle is moving. Always bring the vehicle to a complete stop before shifting to PARK, and verify that the transmission gear position indicator solidly indicates PARK (P) without blinking. Ensure that the vehicle is completely stopped, and the PARK position is properly indicated, before exiting the vehicle.

*(Continued)*

**WARNING!**

- It is dangerous to shift out of PARK or NEUTRAL if the engine speed is higher than idle speed. If your foot is not firmly pressing the brake pedal, the vehicle could accelerate quickly forward or in reverse. You could lose control of the vehicle and hit someone or something. Only shift into gear when the engine is idling normally and your foot is firmly pressing the brake pedal.
- Unintended movement of a vehicle could injure those in or near the vehicle. As with all vehicles, you should never exit a vehicle while the engine is running. Before exiting a vehicle, always come to a complete stop, then apply the parking brake, shift the transmission into PARK, and turn the ignition OFF. When the ignition is in the OFF mode, the transmission is locked in PARK, securing the vehicle against unwanted movement.
- When exiting the vehicle, always make sure the ignition is in the OFF mode, remove the key fob from the vehicle, and lock the vehicle.

*(Continued)***WARNING!**

- Never leave children alone in a vehicle, or with access to an unlocked vehicle. Allowing children to be in a vehicle unattended is dangerous for a number of reasons. A child or others could be seriously or fatally injured. Children should be warned not to touch the parking brake, brake pedal or the transmission gear selector.
- Do not leave the key fob in or near the vehicle (or in a location accessible to children), and do not leave the ignition in the ACC or ON/RUN mode. A child could operate power windows, other controls, or move the vehicle.

**CAUTION!**

- Before moving the transmission gear selector out of PARK, you must start the engine, and also press the brake pedal. Otherwise, damage to the gear selector could result.
- DO NOT race the engine when shifting from PARK or NEUTRAL into another gear range, as this can damage the drivetrain.

The following indicators should be used to ensure that you have properly engaged the transmission into the PARK position:

- When shifting into PARK, push the lock button on the gear selector and firmly move the selector all the way forward until it stops and is fully seated.
- Look at the transmission gear position display and verify that it indicates the PARK position (P), and is not blinking.
- With the brake pedal released, verify that the gear selector will not move out of PARK.

**REVERSE (R)**

This range is for moving the vehicle backward. Shift into REVERSE only after the vehicle has come to a complete stop.

**NEUTRAL (N)**

Use this range when the vehicle is standing for prolonged periods with the engine running. Apply the parking brake and shift the transmission into PARK if you must exit the vehicle.

**WARNING!**

Do not coast in NEUTRAL and never turn off the ignition to coast down a hill. These are unsafe practices that limit your response to changing traffic or road conditions. You might lose control of the vehicle and have a collision.

**CAUTION!**

Towing the vehicle, coasting, or driving for any other reason with the transmission in NEUTRAL can cause severe transmission damage.

For Recreational Towing ↪ page 116.

For Towing A Disabled Vehicle ↪ page 249.

**DRIVE (D)**

This range should be used for most city and highway driving. It provides the smoothest upshifts and downshifts, and the best fuel economy. The transmission automatically upshifts through all forward gears.

When frequent transmission shifting occurs (such as when operating the vehicle under heavy loading conditions, in hilly terrain, traveling into strong head winds, or while towing a heavy trailer), use the AutoStick shift control to select a lower gear ↪ page 91. Under these conditions, using a lower

gear will improve performance and extend transmission life by reducing excessive shifting and heat build-up.

During cold temperatures, transmission operation may be modified depending on engine and transmission temperature as well as vehicle speed. This feature improves warm up time of the engine and transmission to achieve maximum efficiency. Engagement of the torque converter clutch is inhibited until the transmission fluid is warm. Normal operation will resume once the transmission temperature has risen to a suitable level.

**MANUAL (M)**

The MANUAL (M, +/-) position (beside the DRIVE position) enables full manual control of transmission shifting (also known as AutoStick mode) ↪ page 91. Toggling the gear selector forward (-) or rearward (+) while in the MANUAL (AutoStick) position will manually select the transmission gear, and will display the current gear in the instrument cluster as M1, M2, M3, etc.

**Transmission Limp Home Mode**

Transmission function is monitored electronically for abnormal conditions. If a condition is detected that could result in transmission damage, Transmission Limp Home Mode is activated. In this mode, the transmission may operate only in certain gears, or may not shift at all. Vehicle

performance may be severely degraded and the engine may stall. In some situations, the transmission may not re-engage if the engine is turned off and restarted. The Malfunction Indicator Light (MIL) may be illuminated. A message in the instrument cluster will inform the driver of the more serious conditions, and indicate what actions may be necessary.

In the event of a momentary problem, the transmission can be reset to regain all forward gears by performing the following steps:

**NOTE:**

In cases where the instrument cluster message indicates the transmission may not re-engage after engine shutdown, perform this procedure only in a desired location (preferably, at an authorized dealer).

1. Stop the vehicle.
2. Shift the transmission into PARK, if possible. If not, shift the transmission to NEUTRAL.
3. Push and hold the ignition switch until the engine turns off.
4. Wait approximately 30 seconds.
5. Restart the engine.
6. Shift into the desired gear range. If the problem is no longer detected, the transmission will return to normal operation.



**NOTE:**

Even if the transmission can be reset, we recommend that you visit an authorized dealer at your earliest possible convenience. An authorized dealer has diagnostic equipment to assess the condition of your transmission. If the transmission cannot be reset, authorized dealer service is required.

**AutoStick**

AutoStick is a driver-interactive transmission feature providing manual shift control, giving you more control of the vehicle. AutoStick allows you to maximize engine braking, eliminate undesirable upshifts and downshifts, and improve overall vehicle performance. This system can also provide you with more control during passing, city driving, cold slippery conditions, mountain driving, trailer towing, and many other situations.

**Operation**

In AutoStick mode, you can use the gear selector (in the MANUAL position), or the shift paddles to the MANUAL (M) position (beside the DRIVE (D) position), or tap one of the shift paddles on the steering wheel. Tapping the (-) shift paddle to enter AutoStick mode will downshift the transmission to the next lower gear, while tapping (+) to enter AutoStick mode will retain the current gear. The current transmission gear will be displayed in the instrument cluster.

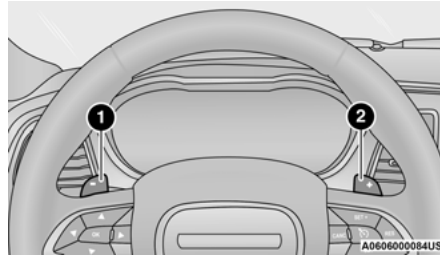
**Shifter Paddles**

- 1 – (-) Shift Paddle
- 2 – (+) Shift Paddle

**NOTE:**

- Tapping one of the steering wheel-mounted shift paddles (+/-) (if equipped), while the gear selector is in DRIVE, will activate a temporary AutoStick mode. Tapping (-) to enter AutoStick mode will downshift the transmission to the next lower gear, while tapping (+) to enter AutoStick mode will retain the current gear. The current gear will be displayed in the instrument cluster, but the “M” will not be highlighted. The transmission will revert back to normal operation (if the gear selector remains in DRIVE) after a period of time, depending on accelerator pedal activity.

- In some models, the shift paddles may be disabled (or re-enabled, as desired) using Drive Mode Set-Up, accessed by selecting Performance Control.

In AutoStick mode, the transmission will shift up or down when (+/-) is manually selected by the driver (using the gear selector, or the shift paddles [if equipped]), unless an engine lugging or overspeed condition would result. It will remain in the selected gear until another upshift or downshift is chosen, except as follows:

- In temporary AutoStick mode (gear selector in DRIVE), the transmission will automatically shift up when maximum engine speed is reached. If the accelerator is fully pressed, the transmission will downshift when possible. Lack of accelerator pedal activity will cause the transmission to revert to automatic operation.
- If normal AutoStick mode is engaged (gear selector in MANUAL position), manual gear selection will be maintained until the gear selector is returned to DRIVE, or as described below. The transmission will not upshift automatically at redline in this mode, nor will downshifts be obtained if the accelerator pedal is pressed to the floor.
- The transmission will automatically downshift as the vehicle slows (to prevent engine lugging) and will display the current gear.

- The transmission will automatically downshift to FIRST gear when coming to a stop. After a stop, the driver should manually upshift (+) the transmission as the vehicle is accelerated.
- You can start out, from a stop, in FIRST or SECOND gear. Tapping (+) (at a stop) will allow starting in SECOND gear. Starting out in SECOND gear can be helpful in snowy or icy conditions.
- If a requested downshift would cause the engine to over-speed, that shift will not occur and an indication will display.
- The system will ignore attempts to upshift at too low of a vehicle speed and an indication will display.
- Holding the (-) paddle pressed (if equipped), or holding the gear selector in the (-) position, will downshift the transmission to the lowest gear possible at the current speed.
- Transmission shifting will be more noticeable when AutoStick is enabled.
- The system may revert to automatic shift mode if a fault or overheat condition is detected.

To disengage AutoStick mode, return the gear selector to the DRIVE position, or press and hold the (+) shift paddle (if equipped, and the gear selector is already in DRIVE) until “D” is once again

indicated in the instrument cluster. You can shift in or out of the AutoStick mode at any time without taking your foot off the accelerator pedal.

#### WARNING!

Do not downshift for additional engine braking on a slippery surface. The drive wheels could lose their grip and the vehicle could skid, causing a collision or personal injury.

## SPORT MODE — WITHOUT PERFORMANCE CONTROL

Your vehicle is equipped with a SPORT Mode feature. This mode is a configuration set up for typical enthusiast driving. The engine, transmission (when equipped with automatic transmission), and steering systems are all set to their SPORT settings. SPORT Mode will provide improved throttle response and modified shifting for an enhanced driving experience, as well the greatest amount of steering feel. This mode may be activated and deactivated by pushing the SPORT button on the instrument panel switch bank.

#### NOTE:

If equipped with a manual transmission, the 1 - 4 Skip Shift Feature is disabled in SPORT Mode.

## FUEL SAVER TECHNOLOGY 5.7L — IF EQUIPPED

This feature offers improved fuel economy by shutting off four of the engine's eight cylinders during light load and cruise conditions. The system is automatic with no driver inputs or additional driving skills required. When the system is active, an indication will display within the instrument cluster “Fuel Economy” main menu screen.

#### NOTE:

This system may take some time to return to full functionality after a battery disconnect.

## ELECTRIC POWER STEERING

The Electric Power Steering system provides increased vehicle response and ease of maneuverability. The system adapts to different driving conditions. If the electric steering system experiences a fault that prevents it from providing assist, you will still have the ability to steer the vehicle manually.

#### WARNING!

Continued operation with reduced assist could pose a safety risk to yourself and others. Service should be obtained as soon as possible.

Alternate electric power steering efforts can be selected through the Uconnect System  
 ↗ page 120.

If the Electric Power Steering warning icon is displayed and the “SERVICE POWER STEERING” or the “POWER STEERING ASSIST OFF – SERVICE SYSTEM” message is displayed within the instrument cluster display, this indicates the vehicle needs to be taken to the dealer for service  
 ↗ page 69.

#### NOTE:

- Even if the power steering assistance is no longer operational, it is still possible to steer the vehicle. Under these conditions there will be a substantial increase in steering effort, especially at low speeds and during parking maneuvers.
- If the condition persists, see an authorized dealer for service.

If the Steering icon is displayed and the “POWER STEERING SYSTEM OVER TEMP” message is displayed on the instrument cluster screen, they indicate that extreme steering maneuvers may have occurred which caused an over temperature condition in the power steering system. Once driving conditions are safe, pull over and let the vehicle idle for a few moments until the icon and message turn off.

## CRUISE CONTROL SYSTEMS — IF EQUIPPED

Your vehicle may be equipped with the Cruise Control system, or the Adaptive Cruise Control (ACC) system:

- Cruise Control will keep your vehicle at a constant preset speed.
- Adaptive Cruise Control (ACC) will adjust the vehicle speed up to the preset speed to maintain a distance with the vehicle ahead.

#### NOTE:

- In vehicles equipped with ACC, if ACC is not enabled, Fixed Speed Cruise Control will not detect vehicles directly ahead of you. Always be aware of the feature selected.
- Only one Cruise Control feature can operate at a time. For example, if Fixed Speed Cruise Control is enabled, Adaptive Cruise Control will be unavailable, and vice versa.

## CRUISE CONTROL

When engaged, the Cruise Control takes over accelerator operations at speeds greater than 25 mph (40 km/h) or 20 mph (32 km/h), depending on engine size and axle ratio.

The Cruise Control buttons are located on the right side of the steering wheel.

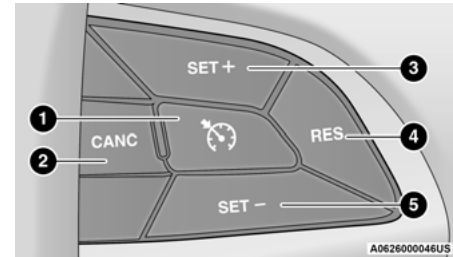

Cruise Control Buttons

- 1 — On/Off
- 2 — CANC/Cancel
- 3 — SET (+)/Accel
- 4 — RES/Resume
- 5 — SET (-)/Decel

#### WARNING!

Cruise Control can be dangerous where the system cannot maintain a constant speed. Your vehicle could go too fast for the conditions, and you could lose control and have an accident. Do not use Cruise Control in heavy traffic or on roads that are winding, icy, snow-covered or slippery.

## To Activate

Push the on/off button to activate the Cruise Control. "CRUISE CONTROL READY" will appear in the instrument cluster display to indicate the Cruise Control is on. To turn the system off, push the on/off button a second time. "CRUISE CONTROL OFF" will appear in the instrument cluster display to indicate the Cruise Control is off. The system should be turned off when not in use.

### WARNING!

Leaving the Cruise Control system on when not in use is dangerous. You could accidentally set the system or cause it to go faster than you want. You could lose control and have an accident. Always ensure the system is OFF when you are not using it.

## To Set A Desired Speed

Turn the Cruise Control on. When the vehicle has reached the desired speed, push the SET (+) or SET (-) button and release. Release the accelerator and the vehicle will operate at the selected speed. Once a speed has been set, a message "CRUISE CONTROL SET TO MPH (km/h)" will appear indicating what speed was set. A cruise indicator lamp, along with set speed will also appear and stay on in the instrument cluster when the speed is set.

## To Vary The Speed Setting

### To Increase Or Decrease The Set Speed

When the Cruise Control is set, you can increase speed by pushing the SET (+) button, or decrease speed by pushing the SET (-) button.

### U.S. Speed (mph)

- Pushing the SET (+), or SET (-) button once will result in a 1 mph speed adjustment. Each subsequent tap of the button results in an adjustment of 1 mph.
- If the button is continually pushed, the set speed will continue to adjust until the button is released, then the new set speed will be established.

### Metric Speed (km/h)

- Pushing the SET (+), or SET (-) button once will result in a 1 km/h speed adjustment. Each subsequent tap of the button results in an adjustment of 1 km/h.
- If the button is continually pushed, the set speed will continue to adjust until the button is released, then the new set speed will be established.

## To Accelerate For Passing

While the Cruise Control system is set, press the accelerator to pass as you would normally. When the pedal is released, the vehicle will return to the set speed.

## USING CRUISE CONTROL ON HILLS

The transmission may downshift on hills to maintain the vehicle set speed.

The Cruise Control system maintains speed up and down hills. A slight speed change on moderate hills is normal. On steep hills, a greater speed loss or gain may occur so it may be preferable to drive without Cruise Control.

### WARNING!

Cruise Control can be dangerous where the system cannot maintain a constant speed. Your vehicle could go too fast for the conditions, and you could lose control and have an accident. Do not use Cruise Control in heavy traffic or on roads that are winding, icy, snow-covered or slippery.

## To Resume Speed

To resume a previously set speed, push the RES button and release. Resume can be used at any speed above 20 mph (32 km/h).

## To Deactivate

A tap on the brake pedal, pushing the CANC button, or normal brake pressure will deactivate the Cruise Control system without erasing the set speed from memory.

Pushing the on/off button or placing the ignition in the OFF position erases the set speed from memory.

The following conditions will also deactivate the Cruise Control without erasing the set speed from memory:

- Vehicle parking brake is applied
- Stability event occurs
- Gear selector is moved out of DRIVE
- Engine overspeed occurs
- Clutch pedal is pressed (manual transmission only)

## ADAPTIVE CRUISE CONTROL (ACC)

Adaptive Cruise Control (ACC) increases the driving convenience provided by Cruise Control while traveling on highways and major roadways. However, it is not a safety system and not designed to prevent collisions. The Cruise Control function performs differently ↗ page 93.

ACC will allow you to keep Cruise Control engaged in light to moderate traffic conditions without the constant need to reset your Cruise Control. ACC utilizes a radar sensor and a forward facing camera designed to detect a vehicle directly ahead of you to maintain a set speed.

### NOTE:

- If the ACC sensor detects a vehicle ahead, ACC will apply limited braking or accelerate (not to exceed the original set speed) automatically to maintain a preset following distance, while matching the speed of the vehicle ahead.
- Any chassis/suspension or tire size modifications to the vehicle will affect the performance of the Adaptive Cruise Control and Forward Collision Warning system.
- Fixed Speed Cruise Control (ACC not enabled) will not detect vehicles directly ahead of you. Always be aware of the feature selected ↗ page 318.

### WARNING!

- Adaptive Cruise Control (ACC) is a convenience system. It is not a substitute for active driver involvement. It is always the driver's responsibility to be attentive of road, traffic, and weather conditions, vehicle speed, distance to the vehicle ahead and, most importantly, brake operation to ensure safe operation of the vehicle under all road conditions. Your complete attention is always required while driving to maintain safe control of your vehicle. Failure to follow these warnings can result in a collision and death or serious personal injury.

(Continued)

### WARNING!

- The ACC system:
  - Does not react to pedestrians, oncoming vehicles, and stationary objects (e.g., a stopped vehicle in a traffic jam or a disabled vehicle).
  - Cannot take street, traffic, and weather conditions into account, and may be limited upon adverse sight distance conditions.
  - Does not always fully recognize complex driving conditions, which can result in wrong or missing distance warnings.

You should switch off the ACC system:

- When driving in fog, heavy rain, heavy snow, sleet, heavy traffic, and complex driving situations (i.e., in highway construction zones).
- When entering a turn lane or highway off-ramp; when driving on roads that are winding, icy, snow-covered, slippery, or have steep uphill or downhill slopes.
- When towing a trailer up or down steep slopes.
- When circumstances do not allow safe driving at a constant speed.

## Adaptive Cruise Control (ACC) Operation

The Cruise Control buttons (located on the right side of the steering wheel) operate the Adaptive Cruise Control (ACC) system.

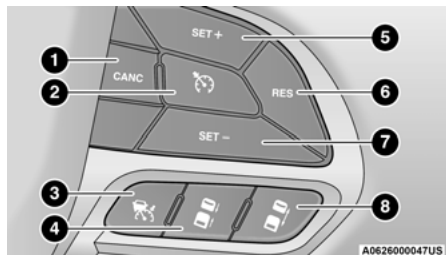

**Adaptive Cruise Control Buttons**

- 1 — CANCEL/Cancel
- 2 — Fixed Speed Cruise Control On/Off
- 3 — Adaptive Cruise Control (ACC) On/Off
- 4 — Distance Decrease
- 5 — SET (+)/Accel
- 6 — RES/Resume
- 7 — SET (-)/Decel
- 8 — Distance Increase

## Adaptive Cruise Control (ACC) Menu

The instrument cluster display shows the current ACC system settings. The information it displays depends on ACC system status.

Push the Adaptive Cruise Control (ACC) on/off button until one of the following appears in the instrument cluster display:

### Adaptive Cruise Control Off

When ACC is deactivated, the display will read “Adaptive Cruise Control Off.”

### Adaptive Cruise Control Ready

When ACC is activated, but the vehicle speed setting has not been selected, the display will read “Adaptive Cruise Control Ready.”

### Adaptive Cruise Control Set

When the SET (+) or the SET (-) button is pushed, the display will read “ACC SET.”

When ACC is set, the set speed will show in the instrument cluster display.

The ACC screen may display once again if any of the following ACC activity occurs:

- System Cancel
- Driver Override
- System Off

- ACC Proximity Warning
- ACC Unavailable Warning

The instrument cluster display will return to the last display selected after five seconds of no ACC display activity

## Activating Adaptive Cruise Control (ACC)

The minimum set speed for the ACC system is 20 mph (32 km/h).

The system will cancel when the vehicle speed drops below 15 mph (24 km/h).

When the system is turned on and in the ready state, the instrument cluster displays “ACC Ready.”

When the system is off, the instrument cluster displays “Adaptive Cruise Control (ACC) Off.”

### NOTE:

You cannot engage ACC under the following conditions:

- When the brakes are applied.
- When the parking brake is applied.
- When the automatic transmission is in PARK, REVERSE or NEUTRAL.
- When the vehicle speed is below the minimum speed range.
- When the brakes are overheated.

## To Activate/Deactivate

Push and release the Adaptive Cruise Control (ACC) on/off button. The ACC menu in the instrument cluster displays “ACC Ready.”

To turn the system off, push and release the Adaptive Cruise Control (ACC) on/off button again. At this time, the system will turn off and the instrument cluster displays “Adaptive Cruise Control (ACC) Off.”

### WARNING!

Leaving the Adaptive Cruise Control (ACC) system on when not in use is dangerous. You could accidentally set the system or cause it to go faster than you want. You could lose control and have a collision. Always ensure the system is off when you are not using it.

## To Set A Desired ACC Speed

When the vehicle reaches the speed desired, push the SET (+) button or the SET (-) button and release. The instrument cluster display will show the set speed.

### NOTE:

Fixed Speed Cruise Control can be used without ACC enabled. To change between the different modes, push the ACC on/off button which turns the ACC and the Fixed Speed Cruise Control off. Pushing the Fixed Speed Cruise Control on/off button will result in turning on (changing to) Fixed Speed Cruise Control mode.

### WARNING!

In Fixed Speed Cruise Control mode, the system will not react to vehicles ahead. In addition, the proximity warning does not activate and no alarm will sound even if you are too close to the vehicle ahead since neither the presence of the vehicle ahead nor the vehicle-to-vehicle distance is detected. Be sure to maintain a safe distance between your vehicle and the vehicle ahead. Always be aware which mode is selected.

If ACC is set when the vehicle speed is below 20 mph (32 km/h), the set speed will default to 20 mph (32 km/h).

### NOTE:

Fixed Speed Cruise Control cannot be set below 20 mph (32 km/h).  
If either system is set when the vehicle speed is above 20 mph (32 km/h), the set speed shall be the current speed of the vehicle.

### NOTE:

- Keeping your foot on the accelerator pedal can cause the vehicle to continue to accelerate beyond the set speed. If this occurs, the message “DRIVER OVERRIDE” will display in the instrument cluster display.
- If you continue to accelerate beyond the set speed while ACC is enabled, the system will not be controlling the distance between your vehicle and the vehicle ahead. The vehicle speed will only be determined by the position of the accelerator pedal.

## To Cancel

The following conditions cancel the ACC or Fixed Speed Cruise Control systems:

- The brake pedal is applied.
- The parking brake is applied.
- The CANC (cancel) button is pushed.
- An Anti-Lock Brake System (ABS) event occurs.
- The gear selector is removed from the DRIVE position.
- The Electronic Stability Control/Traction Control System (ESC/TCS) activates.

The following conditions will only cancel the ACC system:

- The vehicle speed goes below 15 mph (24 km/h).

## To Turn Off

The system will turn off and erase the set speed in memory if:

- The Adaptive Cruise Control (ACC) on/off button is pushed
- The Fixed Speed Cruise Control on/off button is pushed
- The ignition is placed in the OFF position

## To Resume

If there is a set speed in memory, push the RES (resume) button and remove your foot from the accelerator pedal. The instrument cluster display will show the last set speed.

Resume can be used at any speed above 20 mph (32 km/h) when only Fixed Speed Cruise Control is being used.

Resume can be used at any speed above 0 mph (0 km/h) when ACC is active.

### WARNING!

The Resume function should only be used if traffic and road conditions permit. Resuming a set speed that is too high or too low for prevailing traffic and road conditions could cause the vehicle to accelerate or decelerate too sharply for safe operation. Failure to follow these warnings can result in a collision and death or serious personal injury.

## To Vary The Speed Setting

### To Increase Or Decrease The Set Speed

While ACC is set, you can increase speed by pushing the SET (+) button, or decrease speed by pushing the SET (-) button.

### U.S. Speed (mph)

- Pushing the SET (+), or SET (-) button once will result in a 1 mph speed adjustment. Each subsequent tap of the button results in an adjustment of 1 mph.
- If the button is continually pushed, the set speed will continue to adjust in 5 mph increments until the button is released. The new set speed is reflected in the instrument cluster display.

### Metric Speed (km/h)

- Pushing the SET (+), or SET (-) button once will result in a 1 km/h speed adjustment. Each subsequent tap of the button results in an adjustment of 1 km/h.
- If the button is continually pushed, the set speed will continue to adjust in 10 km/h increments until the button is released. The new set speed is reflected in the instrument cluster display.

## NOTE:

When you override and push the SET (+) button or SET (-) button, the new set speed will be the current speed of the vehicle.

### When ACC Is Active:

- When you use the SET (-) button to decelerate, if the engine's braking power does not slow the vehicle sufficiently to reach the set speed, the brake system will automatically slow the vehicle.
- The ACC system applies the brake down to 15 mph (24 km/h) when following a vehicle ahead.
- The ACC system maintains set speed when driving uphill and downhill. However, a slight speed change on moderate hills is normal. In addition, downshifting may occur while climbing uphill or descending downhill. This is normal operation and necessary to maintain set speed. When driving uphill and downhill, the ACC system will cancel if the braking temperature exceeds normal range (overheated).



## Setting The Following Distance In ACC

The specified following distance for ACC can be set by varying the distance setting between four bars (longest), three bars (long), two bars (medium) and one bar (short). Using this distance setting and the vehicle speed, ACC calculates and sets the distance to the vehicle ahead. This distance setting will show in the instrument cluster display.

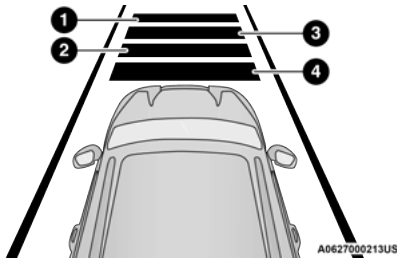

Distance Settings

- 1 — Longest Distance Setting (Four Bars)
- 2 — Medium Distance Setting (Two Bars)
- 3 — Long Distance Setting (Three Bars)
- 4 — Short Distance Setting (One Bar)

To increase the distance setting, push the Distance Setting Increase button and release. Each time the button is pushed, the distance setting increases by one bar (longer).

To decrease the distance setting, push the Distance Setting Decrease button and release. Each time the button is pushed, the distance setting decreases by one bar (shorter).

If there is no vehicle ahead, the vehicle will maintain the set speed. If a slower moving vehicle is detected in the same lane, the instrument cluster display will show the Adaptive Cruise Control (ACC) Set With Target Vehicle Light, and the system adjusts vehicle speed automatically to maintain the distance setting, regardless of the set speed.

The vehicle will then maintain the set distance until:

- The vehicle ahead accelerates to a speed above the set speed.
- The vehicle ahead moves out of your lane or view of the sensor.
- The distance setting is changed.
- The system disengages → page 96.

The maximum braking applied by ACC is limited; however, the driver can always apply the brakes manually, if necessary.

### NOTE:

The brake lights will illuminate whenever the ACC system applies the brakes.

A Proximity Warning will alert the driver if ACC predicts that its maximum braking level is not sufficient to maintain the set distance. If this occurs, a visual alert “BRAKE!” will flash in the instrument cluster display and a chime will sound while ACC continues to apply its maximum braking capacity.

### NOTE:

The “BRAKE!” screen in the instrument cluster display is a warning for the driver to take action and does not necessarily mean that the Forward Collision Warning system is applying the brakes autonomously.

### Overtake Aid

When driving with ACC engaged and following a vehicle, the system will provide an additional acceleration up to the ACC set speed to assist in passing the vehicle. This additional acceleration is triggered when the driver utilizes the left turn signal and will only be active when passing on the left hand side.

## Display Warnings And Maintenance

### “WIPE FRONT RADAR SENSOR IN FRONT OF VEHICLE” WARNING

The “ACC/FCW Unavailable Wipe Front Radar Sensor” warning will display and a chime will sound when conditions temporarily limit system performance.

This most often occurs at times of poor visibility, such as in snow or heavy rain. The ACC system may also become temporarily blinded due to obstructions, such as mud, dirt or ice. In these cases, the instrument cluster display will display “ACC/FCW Unavailable Wipe Front Radar Sensor” and the system will deactivate.

The “ACC/FCW Unavailable Wipe Front Radar Sensor” message can sometimes be displayed while driving in highly reflective areas (i.e. tunnels with reflective tiles, or ice and snow). The ACC system will recover after the vehicle has left these areas. Under rare conditions, when the radar is not tracking any vehicles or objects in its path this warning may temporarily occur.

#### NOTE:

If the “ACC/FCW Unavailable Wipe Front Radar Sensor” warning is active, Fixed Speed Cruise Control is still available.

If weather conditions are not a factor, the driver should examine the sensor. It may require cleaning or removal of an obstruction. The sensor is located in the center of the vehicle behind the lower grille.

To keep the ACC system operating properly, it is important to note the following maintenance items:

- Always keep the sensor clean. Carefully wipe the sensor lens with a soft cloth. Be cautious not to damage the sensor lens.
- Do not remove any screws from the sensor. Doing so could cause an ACC system malfunction or failure and require a sensor realignment.
- If the sensor or front end of the vehicle is damaged due to a collision, see an authorized dealer for service.
- Do not attach or install any accessories near the sensor, including transparent material or aftermarket grilles. Doing so could cause an ACC system failure or malfunction.

When the condition that deactivated the system is no longer present, the system will return to the “Adaptive Cruise Control Off” state and will resume function by simply reactivating it.

#### NOTE:

- If the “ACC/FCW Unavailable Wipe Front Radar Sensor” message occurs frequently (e.g. more than once on every trip) without any snow, rain, mud, or other obstruction, have the radar sensor realigned at an authorized dealer.
- Installing a snow plow, front-end protector, an aftermarket grille or modifying the grille is not recommended. Doing so may block the sensor and inhibit ACC/FCW operation.

### SERVICE ACC/FCW WARNING

If the system turns off, and the instrument cluster displays “ACC/FCW Unavailable Service Required” or “Cruise/FCW Unavailable Service Required”, there may be an internal system fault or a temporary malfunction that limits ACC functionality. Although the vehicle is still drivable under normal conditions, ACC will be temporarily unavailable. If this occurs, try activating ACC again later, following an ignition cycle. If the problem persists, see an authorized dealer.

## Precautions While Driving With ACC

In certain driving situations, ACC may have detection issues. In these cases, ACC may brake late or unexpectedly. The driver needs to stay alert and may need to intervene. The following are examples of these types of situations:

### TOWING A TRAILER

Towing a trailer is not advised when using ACC.

### OFFSET DRIVING

ACC may not detect a vehicle in the same lane that is offset from your direct line of travel, or a vehicle merging in from a side lane. There may not be sufficient distance to the vehicle ahead. The offset vehicle may move in and out of the line of travel, which can cause your vehicle to brake or accelerate unexpectedly.

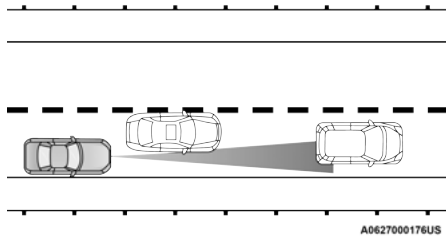

Offset Driving Condition Example

## TURNS AND BENDS

When driving on a curve with ACC engaged, the system may decrease the vehicle speed and acceleration for stability reasons, with no vehicle detected ahead. Once the vehicle is out of the curve the system will resume your original set speed. This is a part of normal ACC system functionality.

### NOTE:

On tight turns ACC performance may be limited. The driver must maintain control of the vehicle, remain alert, and be ready to apply the brakes if needed.

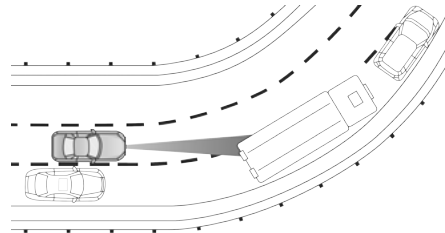

Turn Or Bend Example

## USING ACC ON HILLS

When driving on hills, ACC may not detect a vehicle in your lane. Depending on the speed, vehicle load, traffic conditions, and the steepness of the hills, ACC performance may be limited.

### NOTE:

The driver must maintain control of the vehicle, remain alert, and be ready to apply the brakes if needed.

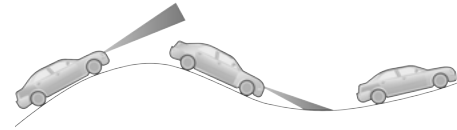

ACC Hill Example

### LANE CHANGING

ACC may not detect a vehicle until it is completely in the lane in which you are traveling. In the following lane changing example, ACC has not yet detected the vehicle changing lanes and it may not detect the vehicle until it's too late for the ACC system to take action. ACC may not detect a vehicle until it is completely in the lane. There may not be sufficient distance to the lane-changing vehicle. Always be attentive and ready to apply the brakes if necessary.

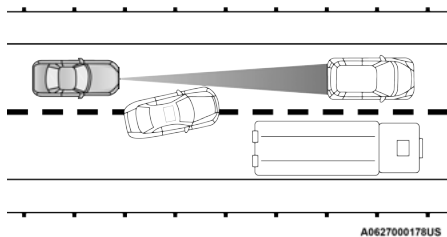

**Lane Changing Example**

### NARROW VEHICLES

Some narrow vehicles traveling near the outer edges of the lane or edging into the lane are not detected until they have moved fully into the lane. There may not be sufficient distance to the vehicle ahead.

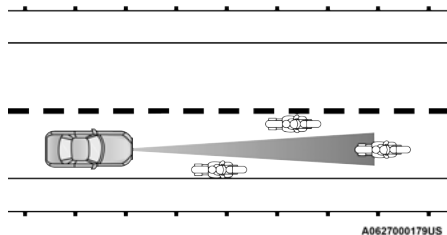

**Narrow Vehicle Example**

### STATIONARY OBJECTS AND VEHICLES

ACC does not react to stationary objects and stationary vehicles. For example, ACC will not react in situations where the vehicle you are following exits your lane and the vehicle ahead is stopped in your lane. Always be attentive and ready to apply the brakes if necessary.

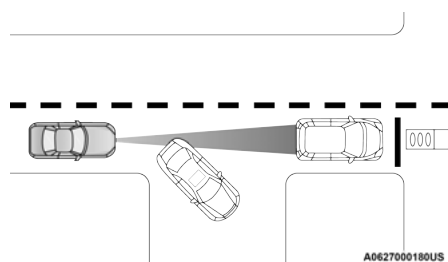

**Stationary Object And Stationary Vehicle Example**

## **PARKSENSE REAR PARK ASSIST — IF EQUIPPED**

The ParkSense Rear Park Assist system provides visual and audible indications of the distance between the rear fascia/bumper and a detected obstacle when backing up (e.g. during a parking maneuver).

For limitations of this system and recommendations, see ↗ page 106.

ParkSense will retain the last system state (enabled or disabled) from the previous ignition cycle when the ignition is changed to the ON/RUN position.

ParkSense can be active only when the gear selector is in REVERSE. If ParkSense is enabled at this gear selector position, the system will remain active until the vehicle speed is increased to approximately 7 mph (11 km/h) or above. The system will become active again if the vehicle speed is decreased to speeds less than approximately 6 mph (9 km/h).

## **PARKSENSE SENSORS**

The four ParkSense sensors, located in the rear fascia/bumper, monitor the area behind the vehicle that is within the sensors' field of view. The sensors can detect obstacles from approximately 12 inches (30 cm) up to 79 inches (200 cm) from the rear fascia/bumper in the horizontal direction, depending on the location, type and orientation of the obstacle.

## **PARKSENSE DISPLAY**

When the vehicle is in REVERSE, the warning display will turn on indicating the system status.

The system will indicate a detected obstacle by showing a single arc in one or more regions based on the obstacle's distance and location relative to the vehicle.

If an obstacle is detected in the center rear region, the display will show a single solid arc in the center rear region and will produce a one-half second tone. As the vehicle moves closer to the obstacle, the display will show the single arc moving closer to the vehicle and the sound tone will change from slow, to fast, to continuous.

If an obstacle is detected in the left and/or right rear region, the display will show a single flashing arc in the left and/or right rear region and will produce a fast sound tone. As the vehicle moves closer to the obstacle, the display will show the single arc moving closer to the vehicle and the sound tone will change from fast to continuous.

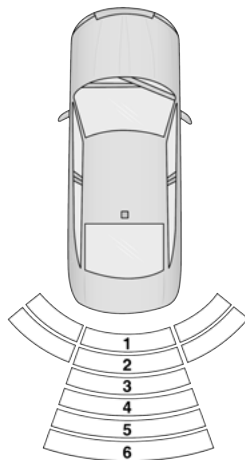

A0626000160US

**Front/Rear ParkSense Arcs**

- 1 – Continuous Tone/Flashing Arc
- 2 – Fast Tone/Flashing Arc
- 3 – Fast Tone/Flashing Arc

- 4 – Slow Tone/Solid Arc
  - 5 – Slow Tone/Solid Arc
  - 6 – Single 1/2 Second Tone/Solid Arc
-

The vehicle is close to the obstacle when the warning display shows one flashing arc and sounds a continuous tone. The following chart shows the warning alert operation when the system is detecting an obstacle:

WARNING ALERTS							
Rear Distance (inches/cm)	Greater than 79 inches (200 cm)	79-59 inches (200-150 cm)	59-47 inches (150-120 cm)	47-39 inches (120-100 cm)	39-25 inches (100-65 cm)	25-12 inches (65-30 cm)	Less than 12 inches (30 cm)
Audible Alert Chime	None	Single 1/2 Second Tone (for rear center only)	Slow (for rear center only)	Slow (for rear center only)	Fast (for rear center only)	Fast	Continuous
Arc – Left Rear	None	None	None	None	None	2nd Flashing	1st Flashing
Arc – Center Rear	None	6th Solid	5th Solid	4th Solid	3rd Flashing	2nd Flashing	1st Flashing
Arc – Right Rear	None	None	None	None	None	2nd Flashing	1st Flashing
Radio Volume Reduced	No	Yes	Yes	Yes	Yes	Yes	Yes

## PARKSENSE WARNING DISPLAY

The ParkSense Warning screen will only be displayed if Sound and Display is selected from within the Uconnect system → page 120.

The ParkSense Warning screen is located within the instrument cluster display → page 62. It provides visual warnings to indicate the distance between the rear fascia/bumper and the detected obstacle.

## ENABLING AND DISABLING PARKSENSE



ParkSense can be enabled and disabled with the ParkSense switch, located on the switch panel below the Uconnect display.

When the ParkSense switch is pushed to disable the system, the instrument cluster will display the “ParkSense Off” message for approximately five seconds. When the gear selector is moved to REVERSE and the system is disabled, the

instrument cluster display will display the “ParkSense Off” message for as long as the vehicle is in REVERSE.

The ParkSense switch LED will be on when ParkSense is disabled or requires service. The ParkSense switch LED will be off when the system is enabled. If the ParkSense switch is pushed, and the system requires service, the ParkSense switch LED will blink momentarily, and then the LED will be on.

## SERVICE THE PARKSENSE REAR PARK ASSIST SYSTEM

During vehicle start up, when the ParkSense Rear Park Assist System has detected a faulted condition, the instrument cluster will actuate a single chime, once per ignition cycle and it will display the “PARKSENSE UNAVAILABLE WIPE REAR SENSORS” or “PARKSENSE UNAVAILABLE SERVICE REQUIRED” message for five seconds.

When the gear selector is moved to REVERSE and the system has detected a faulted condition, the instrument cluster display will display the “PARKSENSE UNAVAILABLE WIPE REAR SENSORS” or “PARKSENSE UNAVAILABLE SERVICE REQUIRED” message for as long as the vehicle is in REVERSE. Under this condition, ParkSense will not operate.

If “PARKSENSE UNAVAILABLE WIPE REAR SENSORS” appears in the instrument cluster display, make sure the outer surface and the inside of the rear fascia/bumper is clean and clear of snow, ice, mud, dirt or other obstruction, and then cycle the ignition. If the message continues to appear see an authorized dealer.

If “PARKSENSE UNAVAILABLE SERVICE REQUIRED” appears in the instrument cluster display, see an authorized dealer.

## CLEANING THE PARKSENSE SYSTEM

Clean the Rear Park Assist sensors with water, car wash soap and a soft cloth. Do not use rough or hard cloths. In washing stations, clean sensors quickly keeping the vapor jet/high pressure washing nozzles at least 4 inches (10 cm) from the sensors. Do not scratch or poke the sensors. Otherwise, you could damage the sensors.

## PARKSENSE SYSTEM USAGE

### PRECAUTIONS

#### NOTE:

- Ensure that the rear fascia/bumper is free of snow, ice, mud, dirt and debris to keep the ParkSense system operating properly.
- Jackhammers, large trucks, and other vibrations could affect the performance of ParkSense or render the system temporarily unavailable.
- When you turn ParkSense off in DRIVE, the instrument cluster will display "PARKSENSE OFF" for five seconds. Furthermore, once you turn ParkSense off, it remains off until you turn it on again, even if you cycle the ignition.
- When you move the gear selector to the REVERSE position and ParkSense is turned off, the instrument cluster display will show the “PARKSENSE OFF” message for as long as the vehicle is in REVERSE.
- ParkSense will reduce the volume of the radio when it is sounding an audio tone.
- Clean the ParkSense sensors regularly, taking care not to scratch or damage them. The sensors must not be covered with ice, snow, slush, mud, dirt or debris. Failure to do so can result in the system not working properly. The ParkSense system might not detect an obstacle behind the fascia/bumper, or it could provide a false indication that an obstacle is behind the fascia/bumper.
- Ensure the ParkSense system is off if objects such as bicycle carriers, trailer hitches, etc., are placed within 12 inches (30 cm) from the rear fascia/bumper. Failure to do so can result in the system misinterpreting a close object as a sensor problem, causing the “PARKSENSE UNAVAILABLE SERVICE REQUIRED” message to be shown in the instrument cluster display.



**WARNING!**

Drivers must be careful when backing up even when using the Rear Park Assist system. Always check carefully behind your vehicle, and be sure to check for pedestrians, animals, other vehicles, obstructions, or blind spots before backing up. You are responsible for the safety of your surroundings and must continue to pay attention while backing up. Failure to do so can result in serious injury or death.

**CAUTION!**

- ParkSense is only a parking aid and it is unable to recognize every obstacle, including small obstacles. Parking curbs might be temporarily detected or not detected at all. Obstacles located above or below the sensors will not be detected when they are in close proximity.
- The vehicle must be driven slowly when using ParkSense in order to be able to stop in time when an obstacle is detected. It is recommended that the driver looks over his/her shoulder when using ParkSense.

**PARKVIEW REAR BACK UP CAMERA**

The ParkView Rear Back Up Camera allows you to see an on-screen image of the rear surroundings of your vehicle whenever the gear selector is put into REVERSE. The ParkView camera is located on the rear of the vehicle above the rear license plate. The image will be displayed in the touchscreen display along with a caution note to “Check Entire Surroundings” across the top of the screen. After five seconds, this note will disappear.

**NOTE:**

The ParkView Rear Back Up Camera has programmable modes of operation that may be selected through the Uconnect system → page 120.

If your vehicle is equipped with the Camera Delay feature and it is turned on, the rear camera image will be displayed for up to 10 seconds when the vehicle is shifted out of REVERSE. However, this feature is canceled if the forward vehicle speed exceeds 8 mph (13 km/h), the transmission is shifted into PARK, the vehicle's ignition is placed in the OFF position, or by pressing the touchscreen X button.

When the vehicle is shifted out of REVERSE with Camera Delay turned off, the rear camera mode is exited and the last touchscreen appears again.

When enabled, active guidelines are overlaid on the image to illustrate the width of the vehicle and its projected backup path based on the steering wheel position. The active guidelines will show separate zones that will help indicate the distance to the rear of the vehicle.

If the vehicle speed remains below 8 mph (13 km/h), the rear view camera image will continue to be displayed until the transmission is shifted into PARK, the vehicle's ignition is placed in the OFF position, or the touchscreen X button is pressed.

Different colored zones indicate the distance to the rear of the vehicle.

The following table shows the approximate distances for each zone:

Zone	Distance To The Rear Of The Vehicle
Red	0 - 1 ft (0 - 30 cm)
Yellow	1 ft - 6.5 ft (30 cm - 2 m)
Green	6.5 ft or greater (2 m or greater)

**WARNING!**

Drivers must be careful when backing up even when using the ParkView Rear Back Up Camera. Always check carefully behind your vehicle, and be sure to check for pedestrians, animals, other vehicles, obstructions, or blind spots before backing up. You are responsible for the safety of your surroundings and must continue to pay attention while backing up. Failure to do so can result in serious injury or death.

**CAUTION!**

- To avoid vehicle damage, ParkView should only be used as a parking aid. The ParkView camera is unable to view every obstacle or object in your drive path.
- To avoid vehicle damage, the vehicle must be driven slowly when using ParkView to be able to stop in time when an obstacle is seen. It is recommended that the driver look frequently over his/her shoulder when using ParkView.

**NOTE:**

If snow, ice, mud, or any foreign substance builds up on the camera lens, clean the lens, rinse with water, and dry with a soft cloth. Do not cover the lens.

**REFUELING THE VEHICLE**

The gas cap is located behind the fuel filler door on the left side of the vehicle. Use a finger to pull open the door. If the gas cap is lost or damaged, be sure to use the correct replacement cap for this vehicle.

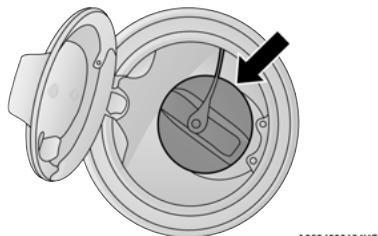
**Fuel Filler Cap****NOTE:**

When removing the fuel filler cap, lay the cap tether in the hook, located on the fuel filler door.

**WARNING!**

- Never have any smoking materials lit in or near the vehicle when the fuel door is open or the tank is being filled.

*(Continued)***WARNING!**

- Never add fuel when the engine is running. This is in violation of most state and federal fire regulations and may cause the Malfunction Indicator Light to turn on.
- A fire may result if fuel is pumped into a portable container that is inside of a vehicle. You could be burned. Always place fuel containers on the ground while filling.

**CAUTION!**

- Damage to the fuel system or emissions control system could result from using an improper fuel tank filler tube cap.
- A poorly fitting fuel filler cap could let impurities into the fuel system.
- A poorly fitting fuel filler cap may cause the Malfunction Indicator Light to turn on.
- To avoid fuel spillage and overfilling, do not "top off" the fuel tank after filling. When the fuel nozzle "clicks" or shuts off, the fuel tank is full.

**NOTE:**

- When the fuel nozzle “clicks” or shuts off, the fuel tank is full.
- Tighten the gas cap until you hear a “clicking” sound. This is an indication that the gas cap is tightened properly. The MIL in the instrument cluster may turn on if the gas cap is not secured properly. Make sure that the gas cap is tightened each time the vehicle is refueled.

**LOOSE FUEL FILLER CAP MESSAGE**

If the vehicle diagnostic system determines that the fuel filler cap is loose, improperly installed, or damaged, a “gASCAP” message will display in the odometer or a “Check Gascap” message will display in the instrument cluster. If this occurs, tighten the fuel filler cap properly and press the Trip Odometer button to turn off the message. If the problem continues, the message will appear the next time the vehicle is started.

A loose, improperly installed, or damaged fuel filler cap may also turn on the MIL.

**VEHICLE LOADING**

The load carrying capacity of your vehicle is shown on the “Vehicle Certification Label”. This information should be used for passenger and luggage loading as indicated.

Do not exceed the specified Gross Vehicle Weight Rating (GVWR) or the Gross Axle Weight Rating (GAWR).

**VEHICLE CERTIFICATION LABEL**

Your vehicle has a Vehicle Certification Label affixed to the drivers side B-pillar or the rear of the driver’s door.

The label contains the following information:

- Name of manufacturer
- Month and year of manufacture
- Gross Vehicle Weight Rating (GVWR)
- Gross Axle Weight Rating (GAWR) front
- Gross Axle Weight Rating (GAWR) rear
- Vehicle Identification Number (VIN)
- Type of vehicle
- Month, Day, and Hour of manufacture (MDH)

The bar code allows a computer scanner to read the VIN.

**GROSS VEHICLE WEIGHT RATING (GVWR)**

The GVWR is the total allowable weight of your vehicle. This includes driver, passengers, and cargo. The total load must be limited so that you do not exceed the GVWR.

**GROSS AXLE WEIGHT RATING (GAWR)**

The GAWR is the maximum capacity of the front and rear axles. Distribute the load over the front and rear axles evenly. Make sure that you do not exceed either front or rear GAWR.

**WARNING!**

Because the front wheels steer the vehicle, it is important that you do not exceed the maximum front or rear GAWR. A dangerous driving condition can result if either rating is exceeded. You could lose control of the vehicle and have a collision.

4

**OVERLOADING**

The load carrying components (axle, springs, tires, wheels, etc.) of your vehicle will provide satisfactory service as long as you do not exceed the GVWR and the front and rear GAWR.

The best way to figure out the total weight of your vehicle is to weigh it when it is fully loaded and ready for operation. Weigh it on a commercial scale to ensure that it is not over the GVWR.

Figure out the weight on the front and rear of the vehicle separately. It is important that you distribute the load evenly over the front and rear axles.

Overloading can cause potential safety hazards and shorten useful service life. Heavier axles or suspension components do not necessarily increase the vehicle's GVWR.

## LOADING

To load your vehicle properly, first figure out its empty weight, axle-by-axle and side-by-side. Store heavier items down low and be sure you distribute their weight as evenly as possible. Stow all loose items securely before driving. If weighing the loaded vehicle shows that you have exceeded either GAWR, but the total load is within the specified GVWR, you must redistribute the weight. Improper weight distribution can have an adverse effect on the way your vehicle steers and handles and the way the brakes operate.

### NOTE:

Refer to the Vehicle Certification Label affixed to the rear of the driver's door for your vehicle's GVWR and GAWRs → page 109.

## TRAILER TOWING

In this section, you will find safety tips and information on limits to the type of towing you can reasonably do with your vehicle. Before towing a trailer, carefully review this information to tow your load as efficiently and safely as possible.

To maintain warranty coverage, follow the requirements and recommendations in this manual concerning vehicles used for trailer towing.

### Manual Transmission — If Equipped

Trailer towing with this vehicle is not recommended.

## COMMON TOWING DEFINITIONS

The following trailer towing related definitions will assist you in understanding the following information:

### Gross Vehicle Weight Rating (GVWR)

The GVWR is the total allowable weight of your vehicle. This includes driver, passengers, cargo and tongue weight. The total load must be limited so that you do not exceed the GVWR → page 109.

### Gross Trailer Weight (GTW)

The GTW is the weight of the trailer plus the weight of all cargo, consumables, and equipment (permanent or temporary) loaded in or on the trailer in its "loaded and ready for operation" condition.

The recommended way to measure GTW is to put your fully loaded trailer on a vehicle scale. The entire weight of the trailer must be supported by the scale.

### Gross Combination Weight Rating (GCWR)

The GCWR is the total allowable weight of your vehicle and trailer when weighed in combination.

### Gross Axle Weight Rating (GAWR)

The GAWR is the maximum capacity of the front and rear axles. Distribute the load over the front and rear axles evenly. Make sure that you do not exceed either front or rear GAWR → page 109.

### WARNING!

It is important that you do not exceed the maximum front or rear GAWR. A dangerous driving condition can result if either rating is exceeded. You could lose control of the vehicle and have a collision.

## Tongue Weight (TW)

The TW is the downward force exerted on the hitch ball by the trailer. You must consider this as part of the load on your vehicle.

## Trailer Frontal Area

The frontal area is the maximum height multiplied by the maximum width of the front of a trailer.

## Trailer Sway Control (TSC)

The TSC can be a mechanical telescoping link that can be installed between the hitch receiver and the trailer tongue that typically provides adjustable friction associated with the telescoping motion to dampen any unwanted trailer swaying motions while traveling.

If equipped, the electronic TSC recognizes a swaying trailer and automatically applies individual wheel brakes and/or reduces engine power to attempt to eliminate the trailer sway.

## Weight-Carrying Hitch

A weight-carrying hitch supports the trailer tongue weight, just as if it were luggage located at a hitch ball or some other connecting point of the vehicle. These kinds of hitches are commonly used to tow small and medium sized trailers.

## Weight-Distributing Hitch

A weight-distributing system works by applying leverage through spring (load) bars. They are typically used for heavier loads to distribute trailer tongue weight to the tow vehicle's front axle and the trailer axle(s). When used in accordance with the manufacturer's directions, it provides for a more level ride, offering more consistent steering and brake control thereby enhancing towing safety. The addition of a friction/hydraulic sway control also dampens sway caused by traffic and crosswinds and contributes positively to tow vehicle and trailer stability. Trailer sway control and a weight distributing (load equalizing) hitch are

recommended for heavier Tongue Weights (TW) and may be required depending on vehicle and trailer configuration/loading to comply with Gross Axle Weight Rating (GAWR) requirements.

### WARNING!

- An improperly adjusted Weight Distributing Hitch system may reduce handling, stability, braking performance, and could result in a collision.
- Weight Distributing Systems may not be compatible with Surge Brake Couplers. Consult with your hitch and trailer manufacturer or a reputable Recreational Vehicle dealer for additional information.

## TRAILER HITCH CLASSIFICATION

The following chart provides the industry standard for the maximum trailer weight a given trailer hitch class can tow and should be used to assist you in selecting the correct trailer hitch for your intended towing condition.

Trailer Hitch Classification Definitions	
Class	Max. Trailer Hitch Industry Standards
Class I - Light Duty	2,000 lbs (907 kg)
Class II - Medium Duty	3,500 lbs (1,587 kg)
Class III - Heavy Duty	6,000 lbs (2,722 kg)
Class IV - Extra Heavy Duty	10,000 lbs (4,535 kg)

Refer to the "Trailer Towing Weights (Maximum Trailer Weight Ratings)" chart for the Maximum Gross Trailer Weight (GTW) towable for your given drivetrain.

All trailer hitches should be professionally installed on your vehicle.

## TRAILER TOWING WEIGHTS (MAXIMUM TRAILER WEIGHT RATINGS)

Engine/Transmission	Frontal Area	Maximum GTW	Maximum TW
3.6L Automatic	12 sq ft (1.11 sq m)	1,000 lb (454 kg)	100 lb (45 kg)
5.7L Automatic	12 sq ft (1.11 sq m)	1,000 lb (454 kg)	100 lb (45 kg)

Refer to local laws for maximum trailer towing speeds.

Trailer towing with the 5.7L manual transmission, 6.4L and 6.2L Supercharged engine is not recommended.

## TRAILER AND TONGUE WEIGHT

Never exceed the maximum tongue weight stamped on your fascia/bumper or trailer hitch.

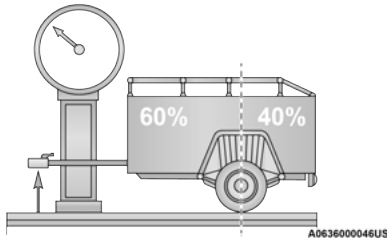

Weight Distribution

### CAUTION!

Always load a trailer with 60% of the weight in the front of the trailer. This places 10% of the GTW on the tow hitch of your vehicle. Loads balanced over the wheels or heavier in the rear can cause the trailer to sway severely side to side which will cause loss of control of the vehicle and trailer. Failure to load trailers heavier in front is the cause of many trailer collisions.

Consider the following items when computing the weight on the rear axle of the vehicle:

- The tongue weight of the trailer.
- The weight of any other type of cargo or equipment put in or on your vehicle.
- The weight of the driver and all passengers.

### NOTE:

Remember that everything put into or on the trailer adds to the load on your vehicle. Also, additional factory-installed options or dealer-installed options must be considered as part of the total load on your vehicle. Refer to the "Tire And Loading Information" placard for the maximum combined weight of occupants and cargo for your vehicle.

## TOWING REQUIREMENTS

To promote proper break-in of your new vehicle drivetrain components, the following guidelines are recommended.

### WARNING!

- Make certain that the load is secured in the trailer and will not shift during travel. When trailering cargo that is not fully secured, dynamic load shifts can occur that may be difficult for the driver to control. You could lose control of your vehicle and have a collision.

(Continued)

### WARNING!

- When hauling cargo or towing a trailer, do not overload your vehicle or trailer. Overloading can cause a loss of control, poor performance or damage to brakes, axle, engine, transmission, steering, suspension, chassis structure or tires.
- Safety chains must always be used between your vehicle and trailer. Always connect the chains to the hook retainers of the vehicle hitch. Cross the chains under the trailer tongue and allow enough slack for turning corners.
- Vehicles with trailers should not be parked on a grade. When parking, apply the parking brake on the tow vehicle. Put the tow vehicle transmission in PARK. Always, block or "chock" the trailer wheels.
- GCWR must not be exceeded.

(Continued)

**WARNING!**

- **Total weight must be distributed between the tow vehicle and the trailer such that the following four ratings are not exceeded:**
  - Max loading as defined on the “Tire and Loading Information” placard.
  - GTW
  - GAWR
  - Tongue weight rating for the trailer hitch utilized.

Perform the maintenance listed in the “Scheduled Servicing” ⇨ page 251. When towing a trailer, never exceed the GAWR or GCWR ratings.

**CAUTION!**

- Do not tow a trailer at all during the first 500 miles (805 km) the new vehicle is driven. The engine, axle or other parts could be damaged.
- Then, during the first 500 miles (805 km) that a trailer is towed, do not drive over 50 mph (80 km/h) and do not make starts at full throttle. This helps the engine and other parts of the vehicle wear in at the heavier loads.

**Towing Requirements — Tires**

- Do not attempt to tow a trailer while using a compact spare tire.
- Do not drive more than 50 mph (80 km/h) when towing while using a full size spare tire.
- Proper tire inflation pressures are essential to the safe and satisfactory operation of your vehicle. For proper tire inflation procedures.
- Check the trailer tires for proper tire inflation pressures before trailer usage.
- Check for signs of tire wear or visible tire damage before towing a trailer.
- Replacing tires with a higher load carrying capacity will not increase the vehicle's GVWR and GAWR limits.
- For further information ⇨ page 285.

**Towing Requirements — Trailer Brakes**

- Do **not** interconnect the hydraulic brake system or vacuum system of your vehicle with that of the trailer. This could cause inadequate braking and possible personal injury.
- An electronically actuated trailer brake controller is required when towing a trailer with electronically actuated brakes. When towing a

trailer equipped with a hydraulic surge actuated brake system, an electronic brake controller is not required.

- Trailer brakes are recommended for trailers over 1,000 lb (453 kg) and required for trailers in excess of 2,000 lb (907 kg).

**WARNING!**

- Do not connect trailer brakes to your vehicle's hydraulic brake lines. It can overload your brake system and cause it to fail. You might not have brakes when you need them and could have an accident.
- Towing any trailer will increase your stopping distance. When towing, you should allow for additional space between your vehicle and the vehicle in front of you. Failure to do so could result in an accident.

**CAUTION!**

If the trailer weighs more than 1,000 lb (453 kg) loaded, it should have its own brakes and they should be of adequate capacity. Failure to do this could lead to accelerated brake lining wear, higher brake pedal effort, and longer stopping distances.



## Towing Requirements – Trailer Lights And Wiring

Whenever you pull a trailer, regardless of the trailer size, stoplights and turn signals on the trailer are required for motoring safety.

The Trailer Tow Package may include a four- and seven-pin wiring harness. Use a factory approved trailer harness and connector.

### NOTE:

Do not cut or splice wiring into the vehicle's wiring harness.

The electrical connections are all complete to the vehicle but you must mate the harness to a trailer connector. Refer to the following illustrations.

### NOTE:

- Disconnect the trailer wiring connector from the vehicle (or any other device plugged into the vehicle's electrical connectors) before launching a boat into water.
- Be sure to reconnect after clear from water area.

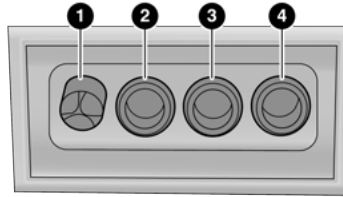

M0636000043US

#### Four-Pin Connector

- 1 – Ground
- 2 – Park
- 3 – Left Stop/Turn
- 4 – Right Stop/Turn

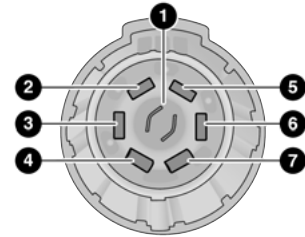

A0636000085US

#### Seven-Pin Connector

- 1 – Backup Lamps
- 2 – Running Lamps
- 3 – Left Stop/Turn
- 4 – Ground
- 5 – Battery
- 6 – Right Stop/Turn
- 7 – Electric Brakes

## TOWING TIPS

Before towing, practice turning, stopping, and backing up the trailer in an area located away from heavy traffic.

### Automatic Transmission — If Equipped

Select the DRIVE range when towing. The transmission controls include a drive strategy to avoid frequent shifting when towing. However, if frequent shifting does occur while in DRIVE, you can use the AutoStick shift control to manually select a lower gear.

#### NOTE:

Using a lower gear while operating the vehicle under heavy loading conditions will improve performance and extend transmission life by reducing excessive shifting and heat build-up. This action will also provide better engine braking.

### Cruise Control — If Equipped

- Do not use on hilly terrain or with heavy loads.
- When using the Cruise Control, if you experience speed drops greater than 10 mph (16 km/h), disengage until you can get back to cruising speed.
- Use Cruise Control in flat terrain and with light loads to maximize fuel efficiency.

### AutoStick

- When using the AutoStick shift control, select the highest gear that allows for adequate performance and avoids frequent downshifts. For example, choose “5” if the desired speed can be maintained. Choose “4” or “3” if needed to maintain the desired speed.
- To prevent excess heat generation, avoid continuous driving at high RPM. Reduce vehicle speed as necessary to avoid extended driving at high RPM. Return to a higher gear or vehicle speed when grade and road conditions allow.

## RECREATIONAL TOWING (BEHIND MOTORHOME)

Recreational towing (with all four wheels on the ground, or using a tow dolly) is **NOT ALLOWED**. The only acceptable method for towing this vehicle (behind another vehicle) is on a vehicle trailer with all four wheels **OFF** the ground.

CAUTION!
Towing this vehicle in violation of the above requirements can cause severe engine, transmission and/or transfer case damage. Damage from improper towing is not covered under the New Vehicle Limited Warranty.

## DRIVING TIPS

### DRIVING ON SLIPPERY SURFACES

Information in this section will aid in safe controlled launches in adverse conditions.

#### Acceleration

Rapid acceleration on snow covered, wet, or other slippery surfaces may cause the driving wheels to pull erratically to the right or left. This phenomenon occurs when there is a difference in the surface traction under the rear (driving) wheels.

#### WARNING!

Rapid acceleration on slippery surfaces is dangerous. Unequal traction can cause sudden pulling of the rear wheels. You could lose control of the vehicle and possibly have a collision. Accelerate slowly and carefully whenever there is likely to be poor traction (ice, snow, wet, mud, loose sand, etc.).

#### Traction

When driving on wet or slushy roads, it is possible for a wedge of water to build up between the tire and road surface. This is known as hydroplaning and may cause partial or complete loss of vehicle control and stopping ability. To reduce this possibility, the following precautions should be observed:

- Slow down during rainstorms or when the roads are slushy.
- Slow down if the road has standing water or puddles.
- Replace tires when tread wear indicators first become visible.
- Keep tires properly inflated.
- Maintain sufficient distance between your vehicle and the vehicle in front of you to avoid a collision in a sudden stop.

Your vehicle may be equipped with a Limited Slip Differential (LSD) that reduces, but does not eliminate, the amount of wheel slip across a given axle for improved handling.

### DRIVING THROUGH WATER

Driving through water more than a few inches/centimeters deep will require extra caution to ensure safety and prevent damage to your vehicle.

#### Flowing/Rising Water

#### WARNING!

Do not drive on or across a road or path where water is flowing and/or rising (as in storm run-off). Flowing water can wear away the road or path's surface and cause your vehicle to sink into deeper water. Furthermore, flowing and/or rising water can carry your vehicle away swiftly. Failure to follow this warning may result in injuries that are serious or fatal to you, your passengers, and others around you.

## Shallow Standing Water

Although your vehicle is capable of driving through shallow standing water, consider the following Warnings and Cautions before doing so.

### WARNING!

- Driving through standing water limits your vehicle's traction capabilities. Do not exceed 5 mph (8 km/h) when driving through standing water.
- Driving through standing water limits your vehicle's braking capabilities, which increases stopping distances. Therefore, after driving through standing water, drive slowly and lightly press on the brake pedal several times to dry the brakes.
- Failure to follow these warnings may result in injuries that are serious or fatal to you, your passengers, and others around you.

### CAUTION!

- Always check the depth of the standing water before driving through it. Never drive through standing water that is deeper than the bottom of the tire rims mounted on the vehicle.
- Determine the condition of the road or the path that is under water and if there are any obstacles in the way before driving through the standing water.
- Do not exceed 5 mph (8 km/h) when driving through standing water. This will minimize wave effects.

*(Continued)*

### CAUTION!

- Driving through standing water may cause damage to your vehicle's drivetrain components. Always inspect your vehicle's fluids (i.e., engine oil, transmission, axle, etc.) for signs of contamination (i.e., fluid that is milky or foamy in appearance) after driving through standing water. Do not continue to operate the vehicle if any fluid appears contaminated, as this may result in further damage. Such damage is not covered by the New Vehicle Limited Warranty.
- Getting water inside your vehicle's engine can cause it to lock up and stall out, and cause serious internal damage to the engine. Such damage is not covered by the New Vehicle Limited Warranty.

# MULTIMEDIA

## UCONNECT SYSTEMS

For detailed information about your Uconnect 4C/4C NAV With 8.4-inch Display system, refer to your Uconnect Owner's Manual Supplement.

### NOTE:

Uconnect screen images are for illustration purposes only and may not reflect exact software for your vehicle.

## CYBERSECURITY

Your vehicle may be a connected vehicle and may be equipped with both wired and wireless networks. These networks allow your vehicle to send and receive information. This information allows systems and features in your vehicle to function properly.

Your vehicle may be equipped with certain security features to reduce the risk of unauthorized and unlawful access to vehicle systems and wireless communications. Vehicle software technology continues to evolve over time and FCA US LLC, working with its suppliers, evaluates and takes appropriate steps as needed. Similar to a computer or other devices, your vehicle may require software updates to improve the usability and performance of your systems or to reduce the potential risk of unauthorized and unlawful access to your vehicle systems.

The risk of unauthorized and unlawful access to your vehicle systems may still exist, even if the most recent version of vehicle software (such as Uconnect software) is installed.

### WARNING!

- It is not possible to know or to predict all of the possible outcomes if your vehicle's systems are breached. It may be possible that vehicle systems, including safety related systems, could be impaired or a loss of vehicle control could occur that may result in an accident involving serious injury or death.

*(Continued)*

### WARNING!

- ONLY insert media (e.g., USB or CD) into your vehicle if it came from a trusted source. Media of unknown origin could possibly contain malicious software, and if installed in your vehicle, it may increase the possibility for vehicle systems to be breached.
- As always, if you experience unusual vehicle behavior, take your vehicle to your nearest authorized dealer immediately.

### NOTE:

- FCA US LLC or an authorized dealer may contact you directly regarding software updates.
- To help further improve vehicle security and minimize the potential risk of a security breach, vehicle owners should:
  - Routinely check [www.driveuconnect.com](http://www.driveuconnect.com) (US Residents) or [www.driveuconnect.ca](http://www.driveuconnect.ca) (Canadian Residents) to learn about available Uconnect software updates.
  - Only connect and use trusted media devices (e.g. personal mobile phones, USBs, CDs).

Privacy of any wireless and wired communications cannot be assured. Third parties may unlawfully intercept information and private communications without your consent. For further information, refer to “Data Collection & Privacy” in your Uconnect Owner’s Manual Supplement or “Onboard Diagnostic System (OBD II) Cybersecurity” ↗ page 76.

## UCONNECT SETTINGS

The Uconnect system uses a combination of buttons on the touchscreen and buttons on the faceplate located on the center of the instrument panel. These buttons allow you to access and change the Customer Programmable Features. Many features can vary by vehicle.

Buttons on the faceplate are located below and/or beside the Uconnect system in the center of the instrument panel. In addition, there is a SCROLL/ENTER control knob located on the right side. Turn the control knob to scroll through menus and change settings. Push the center of the control knob one or more times to select or change a setting.

Your Uconnect system may also have SCREEN OFF and MUTE buttons on the faceplate.

Push the SCREEN OFF button on the faceplate to turn off the Uconnect screen. Push the button again or tap the screen to turn the screen on.

Press the Back Arrow button to exit out of a Menu or certain option on the Uconnect system.

## CUSTOMER PROGRAMMABLE FEATURES

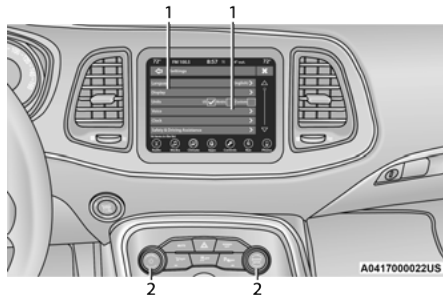

### Uconnect 4C/4C NAV With 8.4-inch Display Buttons On The Faceplate And Buttons On The Touchscreen

- 1 — Uconnect Buttons On The Touchscreen
- 2 — Uconnect Buttons On The Faceplate

### For the Uconnect 4 With 7-inch Display and the Uconnect 4C/4C NAV With 8.4-inch Display

Press the **U** Apps button, then press the Settings button on the touchscreen to display the menu setting screen. In this mode, the Uconnect system allows you to access programmable features.

#### NOTE:

- All settings should be changed with the ignition in the ON/RUN position.
- Only one area of the touchscreen may be selected at a time.

When making a selection, press one button on the touchscreen to enter the desired menu. Once in the desired mode, press and release the preferred setting option until a check mark appears next to the setting, showing that setting has been selected. Once the setting is complete, either press the Back Arrow button on the touchscreen to return to the previous menu, or press the X button on the touchscreen to close out of the settings screen. Pressing the Up or Down Arrow button on the right side of the screen will allow you to toggle up or down through the available settings.

#### NOTE:

Availability of settings, setting names, and menu options can vary depending on vehicle features, equipped Uconnect system, and the currently installed software.

## Language

When the Language button is pressed on the touchscreen, the system displays the different language options. Once an option is selected, the system will display in the chosen language.

### NOTE:

Depending on the vehicle's options, feature settings may vary.

Setting Name	Description
Language	This setting will change the language of the Uconnect system. The available languages are English, Français, and Español.

## Display

When the Display button is pressed on the touchscreen, the system will display the options related to the theme, brightness, and color of the touchscreen. The available settings are:

### NOTE:

Depending on the vehicle's options, feature settings may vary.

Setting Name	Description
Display Mode	This setting will allow you to set the brightness manually or have the system set it automatically. The "Auto" setting has the system automatically adjust the display brightness. The "Manual" setting will allow the user to adjust the brightness of the display.
Display Brightness With Headlights ON	This setting will allow you to set the brightness when the headlights are on. To access this setting, Display Mode must be set to Manual. The "+" setting will increase the brightness; the "-" will decrease the brightness.

Setting Name	Description
Display Brightness With Headlights OFF	This setting will allow you to set the brightness when the headlights are off. To access this setting, Display Mode must be set to Manual. The "+" setting will increase the brightness; the "-" will decrease the brightness.
Set Theme	This setting will allow you to change the display theme.
Touchscreen Beep	This setting will allow you to turn the touchscreen beep on or off.
Control Screen Timeout	This setting will allow you to set the Control Screen to turn off automatically after five seconds or stay open until manually closed.
Navigation Next Turn Pop-ups Displayed in Cluster	This setting will display navigation prompts in the Instrument Cluster Display.

## Units

When the Units button is pressed on the touchscreen, the system displays the different measurement options. The selected unit of measurement will display in the instrument cluster display and Navigation system (if equipped). The available settings are:

### NOTE:

Depending on the vehicle's options, feature settings may vary.

Setting Name	Description
US	This setting will change the unit of measurement on the display to US.
Metric	This setting will change the unit of measurement on the display to Metric.
Custom	This setting changes the "Speed" (MPH or km/h), "Distance" (mi or km), "Fuel Consumption" (MPG [US], MPG [UK], L/100 km, or km/L), "Pressure" (psi, kPa, or bar), and "Temperature" (°C or °F) units of measurement independently.



## Voice

When the Voice button is pressed on the touchscreen, the system displays the options related to the vehicle's Voice Recognition feature.

### NOTE:

Depending on the vehicle's options, feature settings may vary.

Setting Name	Description
Voice Response Length	This setting will change the response length for the Voice Recognition system. The "Brief" setting provides a shortened audio description from the system. The "Detailed" setting provides the full audio description from the system.
Show Command List	This setting will allow you to turn the Command List on or off. The "Always" setting will always show the Command List. The "With Help" setting will show the Command List and provide a brief description of what the command does. The "Never" setting will turn the Command List off.

5

## Clock

When the Clock button is pressed on the touchscreen, the system displays the different options related to the vehicle's internal clock.

### NOTE:

Depending on the vehicle's options, feature settings may vary.

Setting Name	Description
Sync Time With GPS	This setting will sync the time to the GPS receiver in the system. The system will control the time via the GPS location.

Setting Name	Description
Time Format	This setting will allow you set the time format (AM/PM). Sync Time With GPS must be off for this setting to be available. The "12 hrs" setting will set the time to a 12-hour format. The "24 hrs" setting will set the time to a 24-hour format.
Set Time Hours	This setting will allow you to set the hours. Sync Time With GPS must be off for this setting to be available. The "+" setting will increase the hours. The "-" setting will decrease the hours.
Set Time Minutes	This setting will allow you to set the minutes. Sync Time With GPS must be off for this setting to be available. The "+" setting will increase the minutes. The "-" setting will decrease the minutes.
Show Time in Status Bar	This setting will place the time in the radio's status bar.

## Camera

When the Camera button is pressed on the touchscreen, the system displays the options related to the vehicle's camera features. Depending on the radio equipped in the vehicle, the Camera settings may be located in the Safety/Assistance settings.

### NOTE:

Depending on the vehicle's options, feature settings may vary.

Setting Name	Description
ParkView Backup Camera Delay	This setting will add a delay to the ParkView Backup Camera when shifting out of REVERSE.
Active ParkView Backup Camera Guidelines	This setting will turn the Active ParkView Backup Camera Guidelines on or off.

## Safety/Assistance

When the Safety/Assistance button is selected on the touchscreen, the system displays the options related to the vehicle's safety settings. These options will differ depending on the features equipped on the vehicle. The settings may display in list form or within subfolders on the screen. To access a subfolder, select the desired folder; the available options related to that feature will then display on the screen.

### NOTE:

Depending on the vehicle's options, feature settings may vary.

Setting Name	Description
Forward Collision Warning Sensitivity	This setting will change the distance at which the Forward Collision Warning (FCW) alert sounds. The "Medium" setting will have the FCW system signal when an object is in view, and the possibility of a collision is detected. The "Near" setting will have the FCW system signal when the object is closer to the vehicle. The "Far" setting will have the FCW system signal when an object is at a far distance from the vehicle.
Forward Collision Warning	This setting will turn the Forward Collision Warning system on or off. The "Off" setting will deactivate the FCW system. The "Warning Only" setting will provide only an audible chime when a collision is detected. The "Warning + Active Braking" setting will provide an audible chime and apply brake pressure when a collision is detected.
ParkSense	This setting will change the type of ParkSense alert when a close object is detected and provide both an audible chime and a visual display.
Rear ParkSense Volume	This setting adjusts the volume of the Rear ParkSense system. The available settings are "Low", "Medium", and "High".

Setting Name	Description
Blind Spot Alert	This setting will change the type of alert provided when an object is detected in a vehicle's blind spot. The "Off" setting will turn off Blind Spot Alert. The "Lights" setting will activate the Blind Spot Alert lights on the outside mirrors. The "Lights & Chime" setting will activate both the lights on the outside mirrors and an audible chime.
Electric Power Steering	This setting will adjust the electric power steering modes. Setting options are "Normal", "Sport", and "Comfort".
Hill Start Assist	This setting will turn the Hill Start Assist system on or off.
ParkView Backup Camera Active Guidelines	This setting will turn the ParkView Backup Camera Active Guidelines on or off.
ParkView Backup Camera Delay — If Equipped	This setting will add a delay to the ParkView Backup Camera when shifting out of REVERSE.
Rain Sensing Auto Wipers	This setting will turn the Rain Sensing Auto Wipers on or off.
Tilt Mirrors In Reverse	This setting will tilt the mirrors when the vehicle is placed in REVERSE.

### Mirrors & Wipers — If Equipped

When the Mirrors & Wipers button is pressed on the touchscreen, the system displays the options related to the vehicle's mirrors and wipers.

**NOTE:**

Depending on the vehicle's options, feature settings may vary.

Setting Name	Description
Tilt Side Mirrors in Reverse	This Setting will tilt the mirrors when the vehicle is placed in REVERSE. Setting options are "On" and "Off".
Rain Sensing Auto Wipers	This setting will turn the Rain Sensing Auto Wipers on or off.

Setting Name	Description
Headlights with Wipers	This setting will turn the headlights on when the wipers are activated. Setting options are “On” and “Off”.

## Lights

When the Lights button is pressed on the touchscreen, the system displays the options related to the vehicle’s exterior and interior lights.

### NOTE:

- When the “Daytime Running Lights” feature is selected, the daytime running lights can be turned On or Off. This feature is only allowed by law in the country of the vehicle purchased.
- Depending on the vehicle’s options, feature settings may vary.

Setting Name	Description
Headlight Off Delay	This setting will allow you to set the amount of time it takes for the headlights to shut off after the vehicle is turned off. The available settings are “0 sec”, “30 sec”, “60 sec”, and “90 sec”.
Headlight Illumination On Approach	This setting will allow you to set the amount of time it takes for the headlights to shut off after the vehicle is unlocked. The available settings are “0 sec”, “30 sec”, “60 sec”, and “90 sec”.
Headlights with Wipers	This setting will turn the headlights on when the wipers are activated.
Daytime Running Lights	This setting will allow you to turn the Daytime Running Lights on or off.
Flash Lights With Lock	This setting will allow you to turn on or off the flashing of the lights when the Lock button is pushed on the key fob. Available settings are “On” and “Off”.
Auto Dim High Beams	This setting will allow you to turn the Auto Dim High Beams on or off.

## Doors & Locks

When the Doors & Locks button is pressed on the touchscreen, the system displays the options related to locking and unlocking the vehicle's doors.

**NOTE:**

Depending on the vehicle's options, feature settings may vary.

Setting Name	Description
Auto Unlock On Exit	This setting will unlock the doors when any of the doors are opened from the inside.
Flash Lights With Lock	This setting will allow you to turn on or off the flashing of the lights when the Lock button is pushed on the key fob. Available settings are "On" and "Off".
Sound Horn With Lock	This setting will sound the horn when the Lock button is pushed on the key fob. The "Off" setting will not sound the horn when the Lock button is pushed. The "1st Press" setting will sound the horn when the Lock button is pushed once. The "2nd Press" setting will sound the horn when the Lock button is pushed twice.
Sound Horn With Remote Start	This setting will sound the horn when the remote start is activated from the key fob.
Remote Door Unlock	This setting will change how many pushes of the Unlock button on the key fob are needed to unlock all the doors. The "Driver Door" setting will only unlock the driver door on the first push on the Unlock button. The "All Doors" setting will unlock all doors on the first push of the Unlock button.

Setting Name	Description
Passive Entry	This setting will allow you to turn the Passive Entry feature (Keyless Enter 'n Go™) on or off.
Personal Settings Linked To Key Fob	This setting will recall preset radio stations and driver seat position that have been linked to the key fob.

## Seats & Comfort

When Seats & Comfort button is pressed on the touchscreen, the system displays the option related to the vehicle's comfort systems when remote start has been activated or the vehicle has been started.

### NOTE:

Depending on the vehicle's options, feature settings may vary.

Setting Name	Description
Auto-On Driver Heated/Ventilated Seat & Steering Wheel With Vehicle Start	This setting will activate the vehicle's comfort system and heated seats or heated steering wheel when the vehicle is remote started or ignition is started. The "Off" setting will not activate the comfort systems. The "Remote Start" setting will only activate the comfort systems when using Remote Start. The "All Start" setting will activate the comfort systems whenever the vehicle is started.

## Key Off/Engine Off Options

When the Key Off/Engine Off Options button is pressed on the touchscreen, the system displays the options related to vehicle shut off. These settings will only activate when the ignition is set to OFF.

### NOTE:

Depending on the vehicle's options, feature settings may vary.

Setting Name	Description
Easy Exit Seat	This setting adjusts the seats to make exiting the vehicle easier.
Key Off/Engine Off Power Delay	This setting will keep certain electrical features running after the engine is turned off. When any door is opened, the electronics will deactivate. The available settings are "0 sec", "45 sec", "5 min", and "10 min".
Headlight Off Delay	This setting will allow you to set the amount of time the headlights remain on after the vehicle has been turned off. The "+" will increase the amount of time. The "-" will decrease the amount of time.

## Audio

When the Audio button is pressed on the touchscreen, the system displays options related to the vehicle's sound system. These settings can change the audio location within the vehicle, adjust the bass or treble levels, and auto-play settings from an audio device or smartphone.

### NOTE:

Depending on the vehicle's options, feature settings may vary.

Setting Name	Description
Balance/Fade	This setting will adjust audio levels from specific speakers in the front/back and left/right of the vehicle. The Speaker icon can be moved to set audio location.



Setting Name	Description
Equalizer	This setting will adjust the “Bass”, “Mid”, and “Treble” ranges of the audio.
Speed Adjusted Volume	This setting will adjust audio volume as speeds increase. At a higher setting, the volume will increase more as the vehicle speeds up. The available settings are “Off”, “1”, “2”, and “3”.
Surround Sound	This setting will turn the Surround Sound system on or off.
AUX Volume Offset	This setting will tune the audio levels from a device connected through the AUX port. The available settings are “+” and “-”.
Auto Play	This setting will automatically begin playing audio from a connected device.

## Phone/Bluetooth®

When the Phone/Bluetooth® button is pressed on the touchscreen, the system displays the options related to Bluetooth® connectivity from an external audio device or smartphone. The list of paired audio devices or smartphones can be accessed from this menu.

### NOTE:

Depending on the vehicle’s options, feature settings may vary.

Setting Name	Description
Phone Pop-Ups Displayed In Cluster	This setting will activate phone message pop-ups in the Instrument Cluster Display.
Do Not Disturb	This setting will open the Do Not Disturb settings menu. The following settings are “Auto Reply” (both, text, call), “Auto Reply Message” (custom, default), and “Custom Auto Reply Message” (create message).
Paired Phones And Audio Devices	This setting will show the list of paired phones and audio devices.

## SiriusXM® Setup – If Equipped

When the SiriusXM® Setup button is pressed on the touchscreen, the system displays options related to SiriusXM® Satellite Radio. These settings can be used to skip specific radio channels and restart favorite songs from the beginning.

### NOTE:

- A subscription to SiriusXM® Satellite Radio is required for these settings to be functional.
- Depending on the vehicle's options, feature settings may vary.

Setting Name	Description
Tune Start	This setting will play the current song from the beginning when you tune to a music channel using one of the 12 presets.
Channel Skip	This setting allows you to set channels that you wish to skip. A channel list will display of the skipped channels.
Subscription Information	This menu provides SiriusXM® subscription information. SiriusXM® Travel Link is a separate subscription.

## Restore Settings

When the Restore Settings button is pressed on the touchscreen, the system displays the options related to resetting the Uconnect system back to its default settings. These settings can clear personal data and reset selected settings from other menus.

### NOTE:

Depending on the vehicle's options, feature settings may vary.

Setting Name	Description
Restore Settings	This setting will return all the previously changed settings to their factory default.

Setting Name	Description
Reset App Drawer	This setting will reset the app drawer to its factory default layout.
Clear Personal Data	This setting will display a pop-up that gives you the option to clear all personal data from the system, including Bluetooth® devices and presets.

### Clear Personal Data – If Equipped

When the Clear Personal Data button is pressed on the touchscreen, the system displays the radio system information.

**NOTE:**

Depending on the vehicle's options, feature settings may vary.

Setting Name	Description
Clear Personal Data	This setting will clear the personal data on the radio.

5

### System Information – If Equipped

When the System Information button is pressed on the touchscreen, the system displays the radio system information.

**NOTE:**

Depending on the vehicle's options, feature settings may vary.

Setting Name	Description
Software Licenses	This will display the software licensing information screen.

## UCONNECT INTRODUCTION

### SYSTEM OVERVIEW







Uconnect 4 With 7-inch Display

- 1 – Radio Button
- 2 – Media Button
- 3 – Climate Button
- 4 – Apps Button

- 5 – Controls Button
- 6 – Phone Button
- 7 – Settings Button

**NOTE:**

Uconnect screen images are for illustration purposes only and may not reflect exact software for your vehicle.

Feature	Description
<b>Radio/Media</b>	Press the Radio button or Media button to enter Radio Mode/Media Mode and access the radio functions and external audio sources ↪ page 137.
<b>Phone</b>	Press the Phone button to enter Phone Mode and access the hands-free phone system ↪ page 149.
<b>Settings</b>	Press the Settings button to access the Uconnect Settings ↪ page 120.
	Push the Enter/Browse button on the faceplate to accept a highlighted selection on the screen. Rotate the Tune/Scroll rotary knob to scroll through a list or tune a radio station.
	Push the Screen Off button on the faceplate to turn the screen on or off.
	Push the Mute button on the faceplate to turn the audio of the radio system off. Push it again to turn the audio back on.
	<p>Rotate the rotary knob to adjust the volume. Push the Volume &amp; On/Off button on the faceplate to turn the system on or off.</p> <p><b>NOTE:</b> Push and hold the Volume &amp; On/Off button for approximately 10 seconds to reset the radio manually. Doing this can also recover the radio screen from freezing or being stuck.</p>

Feature	Description
Controls – If Equipped	Push the Controls button to access vehicle-specific features like heated seats and steering wheel.
Apps	Press the Apps button to access a list of the available Uconnect apps.
Climate	Press the Climate button to enter Climate Mode and access the climate control functions → page 48.

## DRAG & DROP MENU BAR

The Uconnect features and services in the main menu bar are easily customized for your preference. Simply follow these steps:

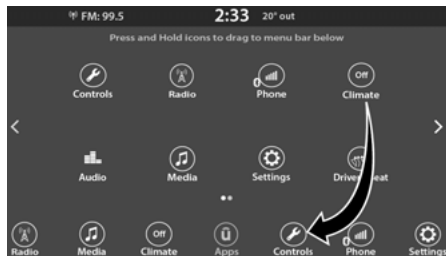

Uconnect 4 With 7-inch Display Drag & Drop

1. Press the Apps  button to open the App screen.
2. Press and hold, then drag the selected app to replace an existing shortcut in the main menu bar.

### NOTE:

This feature is only available if the vehicle is in PARK.

## SAFETY AND GENERAL INFORMATION

### Safety Guidelines

#### WARNING!

ALWAYS drive safely with your hands on the steering wheel. You have full responsibility and assume all risks related to the use of the Uconnect features and applications in this vehicle. Only use Uconnect when it is safe to do so. Failure to do so may result in an accident involving serious injury or death.

Please read this manual carefully before using the system. It contains instructions on how to use the system in a safe and effective manner.

**Do NOT attach any object to the touchscreen. Doing so can result in damage to the touchscreen.**

Please read and follow these safety precautions. Failure to do so may result in injury or property damage.

- Glance at the screen only when safe to do so. If prolonged viewing of the screen is required, park in a safe location and set the parking brake.
- Stop use immediately if a problem occurs. Failure to do so may cause injury or damage to the product. See an authorized dealer for repair.
- Ensure the volume level of the system is set to a level that still allows you to hear outside traffic and emergency vehicles.

## Safe Usage Of The Uconnect System

- The Uconnect system is a sophisticated electronic device. Do not let young children use the system.
- Permanent hearing loss may occur if you play your music or sound system at loud volumes. Exercise caution when setting the volume on the system.
- Keep drinks, rain and other sources of moisture away from the system. Besides damage to the system, moisture can cause electric shocks as with any electronic device.

### NOTE:

Many features of this system are speed dependent. For your own safety, it is not possible to use some of the touchscreen features while the vehicle is in motion.

## Care And Maintenance

- Do not press the touchscreen with any hard or sharp objects (pen, USB stick, jewelry, etc.), which could scratch the surface.
- Do not spray any liquid or chemicals directly on the screen! Use a clean and dry microfiber lens cleaning cloth in order to clean the touchscreen.

- If necessary, use a lint-free cloth dampened with a cleaning solution, such as isopropyl alcohol or an isopropyl alcohol and water solution ratio of 50:50. Be sure to follow the solvent manufacturer's precautions and directions → page 318.

## UCONNECT MODES

### STEERING WHEEL AUDIO CONTROLS

The remote sound system controls are located on the rear surface of the steering wheel at the three and nine o'clock positions.



Remote Sound System Controls

The right-hand control is a rocker-type switch with a push button in the center and controls the volume and mode of the sound system. Pushing the top of the rocker switch will increase the volume, and pushing the bottom of the rocker switch will decrease the volume.

Pushing the center button will make the radio switch between the various modes available (AM/FM/SXM or Media, etc.).

The left-hand control is a rocker-type switch with a push button in the center. The function of the left-hand control is different depending on which mode you are in.

The following describes the left-hand control operation in each mode:

### Radio Operation

Pushing the top of the switch will Seek Up for the next available station and pushing the bottom of the switch will Seek Down for the next available station.

The button located in the center of the left-hand control will tune to the next preset station that you have programmed in the radio presets.

## Media Mode

Pushing the top of the switch skips to the next track on the selected media (AUX/USB/Bluetooth®). Pushing the switch up twice will go forward two tracks. Pushing the bottom switch goes to the beginning of the current track, or the beginning of the previous track if it is within eight seconds after the current track begins to play. Double pressing the bottom button switch will skip to the previous track if it is after eight seconds into the current track.

## RADIO MODE

### Radio Controls

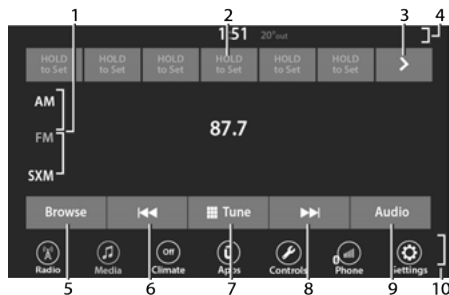

Uconnect 4 With 7-inch Display

- 1 – Radio Bands
- 2 – Preset Radio Stations
- 3 – View Next Preset Radio Stations
- 4 – Status Bar
- 5 – Browse Button
- 6 – Seek Down ◀◀
- 7 – Tune Button
- 8 – Seek Up ▶▶
- 9 – Audio Settings
- 10 – Bottom Bar

The radio is equipped with the following modes:

- AM
- FM
- SiriusXM® Satellite Radio (if equipped)

Press the Radio button on the touchscreen to enter the Radio Mode. The different tuner modes, AM, FM, and SXM, can then be selected by pressing the corresponding buttons in Radio Mode.

### Volume & On/Off Control

Push the Volume & On/Off control knob to turn on and off the Uconnect system.

The electronic volume control turns continuously (360 degrees) in either direction, without stopping. Turning the Volume & On/Off control knob clockwise increases the volume, and counterclockwise decreases it.

When the audio system is turned on, the sound will be set at the same volume level as last played.



### Mute Button

Push the Mute button to mute or unmute the system.

### Tune/Scroll Control

Turn the rotary Tune/Scroll control knob clockwise to increase or counterclockwise to decrease the radio station frequency. Push the Enter/Browse button to choose a selection.

### Seek

The Seek Up and Down functions are activated by pressing the double arrow buttons on the touchscreen to the right and left of the radio station display or by pushing the left steering wheel audio control button up or down.

### Seek Up ►► and Seek Down ◀◀

Press and release the Seek Up ►► or

Seek Down ◀◀ button to tune the radio to the next available station or channel. During a Seek Up/Down function, if the radio reaches the starting station after passing through the entire band two times, the radio will stop at the station where it began.

### Fast Seek Up ►► and Fast Seek Down ◀◀

Press and hold, and then release the

Seek Up ►► or Seek Down ◀◀ button to advance the radio through the available stations or channels at a faster rate. The radio stops at the next available station or channel when the button on the touchscreen is released.

### NOTE:

Pressing and holding either the Seek Up ►► or Seek Down ◀◀ button will scan the different frequency bands at a slower rate.

### Direct Tune

Press the Tune button located at the bottom of the radio screen to directly tune to a desired radio station or channel.

Press the available number button on the touchscreen to begin selecting a desired station. Once a number has been entered, any numbers that are no longer possible (stations that cannot be reached) will become deactivated/grayed out.

### Undo

You can backspace an entry by pressing the Back  button on the touchscreen.

### GO

Once the last digit of a station has been entered, press “Ok”. The Direct Tune screen will close, and the system will automatically tune to that station.

### RADIO VOICE COMMANDS

Use your voice to quickly get to the AM, FM, or SiriusXM® Satellite Radio stations you would like to hear. (Subscription or included SiriusXM® Satellite Radio trial required.)

Push the VR button  on the steering wheel and wait for the beep to say a command. See an example:

- “Tune to ninety-five-point-five FM”
- “Tune to Satellite Channel Hits 1”

**Did You Know:** At any time, if you are not sure of what to say or want to learn a Voice Command, push the VR button  and say “Help”. The system provides you with a list of commands.

## SiriusXM® Satellite Radio Mode — If Equipped



### Uconnect 4 With 7-inch Display Changing To SiriusXM®

#### NOTE:

Some SiriusXM® features are not supported by all SiriusXM® channels or content, for example song and artist favorites, sport game notifications, tune start, and others.

SiriusXM® Satellite Radio uses direct satellite-to-receiver broadcasting technology to provide clear, coast-to-coast radio content. SiriusXM® is a subscription-based service.

Visit <https://www.siriusxm.com/phx/getlogin> or review your SiriusXM® Radio pamphlet in your Owner's Manual kit for more information.

SiriusXM® services require subscriptions, sold separately after the trial included with the new vehicle purchase. If you decide to continue your service at the end of your trial subscription, the plan you choose will automatically renew and bill at then-current rates until you call SiriusXM® at 866-635-2349 to cancel. See SiriusXM® Customer Agreement for complete terms at [www.siriusxm.com](http://www.siriusxm.com) (US) or [www.siriusxm.ca](http://www.siriusxm.ca) (Canada).

All fees and programming subject to change. SiriusXM® satellite service is available only to those at least 18 and older in the 48 contiguous US and D.C. Our SiriusXM® satellite service is also available in Canada and Puerto Rico (with coverage limitations). SiriusXM® Internet radio service is available throughout their satellite service area and in AK. © 2022 SiriusXM® Radio Inc. SiriusXM® and all related marks and logos are trademarks of SiriusXM® Radio Inc.

This functionality is only available for radios equipped with a Satellite receiver. In order to receive satellite radio, the vehicle needs to be outside with a clear view to the sky.

If the screen shows "Acquiring Signal", you might have to change the vehicle's position in order to receive a signal. In most cases, the satellite radio does not receive a signal in underground parking garages or tunnels.

## No Subscription

Radios equipped with a Satellite receiver require a subscription to the SiriusXM® Service. When the radio does not have the necessary subscription, the radio is able to receive the Preview channel only.

## Acquiring SiriusXM® Subscription

To activate the SiriusXM® Satellite Radio subscription, US residents visit <https://www.siriusxm.com/phx/getlogin> or call: 1-800-643-2112

Canadian residents visit <https://www.siriusxm.ca/> or call: 1-888-539-7474.

### NOTE:

You will need to provide the SiriusXM® ID (RID) located at the bottom of the Channel 0 screen. The Satellite Mode is activated by a press of the SXM button on the touchscreen.

When in Satellite Mode:

- The SXM button on the touchscreen is highlighted.
- The SiriusXM® Presets are displayed at the top of the screen.
- The SiriusXM® Channel Number is displayed in the center.
- The Program Information is displayed at the bottom of the Channel Number.
- The SiriusXM® function buttons are displayed below the Program Information.

Tuning is done by operating the Tune Knob or by Direct Tune, similar to other Radio Bands.

In addition to the tuning operation functions common to all radio modes, the replay, Traffic/Weather button, and Favorite button functions are available in SiriusXM® Mode.



Uconnect 4 With 7-inch Display SiriusXM® Satellite Radio





5

- 1 — Browse
- 2 — Replay
- 3 — Seek Down Button ◀◀
- 4 — Direct Tune Button
- 5 — Seek Up Button ▶▶
- 6 — Audio Settings Button

## REPLAY

The replay function provides a means to store and replay up to 22 minutes of music audio and 48 minutes of talk radio. Once the channel is switched, content in replay memory is lost.

Press the Replay button on the touchscreen. The Play/Pause, Rewind/Forward and Live buttons will display at the top of the screen, along with the replay time. You can exit by pressing the Replay button on the touchscreen any time during the Replay Mode.

Play/Pause		Press the Pause/Play button on the touchscreen to pause the playing of live or rewound content at any time. Play can be resumed by pressing the Pause/Play button again on the touchscreen.
Rewind		Press the Rewind button on the touchscreen to rewind the content in steps of five seconds. Pressing the Rewind button on the touchscreen for more than two seconds rewinds the content. The radio begins playing the content at the point at which the press is released.
Forward		Each press of the Forward button on the touchscreen forwards the content in steps of five seconds. Forwarding of the content can only be done when the content is previously rewound, and therefore, cannot be done for live content. A continuous press of the Forward button on the touchscreen also forwards the content. The radio begins playing the content at the point at which the press is released.
Live		Press the Live button on the touchscreen to resume the playing of live content.

## FAVORITES

Press the Favorites button on the touchscreen to activate the favorites menu, which will time out within 20 seconds in absence of user interaction.

You can exit the Favorites Menu by a press of the X button.

The favorites feature enables you to set a favorite artist or song that is currently playing. The radio then uses this information to alert you when either the favorite artist or song is being played at any time by any of the SiriusXM® Channels.

The maximum number of favorites that can be stored in the Radio is 50.

**Favorite Artist:** While the song is playing, to set a favorite artist, press the Favorites button on the touchscreen and then the Favorite Artist button on the touchscreen.

**Favorite Song:** While the song is playing, to set a favorite song, press the Favorites button on the touchscreen and then the Favorite Song button on the touchscreen.

## BROWSE IN SXM



Uconnect 4 With 7-inch Display Browse Button

- 1 — All Button
- 2 — Presets Button
- 3 — Favorites Button
- 4 — Game Zone Button

Press the Browse button on the touchscreen to edit Presets, Favorites, Game Zone, and Jump settings, along with providing the SiriusXM® Channel List.

This Screen contains many submenus. You can exit submenus to return to a parent menu by pressing the Back arrow.

**All**

Press the All button on the Browse Screen. When pressing the All button, the following categories become available:

- **Channel List** Press the Channel List to display all the SiriusXM® Channel Numbers. You can scroll the Channel List by pressing the Up and Down arrows, located on the right side of the screen. Scrolling can also be done by operating the Tune/Scroll knob.
- **Genre List** Press the Genre button on the touchscreen to display a list of Genres. You can select any desired Genre by pressing the Genre List. The radio tunes to a channel with the content in the selected Genre.

**Presets — If Equipped**

Press the Presets button (if equipped) located at the left of the Browse screen.

You can scroll the Presets list by pressing the Up and Down arrows located at the right side of the screen. Scrolling can also be done by operating the Tune/Scroll knob as well.

**Preset Selection**

A preset can be selected by pressing any of the listed Presets, or by pushing the Enter/Browse button on the Tune/Scroll knob to select the currently highlighted Preset. When selected, the Radio tunes to the station stored in the Preset.

**Deleting A Preset**

A preset can be deleted in the Presets Browse screen by pressing the Trash Can icon for the corresponding preset.

**Favorites**

Press the Favorites button on the Browse screen.

The Favorites menu provides a means to edit the Favorites list and to configure the Alert Settings, along with providing a list of Channels currently airing any of the items in the Favorites list.

You can scroll the Favorites list by pressing the Up and Down arrows located at the right side of the screen. Scrolling can also be done by operating the Tune/Scroll knob as well.

**Remove Favorites**

Press the Remove Favorites tab at the top of the screen. Press the Delete All button on the touchscreen to delete all of the Favorites or press the Trash Can icon next to the Favorite to be deleted.

**Alert Settings**

Press the Alert Settings tab at the top of the Favorites screen. The Alert Settings menu allows you to choose from a visual alert or audible and visual alert when one of your favorites is airing on any of the SiriusXM® channels.

**Game Zone**

Press the Game Zone button, located at the left of the Browse screen. This feature provides you with the ability to select teams, edit the selection, and set alerts.

### On-Air

Press the On-Air tab at the top of the screen. The On-Air list provides a list of Channels currently airing any of the items in the Selections list, and pressing any of the items in the list tunes the radio to that channel.

### Select Team — If Equipped

Press the Select Team button on the touchscreen to activate the League Scroll list. Press the chosen league and a scroll list of all teams within the league will appear, then you can select a team by pressing the corresponding box. A check mark appears for all teams that are chosen.

### Remove Selection/Trash Can Icon

Press the Remove Selection tab at the top of the screen. Press the Delete All button on the touchscreen to delete all of the selections or press the Trash Can icon next to the selection to be deleted.

### Alert Settings

Press the Alert Setting tab at the top of the screen. The Alert Settings menu allows you to choose from “Alert me to on-air games upon start” or “Alert upon score update” or both when one or more of your selections is airing on any of the SiriusXM® channels.

### Tune Start

Tune Start begins playing the current song from the beginning when you tune to a music channel using one of the 12 presets. This feature occurs the first time the preset is selected during that current song.

### Setting Presets



Uconnect 4 With 7-inch Display Radio Presets

The Presets are available for all Radio Modes, and are activated by pressing any of the Preset buttons, located at the top of the screen.

When you are on a station that you wish to save as a preset, press and hold the numbered button on the touchscreen for more than two seconds.

The Radio stores up to 12 presets in each of the Radio Modes.

A total of six presets will appear on the screen. You can switch between the radio presets list by pressing the Arrow button located in the upper right of the radio touchscreen.

### PRESET FEATURES — IF EQUIPPED

#### Browse In AM/FM

When in either AM or FM, the Browse Screen provides a means to edit the Presets List and is entered by pushing the Enter/Browse button.

#### Scrolling Preset List

Once in the Browse Presets screen, you can scroll the preset list by rotation of the Tune/Scroll knob or by pressing the Up and Down Arrow keys, located on the right of the screen.

#### Preset Selection From List

A preset can be selected by pressing any of the listed Presets, or by pushing the Enter/Browse button on the Tune/Scroll knob to select the currently highlighted Preset.

When selected, the radio tunes to the station stored in the Presets.

## Deleting Presets

A preset can be deleted in the Presets Browse screen by pressing the Trash Can icon for the corresponding preset.

## Return To Main Radio Screen

You can return to the Main Radio Screen by pressing the X button or the Back Arrow button when in the Browse Presets screen.

## Audio Settings

Press the Audio button within the settings main menu to activate the Audio Settings screen.

The audio settings can also be accessed on the Radio Mode screen by pressing the Audio button. You can return to the Radio screen by pressing the X button.



Uconnect 4 With 7-inch Display

Audio Setting	Description
Balance/Fade	Press the Balance/Fade button on the touchscreen to balance audio between the front speakers or fade the audio between the rear and front speakers. Press the Front, Rear, Left or Right buttons or press and drag the red Speaker icon to adjust the Balance/Fade.
Equalizer	Press the + or - buttons or press and drag the level bar to increase or decrease each of the equalizer bands. The level value, which spans between plus or minus nine, is displayed at the top of each of the bands.
Speed Adjusted Volume	The Speed Adjusted Volume is adjusted by selecting from "Off", "1", "2", or "3". This alters the automatic adjustment of the audio volume with variation to vehicle speed. Volume increases automatically as speed increases to compensate for normal road noise.

<b>Audio Setting</b>	<b>Description</b>
<b>Surround Sound</b>	When Surround Sound is on, you can hear audio coming from every direction as in a movie theatre or home theatre system.
<b>Loudness</b>	When Loudness is on, the sound quality at lower volumes improves.
<b>AUX Volume Offset</b>	The AUX Volume Offset is adjusted by pressing + and – buttons. This alters the AUX input audio volume. The level value, which spans between plus or minus three, is displayed above the adjustment bar.
<b>Auto Play</b>	The Auto Play feature begins playing music as soon as a USB Media device is connected to one of the vehicle's Media USB ports, when it is turned on. Press Off to turn the setting off.
<b>Radio Off With Door</b>	The Radio Off With Door feature, when activated, keeps the radio on until the driver or passenger door is opened or when the Radio Off Delay selected time has expired.



## MEDIA MODE

### Operating Media Mode

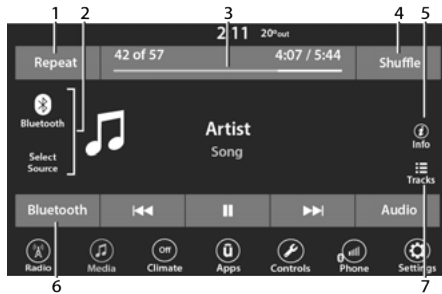

#### Uconnect 4 With 7-inch Display Operating Media Mode

- 1 – Repeat
- 2 – Select Source
- 3 – Track Time
- 4 – Shuffle
- 5 – Info
- 6 – Bluetooth®
- 7 – Tracks

## Audio Source Selection

Once in Media Mode, press the Source or Source Select button on the touchscreen and the desired mode button on the touchscreen. USB, AUX, and Bluetooth® are the Media sources available. When available, you can select the Browse button on the touchscreen to be given these options:

- Now Playing
- Artists
- Albums
- Genres
- Songs
- Playlists
- Folders

You can press the Source, Pause/Play, or the Info button on the touchscreen for artist information on the current song playing.

## Types of Media Modes

### USB MODE

#### Overview

USB Mode is entered by either inserting a USB device into the USB port or by selecting the USB button on the left side of the touchscreen, or the Source Select/Select Source button and then selecting USB 1 or 2 (if equipped).

## BLUETOOTH® MODE

#### Overview

Bluetooth® Streaming Audio or Bluetooth® Mode is entered by pairing a Bluetooth® device, containing music, to the Uconnect system.

Before proceeding, the Bluetooth® device must be paired to the Uconnect Phone to communicate with the Uconnect system.

To access Bluetooth® Mode, press the Bluetooth® button on the left side of the touchscreen or under the Source Select/Select Source button (if equipped).

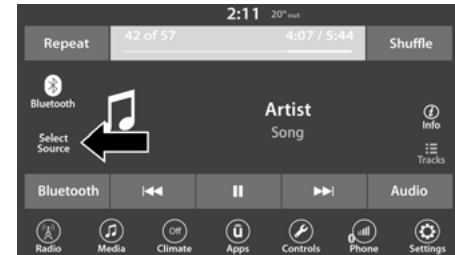

#### Uconnect 4 With 7-inch Display Select Source

## AUX MODE

### Overview

Auxiliary Mode (AUX) is entered by inserting an AUX device using a cable with a 3.5 mm audio jack into the AUX port or by pressing the AUX button on the left side of the touchscreen, or under the Source Select button (if equipped) when a device is already connected.

To insert an Auxiliary device, gently insert the Auxiliary device cable into the AUX port. If you insert an Auxiliary device with the ignition and the radio on, the unit will switch to AUX Mode and begin to play.

### Controlling The Auxiliary Device

The control of the Auxiliary device (e.g., selecting playlists, play, fast forward, etc.) cannot be provided by the radio; use the device controls instead. Adjust the volume with the Volume button, Volume & On/Off control knob, or Mute button, or with the volume of the attached device.

### NOTE:

The radio unit is acting as the amplifier for audio output from the Auxiliary device. Therefore, if the volume control on the Auxiliary device is set too low, there will be insufficient audio signal for the radio unit to play the music on the device.

### Seek Up ►► / Seek Down ◀◀

In USB Mode, press the Seek Up button on the touchscreen for the next selection on the USB device. Press and release the Seek Down button on the touchscreen to return to the beginning of the current selection, or to return to the beginning of the previous selection if the USB device is within the first three seconds of the current selection.

In Bluetooth® Mode, press and release the Seek Up button on the touchscreen for the next selection on the Bluetooth® device. Press and release the Seek Down button on the touchscreen to return to the beginning of the current selection, or return to the beginning of the previous selection if the Bluetooth® device is within the first second of the current selection.

### Browse

In USB Mode, press the Browse button on the touchscreen to display the browse window. In USB Mode, the left side of the browse window displays a list of ways you can browse through the contents of the USB device. If supported by the device, you can browse by Folder, Artist, Playlist, Album, Song, etc. Press the desired button on the touchscreen on the left side of the screen. The center of the browse window shows items and its sub-functions, which can be scrolled through by pressing the Up and Down buttons to the right. The Tune/Scroll knob can also be used to scroll.

### Media Mode

In USB Mode, press the Media button on the touchscreen to select the desired audio source: USB.

In Bluetooth® Mode, press the Media button on the touchscreen to select the desired audio source: Bluetooth®.

In AUX Mode, press the Media button on the touchscreen to select the desired audio source: AUX.

### Repeat

In USB Mode, press the Repeat button on the touchscreen to toggle the repeat functionality. The Repeat button on the touchscreen is highlighted when active. The Radio will continue to play the current track, repeatedly, as long as the repeat is active. Press the Repeat button again to enter Repeat All. The radio will continue to play all the current tracks, repeatedly, as long as the repeat function is active. To cancel Repeat, press the Repeat button a third time.

### Shuffle

In USB Mode, press the Shuffle button on the touchscreen to play the selections on the USB device in random order to provide an interesting change of pace. Press the Shuffle button on the touchscreen a second time to turn this feature off.

## Audio

Audio settings can be accessed by pressing the Audio button → page 138.

## Info

In both Disc and USB Modes, press the Info button on the touchscreen to display the current track information. Press the Info or X button on the touchscreen a second time to cancel this feature.

## Tracks

In both Disc and USB Modes, press the Tracks button on the touchscreen to display a pop-up with the Song List. The song currently playing is indicated by an arrow and lines above and below the song title. When in the Tracks List screen you can rotate the Tune/Scroll knob to highlight a track (indicated by the line above and below the track name) and then push the Enter/Browse knob to start playing that track.

In Bluetooth® Mode, if the Bluetooth® device supports this feature, press the Tracks button on the touchscreen to display a pop-up with the Song List. The currently playing song is indicated by a red arrow and lines above and below the song title.

Pressing the Tracks button on the touchscreen while the pop-up is displayed will close the pop-up.

## MEDIA VOICE COMMANDS

Uconnect offers connections via USB, Bluetooth®, and auxiliary (AUX) ports. Voice operation is only available for connected USB and AUX devices.

Push the VR button  located on the steering wheel. After the beep, say one of the following commands and follow the prompts to switch your media source or choose an artist:

- “Change source to Bluetooth®”
- “Change source to AUX”
- “Change source to USB”
- “Play artist Beethoven”; “Play album Greatest Hits”; “Play song Moonlight Sonata”; “Play genre Classical”

**Did You Know:** Press the Browse button on the touchscreen to see all of the music on your USB device. Your Voice Command must match exactly how the artist, album, song, and genre information is displayed.

## PHONE MODE

### Overview

Uconnect Phone is a voice-activated, hands-free, in-vehicle communications system. It allows you to dial a phone number with your mobile phone.

The feature supports the following:

### Voice Activated Features

- Hands-Free dialing via Voice (“Call John Smith Mobile” or “Dial 248-555-1212”).
- Hands-Free text-to-speech listening of your incoming SMS messages.
- Hands-Free Text Message Replying: Forward one of 18 predefined SMS messages to incoming calls/text messages.
- Redialing last dialed numbers (“Redial”).
- Calling Back the last incoming call number (“Call Back”).
- Viewing call logs on screen (“Show Incoming Calls,” “Show Outgoing Calls,” “Show Missed Calls,” or “Show Recent Calls”).
- Searching Contacts phone number (“Search for John Smith Mobile”).

### Screen Activated Features

- Dialing via Keypad using touchscreen.
- Viewing and Calling contacts from Phonebooks displayed on the touchscreen.
- Setting Favorite Contact phone numbers so they are easily accessible on the Main Phone screen.
- Viewing and Calling contacts from Recent Call logs.
- Reviewing your recent Incoming SMS Messages.
- Pairing up to 10 phones/audio devices for easy access to connect to them quickly.

#### NOTE:

Your phone must be capable of SMS messaging via Bluetooth® for messaging features to work properly.

Your mobile phone's audio is transmitted through your vehicle's audio system; the system will automatically mute your radio when using the Uconnect Phone.

For Uconnect customer support:

- US visit [UconnectPhone.com](http://UconnectPhone.com) or call 877-855-8400
- Canada visit [UconnectPhone.com](http://UconnectPhone.com) or call 800-465-2001 (English) or (French) call 800-387-9983

Uconnect Phone allows you to transfer calls between the system and your mobile phone as you enter or exit your vehicle and enables you to mute the system's microphone for private conversation.

#### WARNING!

ALWAYS drive safely with your hands on the steering wheel. You have full responsibility and assume all risks related to the use of the Uconnect features and applications in this vehicle. Only use Uconnect when it is safe to do so. Failure to do so may result in an accident involving serious injury or death.

The Phone feature is driven through your Bluetooth® "Hands-Free Profile" mobile phone. Uconnect features Bluetooth® technology — the global standard that enables different electronic devices to connect to each other without wires or a docking station. Ensure your phone is turned on with Bluetooth® active and has been paired to the Uconnect system. Up to 10 mobile phones or audio devices are allowed to be linked to the system. Only one linked (or paired) mobile phone and one audio device can be used with the system at a time.

### Phone Button

The Phone button  on your steering wheel is used to get into the Phone Mode and make calls, show recent, incoming or outgoing calls, view phonebook, etc. When you push the button you will hear a BEEP. The BEEP is your signal to give a command.

### Voice Command Button

The Voice Command button  on your steering wheel is only used for "barge in" and when you are already in a call or want to make another call.

The button on your steering wheel is also used to access the Voice Commands for the Uconnect Voice Command features if your vehicle is equipped.

### Phone Operation

#### OPERATION

Voice commands can be used to operate the Uconnect Phone and to navigate its menu structure. Voice commands are required after most Uconnect Phone prompts. There are two general methods for how Voice Command works:

1. Say compound commands like "Call John Smith mobile".
2. Say the individual commands and allow the system to guide you to complete the task.

You will be prompted for a specific command and then guided through the available options.

- Prior to giving a voice command, one must wait for the beep, which follows the “Listen” prompt or another prompt.
- For certain operations, compound commands can be used. For example, instead of saying “Call” and then “John Smith” and then “mobile”, the following compound command can be said: “Call John Smith mobile.”
- For each feature explanation in this section, only the compound command form of the voice command is given. You can also break the commands into parts and say each part of the command when you are asked for it. For example, you can use the compound command form voice command “Search for John Smith,” or you can break the compound command form into two voice commands: “Search Contacts” and when asked, “John Smith.” Please remember, the Uconnect Phone works best when you talk in a normal conversational tone, as if speaking to someone sitting a few feet/meters away from you.

## NATURAL SPEECH

Your Uconnect Phone Voice system uses a Natural Language Voice Recognition (VR) engine.

Natural speech allows the user to speak commands in phrases or complete sentences. The system filters out certain non-word utterances and sounds such as “ah” and “eh.” The system handles fill-in words such as “I would like to”.

The system handles multiple inputs in the same phrase or sentence such as “make a phone call” and “to Kelly Smith”. For multiple inputs in the same phrase or sentence, the system identifies the topic or context and provides the associated follow-up prompt such as “Who do you want to call?” in the case where a phone call was requested but the specific name was not recognized.

The system utilizes continuous dialog. When the system requires more information from the user, it will ask a question to which the user can respond without pushing the Voice Command button on the steering wheel.

## HELP COMMAND

If you need assistance at any prompt, or if you want to know your options at any prompt, say “Help” following the beep.

To activate the Uconnect Phone from idle, simply push the Phone button (if active) on your steering wheel and say a command or say “Help”. All Phone sessions begin with a push of the VR button or the Phone button.

## CANCEL COMMAND

At any prompt, after the beep, you can say “Cancel” and you will be returned to the main menu.

You can also push the VR button or Phone button on your steering wheel when the system is listening for a command and be returned to the main or previous menu.

## PAIR (LINK) UCONNECT PHONE TO A MOBILE PHONE

**Use this QR code to access your digital experience.**

To begin using your Uconnect Phone, you must pair your compatible Bluetooth®-enabled mobile phone. Mobile phone pairing is the process of establishing a wireless connection between a cellular phone and the Uconnect system.



To complete the pairing process, you will need to reference your mobile phone's manual. Please visit [UconnectPhone.com](http://UconnectPhone.com) for complete mobile phone compatibility information.



**Uconnect 4 With 7-inch Display**

**NOTE:**

- You must have Bluetooth® enabled on your phone to complete this procedure.
- The vehicle must be in PARK or at a standstill.

Follow these steps to pair your phone:

1. Place the ignition in the ACC or ON/RUN position.
2. Press the Phone button.

**NOTE:**

- If there are no phones currently connected with the system, a pop-up will appear asking if you would like to pair a mobile phone.
  - This pop-up only appears when the user enters Phone Mode and no other device(s) have previously been paired. If the system has a phone previously paired, even if no phone is currently connected with the system, this pop-up will not appear.
3. Select “Yes” to begin the pairing process.
  4. Search for available devices on your Bluetooth®-enabled mobile phone.
    - Press the Settings button on your mobile phone.
    - Select “Bluetooth®” and ensure it is enabled. Once enabled, the mobile phone will begin to search for Bluetooth® connections.

**NOTE:**

During the pairing procedure, you may receive a pop-up on your touchscreen asking you to make sure the PIN on the touchscreen matches the PIN from the pop-up on your mobile phone.

5. If “No” is selected, and you still would like to pair a mobile phone, press the Pairing or Settings button from the Uconnect Phone main screen.

- Press the Paired Phones button or the Add Device button.
  - Search for available devices on your Bluetooth®-enabled mobile phone. When prompted on the phone, select “Uconnect” and accept the connection request.
6. Uconnect Phone will display an in-progress screen while the system is connecting.
  7. When your mobile phone finds the Uconnect system, select “Uconnect.”
  8. When prompted on the mobile phone, accept the connection request from Uconnect.
  9. When the pairing process has successfully completed, the system will prompt you to choose whether or not this is your favorite phone. Selecting “Yes” will make this phone the highest priority. This phone will take precedence over other paired phones within range and will connect to the Uconnect system automatically when entering the vehicle. Only one mobile phone and/or one Bluetooth® audio device can be connected to the Uconnect system at a time. If “No” is selected, simply select “Uconnect” from the mobile phone/audio device Bluetooth® screen, and the Uconnect system will reconnect to the Bluetooth® device.

**NOTE:**

For phones which are not made a favorite, the phone priority is determined by the order in which it was paired. The most recent phone paired will have the higher priority.

**NOTE:**

During the pairing procedure, you may receive a pop-up on your mobile phone for the Uconnect system to access your “messages” and “contacts”. Selecting “Ok” or “Allow” will sync your contacts with the Uconnect system.

You can also use the following VR command to bring up the Paired Phone screen from any screen on the radio:

- “Show Paired Phones”

**NOTE:**

Software updates on your phone or the Uconnect system may interfere with the Bluetooth® connection. If this happens, simply repeat the pairing process. However, first make sure to delete the device from the list of phones on your Uconnect system. Next, be sure to remove Uconnect from the list of devices in your phone's Bluetooth® settings.

**PAIR A BLUETOOTH® STREAMING AUDIO DEVICE**

1. Press the Media button on the touchscreen to begin.
2. Change the source to “Bluetooth®”.
3. Press the Bluetooth® button on the touchscreen to display the Paired Audio Devices screen.
4. Press the Add Device button on the touchscreen.

**NOTE:**

If there is no device currently connected with the system, a pop-up will appear.

5. Search for available devices on your Bluetooth®-enabled audio device. When prompted on the device, confirm the PIN shown on the Uconnect screen.
6. Uconnect Phone will display an in-process screen while the system is connecting.
7. When the pairing process has successfully completed, the system will prompt you to choose whether or not this is your favorite device. Selecting “Yes” will make this device the highest priority. This device will take precedence over other paired devices within range.

**NOTE:**

For devices which are not made a favorite, the device priority is determined by the order in which it was paired. The most recent device paired will have the higher priority.

You can also use a following VR command to bring up a list of paired audio devices:

- “Show Paired Phones”

**CONNECTING TO A PARTICULAR MOBILE PHONE OR AUDIO DEVICE AFTER PAIRING**

Uconnect Phone will automatically connect to the highest priority paired phone and/or Audio Device within range. If you need to choose a particular phone or audio device follow these steps:

1. Press the Settings button on the touchscreen.
2. Press the Paired Phones/Audio Sources button.
3. Press to select the particular phone or the particular audio device. A pop-up menu will appear; press “Connect Phone”.
4. Press the X to exit out of the Settings screen.

## DISCONNECTING OR DELETING A PHONE OR AUDIO DEVICE

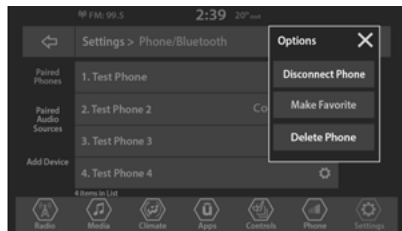

**Uconnect 4 With 7-inch Display**

1. Press the Uconnect Phone Pairing or Settings button.
2. Press the Paired Phones/Audio Sources button.
3. Press the Settings button located to the right of the device name for a different phone or audio device than the currently connected device or press the preferred Connected Phone from the list.
4. The option's pop-up will be displayed.
5. Press the Disconnect Device or the Delete Device button on the touchscreen.
6. Press the X to exit out of the Settings screen.

## MAKING A PHONE OR AUDIO DEVICE A FAVORITE

1. On the Paired Phone/Audio Sources screen, press the Settings button located to the right of the device name for a different phone or audio device than the currently connected device or press the preferred "Connected Phone" from the list.
2. The option's pop-up will be displayed.
3. Press the Make Favorite button on the touchscreen; you will see the chosen device move to the top of the list.
4. Press the X to exit out of the Settings screen.

## PHONEBOOK DOWNLOAD (AUTOMATIC PHONEBOOK TRANSFER FROM MOBILE PHONE) — IF EQUIPPED

If supported by your phone, Uconnect Phone has the ability to download contact names and number entries from the mobile phone's phonebook. Specific Bluetooth® Phones with Phonebook Access Profile may support this feature. Your mobile phone may receive a pop-up asking for permission for the Uconnect system to access your messages and contacts. Selecting "Ok" or "Allow" will sync your contacts with the Uconnect system.

See the Uconnect website, [UconnectPhone.com](http://UconnectPhone.com), for supported phones.

- To call a name from a downloaded mobile phonebook, follow the procedure in the "Voice Command" in this section.
- Automatic download and update of a phonebook, if supported, begins as soon as the Bluetooth® wireless phone connection is made to the Uconnect Phone, for example, after you start the vehicle.
- A maximum of 5,000 contact names with four numbers per contact will be downloaded and updated every time a phone is connected to the Uconnect Phone.
- Depending on the maximum number of entries downloaded, there may be a short delay before the latest downloaded names can be used. Until then, if available, the previously downloaded phonebook is available for use.
- Only the phonebook of the currently connected mobile phone is accessible.
- This downloaded phonebook cannot be edited or deleted on the Uconnect Phone. These can only be edited on the mobile phone. The changes are transferred and updated to Uconnect Phone on the next phone connection.



## MANAGING YOUR FAVORITES — IF EQUIPPED

There are two ways you can add an entry to your favorites:

1. After loading the mobile phonebook, press the Favorites button on the touchscreen, and then press one of the +Add Favorite Contact buttons that appears on the list.
2. After loading the mobile phonebook, select “Contacts” from the Phone main screen, and then select the appropriate number. Press the Down Arrow button or the Settings Gear button next to the selected number to display the option’s pop-up. In the pop-up, select “Add to Favorites”.

### NOTE:

If the Favorites list is full, you will be asked to remove an existing favorite.

## TO REMOVE A FAVORITE — IF EQUIPPED

1. To remove a Favorite, select “Favorites” from the Phone main screen.
2. Next, select the Down Arrow icon or the Settings Gear icon next to the contact you want to remove from your favorites. This will bring up the options for that Favorite contact.
3. Deselect the Star icon to delete the Favorite.

## Phone Call Features

The following features can be accessed through the Uconnect Phone if the feature(s) are available and supported by Bluetooth® on your mobile service plan. For example, if your mobile service plan provides three-way calling, this feature can be accessed through the Uconnect Phone. Check with your mobile service provider for the features that you have.

Here are the phone options with Uconnect:

- Redial
- Dial by pressing in the number
- Voice Commands (Dial by Saying a Name, Call by Saying a Phonebook Name, Redial or Call Back)
- Favorites
- Mobile Phonebook
- Recent Call Log
- SMS Message Viewer

## CALL CONTROLS

The touchscreen allows you to control the following call features:



Uconnect 4 With 7-inch Display

- 1 — Answer
- 2 — End
- 3 — Mute/Unmute
- 4 — Transfer
- 5 — Join Calls

Other phone call features include:

- End Call
- Hold/Unhold/Resume
- Swap two active calls

### KEY PAD NUMBER ENTRY

1. Press the Phone button.
2. Press the Dial/Keypad button on the touchscreen.
3. The Touch-Tone screen will be displayed.
4. Use the numbered buttons on the touchscreens to enter the number and press "Dial/Call".

### RECENT CALLS — IF EQUIPPED

You may browse a list of the most recent of each of the following call types:

- All Calls
- Incoming Calls or Calls Received
- Outgoing Calls or Calls Made
- Missed Calls

These can be accessed by pressing the Recent Calls button on the phone main screen.

You can also push the VR button on your steering wheel and perform the above operation. For example, say "Show my incoming calls".

### ANSWER OR IGNORE AN INCOMING CALL — NO CALL CURRENTLY IN PROGRESS

When you receive a call on your mobile phone, the Uconnect Phone will interrupt the vehicle audio system. Push the Phone button on the steering wheel, press the Answer button on the touchscreen.

You can also press the Caller ID box to place the current call on hold or answer the incoming call.



**Uconnect 4 With 7-inch Display**

- 1 — Answer Button
- 2 — Caller ID Box

### ANSWER OR IGNORE AN INCOMING CALL — CALL CURRENTLY IN PROGRESS

If a call is currently in progress and you have another incoming call, you will hear the same network tones for call waiting that you normally hear when using your mobile phone. Push the Phone button on the steering wheel, press the Answer button on the touchscreen, or press the Caller ID box to place the current call on hold and answer the incoming call.

#### NOTE:

Phones that are compatible with the Uconnect system in the market today do not support rejecting an incoming call when another call is in progress. Therefore, the user can only answer an incoming call or ignore it.

### DO NOT DISTURB

With Do Not Disturb, you can disable notifications from incoming calls and texts, allowing you to keep your eyes on the road and hands on the wheel. For your convenience, there is a counter display to keep track of your missed calls and text messages while Do Not Disturb is active.

Do Not Disturb can automatically reply with a text message, a call, or both when declining an incoming call and send it to voicemail.

Automatic reply messages can be:

- “I am driving right now, I will get back to you shortly”.
- Create a custom auto reply message up to 160 characters.

#### NOTE:

Only the first 25 characters can be seen on the touchscreen while typing a custom message.

While in Do Not Disturb, Conference Call can be selected so you can still place a second call without being interrupted by incoming calls.

#### NOTE:

- Reply with text message is not compatible with iPhone® devices.
- Auto reply with text message is only available on phones that support Bluetooth® Message Access Profile (MAP).

### PLACE/RETRIEVE A CALL FROM HOLD

During an active call, press the Hold or Call On Hold button on the Phone main screen.

### MAKING A SECOND CALL WHILE CURRENT CALL IS IN PROGRESS

You can place a call on hold by pressing the Hold button on the Phone main screen, then dial a number from the keypad (if supported by your mobile phone), recent calls, SMS Inbox or from the phonebooks.

### TOGGLING BETWEEN CALLS



Uconnect 4 With 7-inch Display

If two calls are in progress (one active and one on hold), press the Swap Calls button on the phone main screen. Only one call can be placed on hold at a time.

You can also push the Phone button to toggle between the active and held phone call.

### JOIN CALLS

When two calls are in progress (one active and one on hold), press the Join/Merge Calls button on the Phone main screen to combine all calls into a conference call.

### CALL TERMINATION

To end a call in progress, momentarily press the End Call button on the touchscreen or the Phone End button on the steering wheel. Only the active call(s) will be terminated and if there is a call on hold, it will become the new active call.

### REDIAL

Push the VR button  and after the “Listening” prompt and the following beep, say “Redial.”

The Uconnect Phone will call the last number that was dialed from your mobile phone.

### CALL CONTINUATION

Call continuation is the progression of a phone call on the Uconnect Phone after the vehicle ignition has been switched to OFF.

#### NOTE:

The call will remain within the vehicle audio system until the phone becomes out of range for the Bluetooth® connection. It is recommended to press the Transfer button on the touchscreen when leaving the vehicle.

## Advanced Phone Connectivity

### TRANSFER CALL TO AND FROM MOBILE PHONE

The Uconnect Phone allows ongoing calls to be transferred from your mobile phone without terminating the call. To transfer an ongoing call from your connected mobile phone to the Uconnect Phone or vice versa, press the Transfer button on the Phone main screen.

### Things You Should Know About Uconnect Phone

#### VOICE COMMAND

For the best performance:

- Always wait for the beep before speaking
- Speak normally, without pausing, just as you would speak to a person sitting a few feet/ meters away from you
- Ensure that no one other than you is speaking during a voice command period
- Low-To-Medium Blower Setting
- Low-To-Medium Vehicle Speed
- Low Road Noise
- Smooth Road Surface

- Fully Closed Windows
- Dry Weather Conditions

#### WARNING!

ALWAYS drive safely with your hands on the wheel. You have full responsibility and assume all risks related to the use of the Uconnect features and applications in this vehicle. Only use Uconnect when it is safe to do so. Failure to do so may result in an accident involving serious injury or death.

Even though the system is designed for many languages and accents, the system may not always work for some.

#### NOTE:

It is recommended that you do not store names in your Favorites phonebook while the vehicle is in motion.

Number and name recognition rate is optimized when the entries are not similar. You can say "O" (letter "O") for "0" (zero).

Even though international dialing for most number combinations is supported, some shortcut dialing number combinations may not be supported.

## Audio Performance

Audio quality is maximized under:

- Low-To-Medium Blower Setting
- Low-To-Medium Vehicle Speed
- Low Road Noise
- Smooth Road Surface
- Fully Closed Windows
- Dry Weather Conditions
- Operation From The Driver's Seat

Performance such as audio clarity, echo, and loudness to a large degree rely on the phone and network, and not the Uconnect Phone.

Echo at the far end can sometimes be reduced by lowering the in-vehicle audio volume.

#### Phone Voice Commands



Making and answering hands-free phone calls is easy with Uconnect. When the Phonebook button is illuminated on your touchscreen, your system is ready. Check UconnectPhone.com for mobile phone compatibility and pairing instructions.

Push the Phone button  and wait for the beep to say a command. See some examples:

- “Call John Smith”
- “Dial 123 456 7890”
- “Redial” (call previous outgoing phone number)
- “Call back” (call previously answered incoming phone number)

**Did You Know:** When providing a Voice Command, push the Phone button  and say “Call”, then pronounce the name **exactly** as it appears in your phonebook. When a contact has multiple phone numbers, you can say “Call John Smith **work**”.

#### Voice Text Reply – If Equipped

Uconnect can announce **incoming** text messages. Push the VR button  or Phone button  and say:

1. “Listen” to have the system read an incoming text message. (Must have compatible mobile phone paired to Uconnect system.)
2. “Reply” after an incoming text message has been read.  
Listen to the Uconnect prompts. After the beep, repeat one of the predefined messages and follow the system prompts.

PRE-DEFINED VOICE TEXT REPLY RESPONSES		
Yes.	Stuck in traffic.	See you later.
No.	Start without me.	I'll be late.
Okay.	Where are you?	I will be 5 <or 10, 15, 20, 25, 30, 45, 60> minutes late.
Call me.	Are you there yet?	
I'll call you later.	I need directions.	See you in 5 <or 10, 15, 20, 25, 30, 45, 60> minutes.
I'm on my way.	Can't talk right now.	
I'm lost.		Thanks.

#### NOTE:

Only use the numbering listed in the provided table. Otherwise, the system will not transpose the message.

**Did You Know:** Your mobile phone must have the full implementation of the **Message Access Profile (MAP)** to take advantage of this feature. For details about MAP, visit [UconnectPhone.com](http://UconnectPhone.com).

Apple® iPhone® iOS 5 or later supports reading **incoming** text messages only. For further information on how to enable this feature on your Apple® iPhone®, refer to your iPhone® “User Manual”.

**Did You Know:** Voice Text Reply is not compatible with iPhone®, but if your vehicle is equipped with Siri® Eyes Free, you can use your voice to send a text message.

#### Siri® Eyes Free – If Equipped

When used with your Apple® iPhone® connected to your vehicle via Bluetooth®, Siri lets you use your voice to send text messages, select media, place phone calls and much more. Siri uses your natural language to understand what you mean and responds back to confirm your requests. The system is designed to keep your eyes on the road and your hands on the wheel by letting Siri help you perform useful tasks.

To enable Siri, push and hold, then release the Uconnect Voice Recognition (VR) button on the steering wheel. After you hear a double beep, you can ask Siri to play podcasts and music, get directions, read text messages, and many other useful requests.

## BLUETOOTH® COMMUNICATION LINK

Mobile phones may lose connection to the Uconnect Phone. When this happens, the connection can generally be re-established by restarting the mobile phone. Your mobile phone is recommended to remain in Bluetooth® ON mode.

## POWER-UP

After switching the ignition key from OFF to either the ON/RUN or ACC position, or after a language change, you must wait at least 15 seconds prior to using the system ↪ page 318.

## ANDROID AUTO™ & APPLE CARPLAY® — IF EQUIPPED

### ANDROID AUTO™

Use this QR code to access your digital experience.

Android Auto™ is a feature of your Uconnect system, and your Android™ 6.0 or higher powered smartphone with a data plan, that allows you to project your smartphone and a number of its apps onto the touchscreen radio display. Android Auto™ brings you useful information, and organizes it into simple cards that appear just when they are needed.



Android Auto™ can be used with speech technology, the steering wheel controls, the knobs and buttons on your radio faceplate, and the radio display's touchscreen to control many of your apps. To use Android Auto™, perform the following procedure:

### NOTE:

Feature availability depends on your carrier and mobile phone manufacturer. Some Android Auto™ features may or may not be available in every region and/or language.

1. Download the Android Auto™ app from the Google Play store on your Android™-powered smartphone.
2. Connect your Android™-powered smartphone to one of the media USB ports in your vehicle. If the Android Auto™ app was not downloaded, the first time you plug your device in the app begins to download. Your vehicle should be in PARK the first time you use the app.

### NOTE:

Be sure to use the factory-provided USB cable that came with your phone, as aftermarket cables may not work.

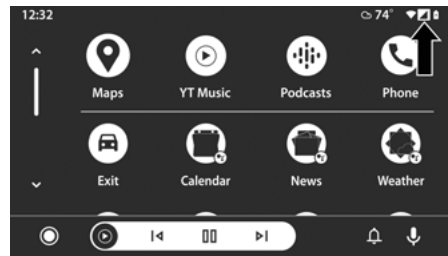

Android Auto™ And LTE Data Coverage

### NOTE:

To use Android Auto™, make sure you are in an area with cellular coverage. Android Auto™ may use cellular data and your cellular coverage is shown in the upper right corner of the radio screen. Data plan rates apply.

3. Once the device is connected and recognized, the Phone icon on the drag & drop menu bar changes to the Android Auto™ icon.

### NOTE:

Android Auto™ is set to launch immediately once a compatible device is connected. You can also launch it by pressing the Android Auto™ icon on the touchscreen.

Once Android Auto™ is up and running on your Uconnect system, the following features can be utilized using your smartphone's data plan:

- Google Maps™ for navigation
- Google Play Music, Spotify, iHeart Radio, etc. for music
- Hands-free calling and texting for communication
- Various compatible apps

## Maps



Push and hold the Voice Recognition (VR) button on the steering wheel until the beep or tap the Microphone icon to ask Google to take you to a desired

destination by voice. You can also touch the Navigation icon in Android Auto™ to access other navigation apps.

While using Android Auto™, Google Maps™ provides voice-guided:

- Navigation
- Live traffic information
- Lane guidance

For further information, refer to [www.android.com/auto/](http://www.android.com/auto/) (US) or [https://www.android.com/intl/en\\_ca/auto/](http://www.android.com/intl/en_ca/auto/) (Canada).

For further information on the navigation function, please refer to <https://support.google.com/android> or <https://support.google.com/androidauto/>.

## Music



Android Auto™ allows you to access and stream your favorite music with apps like YouTube Music, iHeartRadio, and Spotify. Using your smartphone's data plan, you can stream endless music on the road.

### NOTE:

Music apps, playlists, and stations must be set up on your smartphone prior to using Android Auto™ for them to work with Android Auto™.

### NOTE:

To see the track details for the music playing through Android Auto™, select the Uconnect system's media screen.

For further information, refer to <https://support.google.com/androidauto>.

## Communication



With Android Auto™ connected, push and hold the VR button on the steering wheel to activate voice recognition specific to Android Auto™. This allows you to send and reply to text messages, have incoming text messages read out loud, and place and receive hands-free calls.

## Apps

The Android Auto™ App displays all the compatible apps that are available to use with Android Auto™, every time it is launched. You must have the compatible app downloaded, and you must be signed in to the app through your mobile device for it to work with Android Auto™.

Refer to <https://play.google.com/store/apps/> to see the latest list of available apps for Android Auto™.

## Android Auto™ Voice Command

### NOTE:

Feature availability depends on your carrier and mobile phone manufacturer. Some Android Auto™ features may or may not be available in every region and/or language.

Android Auto™ allows you to use your voice to interact with its best-in-class speech technology through your vehicle's voice recognition system, and use your smartphone's data plan to project your Android™-powered smartphone and a number of its apps onto your Uconnect touchscreen. Connect your Android™ 6.0 or higher to one of the media USB ports, using the factory-provided USB cable, and press the new Android Auto™ icon that replaces your Phone icon on the main menu bar to begin Android Auto™.

Push and hold the VR button on the steering wheel, or press and hold the Microphone icon within Android Auto™, to activate its VR, which recognizes natural voice commands, to use a list of your smartphone's features:

- Maps
- Music
- Phone
- Text Messages
- Additional Apps

**NOTE:**

- Requires compatible smartphone running Android™ 6.0 or higher and download app on Google Play. Android™, Android Auto™, and Google Play are trademarks of Google Inc. Android Auto™ may be downloaded automatically depending on the software version installed on your mobile device.
- To wirelessly use Android Auto™ on your car display, you need a compatible Android™ smartphone with an active data plan. You can check which smartphones are compatible at [g.co/androidauto/requirements](http://g.co/androidauto/requirements).

Android™ is a trademark of Google Inc.

## APPLE CARPLAY®

**Use this QR code to access your digital experience.**

Uconnect works seamlessly with Apple CarPlay®, the smarter, more secure way to use your iPhone® in the car, and stay focused on the road. Use your Uconnect Touchscreen display, the vehicle's knobs and controls, and your voice with Siri to get access to Apple Music®, Maps, Messages, and more.



**NOTE:**

Feature availability depends on your carrier and mobile phone manufacturer. Some Apple CarPlay® features may or may not be available in every region and/or language.

To use Apple CarPlay®, make sure you are using iPhone® 5 or later, have Siri enabled in Settings, ensure your iPhone® is unlocked for the very first connection only, and then use the following procedure:

1. Connect your iPhone® to one of the media USB ports in your vehicle.

**NOTE:**

Be sure to use the factory-provided Lightning cable that came with your phone, as aftermarket cables may not work.

2. Once the device is connected and recognized, the Phone icon on the drag & drop menu bar changes to the Apple CarPlay® Icon.

**NOTE:**

Apple CarPlay® is set to launch immediately. You can also launch it by pressing the Apple CarPlay® icon on the touchscreen.

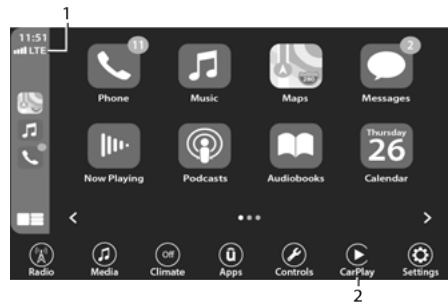

**Apple CarPlay® And LTE Data Coverage**

1 – LTE Data Coverage

2 – Apple CarPlay® Icon



**NOTE:**

To use Apple CarPlay®, make sure that cellular data is turned on, and that you are in an area with cellular coverage. Your data and cellular coverage is shown on the left side of the radio screen. Data plan rates apply.

Once Apple CarPlay® is up and running on your Uconnect system, the following features can be utilized using your iPhone® data plan:

- Phone
- Music
- Messages
- Maps

**Phone**

With Apple CarPlay®, push and hold the VR button on the steering wheel to activate a Siri voice recognition session.

You can also press and hold the Home button within Apple CarPlay® to start talking to Siri. This allows you to make calls or listen to voicemail as you normally would using Siri on your iPhone®.

**NOTE:**

Only temporarily pushing the VR button on the steering wheel launches a built-in Uconnect VR session, not a Siri session, and it will not function with Apple CarPlay®.

**Music**

Apple CarPlay® allows you to access all your artists, playlists, and music from iTunes® or any third party application installed on your device. Using your iPhone® data plan, you can also use select third party audio apps including music, news, sports, podcasts, and more.

**Messages**

Push and hold the VR button on the steering wheel to activate a Siri voice recognition session. Apple CarPlay® allows you to use Siri to send or reply to text messages. Siri can also read incoming text messages, but drivers will not be able to read messages, as everything is done via voice.

**Maps**

Push and hold the VR button on the steering wheel until the beep or tap the Microphone icon to ask Apple® Siri to take you to a desired destination by voice. You can also touch the Navigation icon in Apple CarPlay® to access Apple® Maps.

**Apps**

The Apple CarPlay® App plays all compatible apps that are available to use, every time it is launched. You must have the compatible app downloaded, and you must be signed in to the app through your mobile device for it to work with Apple CarPlay®.

Refer to <http://www.apple.com/ios/carplay/> (US) or <https://www.apple.com/ca/ios/carplay/> (Canada) to see the latest list of available apps for Apple CarPlay®.

## Apple CarPlay® Voice Command

### NOTE:

Feature availability depends on your carrier and mobile phone maker. Some Apple CarPlay® features may not be available in every region and/or language.

Apple CarPlay® allows you to use your voice to interact with Siri through your vehicle's voice recognition system, and use your smartphone's data plan to project your iPhone® and a number of its apps onto your Uconnect touchscreen. Connect your iPhone® 5 or higher to one of the media USB ports, using the factory-provided Lightning cable, and press the new Apple CarPlay® icon that replaces your Phone icon on the main menu bar to begin Apple CarPlay®. Push and hold the VR button on the steering wheel, or press and hold the Home button within Apple CarPlay®, to activate Siri, which recognizes natural voice commands to use a list of your iPhone® features:

- Phone
- Music
- Messages
- Maps — If Equipped
- Additional Apps — If Equipped

### NOTE:

Apple CarPlay® is a trademark of Apple® Inc. iPhone® is a trademark of Apple® Inc., registered in the US and other countries. Apple® terms of use and privacy statements apply.

## ANDROID AUTO™ AND APPLE CARPLAY® TIPS AND TRICKS

### Android Auto™ And Apple CarPlay® Automatic Bluetooth® Pairing

After connecting to Android Auto™ or Apple CarPlay® for the first time and undergoing the setup procedure, the smartphone pairs to the Uconnect system via Bluetooth® without any setup required every time it is within range, if Bluetooth® is turned on.

### NOTE:

Apple CarPlay® uses a USB connection while Android Auto™ uses both USB and Bluetooth® connections to function. The connected device is unavailable to other devices when connected using Android Auto™ or Apple CarPlay®.

### Multiple Devices Connecting To The Uconnect System — If Equipped

It is possible to have multiple devices connected to the Uconnect system. For example, if using Android Auto™/Apple CarPlay®, the connected device will be used to place hands-free phone calls or send hands-free text messages. However, another device can also be paired to the Uconnect system, via Bluetooth®, as an audio source, so the passenger can stream music.

### NOTE:

Apple CarPlay® and Android Auto™ can only be launched from the front and center console USB ports.

## PERFORMANCE PAGES

Performance Pages is an application that provides a display for performance indicators, as received from the instrument cluster, that will help you gain familiarity with the capabilities of your vehicle in real time.

To access the Performance Pages, press the Apps button on the touchscreen then press the Performance Pages button on the touchscreen. Press the desired button on the touchscreen to access that specific Performance Page.

**WARNING!**

Measurement of vehicle statistics with the Performance Pages is intended for off-highway or off-road use only and should not be done on any public roadways. It is recommended that these features be used in a controlled environment and within the limits of the law. The capabilities of the vehicle as measured by the Performance Pages must never be exploited in a reckless or dangerous manner, which can jeopardize the user's safety or the safety of others. Only a safe, attentive, and skillful driver can prevent accidents.

The Performance Pages include the following:

- Home
- Timers
- Gauges
- G-Force
- Engine
- Dyno

If a USB drive is installed in the media hub, press the Camera icon on the top right of the touchscreen when using Performance Pages. A screen shot of the page will be taken and saved onto the USB.

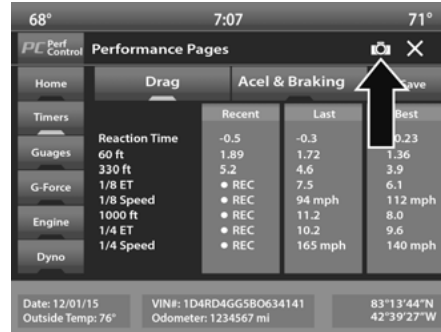

**Screenshot Camera Button**

The following describes each feature and its operation:

## HOME



**Performance Pages – Home**

When Home is selected, a series of widgets (gauges) can be customized by the user. Follow these steps to change a widget. Either press directly on the widget you want to change, or:

1. Press the Settings button (gear icon) on the touchscreen to access the main menu for the widgets.

2. Select one the following options from the menu:
  - Set Widget: Top Left
  - Set Widget: Top Right
  - Set Widget: Bottom Left
  - Set Widget: Bottom Right
3. After selecting a widget location, select the gauge to display:
  - Gauge: Oil Temp
  - Gauge: Oil Pressure
  - Gauge: Coolant Temp
  - Gauge: Battery Voltage
  - Gauge: Trans Temp – If Equipped with an Automatic Transmission
  - Gauge: Boost Pressure – If Equipped
  - Gauge: Air/Fuel Ratio – If Equipped
  - Gauge: I/C Coolant Temp – If Equipped
  - Gauge: Intake Air Temp
  - Gauge: Engine Torque
  - Gauge: Engine Power
  - Gauge: G-Force
  - Gauge: Steering Angle
  - Gauge: Current Gear
  - Gauge: Current Speed
  - Timer: 0–60 mph (0–100 km/h)
  - Timer: 0–100 mph (0–160 km/h)
  - Timer: 60 ft (20 m)
  - Timer: 330 ft (100 m)
  - Timer: 1/8 Mile (200 m)
  - Timer: 1000 ft (300 m)
  - Timer: 1/4 Mile (400 m)
  - Timer: Braking Distance
  - Timer: Reaction Time

### Historical Data

The Historical Data feature allows you to view information about your vehicle such as the VIN, miles on the odometer, longitude and latitude coordinates, and more.

To activate the Historical Data feature on your touchscreen, follow these steps:

1. Select the Home page tab within Performance Pages. Then, press the settings icon (gear icon) in the upper right hand corner of the touchscreen.



**Home Page Settings**

2. Towards the bottom of the screen, a checkbox will appear next to "Include historical data in screenshot." Click the box to signify that this feature will be on.



Historical Data

**NOTE:**

Once the checkbox is selected, the bottom bar of the screen will be replaced with the historical data from your vehicle present at the time the screenshot icon was pressed.



Historical Data

- 1 – Outside Temperature
- 2 – Date
- 3 – Odometer
- 4 – Vehicle Identification Number (VIN)
- 5 – Longitude And Latitude Coordinates

3. To take a screenshot of the historical data, make sure a USB device is plugged into the vehicle. Next, click the Camera icon located in the top right corner of the touchscreen. The historical data image file will be saved to the USB drive.

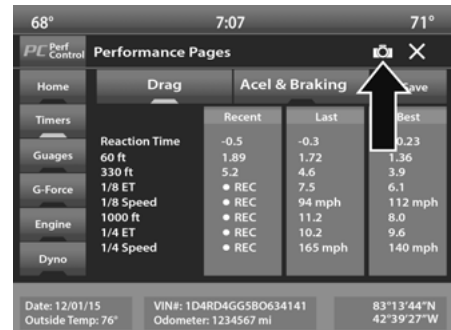

Historical Data Camera Icon

## TIMERS



### Performance Pages – Timers

When the Timers Page is selected, you will be able to select the Drag or Accl & Braking tabs. The following will be displayed:

- **Recent**

The most recent successful run of performance timers. If a run does not complete within the timers limit, or is aborted, the values shown will revert to the most recent valid run.

- **Last**

The last recorded successful run of performance timers.

- **Best**

The best recorded run of performance timers, except for braking data.

- **Save**

Pressing the Save button will let you save the visible page, Recent/Last/Best. Any saved run over 10 will overwrite the last saved run for Uconnect system storage.

**NOTE:**

Pressing the Camera icon in the upper right corner of the screen at any time will save a screenshot of the screen currently being viewed to the connected USB device.

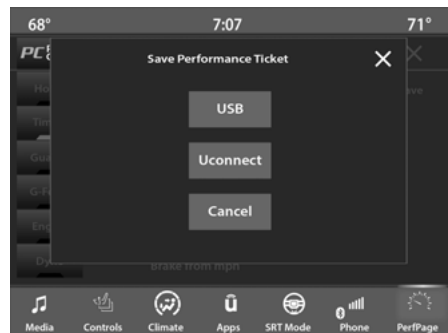

### Save

- With a USB jump drive installed, press the USB button to save to the jump drive.
- Press the Uconnect button to save the runs to the Owner web page.

**NOTE:**

Uconnect option will be grayed out or missing if the vehicle does not have a valid Uconnect account associated with it.

- Press the Cancel button to return to the Timers page.

The tabs on the Timers page contain the following timers:

- *Reaction Time*

Measures the driver's reaction time for launching the vehicle against a simulated drag strip timing light (behavior modeled after 500 Sportsman Tree) displayed in the instrument cluster display.

**NOTE:**

Drag timers (RT, 60 ft [20 m], 330 ft [100 m], 1/8 mile [200 m], 1000 ft [300 m], and 1/4 mile [400 m]).

**NOTE:**

Accel & Braking timers (0-60 mph [0-100 km/h], 0-100 mph [0-160 km/h], Brake from mph [km/h], and Brake Distance ft [meters]).

- *0-60 mph (0-100 km/h)*

Displays the time it takes for the vehicle to go from 0 to 60 mph (0 to 100 km/h).

- *0-100 mph (0-160 km/h)*

Displays the time it takes for the vehicle to go from 0 to 100 mph (0 to 160 km/h).

- *60 ft (20 m) ET*

Displays the time it takes the vehicle to go 60 feet (20 m).

- *330 ft (100 m) ET*

Displays the time it takes the vehicle to go 330 feet (100 m).

- *1/8 Mile (200 m) ET*

Displays the time it takes for the vehicle to go 1/8 mile (200 m).

- *1/8 Mile (200 m) mph*

Displays the vehicle speed at the time 1/8 mile (200 m) was reached.

- *1000 ft (300 m) ET*

Displays the time it takes the vehicle to go 1000 ft (300 m).

- *1/4 Mile (400 m) ET*

Displays the time it takes for the vehicle to go 1/4 mile (400 m).

- *1/4 Mile (400 m) mph*

Displays the speed the vehicle was at when 1/4 mile (400 m) was reached.

- *Brake Distance ft (meters)*

Displays the distance it takes the vehicle to make a complete stop.

**NOTE:**

The distance measurement will be aborted if the brake pedal is released or the parking brake is engaged, before the vehicle comes to a complete stop.

- *Brake from mph (km/h)*

Displays the speed the vehicle is traveling when the brake pedal is pressed.

**NOTE:**

Brake Distance and Speed timers only display "ready" when vehicle is traveling at greater than 30 mph (48 km/h).

## GAUGES



**Performance Pages – Gauges**

When selected, this screen displays the following values:

- **Oil Temperature**  
Shows the actual oil temperature.
- **Oil Pressure**  
Shows the actual oil pressure.

- **Coolant Temperature**  
Shows the actual coolant temperature.
- **Battery Voltage**  
Shows actual battery voltage.
- **Trans Oil Temp – If Equipped with an Automatic Transmission**  
Shows actual transmission oil temperature.
- **Boost Pressure – If Equipped**  
Shows actual boost pressure.
- **Air Fuel Ratio – If Equipped**  
Shows current air fuel ratio.
- **I/C Coolant Temp – If Equipped**  
Shows actual I/C Coolant temperature.
- **Intake Air Temp**  
Shows actual air intake temperature.

If a gauge is selected, the Gauge Detail View page will appear on the screen. This page shows gauge values for the previous two minutes on the selected gauge.

Pressing the Left and Right arrows will cycle through the details for each of the gauges. Pressing the minimize button above the graph will return to the gauge menu.



**Gauge Detail View Page**



## G-FORCE



**Performance Pages – G-Force**

When selected, this screen displays all four G-Force values as well as steering angle.

When G-Force is selected, the following features will be available:

- **Vehicle Speed:**  
Measures the current speed of the vehicle in either mph or km/h, starting at zero with no maximum value.
- **Front G-Force:**  
Measures the peak braking force on the front of the vehicle.
- **Right G-Force:**  
Measures the peak force on the right side of the vehicle.
- **Left G-Force:**  
Measures the peak force on the left side of the vehicle.
- **Rear G-Force:**  
Measures the peak acceleration force on the rear of the vehicle.

### NOTE:

Front, Right, Left, and Rear G-Forces are all peak values. These readings can be reset by clearing peak G-Force on the instrument cluster.

- **Steering Wheel Angle**

Steering Wheel Angle utilizes the steering angle sensor to measure the degree of the steering wheel relative to zero (straight ahead) reference angle. The zero degree reference angle measurement indicates a steering wheel straight ahead position.

The friction circle display shows instantaneous G-Force as a highlight and previous G-Force as dots within the circle. The system records previous G-Force for three minutes. If there are multiple samples at a given point, the color of the dot will darken from blue to red. Vectors more frequent will show in red; infrequent vectors will show in blue.

## ENGINE



Performance Pages – Engine

When selected, this screen displays the following values:

- *Vehicle Speed*  
Shows the actual vehicle speed.
- *Engine Power*  
Shows the instantaneous power.

- *Engine Torque*  
Shows the instantaneous torque.
- *Oil Pressure (6.4L Only) – If Equipped*  
Shows the actual engine oil pressure.
- *Boost Pressure (6.2L Only) – If Equipped*  
Shows the actual boost pressure.
- *Gear (Automatic Transmission Only)*  
Shows the current (or pending) operating gear of the vehicle.

## DYNAMOMETER (DYNO)



Performance Pages – Dyno

The system will start drawing graphs for Power and Torque (top chart) and Engine Speed (bottom chart). The graph will fill to the right side of the page (based on History time selected). Once the right side of the page is reached, the graph will scroll with the right side always being the most recent recorded sample.

The following options can be selected:

- Pressing the STOP button will freeze the graph. Selecting Play will clear the graph and restart the process over.
- Press the + or - button to change the history of the graph. The selectable options are “30”, “60”, “90”, and “120” seconds. The graph will expand or constrict depending on the setting selected.
- Select the “Gear” display setting to turn the graph gear markers on and off for automatic transmission vehicles only.

### NOTE:

The Gear on/off feature will only display if your vehicle is equipped with an Automatic Transmission.

## DODGE DRIVE MODES — IF EQUIPPED

### PERFORMANCE CONTROL — IF EQUIPPED

Your vehicle may be equipped with a Performance Control feature which allows for coordinating the operation of various vehicle systems depending upon the type of driving behavior desired. The Performance Control feature is controlled through the Uconnect system and may be accessed by performing any of the following:

- Pushing the Super Track Pack button on the instrument panel switch bank.
- Selecting “Performance Control” from the “Apps” menu.
- Selecting “Performance Control” from within the Performance Pages menu.

You will be able to enable, disable, and customize the functionality of the Launch Control and Performance Control Set-Up features within Performance Control.

To access information about the functionality of these features through the Uconnect system, press the Info button on the touchscreen.

#### NOTE:

Dodge vehicles equipped with a 6.4L engine, except for R/T Scat Pack 1320 6.4L non-widebody vehicles, will use SRT Drive Modes rather than the Dodge Performance Control Pages. Please refer to the following sections for further information on the SRT Drive Modes.

### Drive Mode Set-Up

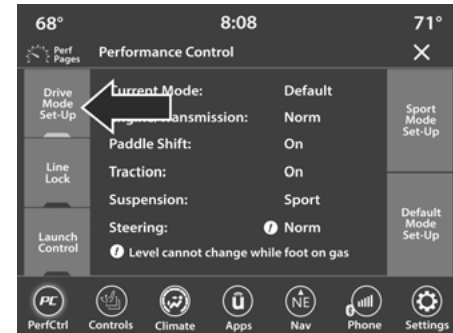

#### Performance Control Set-Up

Pressing the Drive Mode Set-Up button on the touchscreen within the Performance Control screen indicates the real-time status of the various systems. Pressing the Sport Mode Set-Up, Drag Mode Set-Up (1320 only), or Default Mode Set-Up buttons on the touchscreen allows the driver to configure their individual performance control and see how those configurations affect the performance of the vehicle.

**NOTE:**

Not all of the options listed in this manual are available on every vehicle. Here is a chart with all available Performance Control vehicle configurations:

**Available Mode Configurations**

<b>Engine</b>	If Manual Transmission
<b>Engine/Transmission</b>	If Auto Transmission
<b>Steering</b>	X
<b>Paddle Shifters</b>	If Auto Transmission
<b>Traction Control</b>	X
<b>Suspension</b>	If Adaptive Suspension

Refer to the Sport and Default Modes for their detailed operation.

**NOTE:**

These settings will remain in effect when using the Launch Control feature.

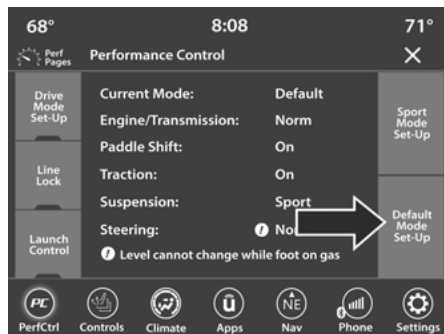
**Default Mode****Default Mode**

The vehicle will always start in Default Mode. This mode is for typical driving conditions. While in Default Mode, the Engine, Transmission and Traction will operate in their Normal settings and cannot be changed. The Steering Assist may be configured to “Normal”, “Sport”, or “Comfort” by pressing the corresponding buttons on the touchscreen. The Paddle Shifters (if equipped) may be enabled or disabled while in this mode.



Default Mode Set-Up

## Launch Control

### WARNING!

Launch Control is intended for off-highway or off-road use only and should not be used on any public roadways. It is recommended that this feature be used in a controlled environment, and within the limits of the law. The capabilities of the vehicle as measured by the performance pages must never be exploited in a reckless or dangerous manner, which can jeopardize the user's safety or the safety of others. Only a safe, attentive, and skillful driver can prevent accidents.

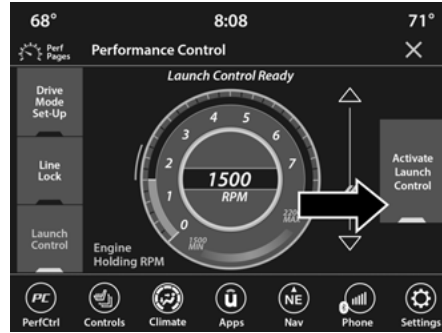

Launch Control

This vehicle is equipped with a Launch Control system that is designed to allow the driver to achieve quick, consistent vehicle acceleration in a straight line. Launch Control is a form of traction control that manages tire slip while launching the vehicle. This feature is intended for use during race events on a closed course where consistent quarter-mile and 0-to-60 times are desired.

The system is not intended to compensate for lack of driver experience or familiarity with the race track. Use of this feature in low traction (cold, wet, gravel, etc.) conditions may result in excess wheel slip outside this system's control resulting in an aborted launch.

### NOTE:

- Launch Control should not be used on public roads. Always check track conditions and the surrounding area.
- Launch Control is not available for the first 500 miles (805 km) of the vehicle's life.
- Launch Control should only be used when the engine and transmission are at operating temperature.
- Launch Control is intended to be used on dry, paved road surfaces only. Use on slippery or loose surfaces may cause damage to vehicle components and is not recommended.
- Launch Control is not available in ESC Full Off mode.

## Sport Mode

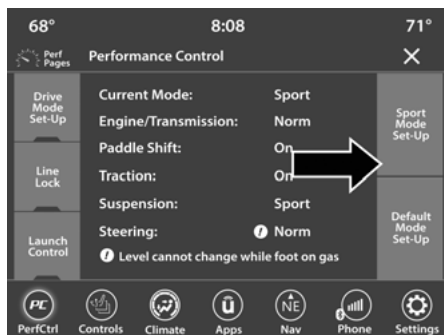

### Sport Mode

Sport Mode is a configuration set-up for typical enthusiast driving. The Transmission and Steering are both set to their Sport settings. The steering wheel Paddle switches are enabled. Traction Control defaults to Normal. Any of these four settings may be changed to the driver's preferences by pressing the buttons on the touchscreen. Push the Sport button on the instrument panel switch bank to put the vehicle in Sport Mode and activate these settings. The customized settings will only be active when the Sport button is active.

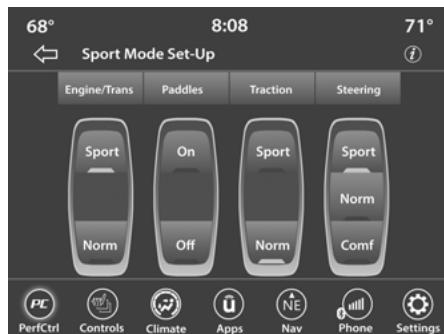

### Sport Mode Set-Up

Possible Performance Control configurations are listed with accompanying descriptions.

The information contained in the list can also be accessed from within the mode Set-Up menus. To access the information, press the Info button on the touchscreen from the mode Set-Up menu, and use the Left/Right arrows to toggle through available descriptions. The title for each system in the Set-Up menu can be pressed, which provides the descriptions for each function of that system.

## ENGINE/TRANS (IF EQUIPPED WITH AUTOMATIC TRANSMISSION)

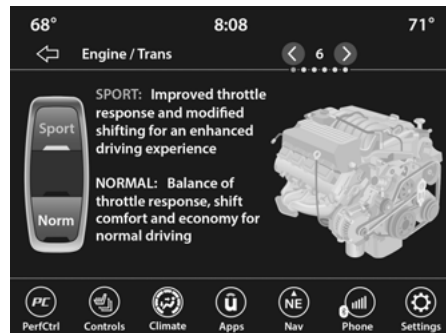

### Engine/Trans

- **SPORT**

Press the Sport button on the touchscreen for improved throttle response and modified shifting for an enhanced driving experience.

- **NORMAL**

Press the Normal button on the touchscreen for a balance of throttle response, shift comfort and economy for normal driving.

## PADDLE SHIFTERS – IF EQUIPPED WITH AUTOMATIC TRANSMISSION

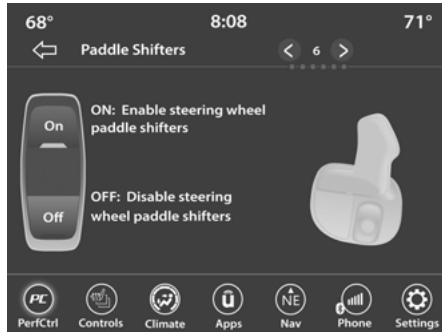

### Paddle Shifters – Automatic Transmission

- **ON**  
Press the On button on the touchscreen to enable steering wheel Paddle Shifters.
- **OFF**  
Press the Off button on the touchscreen to disable steering wheel Paddle Shifters.

## TRACTION



### Traction Control

- **SPORT**  
Press the Sport button on the touchscreen to turn off traction control and reduce stability control.
- **NORMAL**  
Press the Normal button on the touchscreen to provide full traction control and full stability control.

## STEERING – IF EQUIPPED



### Steering

- **SPORT**  
Press the Sport button on the touchscreen to provide an increased amount of steering feel, requiring a higher amount of steering effort.
- **NORMAL**  
Press the Normal button on the touchscreen to provide a balanced steering feel and steering effort. This is also your vehicle's preset steering setting.
- **COMFORT**  
Press the Comfort button on the touchscreen to provide a lower steering effort.

## RADIO OPERATION AND MOBILE PHONES

Under certain conditions, the mobile phone being on in your vehicle can cause erratic or noisy performance from your radio. This condition may be lessened or eliminated by repositioning the mobile phone within the vehicle. This condition is not harmful to the radio. If your radio performance does not satisfactorily improve from repositioning the mobile phone, it is recommended that the volume be turned down or off during mobile phone operation when not using the Uconnect system.

## REGULATORY AND SAFETY INFORMATION

### US/CANADA

#### Exposure to Radio Frequency Radiation

The radiated output power of the internal wireless radio is far below the FCC and IC radio frequency exposure limits. Nevertheless, the wireless radio will be used in such a manner that the radio is 8 inches (20 cm) or further from the human body.

The internal wireless radio operates within guidelines found in radio frequency safety standards and recommendations, which reflect the consensus of the scientific community.

The radio manufacturer believes the internal wireless radio is safe for use by consumers. The level of energy emitted is far less than the electromagnetic energy emitted by wireless devices such as mobile phones. However, the use of wireless radios may be restricted in some situations or environments, such as aboard airplanes. If you are unsure of restrictions, you are encouraged to ask for authorization before turning on the wireless radio → page 318.



# SAFETY

## SAFETY FEATURES

### ANTI-LOCK BRAKE SYSTEM (ABS)

The ABS provides increased vehicle stability and brake performance under most braking conditions. The system automatically prevents wheel lock, and enhances vehicle control during braking.

The ABS performs a self-check cycle to ensure that the ABS is working properly each time the vehicle is started and driven. During this self-check, you may hear a slight clicking sound as well as some related motor noises.

The ABS is activated during braking when the system detects one or more wheels are beginning to lock. Road conditions such as ice, snow, gravel, bumps, railroad tracks, loose debris, or panic stops may increase the likelihood of the ABS activating.

You also may experience the following normal characteristics when the ABS activates:

- ABS motor noise or clicking sounds (you may continue to hear for a short time after the stop)
- Brake pedal pulsations
- A slight drop of the brake pedal at the end of the stop

The ABS is designed to function with the Original Equipment Manufacturer (OEM) tires. Modification may result in degraded ABS performance.

#### WARNING!

- The ABS contains sophisticated electronic equipment that may be susceptible to interference caused by improperly installed or high output radio transmitting equipment. This interference can cause possible loss of anti-lock braking capability. Installation of such equipment should be performed by qualified professionals.

*(Continued)*

#### WARNING!

- Pumping of the Anti-Lock Brakes will diminish their effectiveness and may lead to a collision. Pumping makes the stopping distance longer. Just press firmly on your brake pedal when you need to slow down or stop.
- The ABS cannot prevent the natural laws of physics from acting on the vehicle, nor can it increase braking or steering efficiency beyond that afforded by the condition of the vehicle brakes and tires or the traction afforded.
- The ABS cannot prevent collisions, including those resulting from excessive speed in turns, following another vehicle too closely, or hydroplaning.
- The capabilities of an ABS equipped vehicle must never be exploited in a reckless or dangerous manner that could jeopardize the user's safety or the safety of others.

## Anti-Lock Brake System (ABS) Warning Light

The yellow ABS Warning Light will turn on when the ignition is placed in the ON/RUN mode and may stay on for as long as four seconds.

If the ABS Warning Light remains on or comes on while driving, it indicates that the anti-lock portion of the brake system is not functioning and that service is required. However, the conventional brake system will continue to operate normally if the ABS Warning Light is on.

If the ABS Warning Light is on, the brake system should be serviced as soon as possible to restore the benefits of Anti-Lock Brakes. If the ABS Warning Light does not come on when the ignition is placed in the ON/RUN mode, have the light repaired as soon as possible.

## ELECTRONIC BRAKE CONTROL (EBC) SYSTEM

Your vehicle is equipped with an advanced Electronic Brake Control (EBC) system. This system includes Anti-Lock Brake System (ABS), Brake Assist System (BAS), Electronic Brake Force Distribution (EBD), Electronic Roll Mitigation (ERM), Electronic Stability Control (ESC), Hill Start Assist (HSA), and Traction Control System (TCS).

These systems work together to enhance both vehicle stability and control in various driving conditions.

Your vehicle may also be equipped with Ready Alert Braking (RAB) and Rain Brake Support (RBS).

### Brake Assist System (BAS)

The BAS is designed to optimize the vehicle's braking capability during emergency braking maneuvers. The system detects an emergency braking situation by sensing the rate and amount of brake application and then applies optimum pressure to the brakes. This can help reduce braking distances. The BAS complements the Anti-Lock Brake System (ABS). Applying the brakes very quickly results in the best BAS assistance. To receive the benefit of the system, you must apply continuous braking pressure during the stopping sequence (do not "pump" the brakes). Do not reduce brake pedal pressure unless braking is no longer desired. Once the brake pedal is released, the BAS is deactivated.

### WARNING!

The Brake Assist System (BAS) cannot prevent the natural laws of physics from acting on the vehicle, nor can it increase the traction afforded by prevailing road conditions. BAS cannot prevent collisions, including those resulting from excessive speed in turns, driving on very slippery surfaces, or hydroplaning. The capabilities of a BAS-equipped vehicle must never be exploited in a reckless or dangerous manner, which could jeopardize the user's safety or the safety of others.

### Brake System Warning Light

The red Brake System Warning Light will turn on when the ignition is placed in the ON/RUN mode and may stay on for as long as four seconds.

If the Brake System Warning Light remains on or comes on while driving, it indicates that the brake system is not functioning properly and that immediate service is required. If the Brake System Warning Light does not come on when the ignition is placed in the ON/RUN mode, have the light repaired as soon as possible.

## Electronic Brake Force Distribution (EBD)

EBD manages the distribution of the braking torque between the front and rear axles by limiting braking pressure to the rear axle. This is done to prevent overslip of the rear wheels to avoid vehicle instability, and to prevent the rear axle from entering the Anti-Lock Brake System (ABS) before the front axle.

## Electronic Roll Mitigation (ERM)

ERM anticipates the potential for wheel lift by monitoring the driver's steering wheel input and the speed of the vehicle. When ERM determines that the rate of change of the steering wheel angle and vehicle's speed are sufficient to potentially cause wheel lift, it then applies the appropriate brake and may also reduce engine power to lessen the chance that wheel lift will occur. ERM can only reduce the chance of wheel lift occurring during severe or evasive driving maneuvers; it cannot prevent wheel lift due to other factors, such as road conditions, leaving the roadway, or striking objects or other vehicles.

### NOTE:

ERM is disabled any time the ESC is in "Full Off" mode (if equipped). For a complete explanation of the available ESC modes, see ⇨ page 181.

### WARNING!

Many factors, such as vehicle loading, road conditions and driving conditions, influence the chance that wheel lift or rollover may occur. ERM cannot prevent all wheel lift or rollovers, especially those that involve leaving the roadway or striking objects or other vehicles. The capabilities of an ERM-equipped vehicle must never be exploited in a reckless or dangerous manner which could jeopardize the user's safety or the safety of others.

## Electronic Stability Control (ESC)

ESC enhances directional control and stability of the vehicle under various driving conditions. ESC corrects for oversteering or understeering of the vehicle by applying the brake of the appropriate wheel(s) to counteract these conditions. Engine power may also be reduced to help the vehicle maintain the desired path.

- Oversteer – when the vehicle is turning more than appropriate for the steering wheel position.
- Understeer – when the vehicle is turning less than appropriate for the steering wheel position.

ESC uses sensors in the vehicle to determine the vehicle path intended by the driver and compares it to the actual path of the vehicle. When the actual path does not match the intended path, ESC applies the brake of the appropriate wheel to assist in counteracting the oversteer or understeer condition.

The ESC Activation/Malfunction Indicator Light located in the instrument cluster will start to flash as soon as the ESC system becomes active. The ESC Activation/Malfunction Indicator Light also flashes when the TCS is active. If the ESC Activation/Malfunction Indicator Light begins to flash during acceleration, ease up on the accelerator and apply as little throttle as possible. Be sure to adapt your speed and driving to the prevailing road conditions.

**WARNING!**

- Electronic Stability Control (ESC) cannot prevent the natural laws of physics from acting on the vehicle, nor can it increase the traction afforded by prevailing road conditions. ESC cannot prevent accidents, including those resulting from excessive speed in turns, driving on very slippery surfaces, or hydroplaning. ESC also cannot prevent accidents resulting from loss of vehicle control due to inappropriate driver input for the conditions. Only a safe, attentive, and skillful driver can prevent accidents. The capabilities of an ESC equipped vehicle must never be exploited in a reckless or dangerous manner which could jeopardize the user's safety or the safety of others.

*(Continued)***WARNING!**

- Vehicle modifications, or failure to properly maintain your vehicle, may change the handling characteristics of your vehicle, and may negatively affect the performance of the ESC system. Changes to the steering system, suspension, braking system, tire type and size or wheel size may adversely affect ESC performance. Improperly inflated and unevenly worn tires may also degrade ESC performance. Any vehicle modification or poor vehicle maintenance that reduces the effectiveness of the ESC system can increase the risk of loss of vehicle control, vehicle rollover, personal injury and death.

**ESC Operating Modes**

Depending upon model and mode of operation, the ESC system may have multiple operating modes.

**ESC On**

This is the normal operating mode for the ESC. Whenever the vehicle is started, the ESC system will be in this mode. This mode should be used for most driving conditions. Alternate ESC modes should only be used for specific reasons as noted in the following paragraphs.

**Partial Off**

This mode may be useful if the vehicle becomes stuck. This mode may modify TCS and ESC thresholds for activation, which allows for more wheel spin than normally allowed.

To enter the "Partial Off" mode, momentarily push the ESC OFF switch and the ESC OFF Indicator Light will illuminate. To turn the ESC on again, momentarily push the ESC OFF switch and the ESC OFF Indicator Light will turn off.

**WARNING!**

When in "Partial Off" mode, the TCS functionality of ESC (except for the limited slip feature described in the TCS section) has been disabled and the ESC OFF Indicator Light will be illuminated. When in "Partial Off" mode, the engine power reduction feature of TCS is disabled, and the enhanced vehicle stability offered by the ESC system is reduced.

**NOTE:**

- For vehicles with multiple partial ESC modes, the push and release of the switch will toggle the ESC modes. Multiple attempts may be required to return to "ESC On" mode.
- Trailer Sway Control (TSC) is disabled when the ESC system is in the "Partial Off" mode.
- If Equipped — "ESC Sport" and "ESC Track" are ESC "Partial Off" mode(s).

**Full Off – If Equipped**

This mode is intended for off-highway or off-road use only and should not be used on any public roadways. In this mode, TCS and ESC features are turned off. To enter the "Full Off" mode, push and hold the ESC OFF switch for five seconds while the vehicle is stopped with the engine running. After five seconds, a chime will sound, the ESC OFF Indicator Light will illuminate, and the "ESC OFF" message will display in the instrument cluster. To turn ESC on again, momentarily push the ESC OFF switch.

**WARNING!**

- In the ESC "Full Off" mode, the engine torque reduction and stability features are disabled. Therefore, enhanced vehicle stability offered by the ESC system is unavailable. In an emergency evasive maneuver, the ESC system will not engage to assist in maintaining stability. ESC "Full Off" mode is intended for off-highway or off-road use only.
- The Electronic Stability Control (ESC) cannot prevent the natural laws of physics from acting on the vehicle, nor can it increase the traction afforded by prevailing road conditions. ESC cannot prevent all accidents, including those resulting from excessive speed in turns, driving on very slippery surfaces, or hydroplaning. ESC also cannot prevent collisions.

**ESC Activation/Malfunction Indicator Light And ESC OFF Indicator Light**

The ESC Activation/Malfunction Indicator Light in the instrument cluster will come on when the ignition is placed in the ON mode. It should go out with the engine running. If the ESC Activation/Malfunction Indicator Light comes on continuously with the engine running, a malfunction has been detected in the ESC system. If this light remains on after several ignition cycles, and the vehicle has been driven several miles (kilometers) at speeds greater than 30 mph (48 km/h), see an authorized dealer as soon as possible to have the problem diagnosed and corrected.

The ESC Activation/Malfunction Indicator Light starts to flash as soon as the tires lose traction and the ESC system becomes active. The ESC Activation/Malfunction Indicator Light also flashes when TCS is active. If the ESC Activation/Malfunction Indicator Light begins to flash during acceleration, ease up on the accelerator and apply as little throttle as possible. Be sure to adapt your speed and driving to the prevailing road conditions.



The ESC OFF Indicator Light indicates that the Electronic Stability Control (ESC) is in a reduced mode.

#### NOTE:

- The ESC Activation/Malfunction Indicator Light and the ESC OFF Indicator Light come on momentarily each time the ignition is placed in the ON position.
- Each time the ignition is placed in the ON position, the ESC system will be on even if it was turned off previously.
- The ESC system will make buzzing or clicking sounds when it is active. This is normal; the sounds will stop when ESC becomes inactive following the maneuver that caused the ESC activation.

#### Hill Start Assist (HSA)

HSA is designed to mitigate roll back from a complete stop while on an incline. If the driver releases the brake while stopped on an incline, HSA will continue to hold the brake pressure for a short period. If the driver does not apply the throttle before this time expires, the system will release brake pressure and the vehicle will roll down the hill as normal.

The following conditions must be met in order for HSA to activate:

- The feature must be enabled.
- The vehicle must be stopped.
- The parking brake must be off.
- The driver door must be closed.
- The vehicle must be on a sufficient grade.
- The gear selection must match vehicle uphill direction (i.e., vehicle facing uphill is in forward gear; vehicle backing uphill is in REVERSE gear).
- HSA will work in REVERSE gear and all forward gears. The system will not activate if the transmission is in PARK or NEUTRAL. For vehicles equipped with a manual transmission, if the clutch is pressed, HSA will remain active.

#### WARNING!

There may be situations where the Hill Start Assist (HSA) will not activate and slight rolling may occur, such as on minor hills or with a loaded vehicle, or while pulling a trailer. HSA is not a substitute for active driving involvement. It is always the driver's responsibility to be attentive to distance to other vehicles, people, and objects, and most importantly brake operation to ensure safe operation of the vehicle under all road conditions. Your complete attention is always required while driving to maintain safe control of your vehicle. Failure to follow these warnings can result in a collision or serious personal injury.

#### Disabling And Enabling HSA

This feature can be turned on or turned off. To change the current setting, proceed as follows:

If disabling HSA using Uconnect Settings, see [page 120](#).

## Towing With HSA

HSA will also provide assistance to mitigate roll back while towing a trailer.

### WARNING!

- If you use a trailer brake controller with your trailer, the trailer brakes may be activated and deactivated with the brake switch. If so, there may not be enough brake pressure to hold both the vehicle and the trailer on a hill when the brake pedal is released. In order to avoid rolling down an incline while resuming acceleration, manually activate the trailer brake or apply more vehicle brake pressure prior to releasing the brake pedal.
- HSA is not a parking brake. Always apply the parking brake fully when exiting your vehicle. Also, be certain to place the transmission in PARK.
- Failure to follow these warnings can result in a collision or serious personal injury.

## Rain Brake Support (RBS)

RBS may improve braking performance in wet conditions. It will periodically apply a small amount of brake pressure to remove any water buildup on the front brake rotors. It functions when the windshield wipers are in LO or HI speed. When RBS is active, there is no notification to the driver and no driver interaction is required.

## Ready Alert Braking (RAB)

RAB may reduce the time required to reach full braking during emergency braking situations. It anticipates when an emergency braking situation may occur by monitoring how fast the throttle is released by the driver. The Electronic Brake Controller (EBC) will prepare the brake system for a panic stop.

## Traction Control System (TCS)

The TCS monitors the amount of wheel spin of each of the driven wheels. If wheel spin is detected, the TCS may apply brake pressure to the spinning wheel(s) and/or reduce engine power to provide enhanced acceleration and stability. A feature of the TCS, Brake Limited Differential (BLD) functions similarly to a limited slip differential and controls the wheel spin across a driven axle. If one wheel on a driven axle is spinning faster than the other, the system will apply the brake of the spinning wheel.

This will allow more engine power to be applied to the wheel that is not spinning. BLD may remain enabled even if TCS and ESC are in reduced modes.

## AUXILIARY DRIVING SYSTEMS

### BLIND SPOT MONITORING (BSM) — IF EQUIPPED

BSM uses two radar sensors, located inside the rear fascia/bumper, to detect highway licensable vehicles (automobiles, trucks, motorcycles, etc.) that enter the blind spot zones from the rear/front side of the vehicle.

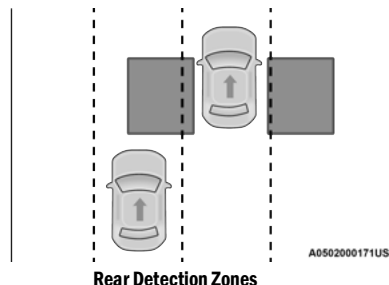

When the vehicle is started, the BSM Warning Light will momentarily illuminate in both outside rearview mirrors to let the driver know that the system is operational.

#### Automatic Transmission Vehicles

The BSM system sensors operate when the vehicle is in any forward gear.

#### Manual Transmission Vehicles

The BSM system sensors operate when the vehicle is in any gear.

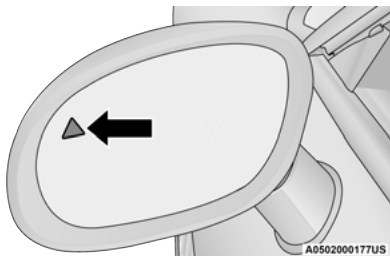

**BSM Warning Light**

The BSM detection zone covers approximately one lane width on both sides of the vehicle 12 ft (3.8 m). The zone length starts at the outside rearview mirror and extends approximately 10 ft (3 m) beyond the rear fascia/bumper of the vehicle.

The BSM system monitors the detection zones on both sides of the vehicle when the vehicle speed reaches approximately 6 mph (10 km/h) or higher and will alert the driver of vehicles in these areas.

#### NOTE:

- The BSM system DOES NOT alert the driver about rapidly approaching vehicles that are outside the detection zones.
- The BSM system detection zone DOES NOT change if your vehicle is towing a trailer. Therefore, visually verify the adjacent lane is clear for both your vehicle and trailer before making a lane change. If the trailer or other object (i.e., bicycle, sports equipment) extends beyond the side of your vehicle, this may result in the BSM Warning Light remaining illuminated the entire time the vehicle is in a forward gear.
- The BSM system may experience dropouts (blinking on and off) of the side mirror warning indicator lamps when a motorcycle or any small object remains at the side of the vehicle for extended periods of time (more than a couple of seconds).

The area on the rear fascia/bumper where the radar sensors are located must remain free of snow, ice and dirt/road contamination so that the BSM system can function properly. Do not block the area of the rear fascia/bumper where the radar sensors are located with foreign objects (bumper stickers, bicycle racks, etc.).

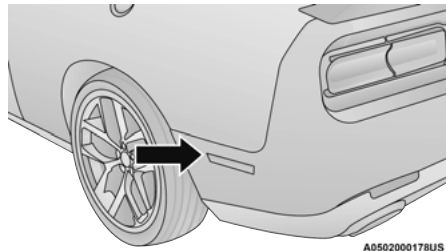

**Sensor Location**



The BSM system notifies the driver of objects in the detection zones by illuminating the BSM warning light located in the outside mirrors in addition to sounding an audible (chime) alert and reducing the radio volume → page 189.

The BSM system monitors the detection zone from three different entry points (side, rear, front) while driving to see if an alert is necessary. The BSM system will issue an alert during these types of zone entries.

### Entering From The Side

Vehicles that move into your adjacent lanes from either side of the vehicle.

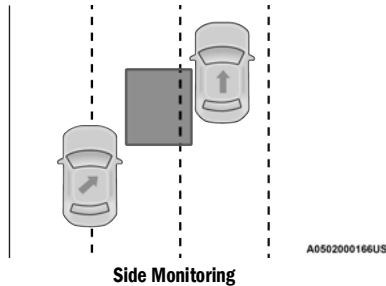

### Entering From The Rear

Vehicles that come up from behind your vehicle on either side and enter the rear detection zone with a relative speed of less than 31 mph (50 km/h).

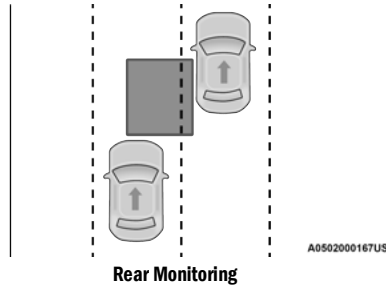

### Overtaking Traffic

If you pass another vehicle slowly (with a relative speed of less than 15 mph (24 km/h)) and the vehicle remains in the blind spot for approximately 1.5 seconds, the warning light will be illuminated. If the difference in speed between the two vehicles is greater than 15 mph (24 km/h), the warning light will not illuminate.

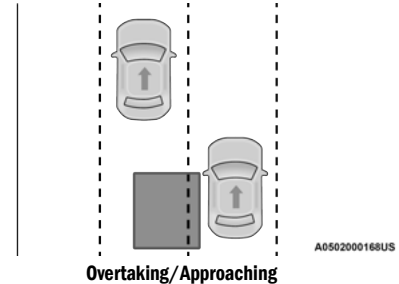

The BSM system is designed not to issue an alert on stationary objects such as guardrails, posts, walls, foliage, berms, etc. However, occasionally the system may alert on such objects. This is normal operation and your vehicle does not require service.

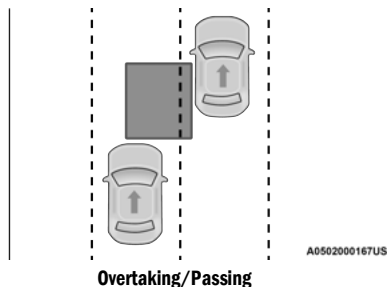

The BSM system will not alert you of objects that are traveling in the opposite direction of the vehicle in adjacent lanes → page 318.

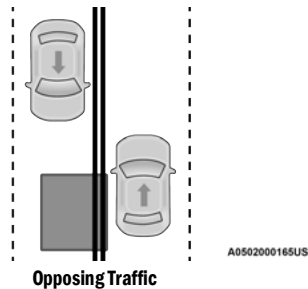

A0502000165US

### WARNING!

The Blind Spot Monitoring system is only an aid to help detect objects in the blind spot zones. The BSM system is not designed to detect pedestrians, bicyclists, or animals. Even if your vehicle is equipped with the BSM system, always check your vehicle's mirrors, glance over your shoulder, and use your turn signal before changing lanes. Failure to do so can result in serious injury or death.

## Rear Cross Path — If Equipped

RCP is intended to aid the driver when backing out of parking spaces where their vision of oncoming vehicles may be blocked. Proceed slowly and cautiously out of the parking space until the rear end of the vehicle is exposed. The RCP system will then have a clear view of the cross traffic and, if an oncoming vehicle is detected, alert the driver.

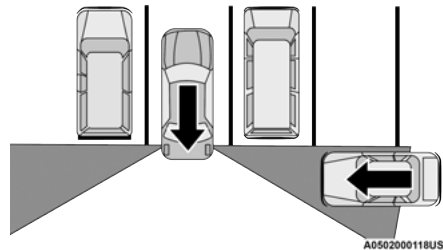

A0502000118US

RCP monitors the rear detection zones on both sides of the vehicle, for objects that are moving toward the side of the vehicle with a minimum speed of approximately 3 mph (5 km/h), to objects moving a maximum of approximately 20 mph (32 km/h), such as in parking lot situations.

When RCP is on and the vehicle is in REVERSE, the driver is alerted using both the visual and audible alerts, including reducing the radio volume so that the alert can be better heard.

**NOTE:**

In a parking lot situation, oncoming vehicles can be blocked by vehicles parked on either side. If the sensors are blocked by other structures or vehicles, the system will not be able to alert the driver.

**WARNING!**

Rear Cross Path Detection (RCP) is not a backup aid system. It is intended to be used to help a driver detect an oncoming vehicle in a parking lot situation. Drivers must be careful when backing up, even when using RCP. Always check carefully behind your vehicle, look behind you, and be sure to check for pedestrians, animals, other vehicles, obstructions, and blind spots before backing up. Failure to do so can result in serious injury or death.

## Modes Of Operation

Blind Spot has three selectable modes of operation that are available in the Uconnect system.

### Blind Spot Alert Lights Only

When operating in Blind Spot Alert mode, the BSM system will provide a visual alert in the appropriate side view mirror based on a detected object. However, when the system is operating in RCP mode, the system will respond with both visual and audible alerts when a detected object is present. Whenever an audible alert is requested, the radio volume is reduced so that the alert can be better heard.

### Blind Spot Alert Lights/Chime

When operating in Blind Spot Alert Lights/Chime mode, the BSM system will provide a visual alert in the appropriate side view mirror based on a detected object. If the turn signal is then activated, and it corresponds to an alert present on that side of the vehicle, an audible chime will also be sounded. Whenever a turn signal and detected object are present on the same side at the same time, both the visual and audio alerts will be issued. In addition to the audible alert the radio (if on) volume will be reduced so that the alert can be better heard.

When the system is in RCP, the system shall respond with both visual and audible alerts when a detected object is present. Whenever an audible alert is requested, the radio volume is reduced so that the alert can be better heard.

### Blind Spot Alert Off

When the BSM system is turned off there will be no visual or audible alerts from either the BSM or RCP systems.

**NOTE:**

The BSM system will store the current operating mode when the vehicle is shut off. Each time the vehicle is started the previously stored mode will be recalled and used.

## FORWARD COLLISION WARNING (FCW) OPERATION — IF EQUIPPED

FCW with Mitigation provides the driver with audible warnings and visual warnings (within the instrument cluster display) to warn the driver when it detects a potential frontal collision. The warnings are intended to provide the driver with enough time to react, avoid or mitigate the potential collision.

**NOTE:**

FCW monitors the information from the forward looking sensors as well as the Electronic Stability Control (ESC) system, to calculate the probability of a forward collision. When the system determines that a forward collision is probable, the driver will be provided with audible and visual warnings.

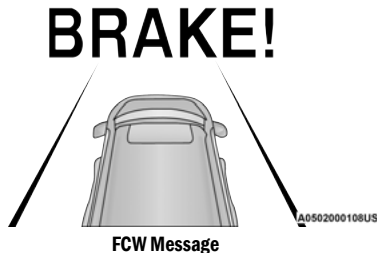

When the system determines a collision with the vehicle in front of you is no longer probable, the warning message will be deactivated → page 318.

**NOTE:**

- The minimum speed for FCW activation is 5 mph (10 km/h).
- The FCW alerts may be triggered on objects other than vehicles such as guardrails or sign posts based on the course prediction. This is expected and is a part of normal FCW activation and functionality.
- The FCW system is intended for on-road use only. If the vehicle is taken off-road, the FCW system should be deactivated to prevent unnecessary warnings to the surroundings.

**WARNING!**

Forward Collision Warning (FCW) is not intended to avoid a collision on its own, nor can FCW detect every type of potential collision. The driver has the responsibility to avoid a collision by controlling the vehicle via braking and steering. Failure to follow this warning could lead to serious injury or death.

**Turning FCW On Or Off****NOTE:**

The default status of FCW is on; this allows the system to warn you of a possible collision with the vehicle in front of you.

The Forward Collision activation/deactivation is located in "Uconnect Settings" under "Safety And Driving Assistance". Forward Collision can be checked or unchecked.

When FCW is selected off, there will be an "FCW OFF" icon that appears in the instrument cluster display.

Changing the FCW status to off prevents the system from warning you of a possible collision with the vehicle in front of you.

**NOTE:**

The FCW system's default state is on. The FCW system state is kept in memory from one ignition cycle to the next. If the system is turned off, it will remain off when the vehicle is restarted.

**Changing FCW Status**

The FCW Sensitivity settings are programmable through the Uconnect system → page 120.

The default status of FCW is the "Far" setting in the "On" setting. This allows the system to warn you of a possible collision with the vehicle in front of you when you are farther away and it applies limited braking. This gives you the most reaction time to avoid a possible collision.

Changing the FCW status to the “Near” setting, allows the system to warn you of a possible collision with the vehicle in front of you when you are much closer. This setting provides less reaction time than the “Far” setting, which allows for a more dynamic driving experience.

#### NOTE:

- The system will retain the last setting selected by the driver after ignition shut down.
- FCW may not react to irrelevant objects such as overhead objects, ground reflections, objects not in the path of the vehicle, stationary objects that are far away, oncoming traffic, or leading vehicles with the same or higher rate of speed.
- FCW will be disabled like ACC, with the unavailable screens.

### Service FCW Warning

If the system turns off, and the instrument cluster display reads:

- ACC/FCW Unavailable Service Required
- Cruise/FCW Unavailable Service Required

This indicates there is an internal system fault. Although the vehicle is still drivable under normal conditions, have the system checked by an authorized dealer.

## TIRE PRESSURE MONITORING SYSTEM (TPMS)

The Tire Pressure Monitoring System (TPMS) will warn the driver of a low tire pressure based on the vehicle recommended cold placard pressure.

The tire pressure will vary with temperature by about 1 psi (7 kPa) for every 12 °F (6.5 °C). This means that when the outside temperature decreases, the tire pressure will decrease. Tire pressure should always be set based on cold inflation tire pressure. This is defined as the tire pressure after the vehicle has not been driven for at least three hours, or driven less than 1 mile (1.6 km) after a three hour period. The cold tire inflation pressure must not exceed the maximum inflation pressure molded into the tire sidewall. The tire pressure will also increase as the vehicle is driven — this is normal and there should be no adjustment for this increased pressure.

See [page 285](#) on how to properly inflate the vehicle's tires.

The TPMS will warn the driver of a low tire pressure if the tire pressure falls below the low-pressure warning limit for any reason, including low temperature effects and natural pressure loss through the tire.

The TPMS will continue to warn the driver of low tire pressure as long as the condition exists, and will not turn off until the tire pressure is at or above the recommended cold placard pressure. Once the low tire pressure warning (TPMS Warning Light) illuminates, you must increase the tire pressure to the recommended cold placard pressure in order for the TPMS Warning Light to turn off. The system will automatically update and the TPMS Warning Light will turn off once the system receives the updated tire pressures. The vehicle may need to be driven for up to 20 minutes above 15 mph (24 km/h) in order for the TPMS to receive this information.

#### NOTE:

When filling warm tires, the tire pressure may need to be increased up to an additional 4 psi (28 kPa) above the recommended cold placard pressure in order to turn the TPMS Warning Light off.

For example, your vehicle may have a recommended cold (parked for more than three hours) placard pressure of 30 psi (207 kPa). If the ambient temperature is 68 °F (20 °C) and the measured tire pressure is 27 psi (186 kPa), a temperature drop to 20 °F (-7 °C) will decrease the tire pressure to approximately 23 psi (158 kPa).

This tire pressure is sufficiently low enough to turn on the TPMS Warning Light. Driving the vehicle may cause the tire pressure to rise to approximately 27 psi (186 kPa), but the TPMS Warning Light will still be on. In this situation, the TPMS Warning Light will turn off only after the tires are inflated to the vehicle's recommended cold placard pressure value → page 318.

#### CAUTION!

- The TPMS has been optimized for the original equipment tires and wheels. TPMS pressures and warning have been established for the tire size equipped on your vehicle. Undesirable system operation or sensor damage may result when using replacement equipment that is not of the same size, type, and/or style. The TPMS sensor is not designed for use on aftermarket wheels and may contribute to a poor overall system performance or sensor damage. Customers are encouraged to use OEM wheels to ensure proper TPMS feature operation.
- Using aftermarket tire sealants may cause the Tire Pressure Monitoring System (TPMS) sensor to become inoperable. After using an aftermarket tire sealant it is recommended that you take your vehicle to an authorized dealer to have your sensor function checked.

(Continued)

#### CAUTION!

- After inspecting or adjusting the tire pressure always reinstall the valve stem cap. This will prevent moisture and dirt from entering the valve stem, which could damage the TPMS sensor.

#### NOTE:

- The TPMS is not intended to replace normal tire care and maintenance or to provide warning of a tire failure or condition.
- The TPMS should not be used as a tire pressure gauge while adjusting your tire pressure, unless your vehicle is equipped with a Tire Fill Alert (TFA) system.
- Driving on a significantly underinflated tire causes the tire to overheat and can lead to tire failure. Underinflation also reduces fuel efficiency and tire tread life, and may affect the vehicle's handling and stopping ability.
- The TPMS is not a substitute for proper tire maintenance, and it is the driver's responsibility to maintain correct tire pressure using an accurate tire pressure gauge, even if underinflation has not reached the level to trigger illumination of the TPMS Warning Light.

- Seasonal temperature changes will affect tire pressure, and the TPMS will monitor the actual tire pressure in the tire.

#### Premium System

The Tire Pressure Monitoring System (TPMS) uses wireless technology with wheel rim mounted electronic sensors to monitor tire pressure levels. Sensors, mounted to each wheel as part of the valve stem, transmit tire pressure readings to the receiver module.

#### NOTE:

It is particularly important for you to check the tire pressure in all of the tires on your vehicle monthly and to maintain the proper pressure.

The TPMS consists of the following components:

- Receiver module
- Four Tire Pressure Monitoring System sensors
- Various Tire Pressure Monitoring System messages, which display in the instrument cluster
- Tire Pressure Monitoring System Warning Light

## Tire Pressure Monitoring System Low Pressure Warnings



The TPMS Warning Light will illuminate in the instrument cluster and a chime will sound when tire pressure is low in one or more of the four active road tires. In addition, the instrument cluster will display an "Inflate to XX" message and a graphic showing the pressure values of each tire with the low tire pressure values shown in a different color.



**Tire Pressure Monitoring System Display**

Should this occur, you should stop as soon as possible and inflate the tires with a low pressure condition (those shown in a different color in the instrument cluster graphic) to the vehicle's recommended cold placard pressure inflation value as shown in the "Inflate to XX" message.

Once the system receives the updated tire pressures, the system will automatically update, the graphic display in the instrument cluster will change color back to the original color, and the TPMS Warning Light will turn off. The vehicle may need to be driven for up to 20 minutes above 15 mph (24 km/h) in order for the TPMS to receive this information.

### NOTE:

When filling warm tires, the tire pressure may need to be increased up to an additional 4 psi (28 kPa) above the recommended cold placard pressure in order to turn the TPMS Warning Light off.

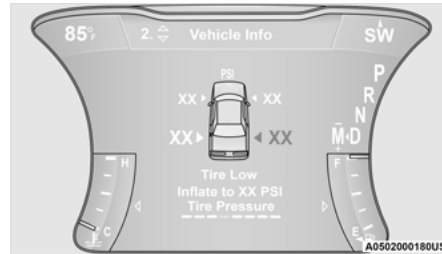

**Low Tire Pressure Monitoring System Display**

## Service Tire Pressure Monitoring System Warning

If a system fault is detected, the Tire Pressure Monitoring System (TPMS) Warning Light will flash on and off for 75 seconds and then remain on solid. The system fault will also sound a chime. In addition, the instrument cluster will display a "Service Tire Pressure System" message for a minimum of five seconds and then display dashes (- -) in place of the pressure value to indicate which sensor is not being received.

If the ignition switch is cycled, this sequence will repeat, providing the system fault still exists. If the system fault no longer exists, the TPMS Warning Light will no longer flash, and the "Service Tire Pressure System" message will no longer display, and a pressure value will display in place of the dashes. A system fault can occur due to any of the following:

- Signal interference due to electronic devices or driving next to facilities emitting the same radio frequencies as the TPMS sensors
- Accumulation of snow or ice around the wheels or wheel housings
- Using tire chains on the vehicle
- Using wheels/tires not equipped with TPMS sensors

### Vehicles With Compact Spare

1. The compact spare tire or non-matching full size does not have a Tire Pressure Monitoring System sensor. Therefore, the TPMS will not monitor the pressure in the compact or non-matching full size spare tire.
2. If you install the compact or non-matching full size spare tire in place of a road tire that has a pressure below the low-pressure warning limit, upon the next ignition key cycle, the TPMS Warning Light will remain on and a chime will sound. In addition, the graphic in the instrument cluster will still display a different color pressure value and an "Inflate to XX" message.
3. After driving the vehicle for up to 20 minutes above 15 mph (24 km/h), the TPMS Warning Light will flash on and off for 75 seconds and then remain on solid. In addition, the instrument cluster will display a "Service Tire Pressure System" message for five seconds and then display dashes (- -) in place of the pressure value.
4. For each subsequent ignition key cycle, a chime will sound, the TPMS Warning Light will flash on and off for 75 seconds and then remain on solid, and the instrument cluster will display a "Service Tire Pressure System" message for five seconds and then display dashes (- -) in place of the pressure value.

5. Once you repair or replace the original road tire and reinstall it on the vehicle in place of the compact spare or non-matching full size, the TPMS will update automatically. In addition, the TPMS Warning Light will turn off and the graphic in the instrument cluster will display a new pressure value instead of dashes (- -), as long as no tire pressure is below the low-pressure warning limit in any of the four active road tires. The vehicle may need to be driven for up to 20 minutes above 15 mph (24 km/h) in order for the TPMS to receive this information.

### TPMS Deactivation — If Equipped

The Tire Pressure Monitoring System (TPMS) can be deactivated if replacing all four wheel and tire assemblies (road tires) with wheel and tire assemblies that do not have TPMS sensors, such as when installing winter wheel and tire assemblies on your vehicle.

To deactivate the TPMS, first replace all four wheel and tire assemblies (road tires) with tires not equipped with Tire Pressure Monitoring System (TPMS) sensors. Then, drive the vehicle for 20 minutes above 15 mph (24 km/h). The TPMS will chime, the TPMS Warning Light will flash on and off for 75 seconds and then remain on. The instrument cluster will display the "Service Tire Pressure System" message and then display dashes (-) in place of the pressure values.

Beginning with the next ignition cycle, the TPMS will no longer chime or display the "Service Tire Pressure System" message in the instrument cluster but dashes (-) will remain in place of the pressure values.

To reactivate the TPMS, replace all four wheel and tire assemblies (road tires) with tires equipped with TPMS sensors. Then, drive the vehicle for up to 20 minutes above 15 mph (24 km/h). The TPMS will chime, the TPMS Warning Light will flash on and off for 75 seconds and then turn off. The instrument cluster will display the "Service Tire Pressure System" message and then display pressure values in place of the dashes. On the next ignition cycle the "Service Tire Pressure System" message will no longer be displayed as long as no system fault exists.

## OCCUPANT RESTRAINT SYSTEMS

Some of the most important safety features in your vehicle are the restraint systems:

### OCCUPANT RESTRAINT SYSTEMS FEATURES

- Seat Belt Systems
- Supplemental Restraint Systems (SRS) Air Bags
- Child Restraints



Some of the safety features described in this section may be standard equipment on some models, or may be optional equipment on others. If you are not sure, ask an authorized dealer.

## IMPORTANT SAFETY PRECAUTIONS

Please pay close attention to the information in this section. It tells you how to use your restraint system properly, to keep you and your passengers as safe as possible.

Here are some simple steps you can take to minimize the risk of harm from a deploying air bag:

1. Children 12 years old and under should always ride buckled up in the rear seat of a vehicle with a rear seat.  
If your vehicle is not equipped with a rear seat, FCA US LLC recommends that you do not allow children 12 years old and under to ride in your vehicle.
2. A child who is not big enough to wear the vehicle seat belt properly must be secured in the appropriate child restraint or belt-positioning booster seat in a rear seating position ↪ page 211.
3. If a child from 2 to 12 years old (not in a rear-facing child restraint) must ride in the front passenger seat, move the seat as far back as possible and use the proper child restraint ↪ page 211.

4. Never allow children to slide the shoulder belt behind them or under their arm.
5. You should read the instructions provided with your child restraint to make sure that you are using it properly.
6. All occupants should always wear their lap and shoulder belts properly.
7. The driver and front passenger seats should be moved back as far as practical to allow the front air bags room to inflate.
8. Do not lean against the door or window. If your vehicle has side air bags, and deployment occurs, the side air bags will inflate forcefully into the space between occupants and the door and occupants could be injured.
9. If the air bag system in this vehicle needs to be modified to accommodate a disabled person, see ↪ page 315 for customer service contact information.

### WARNING!

- Never place a rear-facing child restraint in front of an air bag. A deploying passenger front air bag can cause death or serious injury to a child 12 years or younger, including a child in a rear-facing child restraint.

(Continued)

### WARNING!

- Never install a rear-facing child restraint in the front seat of a vehicle. Only use a rear-facing child restraint in the rear seat. If the vehicle does not have a rear seat, do not transport a rear-facing child restraint in that vehicle.

## SEAT BELT SYSTEMS

Buckle up even though you are an excellent driver, even on short trips. Someone on the road may be a poor driver and could cause a collision that includes you. This can happen far away from home or on your own street.

Research has shown that seat belts save lives, and they can reduce the seriousness of injuries in a collision. Some of the worst injuries happen when people are thrown from the vehicle. Seat belts reduce the possibility of ejection and the risk of injury caused by striking the inside of the vehicle. Everyone in a motor vehicle should be belted at all times.

## Vehicles Without Passenger Seating Installed

If your vehicle does not have a factory installed front passenger seat and/or rear passenger seats, the features described in this section may not be available in your vehicle.

This vehicle has been designed to maximize total performance. The passenger seats may be deleted, which may affect the NVH (Noise, Vibration, and Harshness) characteristics. As a result, the vehicle may be louder overall.

Furthermore, the passenger seats and seat belts systems are deleted.

### WARNING!

- If the passenger and/or rear seats have been removed, do not ride in those areas. In a collision, people riding in these areas are more likely to be seriously injured or killed.
- If this vehicle was not factory equipped with a passenger seat, NEVER attempt to install a passenger seat because the safety systems, including the air bags and seat belt, may not properly protect you.

*(Continued)*

### WARNING!

- It is dangerous to ride in a cargo area, inside or outside of a vehicle. In a collision, people riding in this area are more likely to be seriously injured or killed.
- Only ride in available seating positions equipped with seat belt systems. Always properly wear your seat belt. Failure to do so could result in an increased risk of serious injury or death in the event of an accident.
- Be sure everyone in your vehicle is in a seat and using a seat belt properly. Occupants, including the driver, should always wear their seat belts whether or not an air bag is also provided at their seating positions to minimize the risk of severe injury or death in the event of a crash.
- All occupants, including the driver, should not operate a vehicle or sit in a vehicle's seat if the head restraints are not in place of their proper positions in order to minimize the risk of neck injury in the event of a crash.
- Head restraints should never be adjusted while the vehicle is in motion. Driving a vehicle with the head restraints improperly adjusted or removed could cause serious injury or death in the event of a collision.

## Enhanced Seat Belt Use Reminder System (BeltAlert)

### Driver And Passenger BeltAlert — If Equipped

 BeltAlert is a feature intended to remind the driver and outboard front seat passenger (if equipped with outboard front passenger seat BeltAlert) to buckle their seat belts. The BeltAlert feature is active whenever the ignition switch is in the START or ON/RUN position.

### Initial Indication

If the driver is unbuckled when the ignition switch is first in the START or ON/RUN position, a chime will signal for a few seconds. If the driver or outboard front seat passenger (if equipped with outboard front passenger seat BeltAlert) is unbuckled when the ignition switch is first in the START or ON/RUN position the Seat Belt Reminder Light will turn on and remain on until both outboard front seat belts are buckled. The outboard front passenger seat BeltAlert is not active when an outboard front passenger seat is unoccupied.

### BeltAlert Warning Sequence

The BeltAlert warning sequence is activated when the vehicle is moving above a specified vehicle speed range and the driver or outboard front seat passenger is unbuckled (if equipped with outboard front passenger seat BeltAlert) (the outboard front passenger seat BeltAlert is not active when the outboard front passenger seat is unoccupied). The BeltAlert warning sequence starts by blinking the Seat Belt Reminder Light and sounding an intermittent chime. Once the BeltAlert warning sequence has completed, the Seat Belt Reminder Light will remain on until the seat belts are buckled. The BeltAlert warning sequence may repeat based on vehicle speed until the driver and occupied outboard front seat passenger seat belts are buckled. The driver should instruct all occupants to buckle their seat belts.

### Change Of Status

If the driver or outboard front seat passenger (if equipped with outboard front passenger seat BeltAlert) unbuckles their seat belt while the vehicle is traveling, the BeltAlert warning sequence will begin until the seat belts are buckled again.

The outboard front passenger seat BeltAlert is not active when the outboard front passenger seat is unoccupied. BeltAlert may be triggered when an animal or other items are placed on the outboard front passenger seat or when the seat is folded flat (if equipped). It is recommended that pets be restrained in the rear seat (if equipped) in pet harnesses or pet carriers that are secured by seat belts, and cargo is properly stowed.

BeltAlert can be activated or deactivated by an authorized dealer. FCA US LLC does not recommend deactivating BeltAlert.

### NOTE:

If BeltAlert has been deactivated and the driver or outboard front seat passenger (if equipped with outboard front passenger seat BeltAlert) is unbuckled the Seat Belt Reminder Light will turn on and remain on until the driver and outboard front seat passenger seat belts are buckled.

### Lap/Shoulder Belts

All seating positions in your vehicle are equipped with lap/shoulder belts.

The seat belt webbing retractor will lock only during very sudden stops or collisions. This feature allows the shoulder part of the seat belt to move freely with you under normal conditions. However, in a collision the seat belt will lock and reduce your risk of striking the inside of the vehicle or being thrown out of the vehicle.

### WARNING!

- Relying on the air bags alone could lead to more severe injuries in a collision. The air bags work with your seat belt to restrain you properly. In some collisions, the air bags won't deploy at all. Always wear your seat belt even though you have air bags.
- In a collision, you and your passengers can suffer much greater injuries if you are not properly buckled up. You can strike the interior of your vehicle or other passengers, or you can be thrown out of the vehicle. Always be sure you and others in your vehicle are buckled up properly.
- It is dangerous to ride in a cargo area, inside or outside of a vehicle. In a collision, people riding in these areas are more likely to be seriously injured or killed.
- Do not allow people to ride in any area of your vehicle that is not equipped with seats and seat belts.

*(Continued)*

**WARNING!**

- Be sure everyone in your vehicle is in a seat and using a seat belt properly. Occupants, including the driver, should always wear their seat belts whether or not an air bag is also provided at their seating position to minimize the risk of severe injury or death in the event of a crash.
- Wearing your seat belt incorrectly could make your injuries in a collision much worse. You might suffer internal injuries, or you could even slide out of the seat belt. Follow these instructions to wear your seat belt safely and to keep your passengers safe, too.
- Two people should never be belted into a single seat belt. People belted together can crash into one another in a collision, hurting one another badly. Never use a lap/shoulder belt or a lap belt for more than one person, no matter what their size.

**WARNING!**

- A lap belt worn too high can increase the risk of injury in a collision. The seat belt forces won't be at the strong hip and pelvic bones, but across your abdomen. Always wear the lap part of your seat belt as low as possible and keep it snug.
- A twisted seat belt may not protect you properly. In a collision, it could even cut into you. Be sure the seat belt is flat against your body, without twists. If you can't straighten a seat belt in your vehicle, take it to an authorized dealer immediately and have it fixed.
- A seat belt that is buckled into the wrong buckle will not protect you properly. The lap portion could ride too high on your body, possibly causing internal injuries. Always buckle your seat belt into the buckle nearest you.
- A seat belt that is too loose will not protect you properly. In a sudden stop, you could move too far forward, increasing the possibility of injury. Wear your seat belt snugly.

*(Continued)*

**WARNING!**

- A seat belt that is worn under your arm is dangerous. Your body could strike the inside surfaces of the vehicle in a collision, increasing head and neck injury. A seat belt worn under the arm can cause internal injuries. Ribs aren't as strong as shoulder bones. Wear the seat belt over your shoulder so that your strongest bones will take the force in a collision.
- A shoulder belt placed behind you will not protect you from injury during a collision. You are more likely to hit your head in a collision if you do not wear your shoulder belt. The lap and shoulder belt are meant to be used together.
- A frayed or torn seat belt could rip apart in a collision and leave you with no protection. Inspect the seat belt system periodically, checking for cuts, frays, or loose parts. Damaged parts must be replaced immediately. Do not disassemble or modify the seat belt system. If your vehicle is involved in a collision, or if you have questions regarding seat belt or retractor conditions, take your vehicle to an authorized FCA dealer or authorized FCA Certified Collision Care Program facility for inspection.

## Lap/Shoulder Belt Operating Instructions

1. Enter the vehicle and close the door. Sit back and adjust the seat.
2. The seat belt latch plate is above the back of the front seat, and next to your arm in the rear seat (for vehicles equipped with a rear seat). Grab the latch plate and pull out the seat belt. Slide the latch plate up the webbing as far as necessary to allow the seat belt to go around your lap.

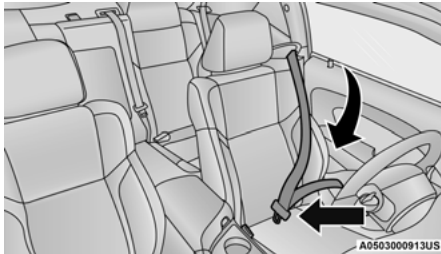

**Pulling Out The Latch Plate**

3. When the seat belt is long enough to fit, insert the latch plate into the buckle until you hear a “click.”

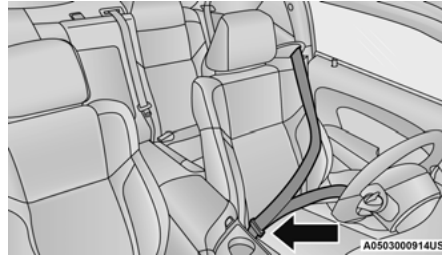

**Inserting Latch Plate Into Buckle**

4. Position the lap belt so that it is snug and lies low across your hips, below your abdomen. To remove slack in the lap belt portion, pull up on the shoulder belt. To loosen the lap belt if it is too tight, tilt the latch plate and pull on the lap belt. A snug seat belt reduces the risk of sliding under the seat belt in a collision.

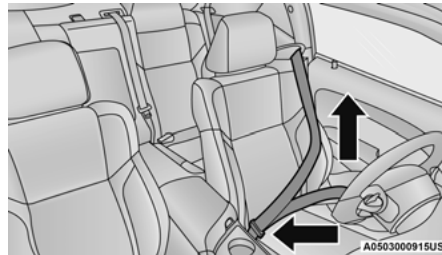

**Positioning The Lap Belt**

5. Position the shoulder belt across the shoulder and chest with minimal, if any slack so that it is comfortable and not resting on your neck. The retractor will withdraw any slack in the shoulder belt.
6. To release the seat belt, push the red button on the buckle. The seat belt will automatically retract to its stowed position. If necessary, slide the latch plate down the webbing to allow the seat belt to retract fully.

## Lap/Shoulder Belt Untwisting Procedure

Use the following procedure to untwist a twisted lap/shoulder belt.

1. Position the latch plate as close as possible to the anchor point.
2. At about 6 to 12 inches (15 to 30 cm) above the latch plate, grab and twist the seat belt webbing 180 degrees to create a fold that begins immediately above the latch plate.
3. Slide the latch plate upward over the folded webbing. The folded webbing must enter the slot at the top of the latch plate.
4. Continue to slide the latch plate up until it clears the folded webbing and the seat belt is no longer twisted.

## Seat Belt Extender

If a seat belt is not long enough to fit properly, even when the webbing is fully extended and the adjustable upper shoulder belt anchorage (if equipped) is in its lowest position, an authorized dealer can provide you with a Seat Belt Extender. The Seat Belt Extender should be used only if the existing seat belt is not long enough. When the Seat Belt Extender is not required for a different occupant, it must be removed.

### WARNING!

- ONLY use a Seat Belt Extender if it is physically required in order to properly fit the original seat belt system. DO NOT USE the Seat Belt Extender if, when worn, the distance between the front edge of the Seat Belt Extender buckle and the center of the occupant's body is LESS than 6 inches.
- Using a Seat Belt Extender when not needed can increase the risk of serious injury or death in a collision. Only use the Seat Belt Extender when the lap belt is not long enough and only use in the recommended seating positions. Remove and store the Seat Belt Extender when not needed.

## Seat Belts And Pregnant Women

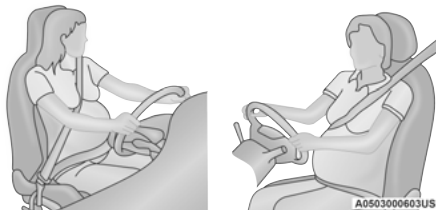

Seat Belts And Pregnant Women

Seat belts must be worn by all occupants including pregnant women: the risk of injury in the event of an accident is reduced for the mother and the unborn child if they are wearing a seat belt.

Position the lap belt snug and low below the abdomen and across the strong bones of the hips. Place the shoulder belt across the chest and away from the neck. Never place the shoulder belt behind the back or under the arm.

### Seat Belt Pretensioner

The front outboard seat belt system is equipped with pretensioning devices that are designed to remove slack from the seat belt in the event of a collision. These devices may improve the performance of the seat belt by removing slack from the seat belt early in a collision.

Pretensioners work for all size occupants, including those in child restraints.

### NOTE:

These devices are not a substitute for proper seat belt placement by the occupant. The seat belt still must be worn snugly and positioned properly.

The pretensioners are triggered by the Occupant Restraint Controller (ORC). Like the air bags, the pretensioners are single use items. A deployed pretensioner or a deployed air bag must be replaced immediately.

### Energy Management Feature

The front outboard seat belt system is equipped with an Energy Management feature that may help further reduce the risk of injury in the event of a collision. The seat belt system has a retractor assembly that is designed to release webbing in a controlled manner.

### Switchable Automatic Locking Retractors (ALR)

The seat belts in the passenger seating positions are equipped with a Switchable Automatic Locking Retractor (ALR) which is used to secure a child restraint system → page 221.

The figure below illustrates the locking feature for each seating position.

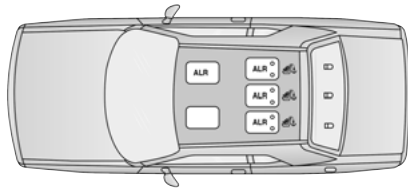

A0503000917US

### Vehicle With Rear Seating

ALR — Switchable Automatic Locking Retractor

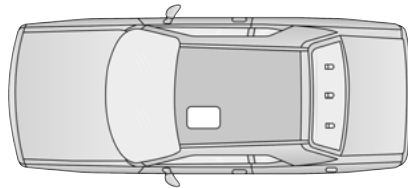

A0503000919US

### Passenger Seat Delete — No Automatic Locking Retractor (ALR) Locations

If the passenger seating position is equipped with an ALR and is being used for normal usage, only pull the seat belt webbing out far enough to comfortably wrap around the occupant's mid-section so as to not activate the ALR. If the ALR is activated, you will hear a clicking sound as the seat belt retracts. Allow the webbing to retract completely in this case and then carefully pull out only the amount of webbing necessary to comfortably wrap around the occupant's mid-section. Slide the latch plate into the buckle until you hear a "click."

In Automatic Locking Mode, the shoulder belt is automatically pre-locked. The seat belt will still retract to remove any slack in the shoulder belt. Use the Automatic Locking Mode anytime a child restraint is installed in a seating position that has a seat belt with this feature.

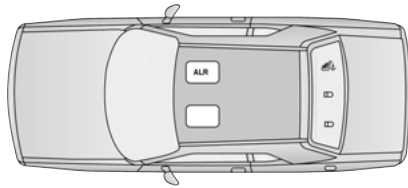

A0503000918US

### Rear Seat Delete — Only Front Passenger Seat Available

ALR — Switchable Automatic Locking Retractor

Children 12 years old and under should always be properly restrained in the rear seat of a vehicle with a rear seat.

#### WARNING!

- Never place a rear-facing child restraint in front of an air bag. A deploying passenger front air bag can cause death or serious injury to a child 12 years or younger, including a child in a rear-facing child restraint.
- Never install a rear-facing child restraint in the front seat of a vehicle. Only use a rear-facing child restraint in the rear seat. If the vehicle does not have a rear seat, do not transport a rear-facing child restraint in that vehicle.

6

#### How To Engage The Automatic Locking Mode

1. Buckle the combination lap and shoulder belt.
2. Grab the shoulder portion and pull downward until the entire seat belt is extracted.
3. Allow the seat belt to retract. As the seat belt retracts, you will hear a clicking sound. This indicates the seat belt is now in the Automatic Locking Mode.

### How To Disengage The Automatic Locking Mode

Unbuckle the combination lap/shoulder belt and allow it to retract completely to disengage the Automatic Locking Mode and activate the vehicle sensitive (emergency) locking mode.

#### WARNING!

- The seat belt assembly must be replaced if the switchable Automatic Locking Retractor (ALR) feature or any other seat belt function is not working properly when checked according to the procedures in the Service Manual.
- Failure to replace the seat belt assembly could increase the risk of injury in collisions.
- Do not use the Automatic Locking Mode to restrain occupants who are wearing the seat belt or children who are using booster seats. The locked mode is only used to install rear-facing or forward-facing child restraints that have a harness for restraining the child.

## SUPPLEMENTAL RESTRAINT SYSTEMS (SRS)

All passenger occupants within the vehicle must be in a seat equipped with a Seat Belt System and Head Restraint for the safety of the passenger.

If the front passenger and/or rear seats have been removed do not ride in those areas.

Some of the safety features described in this section may be standard equipment on some models, or may be optional equipment on others. If you are not sure, ask an authorized dealer.

The air bag system must be ready to protect you in a collision. The Occupant Restraint Controller (ORC) monitors the internal circuits and interconnecting wiring associated with the electrical Air Bag System Components. Your vehicle may be equipped with the following Air Bag System Components:

### Air Bag System Components

- Occupant Restraint Controller (ORC)
- Air Bag Warning Light 
- Steering Wheel and Column
- Instrument Panel
- Knee Impact Bolsters
- Driver and Front Passenger Air Bags
- Seat Belt Buckle Switch
- Supplemental Side Air Bags
- Front and Side Impact Sensors
- Seat Belt Pretensioners
- Seat Track Position Sensors

### NOTE:

Vehicles with front passenger seat deleted will not be equipped with the Seat Belt Buckle Switch, Seat Belt Pretensioner, Supplemental Seat Mounted Side Airbag, and Seat Track Position Sensors for the front passenger.

All passenger occupants within the vehicle must be in a seat equipped with a Seat Belt System and Head Restraint for the safety of the passenger.

If the front passenger and/or rear seats have been removed do not ride in those areas.

### Air Bag Warning Light



The Occupant Restraint Controller (ORC) monitors the readiness of the electronic parts of the air bag system whenever the ignition switch is in the START or ON/RUN position. If the ignition switch is in the OFF position or in the ACC position, the air bag system is not on and the air bags will not inflate.

The ORC contains a backup power supply system that may deploy the air bag system even if the battery loses power or it becomes disconnected prior to deployment.



The ORC turns on the Air Bag Warning Light in the instrument panel for approximately four to eight seconds for a self-check when the ignition switch is first in the ON/RUN position. After the self-check, the Air Bag Warning Light will turn off. If the ORC detects a malfunction in any part of the system, it turns on the Air Bag Warning Light, either momentarily or continuously. A single chime will sound to alert you if the light comes on again after initial startup.

The ORC also includes diagnostics that will illuminate the instrument panel Air Bag Warning Light if a malfunction is detected that could affect the air bag system. The diagnostics also record the nature of the malfunction. While the air bag system is designed to be maintenance free, if any of the following occurs, have an authorized dealer service the air bag system immediately.

- The Air Bag Warning Light does not come on during the four to eight seconds when the ignition switch is first in the ON/RUN position.
- The Air Bag Warning Light remains on after the four to eight-second interval.
- The Air Bag Warning Light comes on intermittently or remains on while driving.

#### NOTE:

If the speedometer, tachometer, or any engine related gauges are not working, the Occupant Restraint Controller (ORC) may also be disabled. In this condition the air bags may not be ready to inflate for your protection. Have an authorized dealer service the air bag system immediately.

#### WARNING!

Ignoring the Air Bag Warning Light in your instrument panel could mean you won't have the air bag system to protect you in a collision. If the light does not come on as a bulb check when the ignition is first turned on, stays on after you start the vehicle, or if it comes on as you drive, have an authorized dealer service the air bag system immediately.

#### Redundant Air Bag Warning Light



If a fault with the Air Bag Warning Light is detected, which could affect the Supplemental Restraint System (SRS), the Redundant Air Bag Warning Light will illuminate on the instrument panel. The Redundant Air Bag Warning Light will stay on until the fault is cleared. In addition, a single chime will sound to alert you that the Redundant Air Bag Warning Light has come on and a fault has been detected.

If the Redundant Air Bag Warning Light comes on intermittently or remains on while driving have an authorized dealer service the vehicle immediately page 69.

#### Front Air Bags

This vehicle has front air bags and lap/shoulder belts for both the driver and front passenger. The front air bags are a supplement to the seat belt restraint systems. The driver front air bag is mounted in the center of the steering wheel. The passenger front air bag is mounted in the instrument panel, above the glove compartment. The words "SRS AIRBAG" or "AIRBAG" are embossed on the air bag covers.

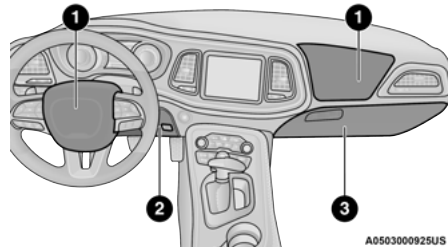

Front Air Bags/ Knee Impact Bolster Locations

- 1 — Driver And Passenger Front Air Bags
- 2 — Driver Knee Impact Bolster
- 3 — Passenger Knee Impact Bolster

**WARNING!**

- Being too close to the steering wheel or instrument panel during front air bag deployment could cause serious injury, including death. Air bags need room to inflate. Sit back, comfortably extending your arms to reach the steering wheel or instrument panel.
- Never place a rear-facing child restraint in front of an air bag. A deploying passenger front air bag can cause death or serious injury to a child 12 years or younger, including a child in a rear-facing child restraint.
- Never install a rear-facing child restraint in the front seat of a vehicle. Only use a rear-facing child restraint in the rear seat. If the vehicle does not have a rear seat, do not transport a rear-facing child restraint in that vehicle.

### Driver And Passenger Front Air Bag Features

The Advanced Front Air Bag system has multistage driver and front passenger air bags. This system provides output appropriate to the severity and type of collision as determined by the Occupant Restraint Controller (ORC), which may receive information from the front impact sensors (if equipped) or other system components.

The first stage inflator is triggered immediately during an impact that requires air bag deployment. A low energy output is used in less severe collisions. A higher energy output is used for more severe collisions.

This vehicle may be equipped with a driver and/or front passenger seat belt buckle switch that detects whether the driver or front passenger seat belt is buckled. The seat belt buckle switch may adjust the inflation rate of the Advanced Front Air Bags.

This vehicle may be equipped with driver and/or front passenger seat track position sensors that may adjust the inflation rate of the Advanced Front Air Bags based upon seat position.

**WARNING!**

- No objects should be placed over or near the air bag on the instrument panel or steering wheel because any such objects could cause harm if the vehicle is in a collision severe enough to cause the air bag to inflate.
- Do not put anything on or around the air bag covers or attempt to open them manually. You may damage the air bags and you could be injured because the air bags may no longer be functional. The protective covers for the air bag cushions are designed to open only when the air bags are inflating.

*(Continued)*

**WARNING!**

- Relying on the air bags alone could lead to more severe injuries in a collision. The air bags work with your seat belt to restrain you properly. In some collisions, air bags won't deploy at all. Always wear your seat belts even though you have air bags.

### Front Air Bag Operation

Front Air Bags are designed to provide additional protection by supplementing the seat belts. Front air bags are not expected to reduce the risk of injury in rear, side, or rollover collisions. The front air bags will not deploy in all frontal collisions, including some that may produce substantial vehicle damage — for example, some pole collisions, truck underrides, and angle offset collisions.

On the other hand, depending on the type and location of impact, front air bags may deploy in crashes with little vehicle front-end damage but that produce a severe initial deceleration.

Because air bag sensors measure vehicle deceleration over time, vehicle speed and damage by themselves are not good indicators of whether or not an air bag should have deployed.

Seat belts are necessary for your protection in all collisions, and also are needed to help keep you in position, away from an inflating air bag.

When the Occupant Restraint Controller (ORC) detects a collision requiring the front air bags, it signals the inflator units. A large quantity of non-toxic gas is generated to inflate the front air bags.

The steering wheel hub trim cover and the upper passenger side of the instrument panel separate and fold out of the way as the air bags inflate to their full size. The front air bags fully inflate in less time than it takes to blink your eyes. The front air bags then quickly deflate while helping to restrain the driver and front passenger.

### Knee Impact Bolsters

The Knee Impact Bolsters help protect the knees of the driver and front passenger, and position the front occupants for improved interaction with the front air bags.

#### WARNING!

- Do not drill, cut, or tamper with the knee impact bolsters in any way.
- Do not mount any accessories to the knee impact bolsters such as alarm lights, stereos, citizen band radios, etc.

### Supplemental Side Air Bags

#### Supplemental Seat-Mounted Side Air Bags (SABs)

This vehicle is equipped with Supplemental Seat-Mounted Side Air Bags (SABs).

Supplemental Seat-Mounted Side Air Bags (SABs) are located in the outboard side of the front seats. The SABs are marked with “SRS AIRBAG” or “AIRBAG” on a label or on the seat trim on the outboard side of the seats.

The SABs may help to reduce the risk of occupant injury during certain side impacts, in addition to the injury reduction potential provided by the seat belts and body structure.

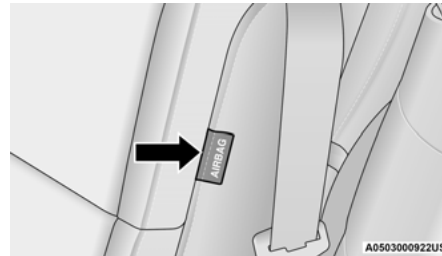

Front Supplemental Seat-Mounted Side Air Bag Label

When the SAB deploys, it opens the seam on the outboard side of the seatback's trim cover. The inflating SAB deploys through the seat seam into the space between the occupant and the door. The SAB moves at a very high speed and with such a high force that it could injure occupants if they are not seated properly, or if items are positioned in the area where the SAB inflates. Children are at an even greater risk of injury from a deploying air bag.

#### WARNING!

Do not use accessory seat covers or place objects between you and the Side Air Bags; the performance could be adversely affected and/or objects could be pushed into you, causing serious injury.

### Supplemental Side Air Bag Inflatable Curtains (SABICs)

This vehicle is equipped with Supplemental Side Air Bag Inflatable Curtains (SABICs).

Supplemental Side Air Bag Inflatable Curtains (SABICs) are located above the side windows. The trim covering the SABICs is labeled “SRS AIRBAG” or “AIRBAG.”

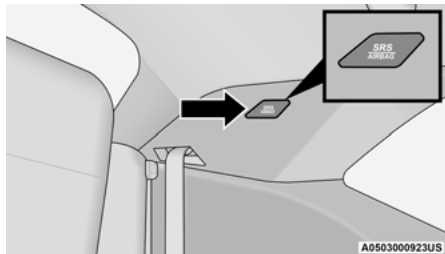

**Supplemental Side Air Bag Inflatable Curtain (SABIC)  
Label Location**

SABICs may help reduce the risk of head and other injuries to front and rear seat outboard occupants in certain side impacts, in addition to the injury reduction potential provided by the seat belts and body structure.

The SABIC deploys downward, covering the side windows. An inflating SABIC pushes the outside edge of the headliner out of the way and covers the window. The SABICs inflate with enough force to injure occupants if they are not belted and seated properly, or if items are positioned in the area where the SABICs inflate. Children are at an even greater risk of injury from a deploying air bag.

The SABICs may help reduce the risk of partial or complete ejection of vehicle occupants through side windows in certain side impact events.

#### WARNING!

- Do not mount equipment, or stack luggage or other cargo up high enough to block the deployment of the SABICs. The trim covering above the side windows where the SABIC and its deployment path are located should remain free from any obstructions.
- In order for the SABICs to work as intended, do not install any accessory items in your vehicle which could alter the roof. Do not add an aftermarket sunroof to your vehicle. Do not add roof racks that require permanent attachments (bolts or screws) for installation on the vehicle roof. Do not drill into the roof of the vehicle for any reason.

### Side Impacts

The Side Air Bags are designed to activate in certain side impacts. The Occupant Restraint Controller (ORC) determines whether the deployment of the Side Air Bags in a particular impact event is appropriate, based on the severity and type of collision. The side impact sensors aid the ORC in determining the appropriate response to impact events. The system is calibrated to deploy the Side Air Bags on the impact side of the vehicle during impacts that require Side Air Bag occupant protection. In side impacts, the Side Air Bags deploy independently; a left side impact deploys the left Side Air Bags only and a right-side impact deploys the right Side Air Bags only. Vehicle damage by itself is not a good indicator of whether or not Side Air Bags should have deployed.

The Side Air Bags will not deploy in all side collisions, including some collisions at certain angles, or some side collisions that do not impact the area of the passenger compartment. The Side Air Bags may deploy during angled or offset frontal collisions where the front air bags deploy.

Side Air Bags are a supplement to the seat belt restraint system. Side Air Bags deploy in less time than it takes to blink your eyes.

**WARNING!**

- Occupants, including children, who are up against or very close to Side Air Bags can be seriously injured or killed. Occupants, including children, should never lean on or sleep against the door, side windows, or area where the side air bags inflate, even if they are in an infant or child restraint.
- Seat belts (and child restraints where appropriate) are necessary for your protection in all collisions. They also help keep you in position, away from an inflating Side Air Bag. To get the best protection from the Side Air Bags, occupants must wear their seat belts properly and sit upright with their backs against the seats. Children must be properly restrained in a child restraint or booster seat that is appropriate for the size of the child.

**WARNING!**

- Side Air Bags need room to inflate. Do not lean against the door or window. Sit upright in the center of the seat.
- Being too close to the Side Air Bags during deployment could cause you to be severely injured or killed.
- Relying on the Side Air Bags alone could lead to more severe injuries in a collision. The Side Air Bags work with your seat belt to restrain you properly. In some collisions, Side Air Bags won't deploy at all. Always wear your seat belt even though you have Side Air Bags.

**NOTE:**

Air bag covers may not be obvious in the interior trim, but they will open during air bag deployment.

**Rollover Events**

Side Air Bags and seat belt pretensioners are designed to activate in certain rollover events. The Occupant Restraint Controller (ORC) determines whether deployment in a particular rollover event is appropriate, based on the severity and type of collision. Vehicle damage by itself is not a good indicator of whether or not Side Air Bags and seat belt pretensioners should have deployed.

The Side Air Bags and seat belt pretensioners will not deploy in all rollover events. The rollover sensing system determines if a rollover event may be in progress and whether deployment is appropriate. In the event the vehicle experiences a rollover or near rollover event, and deployment is appropriate, the rollover sensing system will deploy the side air bags and seat belt pretensioners on both sides of the vehicle.

The SABICs may help reduce the risk of partial or complete ejection of vehicle occupants through side windows in certain rollover or side impact events.

## Air Bag System Components

### NOTE:

The Occupant Restraint Controller (ORC) monitors the internal circuits and interconnecting wiring associated with electrical Air Bag System Components listed below:

- Occupant Restraint Controller (ORC)
- Air Bag Warning Light 
- Steering Wheel and Column
- Instrument Panel
- Knee Impact Bolsters
- Driver and Front Passenger Air Bags
- Seat Belt Buckle Switch
- Supplemental Side Air Bags
- Front and Side Impact Sensors
- Seat Belt Pretensioners
- Seat Track Position Sensors

### NOTE:

Vehicles with front passenger seat deleted will not be equipped with the Seat Belt Buckle Switch, Seat Belt Pretensioner, Supplemental Seat Mounted Side Airbag, and Seat Track Position Sensors for the front passenger.

## If A Deployment Occurs

The front air bags are designed to deflate immediately after deployment.

### NOTE:

Front and/or side air bags will not deploy in all collisions. This does not mean something is wrong with the air bag system.

If you do have a collision which deploys the air bags, any or all of the following may occur:

- The air bag material may sometimes cause abrasions and/or skin reddening to the occupants as the air bags deploy and unfold. The abrasions are similar to friction rope burns or those you might get sliding along a carpet or gymnasium floor. They are not caused by contact with chemicals. They are not permanent and normally heal quickly. However, if you haven't healed significantly within a few days, or if you have any blistering, see your doctor immediately.
- As the air bags deflate, you may see some smoke-like particles. The particles are a normal by-product of the process that generates the non-toxic gas used for air bag inflation. These airborne particles may irritate the skin, eyes, nose, or throat. If you have skin or eye irritation, rinse the area with cool water.

For nose or throat irritation, move to fresh air. If the irritation continues, see your doctor. If these particles settle on your clothing, follow the garment manufacturer's instructions for cleaning.

Do not drive your vehicle after the air bags have deployed. If you are involved in another collision, the air bags will not be in place to protect you.

### WARNING!

Deployed air bags and seat belt pretensioners cannot protect you in another collision. Have the air bags, seat belt pretensioners, and the seat belt retractor assemblies replaced by an authorized dealer immediately. Also, have the Occupant Restraint Controller System serviced as well.

### NOTE:

- Air bag covers may not be obvious in the interior trim, but they will open during air bag deployment.
- After any collision, the vehicle should be taken to an authorized dealer immediately.

## Enhanced Accident Response System

In the event of an impact, if the communication network remains intact, and the power remains intact, depending on the nature of the event, the Occupant Restraint Controller (ORC) will determine whether to have the Enhanced Accident Response System perform the following functions:

- Cut off fuel to the engine (if equipped).
- Cut off battery power to the electric motor (if equipped).
- Flash hazard lights as long as the battery has power.
- Turn on the interior lights, which remain on as long as the battery has power or for 15 minutes from the intervention of the Enhanced Accident Response System.
- Unlock the power door locks.

Your vehicle may also be designed to perform any of these other functions in response to the Enhanced Accident Response System:

- Turn off the Fuel Filter Heater, Turn off the HVAC Blower Motor, Close the HVAC Circulation Door

- Cut off battery power to the:
  - Engine
  - Electric Motor (if equipped)
  - Electric power steering
  - Brake booster
  - Electric park brake
  - Automatic transmission gear selector
  - Horn
  - Front wiper
  - Headlamp washer pump

### NOTE:

After an accident, remember to cycle the ignition to the STOP (OFF/LOCK) position and remove the key from the ignition switch to avoid draining the battery. Carefully check the vehicle for fuel leaks in the engine compartment and on the ground near the engine compartment and fuel tank before resetting the system and starting the engine. If there are no fuel leaks or damage to the vehicle electrical devices (e.g. headlights) after an accident, reset the system by following the procedure described below. If you have any doubt, contact an authorized dealer.

## Enhanced Accident Response System Reset Procedure

In order to reset the Enhanced Accident Response System functions after an event, the ignition switch must be changed from ignition START or ON/RUN to ignition OFF. Carefully check the vehicle for fuel leaks in the engine compartment and on the ground near the engine compartment and fuel tank before resetting the system and starting the engine.

After an accident, if the vehicle will not start after performing the reset procedure, the vehicle must be towed to an authorized dealer to be inspected and to have the Enhanced Accident Response System reset.

## Maintaining Your Air Bag System

### WARNING!

- Modifications to any part of the air bag system could cause it to fail when you need it. You could be injured if the air bag system is not there to protect you. Do not modify the components or wiring, including adding any kind of badges or stickers to the steering wheel hub trim cover or the upper passenger side of the instrument panel. Do not modify the front fascia/bumper, vehicle body structure, or add aftermarket side steps or running boards.
- It is dangerous to try to repair any part of the air bag system yourself. Be sure to tell anyone who works on your vehicle that it has an air bag system.

*(Continued)*

### WARNING!

- Do not attempt to modify any part of your air bag system. The air bag may inflate accidentally or may not function properly if modifications are made. Take your vehicle to an authorized dealer for any air bag system service. If your seat, including your trim cover and cushion, needs to be serviced in any way (including removal or loosening/tightening of seat attachment bolts), take the vehicle to an authorized dealer. Only manufacturer approved seat accessories may be used. If it is necessary to modify the air bag system for persons with disabilities, contact an authorized dealer.

## Event Data Recorder (EDR)

This vehicle is equipped with an event data recorder (EDR). The main purpose of an EDR is to record, in certain crash or near crash-like situations, such as an air bag deployment or hitting a road obstacle, data that will assist in understanding how a vehicle's systems performed. The EDR is designed to record data related to vehicle dynamics and safety systems for a short period of time, typically 30 seconds or less. The EDR in this vehicle is designed to record such data as:

- How various systems in your vehicle were operating;
- Whether or not the driver and passenger safety belts were buckled/fastened;
- How far (if at all) the driver was depressing the accelerator and/or brake pedal; and,
- How fast the vehicle was traveling.



These data can help provide a better understanding of the circumstances in which crashes and injuries occur.

#### NOTE:

EDR data are recorded by your vehicle only if a non-trivial crash situation occurs; no data are recorded by the EDR under normal driving conditions and no personal data (e.g., name, gender, age, and crash location) are recorded. However, other parties, such as law enforcement, could combine the EDR data with the type of personally identifying data routinely acquired during a crash investigation.

To read data recorded by an EDR, special equipment is required, and access to the vehicle or the EDR is needed. In addition to the vehicle manufacturer, other parties, such as law enforcement, that have the special equipment, can read the information if they have access to the vehicle or the EDR.

## CHILD RESTRAINTS

Everyone in your vehicle needs to be buckled up at all times, including babies and children. Every state in the United States, and every Canadian province, requires that small children ride in proper restraint systems. This is the law, and you can be prosecuted for ignoring it.

Children 12 years or younger should ride properly buckled up in a rear seat, if available.

According to crash statistics, children are safer when properly restrained in the rear seats rather than in the front.

If your vehicle is not equipped with a rear seat, FCA US LLC recommends that you do not allow children 12 years old and under to ride in your vehicle. If the rear seats are not present in your vehicle, NEVER install a child restraint in these positions.

#### WARNING!

In a collision, an unrestrained child can become a projectile inside the vehicle. The force required to hold even an infant on your lap could become so great that you could not hold the child, no matter how strong you are. The child and others could be badly injured or killed. Any child riding in your vehicle should be in a proper restraint for the child's size.

There are different sizes and types of restraints for children from newborn size to the child almost large enough for an adult safety belt. Always check the child seat Owner's Manual to make sure you have the correct seat for your child. Carefully read and follow all the instructions and warnings in the child restraint Owner's Manual and on all the labels attached to the child restraint.

Before buying any restraint system, make sure that it has a label certifying that it meets all applicable Safety Standards. You should also make sure that you can install it in the vehicle where you will use it.

#### NOTE:

- For additional information, refer to <http://www.nhtsa.gov/parents-and-caregivers> or call: 1-888-327-4236
- Canadian residents should refer to Transport Canada's website for additional information: <http://www.tc.gc.ca/en/services/road/child-car-seat-safety.html>

### Summary Of Recommendations For Restraining Children In Vehicles

	Child Size, Height, Weight Or Age	Recommended Type Of Child Restraint
Infants and Toddlers	Children who are two years old or younger and who have not reached the height or weight limits of their child restraint	Either an Infant Carrier or a Convertible Child Restraint, facing rearward in a rear seat of the vehicle
Small Children	Children who are at least two years old or who have outgrown the height or weight limit of their rear-facing child restraint	Forward-Facing Child Restraint with a five-point Harness, facing forward in a rear seat of the vehicle
Larger Children	Children who have outgrown their forward-facing child restraint, but are too small to properly fit the vehicle's seat belt	Belt Positioning Booster Seat and the vehicle seat belt, seated in a rear seat of the vehicle
Children Too Large for Child Restraints	Children 12 years old or younger, who have outgrown the height or weight limit of their booster seat	Vehicle Seat Belt, seated in a rear seat of the vehicle

#### NOTE:

If your vehicle is not equipped with a rear seat, FCA US LLC recommends that you do not allow children 12 years old and under to ride in your vehicle. If the rear seats are not present in your vehicle, NEVER install a child restraint in these positions. If you must install a forward facing child restraint in the front passenger seat, then you must use the seat belt system to secure the restraint. A top tether strap extension may be needed to reach the tether anchor on the rear shelf directly behind the passenger seat.

## Infant And Child Restraints

Safety experts recommend that children ride rear-facing in the vehicle until they are two years old or until they reach either the height or weight limit of their rear-facing child restraint. Two types of child restraints can be used rear-facing: infant carriers and convertible child seats.

The infant carrier is only used rear-facing in the vehicle. It is recommended for children from birth until they reach the weight or height limit of the infant carrier. Convertible child seats can be used either rear-facing or forward-facing in the vehicle. Convertible child seats often have a higher weight limit in the rear-facing direction than infant carriers do, so they can be used rear-facing by children who have outgrown their infant carrier but are still less than at least two years old. Children should remain rear-facing until they reach the highest weight or height allowed by their convertible child seat.

### WARNING!

- Never place a rear-facing child restraint in front of an air bag. A deploying passenger front air bag can cause death or serious injury to a child 12 years or younger, including a child in a rear-facing child restraint.

*(Continued)*

### WARNING!

- Never install a rear-facing child restraint in the front seat of a vehicle. Only use a rear-facing child restraint in the rear seat. If the vehicle does not have a rear seat, do not transport a rear-facing child restraint in that vehicle.

## Older Children And Child Restraints

### NOTE:

If your vehicle is not equipped with a rear seat, FCA US LLC recommends that you do not allow children 12 years old and under to ride in your vehicle. If the rear seats are not present in your vehicle, NEVER install a child restraint in these positions. If you must install a forward facing child restraint in the front passenger seat, then you must use the seat belt system to secure the restraint. A top tether strap extension may be needed to reach the tether anchor on the rear shelf directly behind the passenger seat.

Children who are two years old or who have outgrown their rear-facing convertible child seat can ride forward-facing in the vehicle. Forward-facing child seats and convertible child seats used in the forward-facing direction are for children who are over two years old or who have outgrown the rear-facing weight or height limit of their rear-facing convertible child seat. Children should remain in a forward-facing child seat with a harness for as long as possible, up to the highest weight or height allowed by the child seat.

All children whose weight or height is above the forward-facing limit for the child seat should use a belt-positioning booster seat until the vehicle's seat belts fit properly. If the child cannot sit with knees bent over the vehicle's seat cushion while the child's back is against the seatback, they should use a belt-positioning booster seat. The child and belt-positioning booster seat are held in the vehicle by the seat belt.

**WARNING!**

- Improper installation can lead to failure of an infant or child restraint. It could come loose in a collision. The child could be badly injured or killed. Follow the child restraint manufacturer's directions exactly when installing an infant or child restraint.
- After a child restraint is installed in the vehicle, do not move the vehicle seat forward or rearward because it can loosen the child restraint attachments. Remove the child restraint before adjusting the vehicle seat position. When the vehicle seat has been adjusted, reinstall the child restraint.
- When your child restraint is not in use, secure it in the vehicle with the seat belt or LATCH anchorages, or remove it from the vehicle. Do not leave it loose in the vehicle. In a sudden stop or accident, it could strike the occupants or seatbacks and cause serious personal injury.

**Children Too Large For Booster Seats****NOTE:**

If your vehicle is not equipped with a rear seat, FCA US LLC recommends that you do not allow children 12 years old and under to ride in your vehicle. If the rear seats are not present in your vehicle, NEVER install a child restraint in these positions.

Children who are large enough to wear the shoulder belt comfortably, and whose legs are long enough to bend over the front of the seat when their back is against the seatback, should use the seat belt in a rear seat. Use this simple 5-step test to decide whether the child can use the vehicle's seat belt alone:

1. Can the child sit all the way back against the back of the vehicle seat?
2. Do the child's knees bend comfortably over the front of the vehicle seat while the child is still sitting all the way back?
3. Does the shoulder belt cross the child's shoulder between the neck and arm?
4. Is the lap part of the belt as low as possible, touching the child's thighs and not the stomach?
5. Can the child stay seated like this for the whole trip?

If the answer to any of these questions was "no," then the child still needs to use a booster seat in this vehicle. If the child is using the lap/shoulder belt, check seat belt fit periodically and make sure the seat belt buckle is latched. A child's squirming or slouching can move the belt out of position. If the shoulder belt contacts the face or neck, move the child closer to the center of the vehicle, or use a booster seat to position the seat belt on the child correctly.

**WARNING!**

Never allow a child to put the shoulder belt under an arm or behind their back. In a crash, the shoulder belt will not protect a child properly, which may result in serious injury or death. A child must always wear both the lap and shoulder portions of the seat belt correctly.

**WARNING!**

If the rear or front passenger seats are not present in your vehicle, NEVER install a child restraint in these positions.

## Recommendations For Attaching Child Restraints

### NOTE:

If your vehicle is not equipped with a rear seat, FCA US LLC recommends that you do not allow children 12 years old and under to ride in your vehicle. If the rear seats are not present in your vehicle, NEVER install a child restraint in these positions.

Restraint Type	Combined Weight of the Child + Child Restraint	Use Any Attachment Method Shown With An "X" Below			
		LATCH – Lower Anchors Only	Seat Belt Only	LATCH – Lower Anchors + Top Tether Anchor	Seat Belt + Top Tether Anchor
Rear-Facing Child Restraint	Up to 65 lbs (29.5 kg)	X	X		
Rear-Facing Child Restraint	More than 65 lbs (29.5 kg)		X		
Forward-Facing Child Restraint	Up to 65 lbs (29.5 kg)			X	X
Forward-Facing Child Restraint	More than 65 lbs (29.5 kg)				X

## Lower Anchors And Tethers For Children (LATCH) Restraint System



**LATCH Label**

Your vehicle is equipped with the child restraint anchorage system called LATCH, which stands for Lower Anchors and Tethers for Children. The LATCH system has three vehicle anchor points for installing LATCH-equipped child seats. There are two lower anchorages located at the back of the seat cushion where it meets the seatback and one top tether anchorage located behind the seating position. These anchorages are used to install LATCH-equipped child seats without using the vehicle's seat belts.

Some seating positions may have a top tether anchorage but no lower anchorages. In these seating positions, the seat belt must be used with the top tether anchorage to install the child restraint. Please see the following table for more information.

### LATCH Positions For Installing Child Restraints In This Vehicle

#### WARNING!

If the rear or front passenger seats are not present in your vehicle, NEVER install a child restraint in these positions.

#### Vehicles Without Rear Seating Installed

If your vehicle is not equipped with a rear passenger seat, your vehicle is not equipped with LATCH anchorages. If your vehicle is not equipped with a rear seat, FCA US LLC recommends that you do not allow children 12 years old and under to ride in your vehicle. If the rear seats are not present in your vehicle, NEVER install a child restraint in these positions.

If you must install a forward facing child restraint in the front passenger seat, then you must use the seat belt system to secure the restraint. A top tether strap extension may be needed to reach the tether anchor on the rear shelf directly behind the passenger seat.

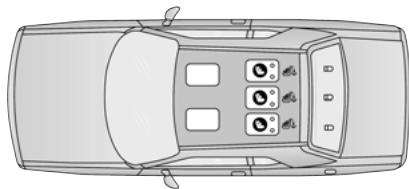

#### WARNING!

- Never place a rear-facing child restraint in front of an air bag. A deploying passenger front air bag can cause death or serious injury to a child 12 years or younger, including a child in a rear-facing child restraint.
- Never install a rear-facing child restraint in the front seat of a vehicle. Only use a rear-facing child restraint in the rear seat. If the vehicle does not have a rear seat, do not transport a rear-facing child restraint in that vehicle.



A0503000920US

**Vehicle With Rear Seating – LATCH Positions For Installing  
Child Restraints**

-  Lower Anchorage Symbol  
(2 Anchorages Per Seating Position)
  -  Top Tether Anchorage Symbol
- 

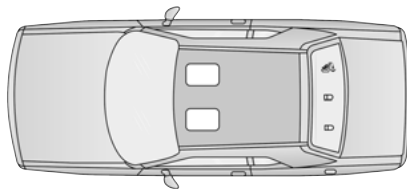

A0503000921US

**Rear Seat Delete – No LATCH Positions In This Vehicle**

 Top Tether Anchorage Symbol

---

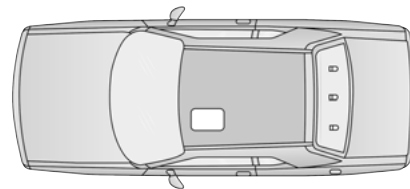

A0503000919US

**Passenger Seats Deleted – No LATCH Positions  
In This Vehicle**

Frequently Asked Questions About Installing Child Restraints With LATCH		
What is the weight limit (child's weight + weight of the child restraint) for using the LATCH anchorage system to attach the child restraint?	65 lbs (29.5 kg)	Use the LATCH anchorage system until the combined weight of the child and the child restraint is 65 lbs (29.5 kg). Use the seat belt and tether anchor instead of the LATCH system once the combined weight is more than 65 lbs (29.5 kg).
Can the LATCH anchorages and the seat belt be used together to attach a rear-facing or forward-facing child restraint?	No	Do not use the seat belt when you use the LATCH anchorage system to attach a rear-facing or forward-facing child restraint. Booster seats may be attached to the LATCH anchorages if allowed by the booster seat manufacturer. See your booster seat owner's manual for more information.
Can two child restraints be attached using a common lower LATCH anchorage?	No	Never "share" a LATCH anchorage with two or more child restraints. If the center position does not have dedicated LATCH lower anchorages, use the seat belt to install a child seat in the center position next to a child seat using the LATCH anchorages in an outboard position.
Can the rear-facing child restraint touch the back of the front passenger seat?	Yes	The child seat may touch the back of the front passenger seat if the child restraint manufacturer also allows contact. See your child restraint owner's manual for more information.
Can the rear head restraints be removed?	No	



## Locating The LATCH Anchorages

### WARNING!

If the rear or front passenger seats are not present in your vehicle, NEVER install a child restraint in these positions.



The lower anchorages are round bars that are found at the rear of the seat cushion where it meets the seatback, below the anchorage symbols on the seatback. They are just visible when you lean into the rear seat to install the child restraint. You will easily feel them if you run your finger along the gap between the seatback and seat cushion.

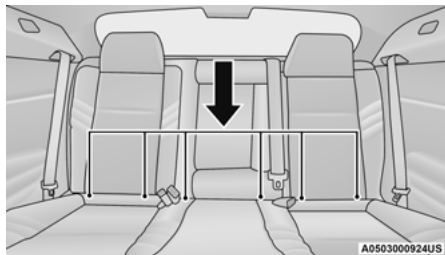

LATCH Anchorages

## Locating The Upper Tether Anchorages

### WARNING!

If the rear or front passenger seats are not present in your vehicle, NEVER install a child restraint in these positions.



There are tether strap anchorages behind each rear seating position located in the panel between the rear seatback and the rear window. They are found under a plastic cover with the tether anchorage symbol on it.

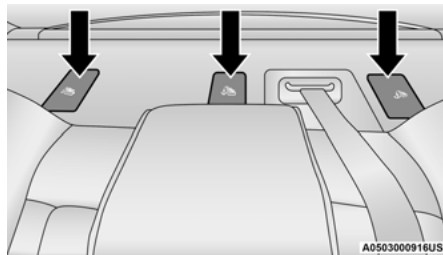

Tether Strap Anchorages

LATCH-compatible child restraint systems will be equipped with a rigid bar or a flexible strap on each side. Each will have a hook or connector to attach to the lower anchorage and a way to tighten the connection to the anchorage. Forward-facing child restraints and some rear-facing child restraints will also be equipped with a tether strap. The tether strap will have a hook at the end to attach to the top tether anchorage and a way to tighten the strap after it is attached to the anchorage.

## Center Seat LATCH

If a child restraint installed in the center position blocks the seat belt webbing or buckle for the outboard position, do not use that outboard position. If a child seat in the center position blocks the outboard LATCH anchors or seat belt, do not install a child seat in that outboard position.

### WARNING!

Never use the same lower anchorage to attach more than one child restraint. For typical installation instructions, see page 220.

**Always follow the directions of the child restraint manufacturer when installing your child restraint. Not all child restraint systems will be installed as described here.**

## To Install A LATCH-Compatible Child Restraint

If the selected seating position has a Switchable Automatic Locking Retractor (ALR) seat belt, stow the seat belt, following the instructions below. See ⇨ page 221 to check what type of seat belt each seating position has.

1. Loosen the adjusters on the lower straps and on the tether strap of the child seat so that you can more easily attach the hooks or connectors to the vehicle anchorages.
2. Place the child seat between the lower anchorages for that seating position. If the second row seat can be reclined, you may recline the seat and/or raise the head restraint (if adjustable) to get a better fit. If the rear seat can be moved forward and rearward in the vehicle, you may wish to move it to its rear-most position to make room for the child seat. You may also move the front seat forward to allow more room for the child seat.
3. Attach the lower hooks or connectors of the child restraint to the lower anchorages in the selected seating position.
4. If the child restraint has a tether strap, connect it to the top tether anchorage. See ⇨ page 225 for directions to attach a tether anchor.
5. Tighten all of the straps as you push the child restraint rearward and downward into the seat. Remove slack in the straps according to the child restraint manufacturer's instructions.
6. Test that the child restraint is installed tightly by pulling back and forth on the child seat at the belt path. It should not move more than 1 inch (25.4 mm) in any direction.

## How To Stow An Unused Switchable-ALR (ALR) Seat Belt:

When using the LATCH attaching system to install a child restraint, stow all ALR seat belts that are not being used by other occupants or being used to secure child restraints. An unused belt could injure a child if they play with it and accidentally lock the seat belt retractor. Before installing a child restraint using the LATCH system, buckle the seat belt behind the child restraint and out of the child's reach. If the buckled seat belt interferes with the child restraint installation, instead of buckling it behind the child restraint, route the seat belt through the child restraint belt path and then buckle it. Do not lock the seat belt. Remind all children in the vehicle that the seat belts are not toys and that they should not play with them.

**WARNING!**

- Improper installation of a child restraint to the LATCH anchorages can lead to failure of the restraint. The child could be badly injured or killed. Follow the child restraint manufacturer's directions exactly when installing an infant or child restraint.
- Child restraint anchorages are designed to withstand only those loads imposed by correctly-fitted child restraints. Under no circumstances are they to be used for adult seat belts, harnesses, or for attaching other items or equipment to the vehicle.

### Installing Child Restraints Using The Vehicle Seat Belt

**NOTE:**

If your vehicle is not equipped with a rear seat, FCA US LLC recommends that you do not allow children 12 years old and under to ride in your vehicle. If the rear seats are not present in your vehicle, NEVER install a child restraint in these positions.

Child restraint systems are designed to be secured in vehicle seats by lap belts or the lap belt portion of a lap/shoulder belt.

**WARNING!**

- Never place a rear-facing child restraint in front of an air bag. A deploying passenger front air bag can cause death or serious injury to a child 12 years or younger, including a child in a rear-facing child restraint.
- Never install a rear-facing child restraint in the front seat of a vehicle. Only use a rear-facing child restraint in the rear seat. If the vehicle does not have a rear seat, do not transport a rear-facing child restraint in that vehicle.

**WARNING!**

- Improper installation or failure to properly secure a child restraint can lead to failure of the restraint. The child could be badly injured or killed.
- Follow the child restraint manufacturer's directions exactly when installing an infant or child restraint.

The seat belts in the passenger seating positions are equipped with a Switchable Automatic Locking Retractor (ALR) that is designed to keep the lap portion of the seat belt tight around the child restraint so that it is not necessary to use a locking clip. The ALR retractor can be "switched" into a locked mode by pulling all of the webbing out of the retractor and then letting the webbing retract back into the retractor. If it is locked, the ALR will make a clicking noise while the webbing is pulled back into the retractor. Refer to the "Automatic Locking Mode" description on ⇨ page 200 for additional information on ALR.

Please see the table below and the following sections for more information.

## Lap/Shoulder Belt Systems For Installing Child Restraints In This Vehicle

### NOTE:

If your vehicle is not equipped with a rear seat, FCA US LLC recommends that you do not allow children 12 years old and under to ride in your vehicle. If the rear seats are not present in your vehicle, NEVER install a child restraint in these positions.

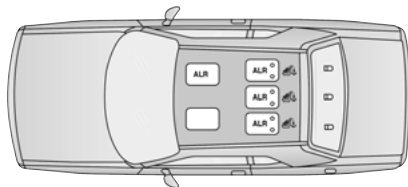

A0503000917US

### Vehicle With Rear Seating

ALR — Switchable Automatic Locking Retractor

 Top Tether Anchorage Symbol

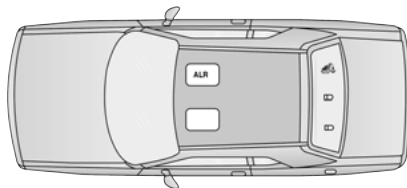

A0503000918US

### Rear Seat Delete — Only Front Passenger Seat Available

ALR — Switchable Automatic Locking Retractor

 Top Tether Anchorage Symbol

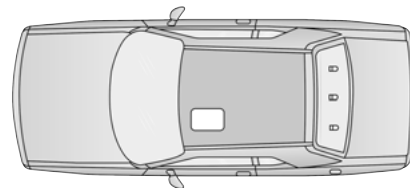

A0503000919US

### Passenger Seat Delete — No Automatic Locking Retractor (ALR) Locations

### Frequently Asked Questions About Installing Child Restraints With Seat Belts

What is the weight limit (child's weight + weight of the child restraint) for using the Tether Anchor with the seat belt to attach a forward facing child restraint?	Weight limit of the Child Restraint	Always use the tether anchor when using the seat belt to install a forward facing child restraint, up to the recommended weight limit of the child restraint.
Can the rear-facing child restraint touch the back of the front passenger seat?	Yes	Contact between the front passenger seat and the child restraint is allowed, if the child restraint manufacturer also allows contact.
Can the rear head restraints be removed?	No	
Can the buckle stalk be twisted to tighten the seat belt against the belt path of the child restraint?	No	Do not twist the buckle stalk in a seating position with an ALR retractor.

## Installing A Child Restraint With A Switchable Automatic Locking Retractor (ALR):

Child restraint systems are designed to be secured in vehicle seats by lap belts or the lap belt portion of a lap/shoulder belt.

### WARNING!

- Improper installation or failure to properly secure a child restraint can lead to failure of the restraint. The child could be badly injured or killed.
- Follow the child restraint manufacturer's directions exactly when installing an infant or child restraint.

1. Place the child seat in the center of the seating position. If the second row seat can be reclined, you may recline the seat and/or raise the head restraint (if adjustable) to get a better fit. If the rear seat can be moved forward and rearward in the vehicle, you may wish to move it to its rear-most position to make room for the child seat. You may also move the front seat forward to allow more room for the child seat.
2. Pull enough of the seat belt webbing from the retractor to pass it through the belt path of the child restraint. Do not twist the belt webbing in the belt path.
3. Slide the latch plate into the buckle until you hear a "click."
4. Pull on the webbing to make the lap portion tight against the child seat.
5. To lock the seat belt, pull down on the shoulder part of the belt until you have pulled all the seat belt webbing out of the retractor. Then, allow the webbing to retract back into the retractor. As the webbing retracts, you will hear a clicking sound. This means the seat belt is now in the Automatic Locking mode.
6. Try to pull the webbing out of the retractor. If it is locked, you should not be able to pull out any webbing. If the retractor is not locked, repeat step 5.
7. Finally, pull up on any excess webbing to tighten the lap portion around the child restraint while you push the child restraint rearward and downward into the vehicle seat.
8. If the child restraint has a top tether strap and the seating position has a top tether anchorage, connect the tether strap to the anchorage and tighten the tether strap. For directions to attach a tether anchor, see ⇨ page 225.
9. Test that the child restraint is installed tightly by pulling back and forth on the child seat at the belt path. It should not move more than 1 inch (25.4 mm) in any direction.

Any seat belt system will loosen with time, so check the belt occasionally, and pull it tight if necessary.

## Installing Child Restraints Using The Top Tether Anchorage:

### WARNING!

If the rear or front passenger seats are not present in your vehicle, NEVER install a child restraint in these positions.

### WARNING!

Do not attach a tether strap for a rear-facing car seat to any location in front of the car seat, including the seat frame or a tether anchorage. Only attach the tether strap of a rear-facing car seat to the tether anchorage that is approved for that seating position, located behind the top of the vehicle seat. For the location of approved tether anchorages in your vehicle, see [page 216](#).



1. Look behind the seating position where you plan to install the child restraint to find the tether anchorage. You may need to move the seat forward to provide better access to the tether anchorage. If there is no top tether anchorage for that seating position, move the child restraint to another position in the vehicle if one is available.
2. Rotate or lift the cover to access the anchor directly behind the seat where you are placing the child restraint.
3. Route the tether strap to provide the most direct path for the strap between the anchor and the child seat. If your vehicle is equipped with adjustable rear head restraints, raise the head restraint, and where possible, route the tether strap under the head restraint and between the two posts. If not possible, lower the head restraint and pass the tether strap around the outboard side of the head restraint.

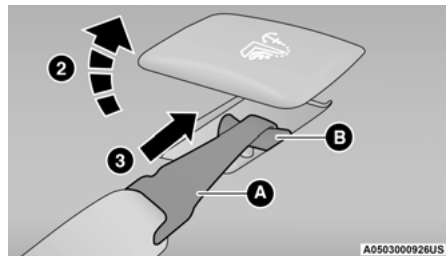

**Tether Strap Mounting**

2 — Cover

3 — Attaching Strap

A — Tether Strap Hook

B — Tether Anchor

4. Attach the tether strap hook of the child restraint to the top tether anchorage as shown in the diagram.
5. Remove slack in the tether strap according to the child restraint manufacturer's instructions.

**NOTE:**

If your vehicle is not equipped with a rear seat, FCA US LLC recommends that you do not allow children 12 years old and under to ride in your vehicle. If the rear seats are not present in your vehicle, NEVER install a child restraint in these positions. If you must install a forward facing child restraint in the front passenger seat, then you must use the seat belt system to secure the restraint. A top tether strap extension may be needed to reach the tether anchor on the rear shelf directly behind the passenger seat.

**WARNING!**

- An incorrectly anchored tether strap could lead to increased head motion and possible injury to the child. Use only the anchorage position directly behind the child seat to secure a child restraint top tether strap.
- If your vehicle is equipped with a split rear seat, make sure the tether strap does not slip into the opening between the seatbacks as you remove slack in the strap.

**SAFETY TIPS****TRANSPORTING PASSENGERS**

NEVER TRANSPORT PASSENGERS IN THE CARGO AREA.

**WARNING!**

- Do not leave children or animals inside parked vehicles in hot weather. Interior heat buildup may cause serious injury or death.
- It is extremely dangerous to ride in a cargo area, inside or outside of a vehicle. In a collision, people riding in these areas are more likely to be seriously injured or killed.
- Do not allow people to ride in any area of your vehicle that is not equipped with seats and seat belts.
- Be sure everyone in your vehicle is in a seat and using a seat belt properly.

**TRANSPORTING PETS**

Air Bags deploying in the front seat could harm your pet. An unrestrained pet will be thrown about and possibly injured, or injure a passenger during panic braking or in a collision.

Pets should be restrained in the rear seat (if equipped) in pet harnesses or pet carriers that are secured by seat belts.

**SAFETY CHECKS YOU SHOULD MAKE INSIDE THE VEHICLE****Seat Belts**

Inspect the seat belt system periodically, checking for cuts, frays, and loose parts. Damaged parts must be replaced immediately. Do not disassemble or modify the system.

If your vehicle is involved in a collision, or if you have questions regarding the seat belt or retractor conditions, take your vehicle to an authorized FCA dealer or authorized FCA Certified Collision Care Program facility for inspection.



## Air Bag Warning Light

The Air Bag Warning Light  will turn on for four to eight seconds as a bulb check when the ignition switch is first placed in the ON/RUN mode. If the light is either not on during starting, stays on, or turns on while driving, have the system inspected at an authorized dealer as soon as possible. After the bulb check, this light will illuminate with a single chime when a fault with the Air Bag System has been detected. It will stay on until the fault is removed. If the light comes on intermittently or remains on while driving, have an authorized dealer service the vehicle immediately  
 ➔ page 194.

## Defroster

Check operation by selecting the defrost mode and place the blower control on high speed. You should be able to feel the air directed against the windshield. See an authorized dealer for service if your defroster is inoperable.

## Floor Mat Safety Information

Always use floor mats designed to fit your vehicle. Only use a floor mat that does not interfere with the operation of the accelerator, brake or clutch pedals. Only use a floor mat that is securely attached using the floor mat fasteners so it cannot slip out of position and interfere with the accelerator, brake or clutch pedals or impair safe operation of your vehicle in other ways.

### WARNING!

An improperly attached, damaged, folded, or stacked floor mat, or damaged floor mat fasteners may cause your floor mat to interfere with the accelerator, brake, or clutch pedals and cause a loss of vehicle control. To prevent **SERIOUS INJURY or DEATH:**

- ALWAYS securely attach  your floor mat using the floor mat fasteners. **DO NOT** install your floor mat upside down or turn your floor mat over. Lightly pull down to confirm mat is secured using the floor mat fasteners on a regular basis.

*(Continued)*

### WARNING!

- ALWAYS REMOVE THE EXISTING FLOOR MAT FROM THE VEHICLE  before installing any other floor mat. NEVER install or stack an additional floor mat on top of an existing floor mat.
- ONLY install floor mats designed to fit your vehicle. NEVER install a floor mat that cannot be properly attached and secured to your vehicle. If a floor mat needs to be replaced, only use a FCA approved floor mat for the specific make, model, and year of your vehicle.
- ONLY use the driver's side floor mat on the driver's side floor area. To check for interference, with the vehicle properly parked with the engine off, fully depress the accelerator, the brake, and the clutch pedal (if present) to check for interference. If your floor mat interferes with the operation of any pedal, or is not secure to the floor, remove the floor mat from the vehicle and place the floor mat in your trunk.
- ONLY use the passenger's side floor mat on the passenger's side floor area.

*(Continued)*

**WARNING!**

- ALWAYS make sure objects cannot fall or slide into the driver's side floor area when the vehicle is moving. Objects can become trapped under accelerator, brake, or clutch pedals and could cause a loss of vehicle control.
- NEVER place any objects under the floor mat (e.g., towels, keys, etc.). These objects could change the position of the floor mat and may cause interference with the accelerator, brake, or clutch pedals.

*(Continued)*

**WARNING!**

- If the vehicle carpet has been removed and re-installed, always properly attach carpet to the floor and check the floor mat fasteners are secure to the vehicle carpet. Fully depress each pedal to check for interference with the accelerator, brake, or clutch pedals then re-install the floor mats.
- It is recommended to only use mild soap and water to clean your floor mats. After cleaning, always check your floor mat has been properly installed and is secured to your vehicle using the floor mat fasteners by lightly pulling mat.

**PERIODIC SAFETY CHECKS YOU SHOULD MAKE OUTSIDE THE VEHICLE****Tires**

Examine tires for excessive tread wear and uneven wear patterns. Check for stones, nails, glass, or other objects lodged in the tread or sidewall. Inspect the tread for cuts and cracks. Inspect sidewalls for cuts, cracks, and bulges. Check the lug nuts/bolt torque for tightness. Check the tires (including spare) for proper cold inflation pressure.

**Lights**

Have someone observe the operation of brake lights and exterior lights while you work the controls. Check turn signal and high beam indicator lights on the instrument panel.

## Door Latches

Check for proper closing, latching, and locking.

## Fluid Leaks

Check area under the vehicle after overnight parking for fuel, coolant, oil, or other fluid leaks. Also, if gasoline fumes are detected or if fuel or brake fluid leaks are suspected, the cause should be located and corrected immediately.

## EXHAUST GAS

### WARNING!

Exhaust gases can injure or kill. They contain carbon monoxide (CO), which is colorless and odorless. Breathing it can make you unconscious and can eventually poison you. To avoid breathing (CO), follow these safety tips:

- Do not run the engine in a closed garage or in confined areas any longer than needed to move your vehicle in or out of the area.

*(Continued)*

### WARNING!

- If you are required to drive with the trunk/lift-gate/rear doors open, make sure that all windows are closed and the climate control BLOWER switch is set at high speed. DO NOT use the recirculation mode.
- If it is necessary to sit in a parked vehicle with the engine running, adjust your heating or cooling controls to force outside air into the vehicle. Set the blower at high speed.

The best protection against carbon monoxide entry into the vehicle body is a properly maintained engine exhaust system.

Whenever a change is noticed in the sound of the exhaust system, when exhaust fumes can be detected inside the vehicle, or when the underside or rear of the vehicle is damaged, have an authorized dealer inspect the complete exhaust system and adjacent body areas for broken, damaged, deteriorated, or mispositioned parts. Open seams or loose connections could permit exhaust fumes to seep into the passenger compartment. In addition, inspect the exhaust system each time the vehicle is raised for lubrication or oil change. Replace as required.

## CARBON MONOXIDE WARNINGS

### WARNING!

Carbon monoxide (CO) in exhaust gases is deadly. Follow the precautions below to prevent carbon monoxide poisoning:

- Do not inhale exhaust gases. They contain carbon monoxide, a colorless and odorless gas, which can kill. Never run the engine in a closed area, such as a garage, and never sit in a parked vehicle with the engine running for an extended period. If the vehicle is stopped in an open area with the engine running for more than a short period, adjust the ventilation system to force fresh, outside air into the vehicle.
- Guard against carbon monoxide with proper maintenance. Have the exhaust system inspected every time the vehicle is raised. Have any abnormal conditions repaired promptly. Until repaired, drive with all side windows fully open.

## IN CASE OF EMERGENCY

### HAZARD WARNING FLASHERS

The Hazard Warning Flashers button is located on the instrument panel, below the radio.

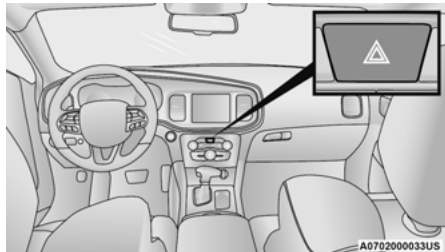

**Hazard Warning Flashers Button**

Push the button to turn on the Hazard Warning Flashers. When the button is activated, all directional turn signals will flash on and off to warn oncoming traffic of an emergency. Push the switch a second time to turn off the Hazard Warning Flashers.

This is an emergency warning system and it should not be used when the vehicle is in motion. Use it when your vehicle is disabled and it is creating a safety hazard for other motorists.

When you must leave the vehicle to seek assistance, the Hazard Warning Flashers will continue to operate even though the ignition is placed in the OFF position.

**NOTE:**

With extended use, the Hazard Warning Flashers may wear down your battery.

### ASSIST AND SOS MIRROR — IF EQUIPPED



**Assist And SOS Mirror**

If equipped, the rearview mirror contains an ASSIST and a SOS button.

#### WARNING!

ALWAYS obey traffic laws and pay attention to the road. ALWAYS drive safely with your hands on the steering wheel. You have full responsibility and assume all risks related to the use of the Uconnect and SiriusXM Guardian™ features and applications in this vehicle. Only use Uconnect features and SiriusXM Guardian™ services when it is safe to do so. Failure to do so may result in an accident involving serious injury or death.

**NOTE:**

- Your vehicle may be transmitting data as authorized by the subscriber ↗ page 318.
- The SOS and ASSIST buttons will only function if you are connected to an operable LTE (voice/data) or 4G (data) network. Other Uconnect services will only be operable if your SiriusXM Guardian™ service is active and you are connected to an operable LTE (voice/data) or 4G (data) network.

**ASSIST Call**

The ASSIST Button is used to automatically connect you to any one of the following support centers:

- Roadside Assistance – If you get a flat tire, or need a tow, just push the ASSIST button and you will be connected to a representative for assistance. Roadside Assistance will know what vehicle you're driving and its location. Additional fees may apply for roadside Assistance.
- SiriusXM Guardian™ Customer Care – In-vehicle support for SiriusXM Guardian™.
- Vehicle Customer Care – Total support for all other vehicle issues.
- Uconnect Customer Care - Total support for Radio, Phone and NAV issues.

**SOS Call**

1. Push the SOS Call button on the Rearview Mirror.

**NOTE:**

In case the SOS Call button is pushed in error, there will be a 10 second delay before the SOS Call system initiates a call to a SOS operator. To cancel the SOS Call connection, push the SOS call button on the Rearview Mirror or press the cancellation button on the Device Screen. Termination of the SOS Call will turn off the green LED light on the Rearview Mirror.

2. The LED light located between the ASSIST and SOS buttons on the Rearview Mirror will turn green once a connection to a SOS operator has been made.
3. Once a connection between the vehicle and a SOS operator is made, the SOS Call system may transmit the following important vehicle information to a SOS operator:
  - Indication that the occupant placed a SOS Call.
  - The vehicle brand.
  - The last known GPS coordinates of the vehicle.
4. You should be able to speak with the SOS operator through the vehicle audio system to determine if additional help is needed.

**WARNING!**

ALWAYS obey traffic laws and pay attention to the road. ALWAYS drive safely with your hands on the steering wheel. You have full responsibility and assume all risks related to the use of the Uconnect and SiriusXM Guardian™ features and applications in this vehicle. Only use Uconnect features and SiriusXM Guardian™ services when it is safe to do so. Failure to do so may result in an accident involving serious injury or death.

**NOTE:**

- Your vehicle may be transmitting data as authorized by the subscriber.
  - Once a connection is made between the vehicle's SOS Call system and the SOS operator, the SOS operator may be able to open a voice connection with the vehicle to determine if additional help is needed. Once the SOS operator opens a voice connection with the vehicle's SOS Call system, the operator should be able to speak with you or other vehicle occupants and hear sounds occurring in the vehicle. The vehicle's SOS Call system will attempt to remain connected with the SOS operator until the SOS operator terminates the connection.
5. The SOS operator may attempt to contact appropriate emergency responders and provide them with important vehicle information and GPS coordinates.

**WARNING!**

- If anyone in the vehicle could be in danger (e.g., fire or smoke is visible, dangerous road conditions or location), do not wait for voice contact from an Emergency Services Agent. All occupants should exit the vehicle immediately and move to a safe location.
- Never place anything on or near the vehicle's operable network and GPS antennas. You could prevent operable network and GPS signal reception, which can prevent your vehicle from placing an emergency call. An operable network and GPS signal reception is required for the SOS Call system to function properly.

*(Continued)*

**WARNING!**

- The SOS Call system is embedded into the vehicle's electrical system. Do not add aftermarket electrical equipment to the vehicle's electrical system. This may prevent your vehicle from sending a signal to initiate an emergency call. To avoid interference that can cause the SOS Call system to fail, never add aftermarket equipment (e.g., two-way mobile radio, CB radio, data recorder, etc.) to your vehicle's electrical system or modify the antennas on your vehicle. **IF YOUR VEHICLE LOSES BATTERY POWER FOR ANY REASON (INCLUDING DURING OR AFTER AN ACCIDENT), THE UCONNECT FEATURES, APPS AND SERVICES, AMONG OTHERS, WILL NOT OPERATE.**
- Modifications to any part of the SOS Call system could cause the air bag system to fail when you need it. You could be injured if the air bag system is not there to help protect you.

**SOS Call System Limitations**

Vehicles sold in Mexico **DO NOT** have SOS Call system capabilities.

SOS or other emergency line operators in Mexico may not answer or respond to SOS system calls.

If the SOS Call system detects a malfunction, any of the following may occur at the time the malfunction is detected, and at the beginning of each ignition cycle:

- The Rearview Mirror light located between the ASSIST and SOS buttons will continuously illuminate red.
- The Device Screen will display the following message "Vehicle device requires service". Please contact an authorized dealer.
- An In-Vehicle Audio message will state "Vehicle device requires service". Please contact an authorized dealer.

**WARNING!**

- Ignoring the Rearview Mirror light could mean you will not have SOS Call services. If the Rearview Mirror light is illuminated, have an authorized dealer service the SOS Call system immediately.
- The Occupant Restraint Control module turns on the air bag Warning Light on the instrument panel if a malfunction in any part of the system is detected. If the Air Bag Warning Light is illuminated, have an authorized dealer service the Occupant Restraint Control system immediately.

Even if the SOS Call system is fully functional, factors beyond FCA US LLC's control may prevent or stop the SOS Call system operation. These include, but are not limited to, the following factors:

- The ignition is in the OFF position.
- The vehicle's electrical systems are not intact.
- The SOS Call system software and/or hardware are damaged during a crash.
- The vehicle battery loses power or becomes disconnected during a vehicle crash.

- LTE (voice/data) or 4G (data) network and/or Global Positioning Satellite signals are unavailable or obstructed.
- Equipment malfunction at the SOS operator facility.
- Operator error by the SOS operator.
- LTE (voice/data) or 4G (data) network congestion.
- Weather.
- Buildings, structures, geographic terrain, or tunnels.

**WARNING!**

ALWAYS obey traffic laws and pay attention to the road. ALWAYS drive safely with your hands on the steering wheel. You have full responsibility and assume all risks related to the use of the Uconnect and SiriusXM Guardian™ features and applications in this vehicle. Only use Uconnect features and SiriusXM Guardian™ services when it is safe to do so. Failure to do so may result in an accident involving serious injury or death.

**NOTE:**

- Your vehicle may be transmitting data as authorized by the subscriber.
- Never place anything on or near the vehicle's LTE (voice/data) or 4G (data) and GPS antennas. You could prevent LTE (voice/data) or 4G (data) and GPS signal reception, which can prevent your vehicle from placing an emergency call. An operable LTE (voice/data) or 4G (data) network connection and a GPS signal is required for the SOS Call system to function properly.

**NOTE:**

Changes or modifications not expressly approved by the party responsible for compliance could void the user's authority to operate the equipment.

**CAUTION!**

To avoid damage to the mirror during cleaning, never spray any cleaning solution directly onto the mirror. Apply the solution onto a clean cloth and wipe the mirror clean.

**Automatic SOS — If Equipped**

Automatic SOS is a hands-free safety service that can immediately connect you with help in the event that your vehicle's airbags deploy. Please refer to your provided radio supplement for complete information.

## JACKING AND TIRE CHANGING

### WARNING!

- Do not attempt to change a tire on the side of the vehicle close to moving traffic. Pull far enough off the road to avoid the danger of being hit when operating the jack or changing the wheel.
- Being under a jacked-up vehicle is dangerous. The vehicle could slip off the jack and fall on you. You could be crushed. Never put any part of your body under a vehicle that is on a jack. If you need to get under a raised vehicle, take it to a service center where it can be raised on a lift.
- Never start or run the engine while the vehicle is on a jack.
- The jack is designed to be used as a tool for changing tires only. The jack should not be used to lift the vehicle for service purposes. The vehicle should be jacked on a firm level surface only. Avoid ice or slippery areas.

## PREPARATIONS FOR JACKING

- Park the vehicle on a firm, level surface as far from the edge of the roadway as possible. Avoid icy or slippery areas.

### WARNING!

Do not attempt to change a tire on the side of the vehicle close to moving traffic, pull far enough off the road to avoid being hit when operating the jack or changing the wheel.

- Turn on the Hazard Warning Flashers.
- Apply the parking brake.
- Place the gear selector into PARK (automatic transmission) or FIRST gear (manual transmission).
- Turn the ignition OFF.
- Block both the front and rear of the wheel diagonally opposite the jacking position. For example, if the driver's front wheel is being changed, block the passenger's rear wheel.

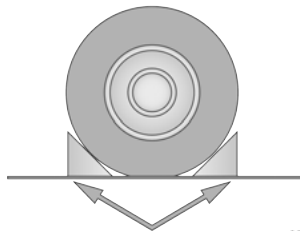

Wheel Blocked

A0707000523US

### NOTE:

Passengers should not remain in the vehicle when the vehicle is being lifted or raised.

## JACK LOCATION/SPARE TIRE STOWAGE

The jack and spare tire are both stowed under an access cover in the trunk. Follow these steps to access the jack and spare tire.

### NOTE:

The spare tire must be removed in order to access the jack.

- Open the trunk.
- Lift the access cover using the pull strap.
- Rotate the fastener securing the spare tire counterclockwise to remove it.

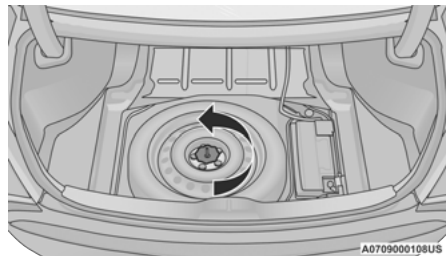

Removing Tire Fastener

A0709000108US



4. Remove the spare tire.
5. Rotate the fastener securing the jack counter-clockwise to remove it.

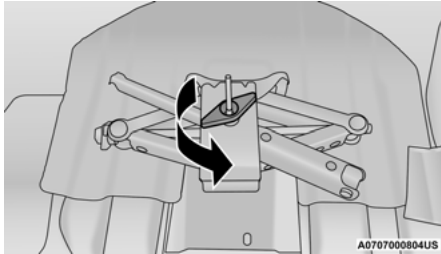

**Removing Jack Fastener**

6. Remove the jack and lug wrench assembly from under the spare tire. Turn the jack screw to the left to loosen the lug wrench, and remove the wrench from the jack assembly.

#### WARNING!

A loose tire or jack thrown forward in a collision or hard stop could endanger the occupants of the vehicle. Always stow the jack parts and the spare tire in the places provided. Have the deflated (flat) tire repaired or replaced immediately.

## JACKING AND CHANGING A TIRE

#### WARNING!

Carefully follow these tire changing warnings to help prevent personal injury or damage to your vehicle:

- Always park on a firm, level surface as far from the edge of the roadway as possible before raising the vehicle.
- Turn on the Hazard Warning Flashers.
- Apply the parking brake firmly and place an automatic transmission in PARK; a manual transmission in REVERSE or FIRST gear.
- Block the wheel diagonally opposite the wheel to be raised.
- Never start or run the engine with the vehicle on a jack.
- Do not let anyone sit in the vehicle when it is on a jack.

*(Continued)*

#### WARNING!

- Do not get under the vehicle when it is on a jack. If you need to get under a raised vehicle, take it to a service center where it can be raised on a lift.
- Only use the jack in the positions indicated and for lifting this vehicle during a tire change.
- If working on or near a roadway, be extremely careful of motor traffic.



060600714

**Jack Warning Label**

Placement for the front and rear jacking locations are critical. See the following images for proper jacking locations.

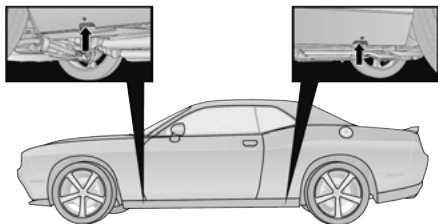

A0707000821US

**Jack Engagement Locations**

**CAUTION!**

Do not attempt to raise the vehicle by jacking on locations other than those indicated in the Jacking Instructions for this vehicle.

1. Remove the spare tire, jack, and lug wrench.

**NOTE:**

When the following label is present, the spare tire must be used for the rear wheel(s) only. For a flat front tire, you must first install the spare on one of the rear tires.

Then, follow the jacking instructions for front tire replacement and replace the front road wheel with the wheel removed from the rear of the vehicle.

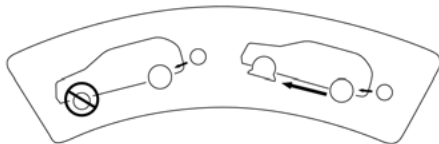

0605001489

**Spare Tire Label**

2. If equipped with aluminum wheels where the center cap covers the lug nuts, use the lug wrench to pry the center cap off carefully before raising the vehicle.
3. Before raising the vehicle, use the lug wrench to loosen, but not remove, the lug nuts on the wheel with the flat tire. Turn the lug nuts counterclockwise one turn while the wheel is still on the ground.
4. Place the jack underneath the lift area that is closest to the flat tire. Turn the jack screw clockwise to firmly engage the jack saddle with the lift area of the sill flange.

**NOTE:**

If the vehicle is too low for jack placement, slide the jack on its side and rotate it up into position.

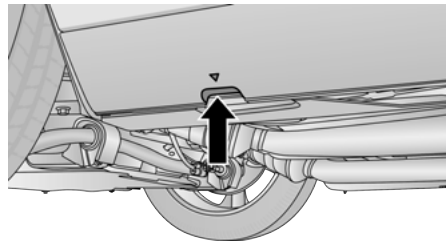

A0707000822US

**Front Lifting Point**

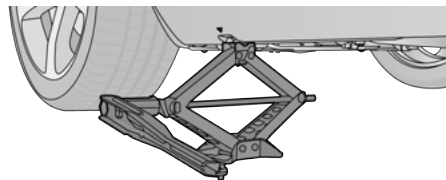

A0707000823US

**Front Jacking Location**

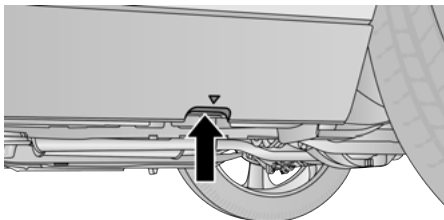

A0707000824US

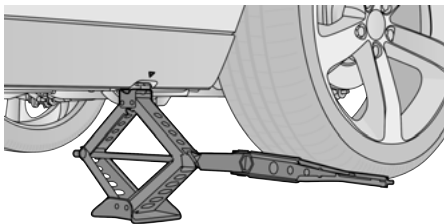
**Rear Lifting Point**

A0707000825US

**Rear Jacking Location**

5. Raise the vehicle just enough to remove the flat tire and install the spare tire.

**WARNING!**

Raising the vehicle higher than necessary can make the vehicle less stable. It could slip off the jack and hurt someone near it. Raise the vehicle only enough to remove the tire.

6. Remove the lug nuts and tire.
7. Mount the spare tire.

**CAUTION!**

Be sure to mount the spare tire with the valve stem facing outward. The vehicle could be damaged if the spare tire is mounted incorrectly.

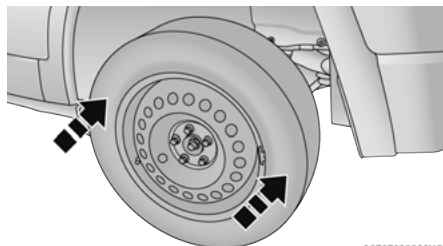

A0707000666US

**Mounting Spare Tire****NOTE:**

For vehicles so equipped, do not attempt to install a center cap or wheel cover on the compact spare  page 298.

8. Install the lug nuts with the cone shaped end of the lug nut toward the wheel. Lightly tighten the lug nuts.

**WARNING!**

To avoid the risk of forcing the vehicle off the jack, do not tighten the wheel nuts fully until the vehicle has been lowered. Failure to follow this warning may result in serious injury.

9. Lower the vehicle to the ground by turning the jack handle counterclockwise.
10. Finish tightening the wheel bolts. Push down on the wrench while at the end of the handle for increased leverage. Tighten the wheel bolts in a star pattern until each wheel bolt has been tightened twice  page 307. If in doubt about the correct tightness, have them checked with a torque wrench by an authorized dealer or at a service station.

11. Stow the jack, tools and flat tire. Make sure the base of the jack faces the front of the vehicle before tightening down the fastener.

**WARNING!**

A loose tire or jack thrown forward in a collision or hard stop could endanger the occupants of the vehicle. Always stow the jack parts and the spare tire in the places provided. Have the deflated (flat) tire repaired or replaced immediately.

**TIRE SERVICE KIT — IF EQUIPPED**

Small punctures up to 1/4 inch (6 mm) in the tire tread can be sealed with Tire Service Kit. Foreign objects (e.g., screws or nails) should not be removed from the tire. Tire Service Kit can be used in outside temperatures down to approximately -4°F (-20°C).

This kit will provide a temporary tire seal, allowing you to drive your vehicle up to 100 miles (160 km) with a maximum speed of 50 mph (80 km/h).

**TIRE SERVICE KIT STORAGE**

The Tire Service Kit is located in the trunk.

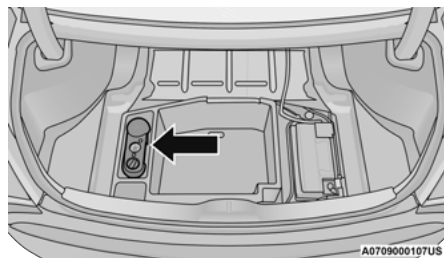

**Tire Service Kit Location**

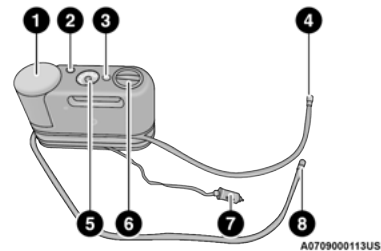
**TIRE SERVICE KIT COMPONENTS AND OPERATION**

**Tire Service Kit Components**

- 1 — Sealant Bottle
- 2 — Deflation Button
- 3 — Power Button
- 4 — Sealant Hose (Clear)
- 5 — Pressure Gauge
- 6 — Mode Select Knob
- 7 — Power Plug (located on the bottom side of the Tire Service Kit)
- 8 — Air Pump Hose (Black)

## Using The Mode Select Knob And Hoses

Your Tire Service Kit is equipped with the following symbols to indicate the air or sealant mode.

### ● Selecting Air Mode



Push in the Mode Select Knob (6) and turn to this position for air pump operation only. Use the Black Air Pump Hose (8) when selecting this mode.

### ● Selecting Sealant Mode



Push in the Mode Select Knob (6) and turn to this position to inject the Tire Service Kit Sealant and to inflate the tire. Use the Sealant Hose (clear hose) (4) when selecting this mode.

### ● Using The Power Button



Push and release the Power Button (3) once to turn on the Tire Service Kit. Push and release the Power Button (3) again to turn Off the Tire Service Kit.

### ● Using The Deflation Button



Push the Deflation Button (2) to reduce the air pressure in the tire if it becomes overinflated.

## TIRE SERVICE KIT USAGE PRECAUTIONS

- Replace the Tire Service Kit Sealant Bottle (1) and Sealant Hose (4) prior to the expiration date (printed at the upper left hand corner on the bottle label) to assure optimum operation of the system → page 243.



A0709000116US

### Tire Service Kit Expiration Date Location

- The Sealant Bottle (1) and Sealant Hose (4) are a one tire application use and need to be replaced after each use. Always replace these components immediately at your original equipment vehicle dealer.

- When the Tire Service Kit sealant is in a liquid form, clean water and a damp cloth will remove the material from the vehicle or tire and wheel components. Once the sealant dries, it can easily be peeled off and properly discarded.
- For optimum performance, make sure the valve stem on the wheel is free of debris before connecting the Tire Service Kit.
- You can use the Tire Service Kit air pump to inflate bicycle tires. The kit also comes with two needles, located in the Accessory Storage Compartment (on the bottom of the air pump) for inflating sport balls, rafts, or similar inflatable items. However, use only the Air Pump Hose (8) and make sure the Mode Select Knob (6) is in the Air Mode when inflating such items to avoid injecting sealant into them. The Tire Service Kit Sealant is only intended to seal punctures less than 1/4 inch (6 mm) diameter in the tread of your tire.
- Do not lift or carry the Tire Service Kit by the hoses.

**WARNING!**

- Do not attempt to seal a tire on the side of the vehicle closest to traffic. Pull far enough off the road to avoid the danger of being hit when using the Tire Service Kit.
- Do not use Tire Service Kit or drive the vehicle under the following circumstances:
  - If the puncture in the tire tread is approximately 1/4 inch (6 mm) or larger.
  - If the tire has any sidewall damage.
  - If the tire has any damage from driving with extremely low tire pressure.
  - If the tire has any damage from driving on a flat tire.
  - If the wheel has any damage.
  - If you are unsure of the condition of the tire or the wheel.
- Keep Tire Service Kit away from open flames or heat source.

*(Continued)*

**WARNING!**

- A loose Tire Service Kit thrown forward in a collision or hard stop could endanger the occupants of the vehicle. Always stow the Tire Service Kit in the place provided. Failure to follow these warnings can result in injuries that are serious or fatal to you, your passengers, and others around you.
- Take care not to allow the contents of Tire Service Kit to come in contact with hair, eyes, or clothing. Tire Service Kit sealant is harmful if inhaled, swallowed, or absorbed through the skin. It causes skin, eye, and respiratory irritation. Flush immediately with plenty of water if there is any contact with eyes or skin. Change clothing as soon as possible, if there is any contact with clothing.
- Tire Service Kit Sealant solution contains latex. In case of an allergic reaction or rash, consult a physician immediately. Keep Tire Service Kit out of reach of children. If swallowed, rinse mouth immediately with plenty of water and drink plenty of water. Do not induce vomiting! Consult a physician immediately.

**SEALING A TIRE WITH TIRE SERVICE KIT****(A) Whenever You Stop To Use Tire Service Kit:**

1. Pull over to a safe location and turn on the vehicle's Hazard Warning Flashers.
2. Verify that the valve stem (on the wheel with the deflated tire) is in a position that is near to the ground. This will allow the Tire Service Kit Hoses (4) and (8) to reach the valve stem and keep the Tire Service Kit flat on the ground. This will provide the best positioning of the kit when injecting the sealant into the deflated tire and running the air pump. Move the vehicle as necessary to place the valve stem in this position before proceeding.
3. Place the transmission in PARK (auto transmission) or in Gear (manual transmission) and place the ignition in the OFF position.
4. Apply the parking brake.

**(B) Setting Up To Use Tire Service Kit:**

1. Push in the Mode Select Knob (6) and turn to the Sealant Mode position.
2. Uncoil the Sealant Hose (4) and then remove the cap from the fitting at the end of the hose.
3. Place the Tire Service Kit flat on the ground next to the deflated tire.
4. Remove the cap from the valve stem and then screw the fitting at the end of the Sealant Hose (4) onto the valve stem.
5. Uncoil the Power Plug (7) and insert the plug into the vehicle's 12 Volt power outlet.

**NOTE:**

Do not remove foreign objects (e.g., screws or nails) from the tire.

**(C) Injecting Tire Service Kit Sealant Into The Deflated Tire:**

- Always start the engine before turning ON the Tire Service Kit.

**NOTE:**

Manual transmission vehicles must have the parking brake engaged and the gear selector in NEUTRAL.

- After pushing the Power Button (3), the sealant (white fluid) will flow from the Sealant Bottle (1) through the Sealant Hose (4) and into the tire.

**NOTE:**

Sealant may leak out through the puncture in the tire.

**If the sealant (white fluid) does not flow within 0 – 10 seconds through the Sealant Hose :**

1. Push the Power Button (3) to turn Off the Tire Service Kit. Disconnect the Sealant Hose (4) from the valve stem. Make sure the valve stem is free of debris. Reconnect the Sealant Hose (4) to the valve stem. Check that the Mode Select Knob (6) is in the Sealant Mode position and not Air Mode. Push the Power Button (3) to turn On the Tire Service Kit.
2. Connect the Power Plug (7) to a different 12 Volt power outlet in your vehicle or another vehicle, if available. Make sure the engine is running before turning ON the Tire Service Kit.
3. The Sealant Bottle (1) may be empty due to previous use. Call for assistance.

**NOTE:**

If the Mode Select Knob (6) is on Air Mode and the pump is operating, air will dispense from the Air Pump Hose (8) only, not the Sealant Hose (4).

**If the sealant (white fluid) does flow through the Sealant Hose :**

1. Continue to operate the pump until sealant is no longer flowing through the hose (typically takes 30 - 70 seconds). As the sealant flows through the Sealant Hose (4), the Pressure Gauge (5) can read as high as 70 psi (4.8 Bar). The Pressure Gauge (5) will decrease quickly from approximately 70 psi (4.8 Bar) to the actual tire pressure when the Sealant Bottle (1) is empty.
2. The pump will start to inject air into the tire immediately after the Sealant Bottle (1) is empty. Continue to operate the pump and inflate the tire to the pressure indicated on the tire pressure label on the driver-side latch pillar (recommended pressure). Check the tire pressure by looking at the Pressure Gauge (5).

**If the tire does not inflate to at least 26 psi (1.8 Bar) pressure within 15 minutes:**

- The tire is too badly damaged. Do not attempt to drive the vehicle further. Call for assistance.

**NOTE:**

If the tire becomes overinflated, push the Deflation Button (2) to reduce the tire pressure to the recommended inflation pressure before continuing.

**If the tire inflates to the recommended pressure or is at least 26 psi (1.8 Bar) pressure within 15 minutes:**

1. Push the Power Button (3) to turn off the Tire Service Kit.
2. Remove the Speed Limit sticker from the top of the Sealant Bottle (1) and place the sticker on the instrument panel.
3. Immediately disconnect the Sealant Hose (4) from the valve stem, reinstall the cap on the fitting at the end of the hose, and place the Tire Service Kit in the vehicle storage location.

#### CAUTION!

- The metal end fitting from Power Plug (7) may get hot after use, so it should be handled carefully.
- Failure to reinstall the cap on the fitting at the end of the Sealant Hose (4) can result in sealant contacting your skin, clothing, and the vehicle's interior. It can also result in sealant contacting internal Tire Service Kit components which may cause permanent damage to the kit.

#### (D) Drive Vehicle:

Immediately after injecting sealant and inflating the tire, drive the vehicle 5 miles (8 km) or 10 minutes to ensure distribution of the Tire Service Kit Sealant within the tire. Do not exceed 50 mph (80 km/h).

#### WARNING!

Tire Service Kit is not a permanent flat tire repair. Have the tire inspected and repaired or replaced after using Tire Service Kit. Do not exceed 50 mph (80 km/h) until the tire is repaired or replaced. Failure to follow this warning can result in injuries that are serious or fatal to you, your passengers, and others around you.

#### (E) After Driving:

Pull over to a safe location before continuing  
 ☞ page 240.

1. Push in the Mode Select Knob (6) and turn to the Air Mode position.
2. Uncoil the power plug and insert the plug into the vehicle's 12 Volt power outlet.

3. Uncoil the Air Pump Hose (8) (black in color) and screw the fitting at the end of hose on to the valve stem.
4. Check the pressure in the tire by reading the Pressure Gauge (5).

#### If tire pressure is less than 19 psi (1.3 Bar):

The tire is too badly damaged. Do not attempt to drive the vehicle further. Call for assistance.

#### If the tire pressure is 19 psi (1.3 Bar) or higher:

1. Push the Power Button (3) to turn on Tire Service Kit and inflate the tire to the pressure indicated on the tire and loading information label on the driver-side door opening.

#### NOTE:

If the tire becomes overinflated, push the Deflation Button (2) to reduce the tire pressure to the recommended inflation pressure before continuing.

2. Disconnect the Tire Service Kit from the valve stem, reinstall the cap on the valve stem and unplug from 12 Volt outlet.
3. Place the Tire Service Kit in its proper storage area in the vehicle.



4. Have the tire inspected and repaired or replaced at the earliest opportunity at an authorized dealer or tire service center.
  5. Remove the Speed Limit sticker from the instrument panel after the tire has been repaired.
  6. Replace the Sealant Bottle (1) and Sealant Hose (4) assembly at an authorized dealer as soon as possible.
5. Position the new Sealant Bottle (1) in the housing so that the Sealant Hose (4) aligns with the hose slot in the front of the housing. Push the bottle into the housing. An audible click will be heard indicating the bottle is locked into place.
  6. Verify that the cap is installed on the fitting at the end of the Sealant Hose (4) and return the hose to its storage area (located on the bottom of the air pump).
  7. Return the Tire Service Kit to its storage location in the vehicle.

**NOTE:**

When having the tire serviced, advise the authorized dealer or service center that the tire has been sealed using the Tire Service Kit.

**(F) Sealant Bottle And Hose Replacement:**

1. Uncoil the Sealant Hose (4) (clear in color).
2. Locate the round Sealant Bottle release button in the recessed area under the sealant bottle.
3. Push the Sealant Bottle release button. The Sealant Bottle (1) will pop up. Remove the bottle and dispose of it accordingly.
4. Clean any remaining sealant from the Tire Service Kit housing.

**JUMP STARTING**

If your vehicle has a discharged battery, it can be jump started using a set of jumper cables and a battery in another vehicle, or by using a portable battery booster pack. Jump starting can be dangerous if done improperly, so please follow the procedures in this section carefully.

**WARNING!**

Do not attempt jump starting if the battery is frozen. It could rupture or explode and cause personal injury.

**CAUTION!**

Do not use a portable battery booster pack or any other booster source with a system voltage greater than 12 Volts or damage to the battery, starter motor, alternator or electrical system may occur.

**NOTE:**

When using a portable battery booster pack, follow the manufacturer's operating instructions and precautions.

## PREPARATIONS FOR JUMP START

The battery is stored under an access cover in the trunk. Remote battery posts are located on the right side of the engine compartment for jump starting.

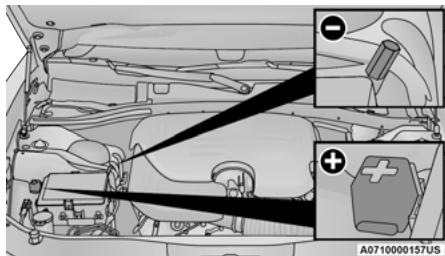

**Jump Starting Locations**

Remote Negative (-) Post

Remote Positive (+) Post

### NOTE:

The remote battery posts are viewed by standing on the right side of the vehicle looking over the fender. The positive battery post may be covered with a protective cap. Lift up on the cap to gain access to the positive battery post. Do not jump off fuses. Only jump directly off positive post which has a positive (+) symbol on or around the post.

See the following steps to prepare for jump starting:

1. Apply the parking brake, shift into PARK (automatic transmission) or FIRST gear (manual transmission) and cycle the ignition to OFF.
2. Turn off the heater, radio, and all electrical accessories.
3. Pull upward and remove the protective cover over the remote positive (+) battery post.
4. If using another vehicle to jump start the battery, park the vehicle within the jumper cables reach, apply the parking brake and make sure the ignition is OFF.

### WARNING!

Do not allow vehicles to touch each other as this could establish a ground connection and personal injury could result.

### WARNING!

- Take care to avoid the radiator cooling fan whenever the hood is raised. It can start anytime the ignition switch is ON. You can be injured by moving fan blades.

*(Continued)*

### WARNING!

- Remove any metal jewelry such as rings, watch bands and bracelets that could make an inadvertent electrical contact. You could be seriously injured.
- Batteries contain sulfuric acid that can burn your skin or eyes and generate hydrogen gas which is flammable and explosive. Keep open flames or sparks away from the battery.

## JUMP STARTING PROCEDURE

### WARNING!

Failure to follow this jump starting procedure could result in personal injury or property damage due to battery explosion.

### CAUTION!

Failure to follow these procedures could result in damage to the charging system of the booster vehicle or the discharged vehicle.

1. Connect the positive (+) end of the jumper cable to the remote positive (+) post of the vehicle with the discharged battery.
2. Connect the opposite end of the positive (+) jumper cable to the positive (+) post of the booster battery.
3. Connect the negative (-) end of the jumper cable to the negative (-) post of the booster battery.
4. Connect the opposite end of the negative (-) jumper cable to the remote negative (-) post (exposed metallic/unpainted post of the discharge vehicle) located directly behind the under-hood fuse box.

**WARNING!**

Do not connect the jumper cable to the negative (-) post of the discharged battery. The resulting electrical spark could cause the battery to explode and could result in personal injury.

5. Start the engine in the vehicle that has the booster battery, let the engine idle a few minutes, and then start the engine in the vehicle with the discharged battery.

**CAUTION!**

Do not run the booster vehicle engine above 2,000 RPM since it provides no charging benefit, wastes fuel, and can damage booster vehicle engine.

6. Once the engine is started, follow the disconnection procedure.

**Disconnecting The Jumper Cables**

1. Disconnect the negative (-) end of the jumper cable from the remote negative (-) post of the vehicle with the discharged battery.
2. Disconnect the opposite end of the negative (-) jumper cable from the negative (-) post of the booster battery.
3. Disconnect the positive (+) end of the jumper cable from the positive (+) post of the booster battery.
4. Disconnect the opposite end of the positive (+) jumper cable from the remote positive (+) post of the vehicle with the discharged battery.

If frequent jump starting is required to start your vehicle you should have the battery and charging system inspected at an authorized dealer.

**CAUTION!**

Accessories plugged into the vehicle power outlets draw power from the vehicle's battery, even when not in use (i.e., cellular devices, etc.). Eventually, if plugged in long enough without engine operation, the vehicle's battery will discharge sufficiently to degrade battery life and/or prevent the engine from starting.

**IF YOUR ENGINE OVERHEATS**

If the vehicle is overheating, it will need to be serviced by an authorized dealer.

In any of the following situations, you can reduce the potential for overheating by taking the appropriate action.

- On the highways — slow down.
- In city traffic — while stopped, place the transmission in NEUTRAL, but do not increase the engine idle speed while preventing vehicle motion with the brakes.

**NOTE:**

There are steps that you can take to slow down an impending overheat condition:

- If your Air Conditioner (A/C) is on, turn it off. The A/C system adds heat to the engine cooling system and turning the A/C off can help remove this heat.
- You can also turn the temperature control to maximum heat, the mode control to floor and the blower control to high. This allows the heater core to act as a supplement to the radiator and aids in removing heat from the engine cooling system.

**WARNING!**

You or others can be badly burned by hot engine coolant (antifreeze) or steam from your radiator. If you see or hear steam coming from under the hood, do not open the hood until the radiator has had time to cool. Never try to open a cooling system pressure cap when the radiator or coolant bottle is hot.

**CAUTION!**

Driving with a hot cooling system could damage your vehicle. If the temperature gauge reads HOT (H), pull over and stop the vehicle. Idle the vehicle with the air conditioner turned off until the pointer drops back into the normal range. If the pointer remains on HOT (H), and you hear continuous chimes, turn the engine off immediately and call for service.

**MANUAL PARK RELEASE – 8 – SPEED TRANSMISSION****WARNING!**

Always secure your vehicle by fully applying the parking brake before activating the Manual Park Release. In addition, you should be seated in the driver's seat with your foot firmly on the brake pedal when activating the Manual Park Release. Activating the Manual Park Release will allow your vehicle to roll away if it is not secured by the parking brake, or by proper connection to a tow vehicle. Activating the Manual Park Release on an unsecured vehicle could lead to serious injury or death for those in or around the vehicle.

In order to move the vehicle in cases where the transmission will not shift out of PARK (P) (such as a depleted battery), a Manual Park Release is available.

Follow these steps to use the Manual Park Release:

1. Firmly apply the parking brake.
2. Remove the console storage bin to access the Manual Park Release lever.

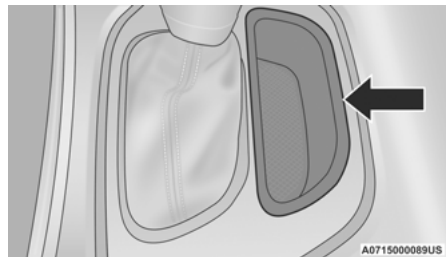

**Console Storage Bin**

- Using a small screwdriver or similar tool, fish the tether strap up through the opening in the console base.
- Press and maintain firm pressure on the brake pedal.
- Insert the screwdriver into the slot in the center of the lever, and disengage the lever locking tab by pushing it to the right.
- Pull the tether strap to rotate the lever up and rearward until it locks in place in the vertical position. The vehicle is now out of PARK and can be moved. Release the parking brake only when the vehicle is securely connected to a tow vehicle.

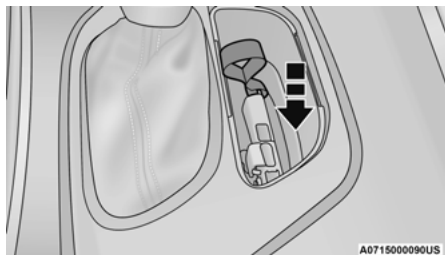

Engaging The Lever

#### To Reset The Manual Park Release:

- Push the latch (at the base of the lever, on the rear side) rearward (away from the lever) to unlatch the lever.

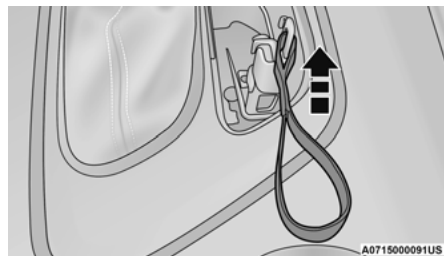

Disengaging The Lever

- Rotate the Manual Park Release lever forward and down, to its original position, until the locking tab snaps into place to secure the lever.
- Pull up gently on the tether strap to confirm that the lever is locked in its stowed position.
- Tuck the tether strap into the base of the console. Reinstall the console storage bin.

#### NOTE:

When the lever is in the release position the access cover cannot be reinstalled.

## FREEDING A STUCK VEHICLE

If your vehicle becomes stuck in mud, sand, or snow, it can often be moved using a rocking motion. Turn the steering wheel right and left to clear the area around the front wheels.

For vehicles with automatic transmission, push and hold the lock button on the gear selector. Then shift back and forth between DRIVE and REVERSE (with automatic transmission) or FIRST gear and REVERSE (with manual transmission), while gently pressing the accelerator. Use the least amount of accelerator pedal pressure that will maintain the rocking motion, without spinning the wheels or racing the engine.

### CAUTION!

Racing the engine or spinning the wheels may lead to transmission overheating and failure. Allow the engine to idle with the transmission in NEUTRAL for at least one minute after every five rocking-motion cycles. This will minimize overheating and reduce the risk of clutch or transmission failure during prolonged efforts to free a stuck vehicle.

### NOTE:

For vehicles with automatic transmission: Shifts between DRIVE and REVERSE can only be achieved at wheel speeds of 5 mph (8 km/h) or less. Whenever the transmission remains in NEUTRAL for more than two seconds, you must press the brake pedal to engage DRIVE or REVERSE.

Push the ESC OFF button to place the Electronic Stability Control (ESC) system in "Partial OFF" mode, before rocking the vehicle → page 181. Once the vehicle has been freed, push the ESC OFF button again to restore "ESC On" mode.

### WARNING!

Fast spinning tires can be dangerous. Forces generated by excessive wheel speeds may cause damage, or even failure, of the axle and tires. A tire could explode and injure someone. Do not spin your vehicle's wheels faster than 30 mph (48 km/h) or for longer than 30 seconds continuously without stopping when you are stuck and do not let anyone near a spinning wheel, no matter what the speed.

### CAUTION!

- When "rocking" a stuck vehicle by shifting between DRIVE / FIRST gear and REVERSE, do not spin the wheels faster than 15 mph (24 km/h), or drivetrain damage may result.
- Revving the engine or spinning the wheels too fast may lead to transmission overheating and failure. It can also damage the tires. Do not spin the wheels above 30 mph (48 km/h) while in gear (no transmission shifting occurring).

## TOWING A DISABLED VEHICLE

This section describes procedures for towing a disabled vehicle using a commercial towing service.

Towing Condition	Wheels OFF The Ground	RWD MODELS	AWD MODELS
Flat Tow	NONE	<b>If transmission is operable:</b> <ul style="list-style-type: none"> <li>• Transmission in <b>NEUTRAL</b></li> <li>• 30 mph (48 km/h) <b>max</b> speed</li> <li>• 30 miles (48 km) <b>max</b> distance</li> </ul>	<b>NOT ALLOWED</b>
Wheel Lift Or Dolly Tow	Front	<b>NOT RECOMMENDED (but, if used, same limitations as previously mentioned)</b>	<b>NOT ALLOWED</b>
	Rear	NOT RECOMMENDED	NOT RECOMMENDED, but, if used: <ul style="list-style-type: none"> <li>• Ignition in ON/RUN mode</li> <li>• Transmission in <b>NEUTRAL (NOT in PARK)</b></li> </ul>
Flatbed	<b>ALL</b>	<b>BEST METHOD</b>	<b>BEST METHOD</b>

Proper towing or lifting equipment is required to prevent damage to your vehicle. Use only tow bars and other equipment designed for this purpose, following equipment manufacturer's instructions. Use of safety chains is mandatory. Attach a tow bar or other towing device to main structural members of the vehicle, not to fascia/bumpers or associated brackets. State and local laws regarding vehicles under tow must be observed.

If you must use the accessories (wipers, defrosters, etc.) while being towed, the ignition must be in the ON/RUN mode, not the ACC mode.

If the key fob is unavailable or the vehicle's battery is discharged, find Instructions on shifting the transmission out of PARK ↪ page 246.

**CAUTION!**

- Do not use sling type equipment when towing. Vehicle damage may occur.
- When securing the vehicle to a flat bed truck, do not attach to front or rear suspension components. Damage to your vehicle may result from improper towing.
- FCA US LLC does not recommend towing this vehicle using a tow dolly. Vehicle damage may occur.

**REAR-WHEEL DRIVE (RWD) MODELS**

FCA US LLC recommends towing your vehicle with all four wheels **OFF** the ground using a flatbed.

If flatbed equipment is not available, and the transmission is operable, the vehicle may be flat towed (with all four wheels on the ground) under the following conditions:

- The transmission must be in NEUTRAL (N). Instructions on shifting the transmission to NEUTRAL (N) when the engine is off ⇨ page 246.
- The towing distance must not exceed 30 miles (48 km).
- The towing speed must not exceed 30 mph (48 km/h).

If the transmission is not operable, or the vehicle must be towed faster than 30 mph (48 km/h) or farther than 30 miles (48 km), then the only acceptable method of towing is with a flatbed truck.

**CAUTION!**

Towing this vehicle in violation of the previously mentioned requirements can cause severe engine and/or transmission damage. Damage from improper towing is not covered under the New Vehicle Limited Warranty.

**ENHANCED ACCIDENT RESPONSE SYSTEM (EARS)**

This vehicle is equipped with an Enhanced Accident Response System.

This feature is a communication network that takes effect in the event of an impact ⇨ page 209.

**EVENT DATA RECORDER (EDR)**

This vehicle is equipped with an event data recorder (EDR). The main purpose of an EDR is to record data that will assist in understanding how a vehicle's systems performed under certain crash or near crash-like situations, such as an air bag deployment or hitting a road obstacle ⇨ page 210.



# SERVICING AND MAINTENANCE

## SCHEDULED SERVICING

### 3.6L AND 5.7L ENGINES

These engines are equipped with an automatic oil change indicator system. The oil change indicator system will remind you that it is time to take your vehicle in for scheduled maintenance.

Based on engine operation conditions, the oil change indicator message will illuminate. This means that service is required for the vehicle. Operating conditions such as frequent short-trips, trailer tow, and extremely hot or cold ambient temperatures will influence when the “Change Oil” or “Oil Change Required” message is displayed. Have your vehicle serviced as soon as possible, within the next 500 miles (805 km).

The “Oil Change Required” message will be displayed in the instrument cluster and a single chime will sound, indicating that an oil change is necessary.

An authorized dealer will reset the oil change indicator message after completing the scheduled oil change.

#### NOTE:

Under no circumstances should oil change intervals exceed 10,000 miles (16,000 km), 12 months or 350 hours of engine run time, whichever comes first. The 350 hours of engine run or idle time is generally only a concern for fleet customers.

#### Once A Month Or Before A Long Trip:

- Check engine oil level.
- Check windshield washer fluid level.
- Check tire pressure and look for unusual wear or damage. Rotate tires at the first sign of irregular wear, even if it occurs before your next scheduled service.
- Check the fluid levels of the coolant reservoir, brake master cylinder, and power steering (if equipped) and fill as needed.
- Check function of all interior and exterior lights.

## Maintenance Plan — 3.6L And 5.7L

Refer to the maintenance chart for the required maintenance intervals.

At Every Oil Change Interval As Indicated By Oil Change Indicator System:
● Change oil and filter
● Rotate the tires. <b>Rotate at the first sign of irregular wear, even if it occurs before your next scheduled service</b>
● Inspect battery and clean and tighten terminals as required
● Inspect the CV/Universal joints
● Inspect brake pads, shoes, rotors, drums, hoses and parking brake
● Inspect engine cooling system protection and hoses
● Inspect exhaust system
● Inspect engine air cleaner filter if using in dusty or off-road conditions, replace engine air cleaner filter if necessary

Mileage or time passed (whichever comes first)	20,000	30,000	40,000	50,000	60,000	70,000	80,000	90,000	100,000	110,000	120,000	130,000	140,000	150,000
Or Years:	2	3	4	5	6	7	8	9	10	11	12	13	14	15
Or Kilometers:	32,000	48,000	64,000	80,000	96,000	112,000	128,000	144,000	160,000	176,000	192,000	208,000	224,000	240,000
<b>Additional Inspections</b>														
Inspect the CV/Universal joints.	X	X	X	X	X	X	X	X	X	X	X	X	X	X
Inspect front suspension, tie rod ends, boot seals and replace if necessary.	X		X		X		X		X		X		X	
Inspect the rear axle fluid. Inspect the front axle fluid (All Wheel Drive Only).	X		X		X		X		X		X		X	
Inspect the manual transmission fluid (if equipped).	X		X		X		X		X		X		X	
Inspect the brake linings, replace as necessary.	X		X		X		X		X		X		X	
Adjust parking brake on vehicles equipped with four wheel disc brakes.	X		X		X		X		X		X		X	
Inspect transfer case fluid (All Wheel Drive Only).		X			X			X			X			X
<b>Additional Maintenance</b>														
Replace engine air cleaner filter.		X			X			X			X			X
Replace cabin air filter.	X		X		X		X		X		X		X	

Mileage or time passed (whichever comes first)	20,000	30,000	40,000	50,000	60,000	70,000	80,000	90,000	100,000	110,000	120,000	130,000	140,000	150,000
Or Years:	2	3	4	5	6	7	8	9	10	11	12	13	14	15
Or Kilometers:	32,000	48,000	64,000	80,000	96,000	112,000	128,000	144,000	160,000	176,000	192,000	208,000	224,000	240,000
Replace spark plugs. <sup>1</sup>									X					
Flush and replace the engine coolant at 10 years or 150,000 miles (240,000 km) whichever comes first.									X					X
Change the manual transmission fluid (if equipped) if using your vehicle for any of the following: Most of your driving is at sustained speeds during hot weather, above 90 ° F (32 ° C), driving in dusty conditions, or stop and go driving.				X					X					X
Change the transfer case fluid; if using your vehicle for any of the following: police, taxi, fleet, off-road, or frequent trailer towing. (All Wheel Drive Only).					X						X			

Mileage or time passed (whichever comes first)	20,000	30,000	40,000	50,000	60,000	70,000	80,000	90,000	100,000	110,000	120,000	130,000	140,000	150,000
Or Years:	2	3	4	5	6	7	8	9	10	11	12	13	14	15
Or Kilometers:	32,000	48,000	64,000	80,000	96,000	112,000	128,000	144,000	160,000	176,000	192,000	208,000	224,000	240,000
Change the rear axle fluid and on models equipped with All Wheel Drive (AWD) change the front axle fluid if using your vehicle for any of the following: police, taxi, fleet, off-road, or frequent trailer towing.				X					X					X
Inspect and replace PCV valve if necessary.									X					

1. The spark plug change interval is mileage based only, yearly intervals do not apply.

#### WARNING!

- You can be badly injured working on or around a motor vehicle. Do only service work for which you have the knowledge and the right equipment. If you have any doubt about your ability to perform a service job, take your vehicle to a competent mechanic.
- Failure to properly inspect and maintain your vehicle could result in a component malfunction and effect vehicle handling and performance. This could cause an accident.

## ENGINE COMPARTMENT

### 3.6L ENGINE

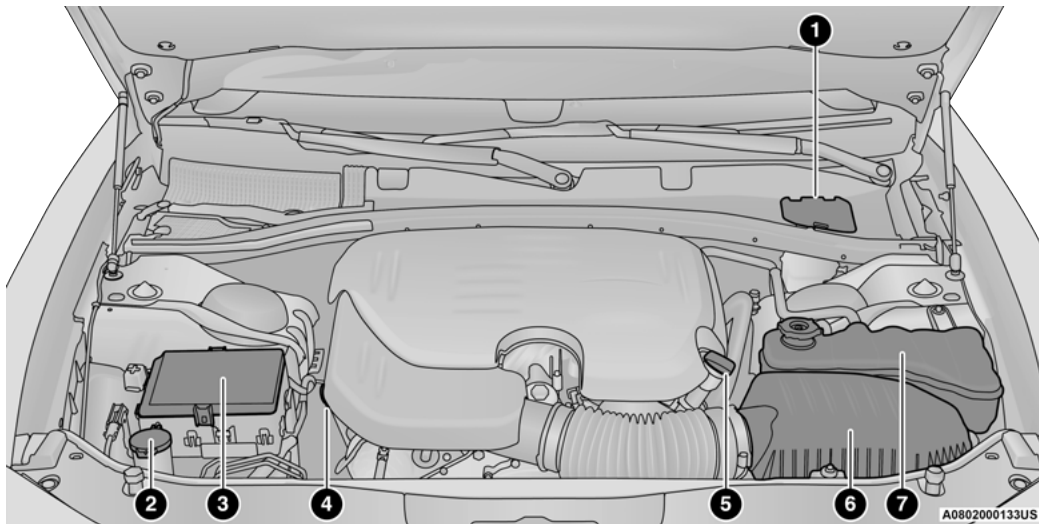

- 1 – Brake Fluid Reservoir Access Cover
- 2 – Washer Fluid Reservoir Cap
- 3 – Power Distribution Center (Fuses)
- 4 – Engine Oil Dipstick

- 5 – Engine Oil Fill
- 6 – Engine Air Cleaner Filter
- 7 – Engine Coolant Pressure Reservoir

## 5.7L ENGINE

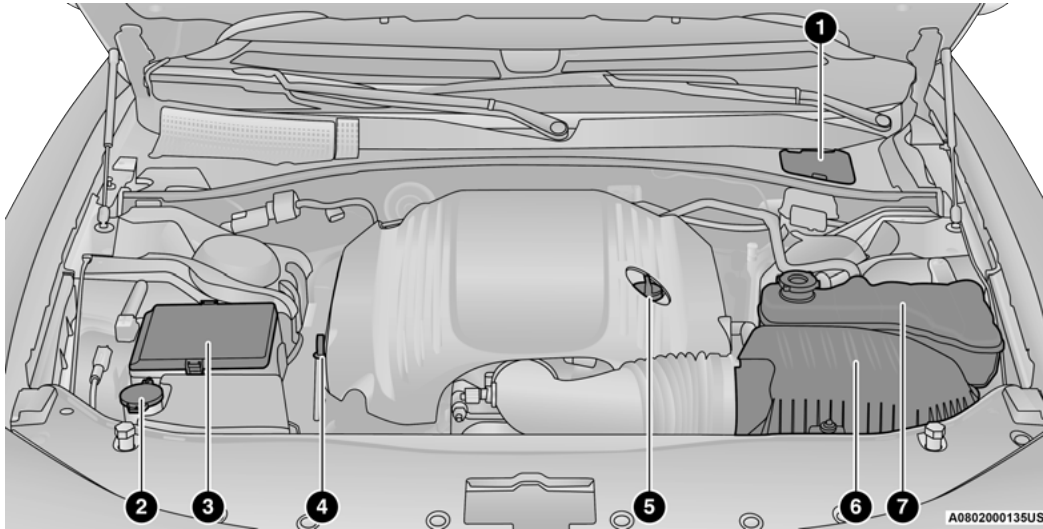

- 1 – Brake Fluid Reservoir Access Cover
- 2 – Washer Fluid Reservoir Cap
- 3 – Power Distribution Center (Fuses)
- 4 – Engine Oil Dipstick

- 5 – Engine Oil Fill
- 6 – Engine Air Cleaner Filter
- 7 – Engine Coolant Pressure Reservoir

## CHECKING OIL LEVEL

### WARNING!

- Never smoke while working in the engine compartment: gas and inflammable vapors may be present, with the risk of fire.
- Be very careful when working in the engine compartment when the engine is hot: you may get burned. Do not get too close to the radiator cooling fan: the electric fan may start; danger of injury. Scarves, ties and other loose clothing might be pulled by moving parts.

### CAUTION!

- Be careful not to confuse the various types of fluids while topping up: they are not compatible with each other! Topping up with an unsuitable fluid could severely damage your car.
- The oil level must never exceed the MAX mark.
- Always top up using engine oil of the same specifications as what is already in the engine.

*(Continued)*

### CAUTION!

- If the engine oil is being topped up, wait for the engine to cool down before loosening the filler cap, particularly for vehicles with aluminum caps (if equipped). **WARNING:** risk of burns!
- Overfilling or underfilling the crankcase will cause aeration or loss of oil pressure. This could damage your engine.

To ensure proper engine lubrication, the engine oil must be maintained at the correct level. Check the oil level at regular intervals, such as every fuel stop. The best time to check the engine oil level is about ten minutes after a fully warmed up engine is shut off.

Checking the oil while the vehicle is on level ground will improve the accuracy of the oil level readings.

There are four possible dipstick types:

- Crosshatched zone.
- Crosshatched zone marked SAFE.
- Crosshatched zone marked with MIN at the low end of the range and MAX at the high end of the range.
- Crosshatched zone marked with dimples at the MIN and the MAX ends of the range.

### NOTE:

Always maintain the oil level within the crosshatch markings on the dipstick.

Adding 1 quart (1 liter) of oil when the reading is at the low end of the dipstick range will raise the oil level to the high end of the range marking.

### CAUTION!

Overfilling or underfilling the crankcase will cause aeration or loss of oil pressure. This could damage your engine.

## ADDING WASHER FLUID

The windshield washer fluid reservoir is located in the front of the engine compartment. Be sure to check the fluid level at regular intervals. Fill the reservoir with windshield washer solvent (not radiator antifreeze) and operate the system for a few seconds to flush out the residual water.

When refilling the washer fluid reservoir, apply some washer fluid to a cloth or towel and wipe the wiper blades clean. This will help blade performance.



To prevent freeze-up of your windshield washer system in cold weather, select a solution or mixture that meets or exceeds the temperature range of your climate. This rating information can be found on most washer fluid containers.

The fluid reservoir will hold nearly 1 Gallon (4 Liters) of washer fluid when the message “Low Washer Fluid” appears in the instrument cluster.

#### WARNING!

Commercially available windshield washer solvents are flammable. They could ignite and burn you. Care must be exercised when filling or working around the washer solution.

## MAINTENANCE-FREE BATTERY

Your vehicle is equipped with a maintenance-free battery. Water will never have to be added, and periodic maintenance is not required.

#### NOTE:

The battery is stored under an access cover in the trunk. Remote battery terminals are located in the engine compartment for jump starting  
 ⇨ page 243.

#### WARNING!

- Battery fluid is a corrosive acid solution and can burn or even blind you. Do not allow battery fluid to contact your eyes, skin, or clothing. Do not lean over a battery when attaching clamps. If acid splashes in eyes or on skin, flush the area immediately with large amounts of water ⇨ page 243.
- Battery gas is flammable and explosive. Keep flame or sparks away from the battery. Do not use a booster battery or any other booster source with an output greater than 12 Volts. Do not allow cable clamps to touch each other.
- Battery posts, terminals, and related accessories contain lead and lead compounds. Wash hands after handling.
- The battery in this vehicle has a vent hose that should not be disconnected and should only be replaced with a battery of the same type (vented).

#### CAUTION!

- It is essential when replacing the cables on the battery that the positive cable is attached to the positive post and the negative cable is attached to the negative post. Battery posts are marked positive (+) and negative (-) and are identified on the battery case. Cable clamps should be tight on the terminal posts and free of corrosion.
- If a “fast charger” is used while the battery is in the vehicle, disconnect both vehicle battery cables before connecting the charger to the battery. Do not use a “fast charger” to provide starting voltage.

## PRESSURE WASHING

Cleaning the engine compartment with a high pressure washer is not recommended.

#### CAUTION!

Precautions have been taken to safeguard all parts and connections however, the pressures generated by these machines is such that complete protection against water ingress cannot be guaranteed.

## VEHICLE MAINTENANCE

An authorized dealer has the qualified service personnel, special tools, and equipment to perform all service operations in an expert manner. Service Manuals are available which include detailed service information for your vehicle. Refer to these Service Manuals before attempting any procedure yourself.

### NOTE:

Intentional tampering with emissions control systems may void your warranty and could result in civil penalties being assessed against you.

### WARNING!

You can be badly injured working on or around a motor vehicle. Only do service work for which you have the knowledge and the proper equipment. If you have any doubt about your ability to perform a service job, take your vehicle to a competent mechanic.

## ENGINE OIL

### Engine Oil Selection — 3.6L And 5.7L Engine

For best performance and maximum protection under all types of operating conditions, the manufacturer only recommends engine oils that are API Certified and meet the requirements of the manufacturer Material Standard MS-6395.

### NOTE:

Hemi engines (5.7L) at times can tick right after startup and then quiet down after approximately 30 seconds. This is normal and will not harm the engine. This characteristic can be caused by short drive cycles: for example, if the vehicle is started then shut off after driving a short distance. Upon restarting, you may experience a ticking sound. Other causes could be if the vehicle is unused for an extended period of time, incorrect oil, extended oil changes or extended idling. If the engine continues to tick or if the Malfunction Indicator Light (MIL) comes on, see the nearest authorized dealer.

### American Petroleum Institute (API) Engine Oil Identification Symbol



This symbol means that the oil has been certified by the American Petroleum Institute (API). The manufacturer only recommends API Certified engine oils.

This symbol certifies 0W-20, 5W-20, 0W-30, 5W-30 and 10W-30 engine oils.

### CAUTION!

Do not use chemical flushes in your engine oil as the chemicals can damage your engine. Such damage is not covered by the New Vehicle Limited Warranty.

### Synthetic Engine Oils

You may use synthetic engine oils provided the recommended oil quality requirements are met, and the recommended maintenance intervals for oil and filter changes are followed.

Synthetic engine oils which do not have both the engine oil certification mark and the correct SAE viscosity grade number should not be used.

## Shaker Hood — If Equipped

### Shaker Hood Oil Filler

For vehicles equipped with a Shaker Hood, the upper scoop will need to be removed so that oil can be properly added to the engine.

To do this, use the following procedure:

1. Remove the four nuts with the Shaker tool located in the glove compartment.
2. Lift off the upper scoop.

#### NOTE:

Be sure to clean off all debris around or inside of the Shaker assembly.

3. Locate the oil fill cover in base assembly to expose the oil fill cap.
4. Remove oil fill cap to add oil.
5. Reinstall Shaker assembly.

### Shaker Hood Air Filter Cleaning

1. Remove the air filter from the intake and set the filter clamp aside.
2. Measure the length of the filter media.
3. Fill a bucket with warm clean water to the depth matching the filter media measurement and add a mild household detergent or air filter cleaning solution.

4. Without allowing the solution to flow back into the inside of the air filter, submerge the filter media into the water and let it soak for ten minutes.
5. Empty the bucket filled with dirty water and repeat steps 3 and 4.
6. Refill the bucket with clean warm water and rinse the filter by rotating the filter.

#### NOTE:

The water should be clean with no signs of dirt in the bucket.

7. Allow the filter to air dry. Reinstall the filter on the intake system once it is dry.

### Shaker Hood Removal And Cleaning

1. Remove the four nuts with the Shaker tool located in glove compartment.
2. Lift off the upper scoop.

#### NOTE:

Be sure to clean off all debris around or inside of the Shaker assembly.

3. Using a water and mild detergent clean the following locations:
  - The water drain slot located at the front forward edge of the Shaker assembly.
  - The seals attached to the scoop and air box.

- Lower water drains located in the lower Shaker assembly and air box as well as the hood interface areas for the seals. Apply Mopar® Leather, Rubber & Vinyl Protectant after cleaning the seals.
4. Reinstall Shaker assembly.

## Materials Added To Engine Oil

The manufacturer strongly recommends against the addition of any additives (other than leak detection dyes) to the engine oil. Engine oil is an engineered product and its performance may be impaired by supplemental additives.

### Disposing Of Used Engine Oil And Oil Filters

Care should be taken in disposing of used engine oil and oil filters from your vehicle. Used oil and oil filters, indiscriminately discarded, can present a problem to the environment. Contact an authorized dealer, service station or governmental agency for advice on how and where used oil and oil filters can be safely discarded in your area.

## ENGINE OIL FILTER

The engine oil filter should be replaced with a new filter at every engine oil change.

### Engine Oil Filter Selection

A full-flow type disposable oil filter should be used for replacement. The quality of replacement filters varies considerably. Only high quality Mopar® certified filters should be used.

### ENGINE AIR CLEANER FILTER

For the proper maintenance intervals ⇨ page 252.

#### WARNING!

The air induction system (air cleaner, hoses, etc.) can provide a measure of protection in the case of engine backfire. Do not remove the air induction system (air cleaner, hoses, etc.) unless such removal is necessary for repair or maintenance. Make sure that no one is near the engine compartment before starting the vehicle with the air induction system (air cleaner, hoses, etc.) removed. Failure to do so can result in serious personal injury.

### Engine Air Cleaner Filter Selection

The quality of replacement filters varies considerably. Only high quality Mopar® certified filters should be used.

### T/A Air Filter Maintenance — If Equipped

#### Clean Engine Air Filter

The scheduled air filter cleaning interval is 30,000 miles (48,280 km), or if in a dusty environment the engine air filter should be checked periodically to ensure optimal air flow.

Cleaning your engine air filter with the recommended Mopar® Performance Air Filter Service Kit is not required if you can still see any part the wire screen on the entire air filter regardless of how dirty it may appear. When any part of the wire screen is no longer visible on the air filter, that is an indication it is time to clean the air filter.

1. Spray the air filter with the recommended Mopar® air filter cleaner and let sit for at least 10 minutes to loosen dirt, before rinsing.

#### NOTE:

Never use strong detergents, high pressure, or gasoline on air filter.

2. Rinse the air filter with cool low-pressure water applied from the inside (clean side) out in order to flush the dirt out of the filter. Continue to rinse the filter until all traces of the cleaner have been removed.

#### NOTE:

It may be necessary to repeat steps 1 and 2 if the air filter is not completely clean.

3. After rinsing the air filter, gently shake off the excess water and allow air filter to dry naturally. Do not apply oil until air filter is completely dry.

#### NOTE:

Do not use forced air pressure as it may damage the filtering capabilities of the filter's microfibers and also void its warranty.

4. Using the Mopar® Performance Air Filter Service Kit, spray oil evenly along the crown of each filter pleat holding the nozzle about 3 inches (76 mm) away from the air filter. One spray per 2 square inches (1,290 square mm) of air filter. With one complete coat of oil, let it wick (saturate) for about 20 minutes, and if required touch up any light areas on either side of the filter.

## AIR CONDITIONER MAINTENANCE

For best possible performance, your air conditioner should be checked and serviced by an authorized dealer at the start of each warm season. This service should include cleaning of the condenser fins and a performance test. Drive belt tension should also be checked at this time.

### WARNING!

- Use only refrigerants and compressor lubricants approved by the manufacturer for your air conditioning system. Some unapproved refrigerants are flammable and can explode, injuring you. Other unapproved refrigerants or lubricants can cause the system to fail, requiring costly repairs. Refer to Warranty Information Book, for further warranty information.
- The air conditioning system contains refrigerant under high pressure. To avoid risk of personal injury or damage to the system, adding refrigerant or any repair requiring lines to be disconnected should be done by an experienced technician.

### CAUTION!

Do not use chemical flushes in your air conditioning system as the chemicals can damage your air conditioning components. Such damage is not covered by the New Vehicle Limited Warranty.

### Refrigerant Recovery And Recycling R-134a — If Equipped

R-134a Air Conditioning Refrigerant is a hydrofluorocarbon (HFC) that is an ozone-friendly substance. The manufacturer recommends that air conditioning service be performed by an authorized dealer or other service facilities using recovery and recycling equipment.

#### NOTE:

Use only manufacturer approved A/C system PAG compressor oil and refrigerants.

### Refrigerant Recovery And Recycling R-1234yf — If Equipped

R-1234yf Air Conditioning Refrigerant is a hydrofluoroolefin (HFO) that is endorsed by the Environmental Protection Agency and is an ozone-friendly substance with a low global-warming potential. The manufacturer recommends that air conditioning service be performed by an authorized dealer using recovery and recycling equipment.

#### NOTE:

Use only manufacturer approved A/C system PAG compressor oil, and refrigerants.

### Cabin Air Filter

The filter is located in the fresh air inlet under the hood, behind a removable panel in the cowl on the passenger side of the vehicle, next to the windshield wipers. When installing a new filter, ensure its proper orientation.

1. Remove the access door in the cowl screen by pressing the retaining clips.

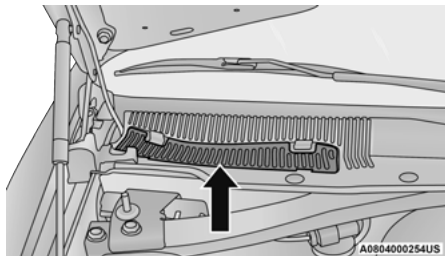

Access Door

2. Unsnap both ends and lift the filter access cover.

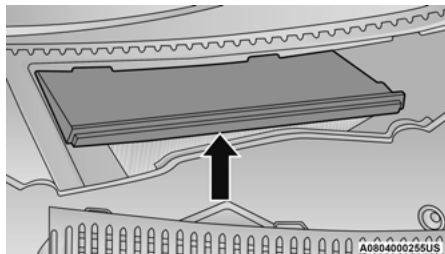

Filter Access Cover

3. Remove the used filter.
4. Install the new filter with arrows pointing in the direction of airflow, which is toward the rear of the vehicle (text and arrows on the filter will indicate this).

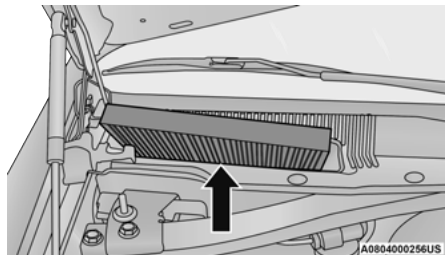

Cabin Air Filter

5. Close the filter access cover.

For the proper maintenance intervals → page 251.

## ACCESSORY DRIVE BELT INSPECTION

### WARNING!

- Do not attempt to inspect an accessory drive belt with vehicle running.
- When working near the radiator cooling fan, disconnect the fan motor lead. The fan is temperature controlled and can start at any time regardless of ignition mode. You could be injured by the moving fan blades.
- You can be badly injured working on or around a motor vehicle. Only do service work for which you have the knowledge and the proper equipment. If you have any doubt about your ability to perform a service job, take your vehicle to a competent mechanic.

When inspecting accessory drive belts, small cracks that run across ribbed surface of belt from rib to rib, are considered normal. These are not a reason to replace belt. However, cracks running along a rib (not across) are not normal. Any belt with cracks running along a rib must be replaced. Also have the belt replaced if it has excessive wear, frayed cords or severe glazing.

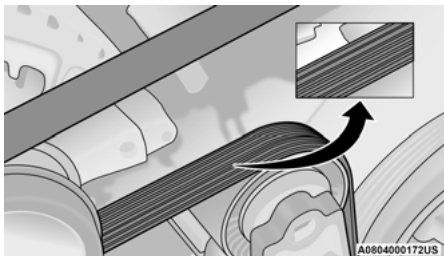

**Accessory Belt (Serpentine Belt)**

Conditions that would require replacement:

- Rib chunking (one or more ribs has separated from belt body)
- Rib or belt wear
- Longitudinal belt cracking (cracks between two ribs)
- Belt slips
- "Groove jumping" (belt does not maintain correct position on pulley)
- Belt broken (note: identify and correct problem before new belt is installed)
- Noise (objectionable squeal, squeak, or rumble is heard or felt while drive belt is in operation)

Some conditions can be caused by a faulty component such as a belt pulley. Belt pulleys should be carefully inspected for damage and proper alignment.

Belt replacement on some models requires the use of special tools, we recommend having your vehicle serviced at an authorized dealer.

## BODY LUBRICATION

Locks and all body pivot points, including such items as seat tracks, door hinge pivot points and rollers, liftgate, tailgate, decklid, sliding doors and hood hinges, should be lubricated periodically with a lithium-based grease, such as Mopar® Spray White Lube to ensure quiet, easy operation and to protect against rust and wear. Prior to the application of any lubricant, the parts concerned should be wiped clean to remove dust and grit; after lubricating, excess oil and grease should be removed. Particular attention should also be given to hood latching components to ensure proper function. When performing other underhood services, the hood latch, release mechanism and safety catch should be cleaned and lubricated.

The external lock cylinders should be lubricated twice a year, preferably in the Autumn and Spring. Apply a small amount of a high quality lubricant, such as Mopar® Lock Cylinder Lubricant directly into the lock cylinder.

## WINDSHIELD WIPER BLADES

Clean the rubber edges of the wiper blades and the windshield periodically with a sponge or soft cloth and a mild nonabrasive cleaner. This will remove accumulations of salt or road film.

Operation of the wipers on dry glass for long periods may cause deterioration of the wiper blades. Always use washer fluid when using the wipers to remove salt or dirt from a dry windshield.

Avoid using the wiper blades to remove frost or ice from the windshield. Keep the blade rubber out of contact with petroleum products such as engine oil, gasoline, etc.

### NOTE:

Life expectancy of wiper blades varies depending on geographical area and frequency of use. Poor performance of blades may be present with chattering, marks, water lines or wet spots. If any of these conditions are present, clean the wiper blades or replace as necessary.

## Wiper Blade Removal/Installation

### CAUTION!

Do not allow the wiper arm to spring back against the glass without the wiper blade in place or the glass may be damaged.

1. Lift the wiper arm to raise the wiper blade off of the glass, until the wiper arm is in the full up position.
2. To disengage the wiper blade from the wiper arm, press the release tab on the wiper blade and while holding the wiper arm with one hand, slide the wiper blade down towards the base of the wiper arm.

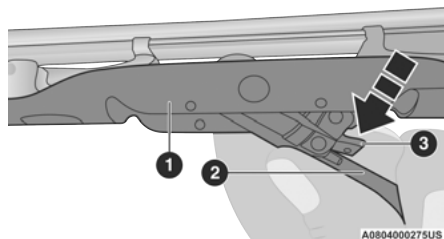

**Wiper Blade With Release Tab In Unlocked Position**

- 1 – Wiper Blade
- 2 – Wiper Arm
- 3 – Release Tab

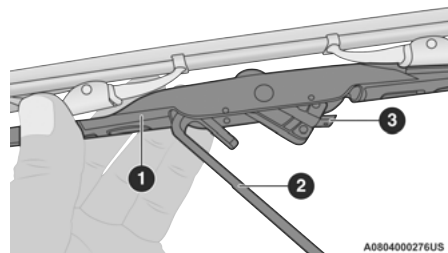

**Wiper Blade Removed From Wiper Arm**

- 1 – Wiper Blade
- 2 – Wiper Arm
- 3 – Release Tab

3. With the wiper blade disengaged, remove the wiper blade from the wiper arm.

4. Gently lower the wiper arm onto the glass.



### Installing The Front Wipers

1. Lift the wiper arm off of the glass, until the wiper arm is in the full up position.
2. Position the wiper blade near the hook on the tip of the wiper arm.
3. Insert the hook on the tip of the arm through the opening in the wiper blade.
4. Slide the wiper blade up into the hook on the wiper arm, latch engagement will be accompanied by an audible click.
5. Gently lower the wiper blade onto the glass.

### EXHAUST SYSTEM

The best protection against carbon monoxide entry into the vehicle body is a properly maintained engine exhaust system.

If you notice a change in the sound of the exhaust system; or if the exhaust fumes can be detected inside the vehicle; or when the underside or rear of the vehicle is damaged; have an authorized technician inspect the complete exhaust system and adjacent body areas for broken, damaged, deteriorated, or mispositioned parts. Open seams or loose connections could permit exhaust fumes to seep into the passenger compartment.

In addition, have the exhaust system inspected each time the vehicle is raised for lubrication or oil change. Replace as required.

#### WARNING!

- Exhaust gases can injure or kill. They contain carbon monoxide (CO), which is colorless and odorless. Breathing it can make you unconscious and can eventually poison you. To avoid breathing CO, ⇨ page 226.
- A hot exhaust system can start a fire if you park over materials that can burn. Such materials might be grass or leaves coming into contact with your exhaust system. Do not park or operate your vehicle in areas where your exhaust system can contact anything that can burn.

#### CAUTION!

- The catalytic converter requires the use of unleaded fuel only. Leaded gasoline will destroy the effectiveness of the catalyst as an emissions control device and may seriously reduce engine performance and cause serious damage to the engine.

*(Continued)*

#### CAUTION!

- Damage to the catalytic converter can result if your vehicle is not kept in proper operating condition. In the event of engine malfunction, particularly involving engine misfire or other apparent loss of performance, have your vehicle serviced promptly. Continued operation of your vehicle with a severe malfunction could cause the converter to overheat, resulting in possible damage to the converter and vehicle.

Under normal operating conditions, the catalytic converter will not require maintenance. However, it is important to keep the engine properly tuned to ensure proper catalyst operation and prevent possible catalyst damage.

#### NOTE:

Intentional tampering with emissions control systems can result in civil penalties being assessed against you.

In unusual situations involving grossly malfunctioning engine operation, a scorching odor may suggest severe and abnormal catalyst overheating. If this occurs, stop the vehicle, turn off the engine and allow it to cool. Service, including a tune-up to manufacturer's specifications, should be obtained immediately.

To minimize the possibility of catalytic converter damage:

- Do not shut off the engine or interrupt the ignition when the transmission is in gear and the vehicle is in motion.
- Do not try to start the engine by pushing or towing the vehicle.
- Do not idle the engine with any spark plug wires disconnected or removed, such as when diagnostic testing, or for prolonged periods during very rough idle or malfunctioning operating conditions.

#### NOTE:

The vehicle exhaust system may be equipped with an Electronic Exhaust Valve (EEV) system, if the exhaust system is replaced with aftermarket products a Malfunction Indicator Lamp (MIL) will illuminate.

## COOLING SYSTEM

### WARNING!

- You or others can be badly burned by hot engine coolant (antifreeze) or steam from your radiator. If you see or hear steam coming from under the hood, do not open the hood until the radiator has had time to cool. Never open a cooling system pressure cap when the radiator or coolant bottle is hot.
- Keep hands, tools, clothing, and jewelry away from the radiator cooling fan when the hood is raised. The fan starts automatically and may start at any time, whether the engine is running or not.
- When working near the radiator cooling fan, disconnect the fan motor lead or turn the ignition to the OFF mode. The fan is temperature controlled and can start at any time the ignition is in the ON mode.

### Coolant Checks

Check engine coolant (antifreeze) protection every 12 months (before the onset of freezing weather, where applicable). If the engine coolant is dirty, the system should be drained, flushed, and refilled with fresh Organic Additive Technology (OAT) coolant (conforming to MS.90032) by an

authorized dealer. Check the front of the radiator for any accumulation of bugs, leaves, etc. If dirty, clean by gently spraying water from a garden hose vertically down the face of the condenser.

Check the coolant recovery bottle tubing for brittle rubber, cracking, tears, cuts, and tightness of the connection at the bottle and radiator. Inspect the entire system for leaks. **DO NOT REMOVE THE COOLANT PRESSURE CAP WHEN THE COOLING SYSTEM IS HOT.**

### Cooling System — Drain, Flush And Refill

#### NOTE:

Some vehicles require special tools to add coolant properly. Failure to fill these systems properly could lead to severe internal engine damage. If any coolant is needed to be added to the system please contact an authorized dealer.

If the engine coolant (antifreeze) is dirty or contains visible sediment, have an authorized dealer clean and flush with Organic Additive Technology (OAT) coolant (conforming to MS.90032).

For the proper maintenance intervals → page 252.

## Selection Of Coolant

For further information → page 312.

### NOTE:

- Mixing of engine coolant (antifreeze) other than specified Organic Additive Technology (OAT) engine coolant, may result in engine damage and may decrease corrosion protection. OAT engine coolant is different and should not be mixed with Hybrid Organic Additive Technology (HOAT) engine coolant or any "globally compatible" coolant. If a non-OAT engine coolant is introduced into the cooling system in an emergency, the cooling system will need to be drained, flushed, and refilled with fresh OAT coolant (conforming to MS.90032), by an authorized dealer as soon as possible.
- Do not use water alone or alcohol-based engine coolant products. Do not use additional rust inhibitors or antirust products, as they may not be compatible with the radiator engine coolant and may plug the radiator.
- This vehicle has not been designed for use with propylene glycol-based engine coolant. Use of propylene glycol-based engine coolant is not recommended.

- Some vehicles require special tools to add coolant properly. Failure to fill these systems properly could lead to severe internal engine damage. If any coolant is needed to be added to the system please contact an authorized dealer.

### Adding Coolant

Your vehicle has been built with an improved engine coolant (OAT coolant conforming to MS.90032) that allows extended maintenance intervals. This engine coolant (antifreeze) can be used up to 10 years or 150,000 miles (240,000 km) before replacement. To prevent reducing this extended maintenance period, it is important that you use the same engine coolant (OAT coolant conforming to MS.90032) throughout the life of your vehicle.

Please review these recommendations for using Organic Additive Technology (OAT) engine coolant that meets the requirements of the manufacturer Material Standard MS.90032. When adding engine coolant:

- We recommend using Mopar® Antifreeze/Coolant 10 Year/150,000 Mile (240,000 km) Formula OAT that meets the requirements of the manufacturer Material Standard MS.90032.

- Mix a minimum solution of 50% OAT engine coolant that meets the requirements of the manufacturer Material Standard MS.90032 and distilled water. Use higher concentrations (not to exceed 70%) if temperatures below  $-34^{\circ}\text{F}$  ( $-37^{\circ}\text{C}$ ) are anticipated. Please contact an authorized dealer for assistance.
- Use only high purity water such as distilled or deionized water when mixing the water/engine coolant solution. The use of lower quality water will reduce the amount of corrosion protection in the engine cooling system.

### NOTE:

- It is the owner's responsibility to maintain the proper level of protection against freezing according to the temperatures occurring in the area where the vehicle is operated.
- Some vehicles require special tools to add coolant properly. Failure to fill these systems properly could lead to severe internal engine damage. If any coolant is needed to be added to the system, please contact an authorized dealer.
- Mixing engine coolant types is not recommended and can result in cooling system damage. If HOAT and OAT coolant are mixed in an emergency, have an authorized dealer drain, flush, and refill with OAT coolant (conforming to MS.90032) as soon as possible.

## Cooling System Pressure Cap

The cap must be fully tightened to prevent loss of engine coolant (antifreeze), and to ensure that engine coolant will return to the radiator from the coolant expansion bottle/recovery tank (if equipped).

The cap should be inspected and cleaned if there is any accumulation of foreign material on the sealing surfaces.

### WARNING!

- Do not open hot engine cooling system. Never add engine coolant (antifreeze) when the engine is overheated. Do not loosen or remove the cap to cool an overheated engine. Heat causes pressure to build up in the cooling system. To prevent scalding or injury, do not remove the pressure cap while the system is hot or under pressure.
- Do not use a pressure cap other than the one specified for your vehicle. Personal injury or engine damage may result.

## Disposal Of Used Coolant

Used ethylene glycol-based coolant (antifreeze) is a regulated substance requiring proper disposal. Check with your local authorities to determine the disposal rules for your community. To prevent ingestion by animals or children, do not store ethylene glycol-based coolant in open containers or allow it to remain in puddles on the ground: clean up any ground spills immediately. If ingested, seek emergency assistance immediately.

## Coolant Level

The coolant bottle provides a quick visual method for determining that the engine coolant (antifreeze) level is adequate. With the engine off and cold, the level of the engine coolant in the bottle should be between the ranges indicated on the bottle.

The radiator normally remains completely full, so there is no need to remove the radiator cap unless checking for engine coolant freeze point or replacing engine coolant. Advise your service attendant of this. As long as the engine operating temperature is satisfactory, the coolant bottle need only be checked once a month.

When additional engine coolant is needed to maintain the proper level, it should be added to the coolant bottle. Do not overfill.

## Cooling System Notes

### NOTE:

When the vehicle is stopped after a few miles/kilometers of operation, you may observe vapor coming from the front of the engine compartment. This is normally a result of moisture from rain, snow, or high humidity accumulating on the radiator and being vaporized when the thermostat opens, allowing hot engine coolant (antifreeze) to enter the radiator.

If an examination of your engine compartment shows no evidence of radiator or hose leaks, the vehicle may be safely driven. The vapor will soon dissipate.

- Do not overfill the coolant expansion bottle.
- Check the coolant freeze point in the radiator and in the coolant expansion bottle. If engine coolant needs to be added, the contents of the coolant expansion bottle must also be protected against freezing.
- If frequent engine coolant additions are required, the cooling system should be pressure tested for leaks.
- Maintain engine coolant concentration at a minimum of 50% OAT coolant (conforming to MS.90032) and distilled water for proper corrosion protection of your engine which contains aluminum components.

- Make sure that the coolant expansion bottle overflow hoses are not kinked or obstructed.
- Keep the front of the radiator clean. If your vehicle is equipped with air conditioning, keep the front of the condenser clean.
- Do not change the thermostat for Summer or Winter operation. If replacement is ever necessary, install **ONLY** the correct type thermostat. Other designs may result in unsatisfactory engine cooling performance, poor gas mileage, and increased emissions.

## BRAKE SYSTEM

In order to ensure brake system performance, all brake system components should be inspected periodically ↪ page 252.

### WARNING!

Riding the brakes can lead to brake failure and possibly a collision. Driving with your foot resting or riding on the brake pedal can result in abnormally high brake temperatures, excessive lining wear, and possible brake damage. You would not have your full braking capacity in an emergency.

## Fluid Level Check — Brake Master Cylinder

Check the fluid level in the master cylinder immediately if the Brake System Warning Light indicates system failure.

Check the fluid level in the master cylinder when performing underhood services.

Clean the top of the master cylinder area before removing the cap. Add fluid to bring the level up to the top of the "FULL" mark on the side of the master cylinder reservoir.

Overfilling of fluid is not recommended because it may cause leaking in the system.

Add enough fluid to bring the level up to the requirements described on the brake fluid reservoir. With disc brakes, fluid level can be expected to fall as the brake pads wear. However, low fluid level may be caused by a leak and a checkup may be needed.

Use only brake fluid that has been recommended by the manufacturer, and has been kept in a tightly closed container to avoid contamination from foreign matter or moisture ↪ page 312.

### WARNING!

- Use only manufacturer's recommended brake fluid ↪ page 312. Using the wrong type of brake fluid can severely damage your brake system and/or impair its performance. The proper type of brake fluid for your vehicle is also identified on the original factory installed hydraulic master cylinder reservoir.
- To avoid contamination from foreign matter or moisture, use only new brake fluid or fluid that has been in a tightly closed container. Keep the master cylinder reservoir cap secured at all times. Brake fluid in an open container absorbs moisture from the air resulting in a lower boiling point. This may cause it to boil unexpectedly during hard or prolonged braking, resulting in sudden brake failure. This could result in a collision.

*(Continued)*

**WARNING!**

- Overfilling the brake fluid reservoir can result in spilling brake fluid on hot engine parts, causing the brake fluid to catch fire. Brake fluid can also damage painted and vinyl surfaces, care should be taken to avoid its contact with these surfaces.
- Do not allow petroleum based fluid to contaminate the brake fluid. Brake seal components could be damaged, causing partial or complete brake failure. This could result in a collision.

**CLUTCH HYDRAULIC SYSTEM — MANUAL TRANSMISSION (IF EQUIPPED)**

The clutch hydraulic system is fed by a segregated volume of fluid within the brake system master cylinder reservoir. In the event of leakage or wear, use only the manufacturer's recommended brake fluid ↪ page 312.

**MANUAL TRANSMISSION — IF EQUIPPED****Fluid Level Check**

Check the fluid level by removing the fill plug on the left side of the transmission. The fluid level should be 1/4 inch (6.4mm) below the bottom of the fill hole. Add fluid, if necessary, to maintain the proper level ↪ page 312.

**CAUTION!**

Using a transmission fluid other than the manufacturer's recommended fluid may cause deterioration in transmission shift quality and/or damage to the transmission ↪ page 312.

**Change Transmission Fluid**

If contaminated with water, change the fluid immediately. See an authorized dealer for service. For the proper maintenance intervals ↪ page 252.

**AUTOMATIC TRANSMISSION — IF EQUIPPED****Special Additives**

The manufacturer strongly recommends against using any special additives in the transmission. Automatic Transmission Fluid (ATF) is an engineered product and its performance may be impaired by supplemental additives. Therefore, do not add any fluid additives to the transmission. Avoid using transmission sealers as they may adversely affect seals.

**CAUTION!**

Do not use chemical flushes in your transmission as the chemicals can damage your transmission components. Such damage is not covered by the New Vehicle Limited Warranty.

## Fluid Level Check

The fluid level is preset at the factory and does not require adjustment under normal operating conditions. Routine fluid level checks are not required; therefore the transmission has no dipstick. An authorized dealer can check your transmission fluid level using special service tools. If you notice fluid leakage or transmission malfunction, visit an authorized dealer immediately to have the transmission fluid level checked. Operating the vehicle with an improper fluid level can cause severe transmission damage.

### CAUTION!

If a transmission fluid leak occurs, visit an authorized dealer immediately. Severe transmission damage may occur. An authorized dealer has the proper tools to adjust the fluid level accurately.

## Fluid And Filter Changes

Under normal operating conditions, the fluid installed at the factory will provide satisfactory lubrication for the life of the vehicle.

Routine fluid and filter changes are not required. However, change the fluid and filter if the fluid becomes contaminated (with water, etc.), or if the transmission is disassembled for any reason.

## Selection Of Lubricant

It is important to use the proper transmission fluid to ensure optimum transmission performance and life. Use only the manufacturer's specified transmission fluid ↗ page 312. It is important to maintain the transmission fluid at the correct level using the recommended fluid.

### NOTE:

No chemical flushes should be used in any transmission; only the approved lubricant should be used.

### CAUTION!

Using a transmission fluid other than the manufacturer's recommended fluid may cause deterioration in transmission shift quality and/or torque converter shudder ↗ page 312.

## ALL WHEEL DRIVE (AWD) — IF EQUIPPED

The All Wheel Drive system consists of a transfer case and front differential. The exterior surface of these components should be inspected for evidence of fluid leaks. Confirmed leaks should be repaired as soon as possible.

The transfer case fluid fill/inspection plug is located in the middle of the rear housing. To inspect the transfer case fluid level, remove the fill/inspection plug. The fluid level should be even with the bottom of the hole. Use this plug to add fluid as required.

The front differential fill plug is located on the outer cover near the half shaft attachment. To inspect the differential fluid level, remove the fill plug. The fluid level should be even with or slightly below the bottom of the hole.

## Fluid Changes

For the proper maintenance intervals ↗ page 251.

## REAR AXLE

### Fluid Level Check

Checking the fluid level while the vehicle is on level ground and has been stationary for 15 minutes will improve the accuracy of the fluid level reading.

Check the fluid level by removing the fill plug on the axle. The fluid level should be 1-2.5 mm below the fill plug. Add fluid, if necessary, to maintain the proper level ↗ page 312.

### Change Axle Fluid

For the proper maintenance intervals ↗ page 251.

## FUSES

### General Information

#### WARNING!

- When replacing a blown fuse, always use an appropriate replacement fuse with the same amp rating as the original fuse. Never replace a fuse with another fuse of higher amp rating. Never replace a blown fuse with metal wires or any other material. Do not place a fuse inside a circuit breaker cavity or vice versa. Failure to use proper fuses may result in serious personal injury, fire and/or property damage.
- Before replacing a fuse, make sure that the ignition is off and that all the other services are switched off and/or disengaged.

(Continued)

#### WARNING!

- If the replaced fuse blows again, contact an authorized dealer.
- If a general protection fuse for safety systems (air bag system, braking system), power unit systems (engine system, transmission system) or steering system blows, contact an authorized dealer.

The fuses protect electrical systems against excessive current.

When a device does not work, you must check the fuse element inside the blade fuse for a break/melt.

Also, please be aware that using power outlets for extended periods of time with the engine off may result in vehicle battery discharge.

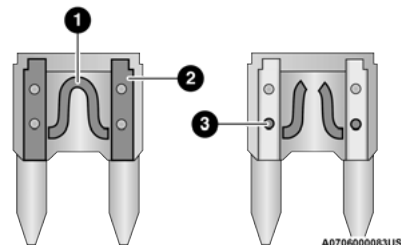

**Blade Fuses**

- 1 — Fuse Element
- 2 — Blade Fuse with a good/functional fuse element
- 3 — Blade fuse with a bad/not functional fuse element (blown fuse)



## Underhood Fuses

The Front Power Distribution Center is located in the engine compartment. This module contains fuses and relays. Fuse cavity location and descriptions are printed on the inside of the power distribution center cover.

### CAUTION!

- When installing the power distribution center cover, it is important to ensure the cover is properly positioned and fully latched. Failure to do so may allow water to get into the power distribution center and possibly result in an electrical system failure.
- When replacing a blown fuse, it is important to use only a fuse having the correct amperage rating. The use of a fuse with a rating other than indicated may result in a dangerous electrical system overload. If a properly rated fuse continues to blow, it indicates a problem in the circuit that must be corrected.

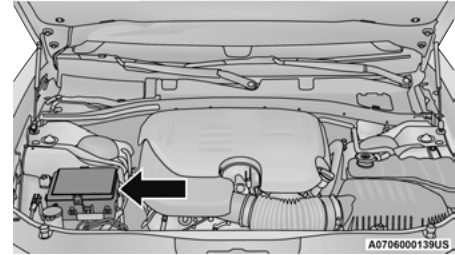

**Front Power Distribution Center Location**

Cavity	Cartridge Fuse	Mini-Fuse	Description
* If Equipped			
F01	-	-	Spare
F02	40 Amp Green	-	Radiator Fan #1 - (Non 6.2L Supercharged)
F03	50 Amp Red	-	Electric Power Steering #1*
F04	30 Amp Pink	-	Starter
F05	40 Amp Green	-	Anti Lock Brake
F06	30 Amp Pink	-	Anti Lock Brake
F07	20 Amp Blue	-	Police Ignition Run / ACC #1
F08	20 Amp Blue	-	Police Ignition Run / ACC # 2

Cavity	Cartridge Fuse	Mini-Fuse	Description
<b>* If Equipped</b>			
F09	-	20 Amp Yellow	All-Wheel Drive Module*
F10	-	10 Amp Red	Intrusion MOD (300)* / Under Hood Lamp - Police
F11	-	20 Amp Yellow	Horns
F12	-	10 Amp Red	Air Conditioning Clutch
F13	-	-	Spare
F14	-	-	Spare
F15	-	20 Amp Yellow	Left HID Headlamp*
F16	-	20 Amp Yellow	Right HID Headlamp*
F18	50 Amp Red	-	Radiator Fan - (Non 6.2L Supercharged)
F19	50 Amp Red	-	Electric Power Steering #2*
F20	30 Amp Pink	-	Wiper Motor
F21	30 Amp Pink	-	Headlamp Washers*
	20 Amp Blue - Police		Police Bat Feed #2
F22	20 Amp Blue - Police	-	Police Bat Feed # 3
F23	20 Amp Blue	-	Police Bat Feed # 1
F24	20 Amp Blue	-	Police Ignition Run/ACC Feed # 3
F28	-	-	Spare

Cavity	Cartridge Fuse	Mini-Fuse	Description
<b>* If Equipped</b>			
F29	-	15 Amp Blue	Auto Trans (Challenger / Charger Police)
F30	-	-	Spare
F31	-	25 Amp Clear	Engine Module
F32	-	-	Spare
F33	-	-	Spare
F34	-	25 Amp Clear	ASD Feed #1
F35	-	20 Amp Yellow	ASD Feed #2
F36	-	10 Amp Red	Anti-Lock Brake Module / Steering Column Lock Module*
F37	-	10 Amp Red	Engine Controller
F38	-	10 Amp Red	Airbag Module
F39	-	10 Amp Red	AC Clutch/ EPS*/ Vacuum Pump*
F48	-	10 Amp Red	AWD Module / Front Axle Disconnect*
F49	-	-	Spare
F50	-	-	Spare
F51	-	20 Amp Yellow	Vacuum Pump*
F52	-	5 Amp Tan	Adaptive Cruise Control*
F53	-	-	Spare

## Rear Interior Fuses

There is also a power distribution center located in the trunk under the spare tire access panel. This center contains fuses and relays. Fuse cavity location and descriptions are printed on the inside of the power distribution center cover.

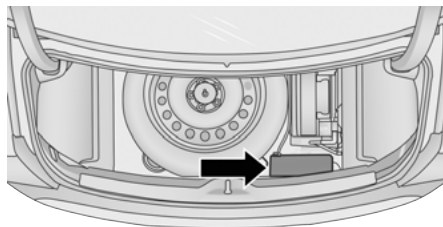

A0706000201US

**Rear Power Distribution Center**

### CAUTION!

- When installing the power distribution center cover, it is important to ensure the cover is properly positioned and fully latched. Failure to do so may allow water to get into the power distribution center and possibly result in an electrical system failure.
- When replacing a blown fuse, it is important to use only a fuse having the correct amperage rating. The use of a fuse with a rating other than indicated may result in a dangerous electrical system overload. If a properly rated fuse continues to blow, it indicates a problem in the circuit that must be corrected.

Cavity	Cartridge Fuse	Mini-Fuse	Description
<b>* If Equipped</b>			
F02	60 Amp Yellow	-	Front PDC Feed #1
F03	-	-	Spare
F04	60 Amp Yellow	-	Front PDC Feed #2
F05	30 Amp Pink	-	Sunroof
	20 Amp Blue – Police		Dome Lamp – Police
F06	40 Amp Green	-	Exterior Lighting #1
F07	40 Amp Green	-	Exterior Lighting #2
F08	30 Amp Pink	-	Interior Lighting

Cavity	Cartridge Fuse	Mini-Fuse	Description
<b>* If Equipped</b>			
F09	40 Amp Green	-	Power Locks
F10	30 Amp Pink	-	Driver Door Control Module
F11	30 Amp Pink	-	Passenger Door Control Module
F12	-	20 Amp Yellow	Cigar Lighter/IP APO/RR USB (Selectable Fuse) *
F15	40 Amp Green	-	HVAC Blower
F16	20 Amp Blue	-	Left Spot Lamp - Police
F17	20 Amp Blue	-	Right Spot Lamp - Police
F18	30 Amp Pink	-	VISM MOD (Police)
F19	-	-	Spare
F20	-	-	Spare
F21	30 Amp Pink	-	Fuel Pump (Non 6.2L ADR)
F22	-	5 Amp Tan	Cyber Gateway Mod
F23	-	10 Amp Red	Fuel Door */Diagnostic Port
F24	-	10 Amp Red	Integrated Center Stack
F25	-	10 Amp Red	Tire Pressure Monitor
F26	-	15 Amp Blue	Trans Mod (Charger Non- Police/300)
F27	-	25 Amp Clear	Amplifier *
F31	-	25 Amp Breaker	Power Seats *
F32	-	15 Amp Blue	HVAC Module/Cluster

Cavity	Cartridge Fuse	Mini-Fuse	Description
<b>* If Equipped</b>			
F33	-	15 Amp Blue	IGN SW/Wireless Mod/Steer Clmn Lock Mod/Remote Start – *
F34	-	10 Amp Red	Steering Column Module/Clock (300)
F35	-	5 Amp Tan	Battery Sensor
F36	-	15 Amp Blue	Active Exhaust Valve *
F37	-	20 Amp Yellow	Radio
F38	-	20 Amp Yellow	Media Hub/ Console APO
F42	30 Amp Pink	-	Rear Defrost
F43	-	20 Amp Yellow	RR Heated Seat / Heated Steering Wheel *
F44	-	10 Amp Red	Park Assist / Blind Spot / Rear View Camera *
F45	-	15 Amp Blue	Cluster / Rearview Mirror / Lane Departure
F46	-	-	Spare
F47	-	10 Amp Red	Adaptive Front Lighting / Day Time Running Lamps *
F49	-	-	Spare
F50	-	-	Spare
F51	-	20 Amp Yellow	Front Heated / Vented Seats *
F52	-	10 Amp Red	Heated Cupholders/Rear Heated Seat Switches *
F53	-	10 Amp Red	HVAC Module/In Vehicle Temperature Sensor
F54	-	-	Spare
F55	-	-	Spare

Cavity	Cartridge Fuse	Mini-Fuse	Description
<b>* If Equipped</b>			
F56	-	-	Spare
F57	-	-	Spare
F58	-	10 Amp Red	Airbag Module
F59	-	20 Amp Yellow	Adjustable Pedals - Police
F60	-	-	Spare
F61	-	-	Spare
F62	-	-	Spare
F63	-	-	Spare
F64	-	25 Amp Breaker	Rear Windows (Charger/300)
F65	-	10 Amp Red	Airbag Module
F66	-	-	Spare
F67	-	10 Amp Red	Rain and Light Sensor / Sunroof / Inside RR View Mirror / Police Run Acc Relay
F68	-	10 Amp Red	RR USB Timer/ RR Sunshade *
F69	-	-	Spare
F70	-	-	Spare

## BULB REPLACEMENT

### Replacement Bulbs

**NOTE:**

See an authorized dealer for LED bulb replacement.

All of the interior bulbs are glass wedge base or glass cartridge types. Aluminum base bulbs are not approved and should not be used for replacement.

Interior Bulbs	
Bulb Name	Bulb Number
Rear Courtesy/Reading Lamps	W5W
Rear Compartment (Trunk) Lamp	562
Overhead Console Reading Lamps	578
Visor Vanity Lamps	A6220
Glove Compartment Lamp - If Equipped	194
Door Courtesy	562
Shift Indicator Lamp	JKLE14140
Optional Door Map Pocket/Cupholder	LED
For lighted switches, see an authorized dealer for replacement instructions.	



Exterior Bulbs	
Bulb Name	Bulb Number
Headlamp - High Intensity Discharge (HID)	D3S*
Halogen Headlamp	HIR2LL
Front Park/Turn Lamp	LED
Front Fog Lamp	H11LL
Front Side Marker	LED
Tail Lamp	LED
Stop/Turn Lamp	LED
Rear Side Marker	LED
Backup Lamp	LED
Center High Mount Stop Lamp (CHMSL)	LED
License	LED

\* The headlamps are a type of high-voltage discharge tube. High voltage can remain in the circuit even with the headlamp switch off and the key removed. Because of this, you should not attempt to service a headlamp bulb yourself. If a headlamp bulb fails, take your vehicle to an authorized dealer for service.

## Replacing Exterior Bulbs

### LOW BEAM HEADLAMP, HIGH BEAM HEADLAMP – MODELS WITH HALOGEN HEADLAMPS – IF EQUIPPED

See the following steps to replace:

1. Open the hood.

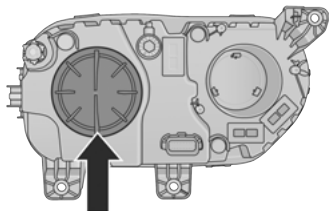

A0705000459US

**Headlamp Assembly Dust Cap Location**

#### NOTE:

Removal of the air cleaner filter housing may be necessary prior to replacing bulbs in the headlamp assembly on the driver side of the vehicle.

2. Remove the large dust cap from the headlamp housing by turning it counterclockwise.
3. Turn the bulb counterclockwise, and remove.

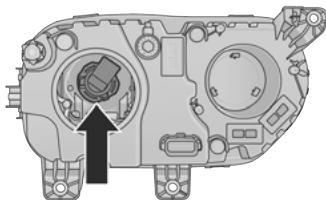

A0705000458US

**Headlamp Location**

4. Disconnect the bulb from the socket assembly and install the replacement bulb.
5. Reinstall the bulb and socket assembly into the headlamp assembly, and then turn it clockwise.

6. Reinstall the access cap making sure it is seated into the housing and turn cap clockwise to engage locking lugs. Visually, you should be unable to see the blue O-ring gasket. The access cap should be uniformly seated and you should not be able to pull the access cap off without turning it counterclockwise.

#### CAUTION!

If the access cap is not installed correctly after bulb replacement, the lamp becomes susceptible to dust, condensation, and water intrusion. This may ultimately lead to an inoperative lamp. If the access cap cannot be installed correctly, please return to an authorized dealer for proper repair or access cap replacement if necessary.

#### CAUTION!

Do not touch the new bulb with your fingers. Oil contamination will severely shorten bulb life. If the bulb comes in contact with any oily surface, clean the bulb with rubbing alcohol.

### LOW BEAM HEADLAMP, HIGH BEAM HEADLAMP — MODELS WITH HIGH INTENSITY DISCHARGE (HID) HEADLAMPS — IF EQUIPPED

The headlamps are a type of high voltage discharge tube. High voltage can remain in the circuit even with the headlamp switch off and the key removed. **Because of this, you should not attempt to service a headlamp bulb yourself. If a headlamp bulb fails, take your vehicle to an authorized dealer for service.**

#### WARNING!

A transient high voltage occurs at the bulb sockets of HID headlamps when the headlamp switch is turned ON. It may cause serious electrical shock or electrocution if not serviced properly. See an authorized dealer for service.

#### NOTE:

On vehicles equipped with HID headlamps, when the headlamps are turned on, there is a blue hue to the lamps. This diminishes and becomes more white after approximately 10 seconds, as the system charges.

### FRONT PARK/SIGNATURE LAMP

The Front Park/Signature function is part of the headlamp assembly and use LED lamps that are not serviceable separately. The headlamps must be replaced as an assembly, see an authorized dealer.

### FRONT TURN/DRL LAMP

The Front Turn/DRL function is part of the headlamp assembly and use LED lamps that are not serviceable separately. The headlamps must be replaced as an assembly, see an authorized dealer.

### FRONT/REAR SIDE MARKER LAMP

The Side Markers use LED lamps that are not serviceable separately. The Side Markers must be replaced as an assembly, see an authorized dealer.

### TAIL/TURN AND STOP LAMP

The Tail/Turn and Stop Lamps use LED lamps that are not serviceable separately. The Tail/Turn and Stop Lamps must be replaced as an assembly, see an authorized dealer.

### CENTER TAIL/BACKUP LAMP

The Center Tail/Backup Lamp use LED lamps that are not serviceable separately. The Center Tail/Backup Lamp must be replaced as an assembly; see an authorized dealer.

### CENTER HIGH MOUNTED STOP LAMP (CHMSL)

The CHMSL Lamp uses LED sources that are not serviceable separately. The CHMSL Lamp must be replaced as an assembly; see an authorized dealer.

### LICENSE LAMP

The License Lamp uses an LED source that is not serviceable separately. The License Lamp must be replaced as an assembly; see an authorized dealer.

## TIRES

### TIRE SAFETY INFORMATION

Tire safety information will cover aspects of the following information: Tire Markings, Tire Identification Numbers, Tire Terminology and Definitions, Tire Pressures, and Tire Loading.

## Tire Markings

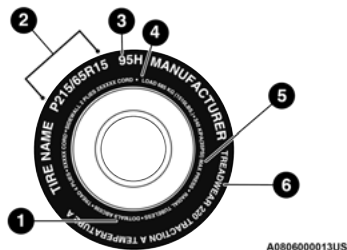

### Tire Markings

- 1 – US DOT Safety Standards Code (TIN)
- 2 – Size Designation
- 3 – Service Description
- 4 – Maximum Load
- 5 – Maximum Pressure
- 6 – Treadwear, Traction and Temperature Grades

### NOTE:

- P (Passenger) – Metric tire sizing is based on US design standards. P-Metric tires have the letter “P” molded into the sidewall preceding the size designation.  
Example: P215/65R15 95H.
- European – Metric tire sizing is based on European design standards. Tires designed to this standard have the tire size molded into the sidewall beginning with the section width. The letter “P” is absent from this tire size designation.  
Example: 215/65R15 96H.
- LT (Light Truck) – Metric tire sizing is based on US design standards. The size designation for LT-Metric tires is the same as for P-Metric tires except for the letters “LT” that are molded into the sidewall preceding the size designation.  
Example: LT235/85R16.
- Temporary spare tires are designed for temporary emergency use only. Temporary high pressure compact spare tires have the letter “T” or “S” molded into the sidewall preceding the size designation.  
Example: T145/80D18 103M.
- High flotation tire sizing is based on US design standards and it begins with the tire diameter molded into the sidewall.  
Example: 31x10.5 R15 LT.

## TIRE SIZING CHART

<b>EXAMPLE:</b>
<b>Example Size Designation: P215/65R15XL 95H, 215/65R15 96H, LT235/85R16C, T145/80D18 103M, 31x10.5 R15 LT</b>
<p><b>P</b> = Passenger car tire size based on US design standards, or  <b>"...blank..."</b> = Passenger car tire based on European design standards, or  <b>LT</b> = Light truck tire based on US design standards, or  <b>T or S</b> = Temporary spare tire or  <b>31</b> = Overall diameter in inches (in)  <b>215, 235, 145</b> = Section width in millimeters (mm)  <b>65, 85, 80</b> = Aspect ratio in percent (%) <ul style="list-style-type: none"> <li>● Ratio of section height to section width of tire, or</li> </ul> <b>10.5</b> = Section width in inches (in)</p>
<p><b>R</b> = Construction code <ul style="list-style-type: none"> <li>● "R" means radial construction, or</li> <li>● "D" means diagonal or bias construction</li> </ul> <b>15, 16, 18</b> = Rim diameter in inches (in)</p>
<b>Service Description:</b>
<p><b>95</b> = Load Index <ul style="list-style-type: none"> <li>● A numerical code associated with the maximum load a tire can carry</li> </ul> </p>
<p><b>H</b> = Speed Symbol <ul style="list-style-type: none"> <li>● A symbol indicating the range of speeds at which a tire can carry a load corresponding to its load index under certain operating conditions</li> <li>● The maximum speed corresponding to the speed symbol should only be achieved under specified operating conditions (i.e., tire pressure, vehicle loading, road conditions, and posted speed limits)</li> </ul> </p>

**EXAMPLE:****Load Identification:**

Absence of the following load identification symbols on the sidewall of the tire indicates a Standard Load (SL) tire:

- **XL** = Extra load (or reinforced) tire, or
- **LL** = Light load tire or
- **C, D, E, F, G** = Load range associated with the maximum load a tire can carry at a specified pressure

**Maximum Load** – Maximum load indicates the maximum load this tire is designed to carry

**Maximum Pressure** – Maximum pressure indicates the maximum permissible cold tire inflation pressure for this tire

**Tire Identification Number (TIN)**

The TIN may be found on one or both sides of the tire; however, the date code may only be on one side. Tires with white sidewalls will have the full TIN, including the date code, located on the white sidewall side of the tire. Look for the TIN on the outboard side of black sidewall tires as mounted on the vehicle. If the TIN is not found on the outboard side, then you will find it on the inboard side of the tire.

**EXAMPLE:**

DOT MA L9 ABCD 0301

**DOT** = Department of Transportation

- This symbol certifies that the tire is in compliance with the US Department of Transportation tire safety standards and is approved for highway use

**MA** = Code representing the tire manufacturing location (two digits)

**L9** = Code representing the tire size (two digits)

**ABCD** = Code used by the tire manufacturer (one to four digits)

**03** = Number representing the week in which the tire was manufactured (two digits)

- 03 means the 3rd week

**EXAMPLE:**

**01** = Number representing the year in which the tire was manufactured (two digits)

- 01 means the year 2001
- Prior to July 2000, tire manufacturers were only required to have one number to represent the year in which the tire was manufactured. Example: 031 could represent the 3rd week of 1981 or 1991

**Tire Terminology And Definitions**

<b>Term</b>	<b>Definition</b>
<b>B-pillar</b>	The vehicle B-pillar is the structural member of the body located behind the front door.
<b>Cold Tire Inflation Pressure</b>	Cold tire inflation pressure is defined as the tire pressure after the vehicle has not been driven for at least three hours, or driven less than 1 mile (1.6 km) after sitting for a minimum of three hours. Inflation pressure is measured in units of PSI (pounds per square inch) or kPa (kilopascals).
<b>Maximum Inflation Pressure</b>	The maximum inflation pressure is the maximum permissible cold tire inflation pressure for this tire. The maximum inflation pressure is molded into the sidewall.
<b>Recommended Cold Tire Inflation Pressure</b>	Vehicle manufacturer's recommended cold tire inflation pressure as shown on the tire placard.
<b>Tire Placard</b>	A label permanently attached to the vehicle describing the vehicle's loading capacity, the original equipment tire sizes and the recommended cold tire inflation pressures.

## Tire Loading And Tire Pressure

### NOTE:

The proper cold tire inflation pressure is listed on the driver's side B-pillar or the rear edge of the driver's side door.

Check the inflation pressure of each tire, including the spare tire (if equipped), at least monthly and inflate to the recommended pressure for your vehicle.

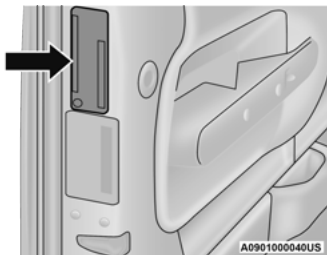

Example Tire Placard Location (Door)

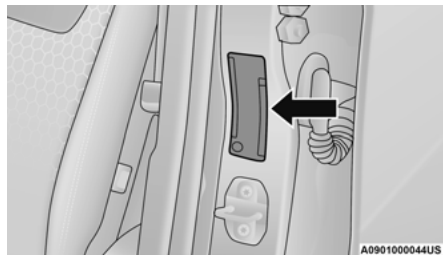

Example Tire Placard Location (B-pillar)

### Tire And Loading Information Placard



Tire And Loading Information Placard

This placard tells you important information about the:

1. Number of people that can be carried in the vehicle.
2. Total weight your vehicle can carry.
3. Tire size designed for your vehicle.
4. Cold tire inflation pressures for the front, rear, and spare tires.

### Loading

The vehicle maximum load on the tire must not exceed the load carrying capacity of the tire on your vehicle. You will not exceed the tire's load carrying capacity if you adhere to the loading conditions, tire size, and cold tire inflation pressures specified on the Tire and Loading Information placard ↪ page 109.

### NOTE:

Under a maximum loaded vehicle condition, Gross Axle Weight Rating (GAWR) for the front and rear axles must not be exceeded.

For further information on GAWR, vehicle loading, and trailer towing ↪ page 109.



To determine the maximum loading conditions of your vehicle, locate the statement “The combined weight of occupants and cargo should never exceed XXX kg or XXX lbs” on the Tire and Loading Information placard. The combined weight of occupants, cargo/luggage and trailer tongue weight (if applicable) should never exceed the weight referenced here.

#### Steps For Determining Correct Load Limit—

- (1) Locate the statement “The combined weight of occupants and cargo should never exceed XXX kg or XXX lbs.” on your vehicle's placard.
- (2) Determine the combined weight of the driver and passengers that will be riding in your vehicle.
- (3) Subtract the combined weight of the driver and passengers from XXX kg or XXX lbs.
- (4) The resulting figure equals the available amount of cargo and luggage load capacity. For example, if “XXX” amount equals 1400 lbs. and there will be five 150 lb passengers in your vehicle, the amount of available cargo and luggage load capacity is 650 lbs.  $(1400-750 (5 \times 150) = 650 \text{ lbs.})$
- (5) Determine the combined weight of luggage and cargo being loaded on the vehicle. That weight may not safely exceed the available cargo and luggage load capacity calculated in Step 4.
- (6) If your vehicle will be towing a trailer, load from your trailer will be transferred to your vehicle. Consult this manual to determine how this reduces the available cargo and luggage load capacity of your vehicle.

#### Metric Example For Load Limit

For example, if “XXX” amount equals 635 kg and there will be five 68 kg passengers in your vehicle, the amount of available cargo and luggage load capacity is 295 kg  $(635-340 (5 \times 68) = 295 \text{ kg})$  as shown in step 4.

#### NOTE:

- If your vehicle will be towing a trailer, load from your trailer will be transferred to your vehicle. The following table shows examples on how to calculate total load, cargo/luggage, and towing capacities of your vehicle with varying seating configurations and number and size of occupants. This table is for illustration purposes only and may not be accurate for the seating and load carry capacity of your vehicle.
- For the following example, the combined weight of occupants and cargo should never exceed 865 lbs (392 kg).

Occupants			Combined weight of occupants and cargo from Tire Placard	MINUS	Combined Occupant's weight	=	AVAILABLE Cargo/Luggage and Trailer Tongue Weight
TOTAL	FRONT	REAR					
<b>EXAMPLE 1</b>			865 lbs	minus	670 lbs	=	195 lbs
5	2	3					
<b>EXAMPLE 2</b>			865 lbs	minus	540 lbs	=	325 lbs
3	2	1					
<b>EXAMPLE 3</b>			865 lbs	minus	400 lbs	=	465 lbs
2	2	0					

**WARNING!**

Overloading of your tires is dangerous. Overloading can cause tire failure, affect vehicle handling, and increase your stopping distance. Use tires of the recommended load capacity for your vehicle. Never overload them.

**TIRES — GENERAL INFORMATION****Tire Pressure**

Proper tire inflation pressure is essential to the safe and satisfactory operation of your vehicle. Four primary areas are affected by improper tire pressure:

- Safety
- Fuel Economy
- Tread Wear
- Ride Comfort and Vehicle Stability

**Safety****WARNING!**

- Improperly inflated tires are dangerous and can cause collisions.
- Underinflation increases tire flexing and can result in overheating and tire failure.
- Overinflation reduces a tire's ability to cushion shock. Objects on the road and chuckholes can cause damage that result in tire failure.
- Overinflated or underinflated tires can affect vehicle handling and can fail suddenly, resulting in loss of vehicle control.
- Unequal tire pressures can cause steering problems. You could lose control of your vehicle.
- Unequal tire pressures from one side of the vehicle to the other can cause the vehicle to drift to the right or left.
- Always drive with each tire inflated to the recommended cold tire inflation pressure.

Both underinflation and overinflation affect the stability of the vehicle and can produce a feeling of sluggish response or over responsiveness in the steering.

**NOTE:**

- Unequal tire pressures from side to side may cause erratic and unpredictable steering response.
- Unequal tire pressure from side to side may cause the vehicle to drift left or right.

**Fuel Economy**

Underinflated tires will increase tire rolling resistance resulting in higher fuel consumption.

**Tread Wear**

Improper cold tire inflation pressures can cause abnormal wear patterns and reduced tread life, resulting in the need for earlier tire replacement.

**Ride Comfort And Vehicle Stability**

Proper tire inflation contributes to a comfortable ride. Overinflation produces a jarring and uncomfortable ride.

## Tire Inflation Pressures

The proper cold tire inflation pressure is listed on the driver's side B-pillar or rear edge of the driver's side door.

At least once a month:

- Check and adjust tire pressure with a good quality pocket-type pressure gauge. Do not make a visual judgment when determining proper inflation. Tires may look properly inflated even when they are underinflated.
- Inspect tires for signs of tire wear or visible damage.

### CAUTION!

After inspecting or adjusting the tire pressure, always reinstall the valve stem cap. This will prevent moisture and dirt from entering the valve stem, which could damage the valve stem.

Inflation pressures specified on the placard are always "cold tire inflation pressure". Cold tire inflation pressure is defined as the tire pressure after the vehicle has not been driven for at least 3 hours, or driven less than 1 mile (1.6 km) after sitting for a minimum of 3 hours. The cold tire inflation pressure must not exceed the maximum inflation pressure molded into the tire sidewall.

Check tire pressures more often if subject to a wide range of outdoor temperatures, as tire pressures vary with temperature changes.

Tire pressures change by approximately 1 psi (7 kPa) per 12 °F (7 °C) of air temperature change. Keep this in mind when checking tire pressure inside a garage, especially in the Winter.

Example: If garage temperature = 68 °F (20 °C) and the outside temperature = 32 °F (0 °C) then the cold tire inflation pressure should be increased by 3 psi (21 kPa), which equals 1 psi (7 kPa) for every 12 °F (7 °C) for this outside temperature condition.

Tire pressure may increase from 2 to 6 psi (13 to 40 kPa) during operation. DO NOT reduce this normal pressure build up or your tire pressure will be too low.

## Tire Pressures For High Speed Operation

The manufacturer advocates driving at safe speeds and within posted speed limits. Where speed limits or conditions are such that the vehicle can be driven at high speeds, maintaining correct tire inflation pressure is very important. Increased tire pressure and reduced vehicle loading may be required for high-speed vehicle operation. Refer to an authorized tire dealer or original equipment vehicle dealer for recommended safe operating speeds, loading and cold tire inflation pressures.

### WARNING!

High speed driving with your vehicle under maximum load is dangerous. The added strain on your tires could cause them to fail. You could have a serious collision. Do not drive a vehicle loaded to the maximum capacity at continuous speeds above 75 mph (120 km/h).

## Radial Ply Tires

### WARNING!

Combining radial ply tires with other types of tires on your vehicle will cause your vehicle to handle poorly. The instability could cause a collision. Always use radial ply tires in sets of four. Never combine them with other types of tires.

## Tire Repair

If your tire becomes damaged, it may be repaired if it meets the following criteria:

- The tire has not been driven on when flat.
- The damage is only on the tread section of your tire (sidewall damage is not repairable).
- The puncture is no greater than a ¼ of an inch (6 mm).

Consult an authorized tire dealer for tire repairs and additional information.

Damaged Run Flat tires, or Run Flat tires that have experienced a loss of pressure should be replaced immediately with another Run Flat tire of identical size and service description (Load Index and Speed Symbol). Replace the tire pressure sensor as well as it is not designed to be reused.

### Run Flat Tires — If Equipped

Run Flat tires allow you the capability to drive 50 miles (80 km) at 50 mph (80 km/h) after a rapid loss of inflation pressure. This rapid loss of inflation is referred to as the Run Flat mode. A Run Flat mode occurs when the tire inflation pressure is of/or below 14 psi (96 kPa). Once a Run Flat tire reaches the Run Flat mode it has limited driving capabilities and needs to be replaced immediately. A Run Flat tire is not repairable. When a Run Flat tire is changed after being driven under a Run Flat mode 14 psi (96 kPa) condition, please replace the TPMS sensor as it is not designed to be reused.

#### NOTE:

TPMS Sensor must be replaced after driving the vehicle on a flat tire condition.

It is not recommended driving a vehicle loaded at full capacity or to tow a trailer while a tire is in the Run Flat mode.

See the Tire Pressure Monitoring System section for more information.

### Tire Spinning

When stuck in mud, sand, snow, or ice conditions, do not spin your vehicle's wheels above 30 mph (48 km/h) or for longer than 30 seconds continuously without stopping.

For further information → page 248.

#### WARNING!

Fast spinning tires can be dangerous. Forces generated by excessive wheel speeds may cause tire damage or failure. A tire could explode and injure someone. Do not spin your vehicle's wheels faster than 30 mph (48 km/h) for more than 30 seconds continuously when you are stuck, and do not let anyone near a spinning wheel, no matter what the speed.

### Tread Wear Indicators

Tread wear indicators are in the original equipment tires to help you in determining when your tires should be replaced.

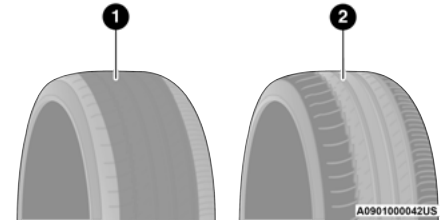

Tire Tread

- 1 — Worn Tire
- 2 — New Tire

These indicators are molded into the bottom of the tread grooves. They will appear as bands when the tread depth becomes a 1/16 of an inch (1.6 mm). When the tread is worn to the tread wear indicators, the tire should be replaced.

## Life Of Tire

The service life of a tire is dependent upon varying factors including, but not limited to:

- Driving style.
- Tire pressure - Improper cold tire inflation pressures can cause uneven wear patterns to develop across the tire tread. These abnormal wear patterns will reduce tread life, resulting in the need for earlier tire replacement.
- Distance driven.
- Performance tires, tires with a speed rating of V or higher, and Summer tires typically have a reduced tread life. Rotation of these tires per the vehicle scheduled maintenance is highly recommended.

### WARNING!

Tires and the spare tire should be replaced after six years, regardless of the remaining tread. Failure to follow this warning can result in sudden tire failure. You could lose control and have a collision resulting in serious injury or death.

### NOTE:

Wheel valve stem must be replaced as well when installing new tires due to wear and tear in existing tires.

Keep dismantled tires in a cool, dry place with as little exposure to light as possible. Protect tires from contact with oil, grease, and gasoline.

## Replacement Tires

The tires on your new vehicle provide a balance of many characteristics. They should be inspected regularly for wear and correct cold tire inflation pressures. The manufacturer strongly recommends that you use tires equivalent to the originals in size, quality and performance when replacement is needed → page 295. Refer to the Tire and Loading Information placard or the Vehicle Certification Label for the size designation of your tire. The Load Index and Speed Symbol for your tire will be found on the original equipment tire sidewall.

See the Tire Sizing Chart example found in the “Tire Safety Information” section of this manual for more information relating to the Load Index and Speed Symbol of a tire → page 285.

It is recommended to replace the two front tires or two rear tires as a pair. Replacing just one tire can seriously affect your vehicle’s handling. If you ever replace a wheel, make sure that the wheel’s specifications match those of the original wheels.

It is recommended you contact an authorized tire dealer or original equipment dealer with any questions you may have on tire specifications or capability.

Failure to use equivalent replacement tires may adversely affect the safety, handling, and ride of your vehicle.

### WARNING!

- Do not use a tire, wheel size, load rating, or speed rating other than that specified for your vehicle. Some combinations of unapproved tires and wheels may change suspension dimensions and performance characteristics, resulting in changes to steering, handling, and braking of your vehicle. This can cause unpredictable handling and stress to steering and suspension components. You could lose control and have a collision resulting in serious injury or death. Use only the tire and wheel sizes with load ratings approved for your vehicle.
- Never use a tire with a smaller load index or capacity, other than what was originally equipped on your vehicle. Using a tire with a smaller load index could result in tire overloading and failure. You could lose control and have a collision.
- Failure to equip your vehicle with tires having adequate speed capability can result in sudden tire failure and loss of vehicle control.

**CAUTION!**

Replacing original tires with tires of a different size may result in false speedometer and odometer readings.

**TIRE TYPES****All Season Tires — If Equipped**

All Season tires provide traction for all seasons (Spring, Summer, Autumn, and Winter). Traction levels may vary between different all season tires. All season tires can be identified by the M+S, M&S, M/S or MS designation on the tire sidewall. Use all season tires only in sets of four; failure to do so may adversely affect the safety and handling of your vehicle.

**Summer Or Three Season Tires — If Equipped**

Summer tires provide traction in both wet and dry conditions, and are not intended to be driven in snow or on ice. If your vehicle is equipped with Summer tires, be aware these tires are not designed for Winter or cold driving conditions. Install Winter tires on your vehicle when ambient temperatures are less than 40°F (5°C) or if roads are covered with ice or snow. For more information, contact an authorized dealer.

Summer tires do not contain the all season designation or mountain/snowflake symbol on the tire sidewall. Use Summer tires only in sets of four; failure to do so may adversely affect the safety and handling of your vehicle.

**WARNING!**

Do not use Summer tires in snow/ice conditions. You could lose vehicle control, resulting in severe injury or death. Driving too fast for conditions also creates the possibility of loss of vehicle control.

**Snow Tires**

Some areas of the country require the use of snow tires during the Winter. Snow tires can be identified by a “mountain/snowflake” symbol on the tire sidewall.



If you need snow tires, select tires equivalent in size and type to the original equipment tires. Use snow tires only in sets of four; failure to do so may adversely affect the safety and handling of your vehicle.

Snow tires generally have lower speed ratings than what was originally equipped with your vehicle and should not be operated at sustained speeds over 75 mph (120 km/h). For speeds above 75 mph (120 km/h) refer to original equipment or an

authorized tire dealer for recommended safe operating speeds, loading and cold tire inflation pressures.

While studded tires improve performance on ice, skid and traction capability on wet or dry surfaces may be poorer than that of non-studded tires. Some states prohibit studded tires; therefore, local laws should be checked before using these tire types.

**SPARE TIRES — IF EQUIPPED****NOTE:**

For vehicles equipped with Tire Service Kit instead of a spare tire, please refer to “Tire Service Kit” in “In Case Of Emergency” for further information.

**CAUTION!**

Because of the reduced ground clearance, do not take your vehicle through an automatic car wash with a compact or limited use temporary spare installed. Damage to the vehicle may result.

For restrictions when towing with a spare tire designated for temporary emergency use  
 ⇨ page 114.

## Spare Tire Matching Original Equipped Tire And Wheel — If Equipped

Your vehicle may be equipped with a spare tire and wheel equivalent in look and function to the original equipment tire and wheel found on the front or rear axle of your vehicle. This spare tire may be used in the tire rotation for your vehicle. If your vehicle has this option, refer to an authorized tire dealer for the recommended tire rotation pattern.

### Compact Spare Tire — If Equipped

The compact spare is for temporary emergency use only. You can identify if your vehicle is equipped with a compact spare by looking at the spare tire description on the Tire and Loading Information Placard located on the driver's side door opening or on the sidewall of the tire. Compact spare tire descriptions begin with the letter "T" or "S" preceding the size designation. Example: T145/80D18 103M.

T, S = Temporary Spare Tire

Since this tire has limited tread life, the original equipment tire should be repaired (or replaced) and reinstalled on your vehicle at the first opportunity.

Do not install a wheel cover or attempt to mount a conventional tire on the compact spare wheel, since the wheel is designed specifically for the compact spare tire. Do not install more than one compact spare tire and wheel on the vehicle at any given time.

#### WARNING!

Compact and collapsible spares are for temporary emergency use only. With these spares, do not drive more than 50 mph (80 km/h). Temporary use spares have limited tread life. When the tread is worn to the tread wear indicators, the temporary use spare tire needs to be replaced. Be sure to follow the warnings, which apply to your spare. Failure to do so could result in spare tire failure and loss of vehicle control.

### Collapsible Spare Tire — If Equipped

The collapsible spare is for temporary emergency use only. You can identify if your vehicle is equipped with a collapsible spare by looking at the spare tire description on the Tire and Loading Information Placard located on the driver's side door opening or on the sidewall of the tire.

Collapsible spare tire description example: 165/80-17 101P.

Since this tire has limited tread life, the original equipment tire should be repaired (or replaced) and reinstalled on your vehicle at the first opportunity.

Inflate collapsible tire only after the wheel is properly installed to the vehicle. Inflate the collapsible tire using the electric air pump before lowering the vehicle.

Do not install a wheel cover or attempt to mount a conventional tire on the collapsible spare wheel, since the wheel is designed specifically for the collapsible spare tire.

#### WARNING!

Compact and Collapsible spares are for temporary emergency use only. With these spares, do not drive more than 50 mph (80 km/h). Temporary use spares have limited tread life. When the tread is worn to the tread wear indicators, the temporary use spare tire needs to be replaced. Be sure to follow the warnings, which apply to your spare. Failure to do so could result in spare tire failure and loss of vehicle control.



### Full Size Spare — If Equipped

The full size spare is for temporary emergency use only. This tire may look like the originally equipped tire on the front or rear axle of your vehicle, but it is not. This spare tire may have limited tread life. When the tread is worn to the tread wear indicators, the temporary use full size spare tire needs to be replaced. Since it is not the same as your original equipment tire, replace (or repair) the original equipment tire and reinstall on the vehicle at the first opportunity.

### Limited Use Spare — If Equipped

The limited use spare tire is for temporary emergency use only. This tire is identified by a label located on the limited use spare wheel. This label contains the driving limitations for this spare. This tire may look like the original equipped tire on the front or rear axle of your vehicle, but it is not. Installation of this limited use spare tire affects vehicle handling. Since it is not the same as your original equipment tire, replace (or repair) the original equipment tire and reinstall on the vehicle at the first opportunity.

#### WARNING!

Limited use spares are for emergency use only. Installation of this limited use spare tire affects vehicle handling. With this tire, do not drive more than the speed listed on the limited use spare wheel. Keep inflated to the cold tire inflation pressures listed on your Tire and Loading Information Placard located on the driver's side B-pillar or the rear edge of the driver's side door. Replace (or repair) the original equipment tire at the first opportunity and reinstall it on your vehicle. Failure to do so could result in loss of vehicle control.

### WHEEL AND WHEEL TRIM CARE

All wheels and wheel trim, especially aluminum and chrome plated wheels, should be cleaned regularly using mild (neutral Ph) soap and water to maintain their luster and to prevent corrosion. Wash wheels with the same soap solution recommended for the body of the vehicle and remember to always wash when the surfaces are not hot to the touch.

Your wheels are susceptible to deterioration caused by salt, sodium chloride, magnesium chloride, calcium chloride, etc., and other road chemicals used to melt ice or control dust on dirt roads. Use a soft cloth or sponge and mild soap to wipe away promptly. Do not use harsh chemicals or a stiff brush. They can damage the wheel's protective coating that helps keep them from corroding and tarnishing.

#### CAUTION!

Avoid products or automatic car washes that use acidic solutions or strong alkaline additives or harsh brushes. Many aftermarket wheel cleaners and automatic car washes may damage the wheel's protective finish. Such damage is not covered by the New Vehicle Limited Warranty. Only car wash soap, Mopar® Wheel Cleaner or equivalent is recommended.

When cleaning extremely dirty wheels including excessive brake dust, care must be taken in the selection of tire and wheel cleaning chemicals and equipment to prevent damage to the wheels. Mopar® Wheel Treatment or Mopar® Chrome Cleaner or their equivalent is recommended or select a non-abrasive, non-acidic cleaner for aluminum or chrome wheels.

#### CAUTION!

Do not use scouring pads, steel wool, a bristle brush, metal polishes or oven cleaner. These products may damage the wheel's protective finish. Such damage is not covered by the New Vehicle Limited Warranty. Only car wash soap, Mopar® Wheel Cleaner or equivalent is recommended.

#### NOTE:

If you intend parking or storing your vehicle for an extended period after cleaning the wheels with wheel cleaner, drive your vehicle and apply the brakes to remove the water droplets from the brake components. This activity will remove the red rust on the brake rotors and prevent vehicle vibration when braking.

#### Dark Vapor Chrome, Black Satin Chrome, or Low Gloss Clear Coat Wheels

#### CAUTION!

If your vehicle is equipped with these specialty wheels, DO NOT USE wheel cleaners, abrasives, or polishing compounds. They will permanently damage this finish and such damage is not covered by the New Vehicle Limited Warranty. HAND WASH ONLY USING MILD SOAP AND WATER WITH A SOFT CLOTH. Used on a regular basis; this is all that is required to maintain this finish.

## SNOW TRACTION DEVICES

Use of traction devices require sufficient tire-to-body clearance. Due to limited clearance, the following snow traction devices are recommended. Follow these recommendations to guard against damage.

- Snow traction device must be of proper size for the tire, as recommended by the snow traction device manufacturer.
- No other tire sizes are recommended for use with the snow traction device.
- Please follow the table for the recommended tire size, axle and snow traction device:

RWD Trim Level	Axle	Tire/Wheel Size	Snow Traction Device (maximum projection beyond tire profile or equivalent)
SXT	Rear	235/55R18	Peerless Chain Super Z6 Low Profile or Equivalent
GT R/T		235/55R18 18 x 7.5 x 24mm	
R/T SCAT PACK	NONE		

AWD Trim Level	Axle	Tire/Wheel Size	Snow Traction Device (maximum projection beyond tire profile or equivalent)
SXT GT	Rear	235/55R19	S Class

**WARNING!**

Using tires of different size and type (M+S, Snow) between front and rear axles can cause unpredictable handling. You could lose control and have a collision.

**CAUTION!**

To avoid damage to your vehicle or tires, observe the following precautions:

- Because of restricted traction device clearance between tires and other suspension components, it is important that only traction devices in good condition are used. Broken devices can cause serious damage. Stop the vehicle immediately if noise occurs that could indicate device breakage. Remove the damaged parts of the device before further use.
- Install device as tightly as possible and then retighten after driving about ½ mile (0.8 km). Autosock traction devices do not require retightening.
- Do not exceed 30 mph (48 km/h).
- Drive cautiously and avoid severe turns and large bumps, especially with a loaded vehicle.
- Do not drive for a prolonged period on dry pavement.

(Continued)

**CAUTION!**

- Observe the traction device manufacturer's instructions on the method of installation, operating speed, and conditions for use. Always use the suggested operating speed of the device manufacturer's if it is less than 30 mph (48 km/h).
- Do not use traction devices on a compact spare tire.

**TIRE ROTATION RECOMMENDATIONS**

Tires on the front and rear axles of vehicles operate at different loads and perform different steering, driving, and braking functions. For these reasons, they wear at unequal rates.

These effects can be reduced by timely rotation of tires. The benefits of rotation are especially worthwhile with aggressive tread designs such as those on all season type tires. Rotation will increase tread life, help to maintain mud, snow and wet traction levels, and contribute to a smooth, quiet ride.

For the proper maintenance intervals ⇨ page 251. The reasons for any rapid or unusual wear should be corrected prior to rotation being performed.

The suggested rotation method is the “rearward cross” shown in the following diagram.

This rotation pattern does not apply to some directional tires that must not be reversed.

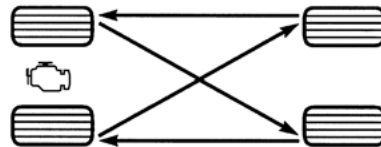

055703771

**Tire Rotation (Rearward Cross)****DEPARTMENT OF TRANSPORTATION  
UNIFORM TIRE QUALITY GRADES**

The following tire grading categories were established by the National Highway Traffic Safety Administration. The specific grade rating assigned by the tire's manufacturer in each category is shown on the sidewall of the tires on your vehicle.

All passenger vehicle tires must conform to Federal safety requirements in addition to these grades.

## TREADWEAR

The Treadwear grade is a comparative rating, based on the wear rate of the tire when tested under controlled conditions on a specified government test course. For example, a tire graded 150 would wear one and one-half times as well on the government course as a tire graded 100. The relative performance of tires depends upon the actual conditions of their use, however, and may depart significantly from the norm due to variations in driving habits, service practices, and differences in road characteristics and climate.

## TRACTION GRADES

The Traction grades, from highest to lowest, are AA, A, B, and C. These grades represent the tire's ability to stop on wet pavement, as measured under controlled conditions on specified government test surfaces of asphalt and concrete. A tire marked C may have poor traction performance.

### WARNING!

The traction grade assigned to this tire is based on straight-ahead braking traction tests, and does not include acceleration, cornering, hydroplaning, or peak traction characteristics.

## TEMPERATURE GRADES

The Temperature grades are A (the highest), B, and C, representing the tire's resistance to the generation of heat and its ability to dissipate heat, when tested under controlled conditions on a specified indoor laboratory test wheel.

Sustained high temperature can cause the material of the tire to degenerate and reduce tire life, and excessive temperature can lead to sudden tire failure. The grade C corresponds to a level of performance, which all passenger vehicle tires must meet under the Federal Motor Vehicle Safety Standard No. 109. Grades B and A represent higher levels of performance on the laboratory test wheel, than the minimum required by law.

### WARNING!

The temperature grade for this tire is established for a tire that is properly inflated and not overloaded. Excessive speed, underinflation, or excessive loading, either separately or in combination, can cause heat buildup and possible tire failure.

## VEHICLE STORAGE

If you are leaving your vehicle dormant for more than 3 weeks, you may want to take these steps to protect your battery.

- Disconnect the negative cable from the battery.
- Anytime you store your vehicle, or keep it out of service (e.g., vacation) for two weeks or more, run the air conditioning system at idle for about five minutes in the fresh air and high blower setting. This will ensure adequate system lubrication to minimize the possibility of compressor damage when the system is started again.

## BODYWORK

### PROTECTION FROM ATMOSPHERIC AGENTS

Vehicle body care requirements vary according to geographic locations and usage. Chemicals that make roads passable in snow and ice and those that are sprayed on trees and road surfaces during other seasons are highly corrosive to the metal in your vehicle. Outside parking, which exposes your vehicle to airborne contaminants, road surfaces on which the vehicle is operated, extreme hot or cold weather and other extreme conditions will have an adverse effect on paint, metal trim, and underbody protection.

The following maintenance recommendations will enable you to obtain maximum benefit from the corrosion resistance built into your vehicle.

#### What Causes Corrosion?

Corrosion is the result of deterioration or removal of paint and protective coatings from your vehicle.

The most common causes are:

- Road salt, dirt and moisture accumulation.
- Stone and gravel impact.
- Insects, tree sap and tar.
- Salt in the air near seacoast localities.
- Atmospheric fallout/industrial pollutants.

### BODY AND UNDERBODY MAINTENANCE

#### Cleaning Headlights

Your vehicle is equipped with plastic headlights and fog lights that are lighter and less susceptible to stone breakage than glass headlights.

Plastic is not as scratch resistant as glass and therefore different lens cleaning procedures must be followed.

To minimize the possibility of scratching the lenses and reducing light output, avoid wiping with a dry cloth. To remove road dirt, wash with a mild soap solution followed by rinsing.

Do not use abrasive cleaning components, solvents, steel wool or other aggressive material to clean the lenses.

## PRESERVING THE BODYWORK

### Washing

- Wash your vehicle regularly. Always wash your vehicle in the shade using Mopar® Car Wash, or a mild car wash soap, and rinse the panels completely with water.
- If insects, tar, or other similar deposits have accumulated on your vehicle, use Mopar® Super Kleen Bug and Tar Remover to remove.
- Use a high quality cleaner wax, such as Mopar® Cleaner Wax to remove road film, stains and to protect your paint finish. Use precautions to not scratch the paint.
- Avoid using abrasive compounds and power buffing that may diminish the gloss or thin out the paint finish.

#### CAUTION!

- Do not use abrasive or strong cleaning materials such as steel wool or scouring powder that will scratch metal and painted surfaces.
- Use of power washers exceeding 1,200 psi (8,274 kPa) can result in damage or removal of paint and decals.

## Special Care

- If you drive on salted or dusty roads or if you drive near the ocean, hose off the undercarriage at least once a month.
- It is important that the drain holes in the lower edges of the doors, rocker panels, and trunk be kept clear and open.
- If you detect any stone chips or scratches in the paint, touch them up immediately.
- If your vehicle is damaged due to a collision or similar cause that destroys the paint and protective coating, have your vehicle repaired as soon as possible.
- If you carry special cargo such as chemicals, fertilizers, de-icer salt, etc., be sure that such materials are well packaged and sealed.
- If a lot of driving is done on gravel roads, consider mud or stone shields behind each wheel.
- Use Mopar® Touch Up Paint on scratches as soon as possible. An authorized dealer has touch up paint to match the color of your vehicle.

## INTERIORS

### SEATS AND FABRIC PARTS

Use Mopar® Total Clean to clean fabric upholstery and carpeting.

#### WARNING!

Do not use volatile solvents for cleaning purposes. Many are potentially flammable, and if used in closed areas they may cause respiratory harm.

### Seat Belt Maintenance

Do not bleach, dye, or clean the belts with chemical solvents or abrasive cleaners. This will weaken the fabric.

If the belts need cleaning, use Mopar® Total Clean, a mild soap solution, or lukewarm water. Do not remove the belts from the vehicle to wash them. Dry with a soft cloth.

Sun damage can also weaken the fabric. Replace the belts if they appear frayed or worn or if the buckles do not work properly.

#### WARNING!

A frayed or torn seat belt could rip apart in a collision and leave you with no protection. Inspect the seat belt system periodically, checking for cuts, frays, or loose parts. Damaged parts must be replaced immediately. Do not disassemble or modify the seat belt system. If your vehicle is involved in a collision, or if you have questions regarding seat belt or retractor conditions, take your vehicle to an authorized FCA dealer or authorized FCA Certified Collision Care Program facility for inspection.

## PLASTIC AND COATED PARTS

Use Mopar® Total Clean to clean vinyl upholstery.

### CAUTION!

- Direct contact of air fresheners, insect repellents, suntan lotions, or hand sanitizers to the plastic, painted, or decorated surfaces of the interior may cause permanent damage. Wipe away immediately.
- Damage caused by these type of products may not be covered by your New Vehicle Limited Warranty.

## Cleaning Plastic Instrument Cluster Lenses

The lenses in front of the instruments in this vehicle are molded in clear plastic. When cleaning the lenses, care must be taken to avoid scratching the plastic.

Clean with a wet soft cloth. A mild soap solution may be used, but do not use high alcohol content or abrasive cleaners. If soap is used, wipe clean with a clean damp cloth. Dry with a soft cloth.

## LEATHER SURFACES

Mopar® Total Clean is specifically recommended for leather upholstery.

Your leather upholstery can be best preserved by regular cleaning with a damp soft cloth. Small particles of dirt can act as an abrasive and damage the leather upholstery and should be removed promptly with a damp cloth. Stubborn soils can be removed easily with a soft cloth and Mopar® Total Clean. Care should be taken to avoid soaking your leather upholstery with any liquid. Please do not use polishes, oils, cleaning fluids, solvents, detergents, or ammonia-based cleaners to clean your leather upholstery.

### NOTE:

If equipped with light colored leather, it tends to show any foreign material, dirt, and fabric dye transfer more so than darker colors. The leather is designed for easy cleaning, and the manufacturer recommends Mopar® total care leather cleaner applied on a cloth to clean the leather seats as needed.

### CAUTION!

Do not use Alcohol and Alcohol-based and/or Ketone based cleaning products to clean leather upholstery, as damage to the upholstery may result.

## GLASS SURFACES

All glass surfaces should be cleaned on a regular basis with Mopar® Glass Cleaner, or any commercial household-type glass cleaner. Never use an abrasive type cleaner. Use caution when cleaning the inside rear window equipped with electric defrosters or windows equipped with radio antennas. Do not use scrapers or other sharp instruments that may scratch the elements.

When cleaning the rear view mirror, spray cleaner on the towel or cloth that you are using. Do not spray cleaner directly on the mirror.



# TECHNICAL SPECIFICATIONS

## VEHICLE IDENTIFICATION NUMBER (VIN)

The VIN is on the left front corner of the instrument panel. The VIN is visible from outside of the vehicle through the windshield.

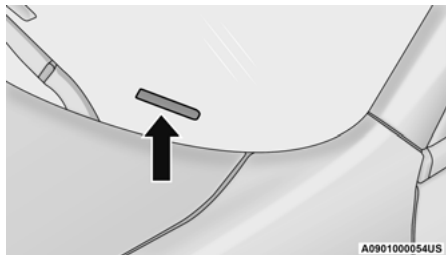

Windshield VIN Location

### NOTE:

It is illegal to remove or alter the VIN.

## BRAKE SYSTEM

Your vehicle is equipped with dual hydraulic brake systems. If either of the two hydraulic systems lose normal capability, the remaining system will still function. There will be some loss of overall braking effectiveness. This may be evident by increased pedal travel during application, greater pedal force required to slow or stop, and potential activation of the Brake Warning Light.

In the event power assist is lost for any reason (for example, repeated brake applications with the engine off), the brakes will still function. The effort required to brake the vehicle will be much greater than that required with the power system operating.

## WHEEL AND TIRE TORQUE SPECIFICATIONS

Proper lug nut/bolt torque is very important to ensure that the wheel is properly mounted to the vehicle. Any time a wheel has been removed and reinstalled on the vehicle, the lug nuts/bolts should be torqued using a properly calibrated torque wrench using a six-sided (hex) deep wall socket.

### TORQUE SPECIFICATIONS

Lug Nut/Bolt Torque	**Lug Nut/Bolt Size	Lug Nut/Bolt Socket Size
130 Ft-Lb (176 N-m)	M14 x 1.50	22 mm

\*\*Use only authorized dealer recommended lug nuts/bolts and clean or remove any dirt or oil before tightening.

Inspect the wheel mounting surface prior to mounting the tire and remove any corrosion or loose particles.

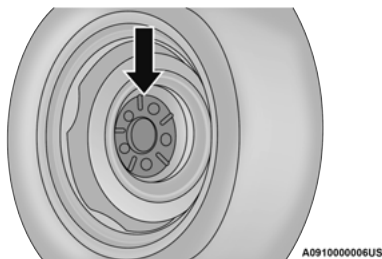

Wheel Mounting Surface

Tighten the lug nuts/bolts in a star pattern until each nut/bolt has been tightened twice. Ensure that the socket is fully engaged on the lug nut/bolt (do not insert it halfway).

#### NOTE:

If in doubt about the correct tightness, have them checked with a torque wrench by an authorized dealer or service station.

After 25 miles (40 km), check the lug nut/bolt torque to be sure that all the lug nuts/bolts are properly tightened.

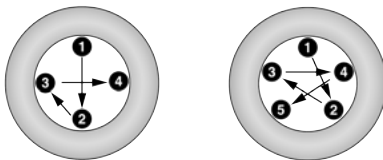

Torque Patterns

#### WARNING!

To avoid the risk of forcing the vehicle off the jack, do not tighten the lug nuts/bolts fully until the vehicle has been lowered. Failure to follow this warning may result in personal injury.

## FUEL REQUIREMENTS

While operating on gasoline with the required octane number, hearing a light knocking sound from the engine is not a cause for concern. However, if the engine is heard making a heavy knocking sound, see a dealer immediately. Use of gasoline with a lower than recommended octane number can cause engine failure and may void the New Vehicle Limited Warranty.

Poor quality gasoline can cause problems such as hard starting, stalling, and hesitations. If you experience these symptoms, try another brand of gasoline before considering service for the vehicle.

### 3.6L ENGINE

Do not use E-85 flex fuel or ethanol blends greater than 15% in this engine.



This engine is designed to meet all emissions regulations and provide excellent fuel economy and performance when using high-quality unleaded regular gasoline having an octane rating of 87 as specified by the (R+M)/2 method. The use of higher octane premium gasoline will not provide any benefit over regular gasoline in these engines.

### 5.7L ENGINE

#### (WITH AUTOMATIC TRANSMISSION)

Do not use E-85 flex fuel or ethanol blends greater than 15% in this engine.



This engine is designed to meet all emissions regulations and provide satisfactory fuel economy and performance when using high quality unleaded gasoline having a posted octane number range of 87 to 89 as specified by the (R+M)/2 method. The use of 89 octane plus gasoline is recommended for optimum performance and fuel economy.

## 5.7L ENGINE (WITH MANUAL TRANSMISSION)

Do not use E-85 flex fuel or ethanol blends greater than 15% in this engine.



This engine is designed to meet all emission regulations, provide optimal fuel economy and performance when using high-quality unleaded premium gasoline having a posted octane number of 91 as specified by the (R+M)/2 method. The use of 91 or higher octane premium gasoline is required for this engine.

### REFORMULATED GASOLINE

Many areas of the country require the use of cleaner-burning gasoline referred to as “reformulated gasoline”. Reformulated gasoline contains oxygenates and are specifically blended to reduce vehicle emissions and improve air quality.

The use of reformulated gasoline is recommended. Properly blended reformulated gasoline will provide improved performance and durability of engine and fuel system components.

## MATERIALS ADDED TO FUEL

Besides using unleaded gasoline with the proper octane rating, gasolines that contain detergents, corrosion and stability additives are recommended. Using gasolines that have these additives will help improve fuel economy, reduce emissions, and maintain vehicle performance.



Designated TOP TIER Detergent Gasoline contains a higher level of detergents to further aide in minimizing engine and fuel system deposits. When available, the usage of TOP TIER Detergent gasoline is recommended. Visit [www.toptiergas.com](http://www.toptiergas.com) for a list of TOP TIER Detergent Gasoline Retailers.

Indiscriminate use of fuel system cleaning agents should be avoided. Many of these materials intended for gum and varnish removal may contain active solvents or similar ingredients. These can harm fuel system gasket and diaphragm materials.

## GASOLINE/OXYGENATE BLENDS

Some fuel suppliers blend unleaded gasoline with oxygenates such as ethanol.

### CAUTION!

DO NOT use E-85, gasoline containing methanol, or gasoline containing more than 15% ethanol (E-15). Use of these blends may result in starting and drivability problems, damage critical fuel system components, cause emissions to exceed the applicable standard, and/or cause the Malfunction Indicator Light to illuminate. Please observe pump labels as they should clearly communicate if a fuel contains greater than 15% ethanol (E-15).

Problems that result from using gasoline containing more than 15% ethanol (E-15) or gasoline containing methanol are not the responsibility of the manufacturer and may void or not be covered under New Vehicle Limited Warranty.

## Do Not Use E-85 in Non-Flex Fuel Vehicles

Non-Flex Fuel Vehicles (FFV) are compatible with gasoline containing up to 15% ethanol (E-15). Use of gasoline with higher ethanol content may void the New Vehicle Limited Warranty.

If a Non-FFV vehicle is inadvertently fueled with E-85 fuel, the engine will have some or all of these symptoms:

- Operate in a lean mode.
- OBD II Malfunction Indicator Light on.
- Poor engine performance.
- Poor cold start and cold drivability.
- Increased risk for fuel system component corrosion.

## CNG and LP Fuel System Modifications

Modifications that allow the engine to run on Compressed Natural Gas (CNG) or Liquid Propane (LP) may result in damage to the engine, emissions, and fuel system components. Problems that result from running CNG or LP are not the responsibility of the manufacturer and may void or not be covered under the New Vehicle Limited Warranty.

## Methylcyclopentadienyl Manganese Tricarbonyl (MMT) in Gasoline

MMT is a manganese-containing metallic additive that is blended into some gasoline to increase octane. Gasoline blended with MMT provides no performance advantage beyond gasoline of the same octane number without MMT. Gasoline blended with MMT reduces spark plug life and reduces emissions system performance in some vehicles. The manufacturer recommends that gasoline without MMT be used in your vehicle. The MMT content of gasoline may not be indicated on the gasoline pump; therefore, you should ask your gasoline retailer whether the gasoline contains MMT. MMT is prohibited in Federal and California reformulated gasoline.

## Fuel System Cautions

CAUTION!
<p>Follow these guidelines to maintain your vehicle's performance:</p> <ul style="list-style-type: none"> <li>● The use of leaded gasoline is prohibited by Federal law. Using leaded gasoline can impair engine performance and damage the emissions control system.</li> </ul>

*(Continued)*

CAUTION!
<ul style="list-style-type: none"> <li>● An out-of-tune engine or certain fuel or ignition malfunctions can cause the catalytic converter to overheat. If you notice a pungent burning odor or some light smoke, your engine may be out of tune or malfunctioning and may require immediate service. Contact an authorized dealer for service assistance.</li> <li>● The use of fuel additives, which are now being sold as octane enhancers, is not recommended. Most of these products contain high concentrations of methanol. Fuel system damage or vehicle performance problems resulting from the use of such fuels or additives is not the responsibility of the manufacturer and may void or not be covered under the New Vehicle Limited Warranty.</li> </ul>

### NOTE:

Intentional tampering with the emissions control system can result in civil penalties being assessed against you.

## FLUID CAPACITIES

	US	Metric
<b>Fuel (Approximate)</b>		
All Engines	18.5 Gallons	70 Liters
<b>Engine Oil With Filter</b>		
3.6L Engine	6 Quarts	5.6 Liters
5.7L Engine	7 Quarts	6.6 Liters
<b>Cooling System*</b>		
3.6L Engine	11.1 Quarts	10.5 Liters
5.7L Engine	14.7 Quarts	13.9 Liters
* Includes heater and coolant recovery bottle filled to MAX level.		

## ENGINE FLUIDS AND LUBRICANTS

Component	Fluid, Lubricant, or Genuine Part
Engine Coolant	We recommend you use Mopar® Antifreeze/Coolant 10 Year/150,000 Mile (240,000 km) Formula OAT (Organic Additive Technology).
Engine Oil – 3.6L/5.7L Engine	We recommend you use API Certified SAE 5W-20 Engine Oil, meeting the requirements of the manufacturer Material Standard MS-6395 such as Mopar® SAE 5W-20, Pennzoil SAE 5W-20, and Pennzoil gold 5W-20 semi-synthetic oil. Refer to your engine oil filler cap for correct SAE grade.
Engine Oil Filter	We recommend you use a Mopar® Engine Oil Filter. If a Mopar® Engine Oil Filter is unavailable only use filters that meet or exceed SAE/USCAR-36 Filter Performance Requirements.
Fuel Selection – 3.6L Engine	87 Octane (R+M)/2 Method, 0-15% ethanol.
Fuel Selection – 5.7L Engine With Automatic Transmission	89 Octane recommended – 87 Octane acceptable (R+M)/2 Method, 0-15% ethanol.
Fuel Selection – 5.7L Engine With Manual Transmission	91 Octane or higher (R+M)/2 Method, 0-15% ethanol.

**CAUTION!**

- Mixing of engine coolant (antifreeze) other than specified Organic Additive Technology (OAT) engine coolant (antifreeze), may result in engine damage and may decrease corrosion protection. Organic Additive Technology (OAT) engine coolant is different and should not be mixed with Hybrid Organic Additive Technology (HOAT) engine coolant (antifreeze) or any “globally compatible” coolant (antifreeze). If a non-OAT engine coolant (antifreeze) is introduced into the cooling system in an emergency, the cooling system will need to be drained, flushed, and refilled with fresh OAT coolant (conforming to MS.90032), by an authorized dealer as soon as possible.
- Do not use water alone or alcohol-based engine coolant (antifreeze) products. Do not use additional rust inhibitors or antirust products, as they may not be compatible with the radiator engine coolant and may plug the radiator.
- This vehicle has not been designed for use with propylene glycol-based engine coolant (antifreeze). Use of propylene glycol-based engine coolant (antifreeze) is not recommended.

## CHASSIS FLUIDS AND LUBRICANTS

Component	Fluid, Lubricant, or Genuine Part
Automatic Transmission – If Equipped	Use only Mopar® ZF 8 & 9 Speed ATF Automatic Transmission Fluid, or equivalent. Failure to use the correct fluid may affect the function or performance of your transmission.
Manual Transmission – If Equipped	We recommend you use Mopar® ATF+4 Automatic Transmission Fluid.
Brake Master Cylinder	We recommend you use Mopar® DOT 3, SAE J1703.
Front Axle – AWD (If Equipped)	We recommend you use Mopar® Synthetic Gear Lubricant SAE 75W90 (API GL-5).
Rear Axle – 3.6L/5.7L Engine With Automatic Transmission	We recommend you use Mopar® OD Synthetic Gear Lubricant SAE 75W85 (API GL-5).
Rear Axle – 5.7L Engine With Manual Transmission	We recommend you use Mopar® LSD Synthetic Gear Lubricant SAE 75W85 (API GL-5).
Transfer Case – AWD (If Equipped)	We recommend you use Mopar® Transfer Case Lubricant for Borg Warner 44-40.



## CUSTOMER ASSISTANCE

### SUGGESTIONS FOR OBTAINING SERVICE FOR YOUR VEHICLE

#### PREPARE FOR THE APPOINTMENT

All work to be performed may not be covered by the warranty. Discuss additional charges with the service manager. Keep a maintenance log of your vehicle's service history. This can often provide a clue to the current problem.

#### PREPARE A LIST

Make a written list of your vehicle's problems or the specific work you want done. If you've had an accident or work done that is not on your maintenance log, let the service advisor know.

#### BE REASONABLE WITH REQUESTS

If you list a number of items and you must have your vehicle by the end of the day, discuss the situation with the service advisor and list the items in order of priority. At many authorized dealers, you may obtain a rental vehicle (additional charges may apply). If you need a rental, it is advisable to make these arrangements when you call for an appointment.

### IF YOU NEED ASSISTANCE

FCA US LLC and its authorized dealers are vitally interested in your satisfaction. We want you to be happy with our products and services.

Warranty service must be done by an authorized dealer. We strongly recommend that you take the vehicle to an authorized dealer. They know your vehicle the best, and are most concerned that you get prompt and high quality service. FCA US LLC's authorized dealers have the facilities, factory-trained technicians, special tools, and the latest information to ensure the vehicle is fixed correctly and in a timely manner.

This is why you should always talk to an authorized dealer's service manager first. If for some reason you are still not satisfied, talk to the general manager or owner of the authorized dealer. They want to know if you need assistance. If an authorized dealer is unable to resolve the concern, you may contact the FCA US LLC's Customer Assistance center.

Any communication to FCA US LLC's customer center should include the following information:

- Owner's name and address
- Owner's telephone number (home, mobile, and office)
- Authorized dealer name
- Vehicle Identification Number (VIN)
- Vehicle delivery date and mileage

#### FCA US LLC CUSTOMER CENTER

P.O. Box 21-8004

Auburn Hills, MI 48321-8004

Phone: (800) 423-6343

#### FCA CANADA INC. CUSTOMER CENTER

P.O. Box 1621

Windsor, Ontario N9A 4H6

Phone: (800) 465-2001 English /  
(800) 387-9983 French

## MEXICO

Av. Prolongacion Paseo de la Reforma, 1240

Sante Fe C.P. 05109

Mexico, D.F.

In Mexico City: (800) 505-1300

Outside Mexico City: +(52) 55 50817568

## PUERTO RICO AND US VIRGIN ISLANDS

FCA Caribbean LLC

P.O. Box 191857

San Juan 00919-1857

Phone: (800) 423-6343

Fax: (787) 782-3345

## CUSTOMER ASSISTANCE FOR THE HEARING OR SPEECH IMPAIRED (TDD/TTY)

To assist customers who have hearing difficulties, FCA US LLC has installed special TDD (Telecommunication Devices for the Deaf) equipment at its customer center. Any hearing or speech impaired customer, who has access to a TDD or a conventional teletypewriter (TTY) in the United States, can communicate with FCA US LLC by dialing 1-800-380-2479.

Canadian residents with hearing difficulties that require assistance can use the special needs relay service offered by Bell Canada. For TTY teletypewriter users, dial 711 and for Voice callers, dial 1-800-855-0511 to connect with a Bell Relay Service operator.

## SERVICE CONTRACT

You may have purchased a service contract for a vehicle to help protect you from the high cost of unexpected repairs after FCA US LLC's New Vehicle Limited Warranty expires. The Mopar® Vehicle Protection plans are the ONLY vehicle extended protection plans authorized, endorsed and backed by FCA US LLC to provide additional protection beyond your vehicle's warranty. If you purchased a Mopar® Vehicle Protection Plan, you will receive Plan Provisions and an Owner Identification Card in the mail within three weeks of the vehicle delivery date. If you have any questions about the service contract, call the FCA US LLC's Service Contract National Customer Hotline at 1-800-521-9922 (Canadian residents, call (800) 465-2001 English / (800) 387-9983 French).

FCA US LLC is not responsible for any service contract you may have purchased from another manufacturer. If you require service after the FCA US LLC New Vehicle Limited Warranty expires, please refer to the contract documents, and contact the person listed in those documents.

We appreciate that you have made a major investment when you purchased the vehicle. An authorized dealer has also made a major investment in facilities, tools, and training to ensure that you are absolutely delighted with the ownership experience.

### WARNING!

Engine exhaust (internal combustion engines only), some of its constituents, and certain vehicle components contain, or emit, chemicals known to the State of California to cause cancer and birth defects, or other reproductive harm. In addition, certain fluids contained in vehicles and certain products of component wear contain, or emit, chemicals known to the State of California to cause cancer and birth defects, or other reproductive harm.

## WARRANTY INFORMATION

See the Warranty Information for the terms and provisions of FCA US LLC warranties applicable to this vehicle and market. Refer to [www.mopar.com/om](http://www.mopar.com/om) for further information.

See the Warranty Information for the terms and provisions of FCA Canada Inc. warranties applicable to this vehicle and market.

Use this QR code to access your digital experience.



## MOPAR® PARTS

Mopar® original equipment parts & accessories and factory filled fluids are available from an authorized dealer. They are recommended for your vehicle to keep it operating at its best and maintain its original condition.

## REPORTING SAFETY DEFECTS

### IN THE 50 UNITED STATES AND WASHINGTON, D.C.

If you believe that your vehicle has a defect that could cause a crash or cause injury or death, you should immediately inform the National Highway Traffic Safety Administration (NHTSA) in addition to notifying FCA US LLC.

If NHTSA receives similar complaints, it may open an investigation, and if it finds that a safety defect exists in a group of vehicles, it may order a recall and remedy campaign. However, NHTSA cannot become involved in individual problems between you, an authorized dealer or FCA US LLC.

To contact NHTSA, you may call the Vehicle Safety Hotline toll free at 1-888-327-4236 (TTY: 1-800-424-9153); or go to <http://www.safercar.gov>; or write to: Administrator, NHTSA, 1200 New Jersey Avenue, SE., West Building, Washington, D.C. 20590. You can also obtain other information about motor vehicle safety from <http://www.safercar.gov>.

### IN CANADA

If you believe that your vehicle has a safety defect, you should contact the Customer Service Department immediately. Canadian customers who wish to report a safety defect to the Canadian government should contact Transport Canada, Motor Vehicle Defect Investigations and Recalls at 1-800-333-0510 or go to [www.apps.tc.gc.ca/Saf-Sec-Sur/7/PCDB-BDPP](http://www.apps.tc.gc.ca/Saf-Sec-Sur/7/PCDB-BDPP).

## PUBLICATION ORDER FORMS

To order the following manuals, you may use either the website or the phone numbers listed below.

### Service Manuals

These comprehensive Service Manuals provide a complete working knowledge of the vehicle, system, and/or components and is written in straightforward language with illustrations, diagrams, and charts.

### Diagnostic Procedure Manuals

Diagnostic Procedure Manuals are filled with diagrams, charts and detailed illustrations. These manuals make it easy to find and fix problems on computer-controlled vehicle systems and features. They show exactly how to find and correct problems, using step-by-step troubleshooting and drivability procedures, proven diagnostic tests and a complete list of all tools and equipment.

To order a hard copy of your Service or Diagnostic Procedure manuals, visit:

[www.techauthority.com](http://www.techauthority.com) (US and Canada).

### Owner's Manuals

These Owner's Manuals have been prepared with the assistance of service and engineering specialists to acquaint you with specific FCA vehicles.

To access your Owner's Information online, visit [www.mopar.com/om](http://www.mopar.com/om) (US) or [www.owners.mopar.ca](http://www.owners.mopar.ca) (Canada).

Or

Call Tech Authority toll free at:

- **1-800-890-4038 (US)**

Owner's Manuals, Radio Manuals and Warranty Information Books can be ordered through Archway at:

- **1-800-387-1143 (Canada)**

## GENERAL INFORMATION

The following regulatory statement applies to all Radio Frequency (RF) devices equipped in this vehicle:

This device complies with Part 15 of the FCC Rules and with Innovation, Science and Economic Development Canada license-exempt RSS standard(s). Operation is subject to the following two conditions:

1. This device may not cause harmful interference, and
2. This device must accept any interference received, including interference that may cause undesired operation.

Le présent appareil est conforme aux CNR d'Innovation, Science and Economic Development applicables aux appareils radio exempts de licence. L'exploitation est autorisée aux deux conditions suivantes:

1. l'appareil ne doit pas produire de brouillage, et
2. l'utilisateur de l'appareil doit accepter tout brouillage radioélectrique subi, même si le brouillage est susceptible d'en compromettre le fonctionnement.



La operación de este equipo está sujeta a las siguientes dos condiciones:

1. es posible que este equipo o dispositivo no cause interferencia perjudicial y
2. este equipo o dispositivo debe aceptar cualquier interferencia, incluyendo la que pueda causar su operación no deseada.

### NOTE:

Changes or modifications not expressly approved by the party responsible for compliance could void the user's authority to operate the equipment.

# INDEX

- A**
- About Your Brakes ..... 82, 307
  - ACC (Adaptive Cruise Control) ..... 93
  - Adaptive Cruise Control (ACC) ..... 93
  - Adding Engine Coolant (Antifreeze) ..... 269
  - Adding Washing Fluid ..... 258
  - Additives, Fuel ..... 309
  - Adjust
    - Forward ..... 30, 32
    - Rearward ..... 30, 32
  - Advance Phone Connectivity ..... 158
  - Air Bag ..... 203
    - Advance Front Air Bag ..... 203
    - Air Bag Operation ..... 204
    - Air Bag Warning Light ..... 202
    - Enhanced Accident Response ..... 209, 250
    - Event Data Recorder (EDR) ..... 250
    - Front Air Bag ..... 203
    - If Deployment Occurs ..... 208
    - Knee Impact Bolsters ..... 205
    - Maintaining Your Air Bag System ..... 210
    - Maintenance ..... 210
    - Redundant Air Bag Warning Light ..... 203
    - Side Air Bags ..... 205
    - Transporting Pets ..... 226
  - Air Bag Light ..... 69, 202, 227
  - Air Cleaner, Engine
    - (Engine Air Cleaner Filter) ..... 262
  - Air Conditioner Maintenance ..... 263
  - Air Conditioner Refrigerant ..... 263
  - Air Conditioner System ..... 263
  - Air Conditioning ..... 48
    - Air Conditioning Filter ..... 52, 263
    - Air Conditioning System ..... 48
    - Air Conditioning, Operating Tips ..... 52
    - Air Filter ..... 262
  - Air Pressure
    - Tires ..... 294
  - Alarm
    - Arm The System ..... 20, 21
    - Rearm The System ..... 21
    - Security Alarm ..... 20, 72
  - Alarm System
    - Security Alarm ..... 20
  - All Wheel Drive (AWD) ..... 273
  - Alterations/Modifications
    - Vehicle ..... 9
  - Android Auto ..... 160, 161
  - Android Auto™  ..... 160
  - Antifreeze (Engine Coolant) ..... 269, 311
    - Disposal ..... 270
  - Anti-Lock Brake System (ABS) ..... 179
  - Anti-Lock Warning Light ..... 72
  - Apple CarPlay ..... 160, 164
  - Apple CarPlay®  ..... 162
  - Arming System
    - Security Alarm ..... 20
  - Assist, Hill Start ..... 184
  - Audio Settings ..... 145
  - Audio Systems (Radio) ..... 119
  - Auto Down Power Windows ..... 56
  - Automatic Door Locks ..... 24, 25
  - Automatic Headlights ..... 43
  - Automatic High Beams ..... 43
  - Automatic Temperature Control (ATC) ..... 51
  - Automatic Transmission ..... 87
    - Adding Fluid ..... 273, 314
    - Fluid And Filter Change ..... 273
    - Fluid Change ..... 273
    - Fluid Level Check ..... 272, 273
    - Fluid Type ..... 273, 314
    - Special Additives ..... 272
  - Automatic Transmission Limp
    - Home Mode ..... 24, 90
    - AutoPark ..... 80

Autostick		Break-In Recommendations, New Vehicle .....	82	Child Restraints	
Operation .....	91	Brightness, Interior Lights .....	46	Booster Seats .....	214
Axle Fluid .....	314	Bulb Replacement .....	282	Child Seat Installation .....	224
Axle Lubrication .....	314	Bulbs, Light .....	228, 282	How To Stow An unused ALR Seat Belt .....	220
<b>B</b>		<b>C</b>		Infant And Child Restraints .....	213
Back-Up .....	107	Camera, Rear .....	107	Lower Anchors And Tethers	
Battery .....	70, 259	Capacities, Fluid .....	311	For Children .....	216
Charging System Light .....	70	Caps, Filler		Older Children And Child Restraints .....	213
Keyless Key Fob Replacement .....	14	Fuel .....	108	Seating Positions .....	215
Location .....	259	Oil (Engine) .....	256	Clean Air Gasoline .....	309
Belts, Seat .....	226	Radiator (Coolant Pressure) .....	270	Cleaning	
Blind Spot Monitoring .....	185	Car Washes .....	304	Wheels .....	299
Bluetooth		Carbon Monoxide Warning .....	229	Climate Control .....	48
Connecting To A Particular Mobile		Cargo		Cold Weather Operation .....	81
Phone Or Audio Device After Pairing .....	153	Vehicle Loading .....	109	Compact Spare Tire .....	298
Body Mechanism Lubrication .....	265	CD .....	147	Contract, Service .....	316
B-Pillar Location .....	290	Cellular Phone .....	178	Controls .....	138
Brake Assist System .....	180	Certification Label .....	109	Cooling Pressure Cap (Radiator Cap) .....	270
Brake Control System .....	180	Chains, Tire .....	300	Cooling System .....	268
Brake Fluid .....	271, 314	Chart, Tire Sizing .....	287	Adding Coolant (Antifreeze) .....	269
Brake System .....	271, 307	Check Engine Light		Coolant Level .....	268, 270
Fluid Check .....	271, 314	(Malfunction Indicator Light) .....	77	Cooling Capacity .....	311
Master Cylinder .....	271	Checking Your Vehicle For Safety .....	226	Disposal Of Used Coolant .....	270
Parking .....	82	Checks, Safety .....	226	Drain, Flush, And Refill .....	268
Warning Light .....	70, 307	Child Restraint .....	211	Inspection .....	270
Brake/Transmission Interlock .....	87			Points To Remember .....	270
				Pressure Cap .....	270

Radiator Cap .....	270	Door Ajar.....	71	Engine.....	256, 257
Selection Of Coolant		Door Ajar Light .....	71	Air Cleaner .....	262
(Antifreeze) .....	269, 311, 312	Door Locks		Block Heater .....	81
Corrosion Protection .....	304	Automatic .....	25	Break-In Recommendations .....	82
Cruise Control.....	93	Doors .....	21	Checking Oil Level .....	258
Cruise Control (Speed Control) .....	93	Drag & Drop.....	136	Compartment .....	256, 257
Cruise Light .....	75, 76	Drive Modes.....	173	Compartment Identification.....	256
Customer Assistance .....	315	Driver Memory Presets .....	144	Coolant (Antifreeze) .....	268
Customer Programmable Features.....	120	Driver's Seat Back Tilt.....	29, 30	Cooling.....	268
Cybersecurity.....	119	Driving		Exhaust Gas Caution .....	229
<b>D</b>		Through Flowing, Rising, Or Shallow		Fails To Start.....	81
Daytime Running Lights.....	42	Standing Water .....	117	Flooded, Starting .....	81
Dealer Service .....	260	<b>E</b>		Fuel Requirements .....	308
Deck Lid		Electric Brake Control System.....	180	Jump Starting .....	243, 244
Power Release .....	59	Anti-Lock Brake System.....	179	Oil .....	260, 311, 312
Defroster, Windshield .....	227	Electronic Roll Mitigation.....	181, 185	Oil Filler Cap .....	256
Delay (Intermittent) Wipers.....	47	Electric Remote Mirrors .....	38	Oil Filter .....	261
Deleting A Phone .....	154	Electrical Power Outlets .....	54	Oil Selection.....	260, 311
Diagnostic System, Onboard .....	76	Electronic Power Distribution		Oil Synthetic.....	260
Dimmer Switch		Center (Fuses) .....	275	Overheating .....	245
Headlight.....	42	Electronic Speed Control (Cruise Control).....	94	Starting .....	78, 79
Dipsticks		Electronic Stability Control (ESC) .....	181	Enhanced Accident Response	
Oil (Engine).....	258	Electronic Throttle Control Warning Light.....	71	Feature .....	209, 250
Disabled Vehicle Towing.....	249	Emergency, In Case Of		Ethanol.....	309
Disc Drive .....	147	Freeing Vehicle When Stuck .....	248	Exhaust Gas Cautions .....	229
Disconnecting.....	154	Jacking .....	234	Exhaust System .....	229, 267
Disposal		Jump Starting .....	243, 244	Exterior Lighting .....	41
Antifreeze (Engine Coolant).....	270	Towing.....	249	Exterior Lights .....	41, 228
Disturb.....	156	Emission Control System Maintenance .....	77		

<b>F</b>		
Filler Location Fuel .....	108	
Filters		
Air Cleaner.....	262	
Air Conditioning.....	52, 263	
Engine Oil .....	261, 312	
Engine Oil Disposal .....	261	
Flashers.....	230	
Hazard Warning.....	230	
Turn Signals .....	44, 75, 228	
Flash-To-Pass .....	43	
Flooded Engine Starting .....	81	
Fluid Capacities .....	311	
Fluid Leaks .....	229	
Fluid Level Checks		
Brake .....	271	
Cooling System.....	268	
Engine Oil .....	258	
Transfer Case.....	273	
Fluid, Brake .....	314	
Fog Lights .....	44	
Fold-Flat Seats.....	29, 31	
Forward Collision Warning.....	189	
Freeing A Stuck Vehicle .....	248	
Fuel .....	308	
Additives .....	309	
Clean Air.....	309	
Ethanol.....	309	
Filler Cap (Gas Cap).....	108	
Gasoline .....	308	
Materials Added .....	309	
Methanol .....	309	
Octane Rating.....	308, 312	
Requirements.....	308	
Specifications.....	312	
Tank Capacity.....	311	
Fueling.....	108	
Fuses .....	274	
<b>G</b>		
Garage Door Opener (HomeLink).....	38	
Gas Cap (Fuel Filler Cap) .....	108	
Gasoline, Clean Air.....	309	
Gasoline, Reformulated .....	309	
Gear Ranges .....	88	
Glass Cleaning.....	306	
Gross Axle Weight Rating.....	109, 110	
Gross Vehicle Weight Rating.....	109, 110	
GVWR.....	109	
<b>H</b>		
Hazard		
Driving Through Flowing, Rising, Or Shallow Standing Water .....	117	
Hazard Warning Flashers.....	230	
Head Restraints .....	35	
Head Rests .....	35	
Headlights		
Automatic .....	43	
Cleaning .....	304	
High Beam/Low Beam Select Switch .....	42	
Lights On Reminder .....	44	
On With Wipers .....	43	
Passing.....	43	
Switch.....	41	
Time Delay.....	44	
Washers.....	258	
Heated Mirrors.....	38	
Heated Seats .....	33	
Heater.....	48	
Heater, Engine Block.....	81	
High Beam/Low Beam Select (Dimmer) Switch .....	42	
Hill Start Assist.....	184	
Hitches		
Trailer Towing .....	112	
HomeLink (Garage Door Opener).....	38	
Hood Prop .....	58	
Hood Release.....	58	
<b>I</b>		
Ignition .....	16	
Switch.....	16	
Information Center, Vehicle .....	63	
Inside Rearview Mirror .....	36, 230	
Instrument Cluster		
Descriptions.....	61, 75	
Display.....	62, 65	
Instrument Cluster Display		
Audio .....	67	



Driver Assist .....	66	<b>L</b>		Intensity Control .....	46
Fuel Economy .....	67	Lane Change And Turn Signals .....	44	Interior .....	45
Speedometer .....	65	Lane Change Assist .....	44	License .....	285
Vehicle Info .....	65	Lap/Shoulder Belts.....	197	Lights On Reminder .....	44
Instrument Panel Lens Cleaning.....	306	Latches .....	229	Malfunction Indicator (Check Engine).....	73
Interior Appearance Care.....	305	Hood.....	58	Map .....	45
Interior Lights .....	45	Lead Free Gasoline.....	308	Park.....	43, 75
Intermittent Wipers (Delay Wipers).....	47	Leaks, Fluid .....	229	Passing.....	43
iPod/USB/MP3 Control .....	54	Life Of Tires.....	296	Reading .....	45
Bluetooth Streaming Audio .....	54	Light Bulbs.....	228, 282	Seat Belt Reminder .....	70
<b>J</b>		Lights .....	228	Security Alarm .....	72
Jack Location.....	234	Air Bag.....	69, 202, 227	Service.....	282
Jack Operation.....	235	Automatic Headlights .....	43	Traction Control.....	183
Jacking Instructions.....	235	Brake Assist Warning .....	183	Turn Signals.....	42, 44, 75, 228
Jump Starting .....	243, 244	Brake Warning.....	70, 307	Vanity Mirror .....	37
<b>K</b>		Bulb Replacement.....	282	Warning Instrument Cluster	
Key Fob		Courtesy/Reading .....	45	Descriptions .....	71, 75
Arm The System .....	20	Cruise .....	75, 76	Load Shed Battery Saver On .....	68
Programming Additional Key Fobs .....	15	Daytime Running.....	42	Load Shed Electrical Load Reduction .....	68
Unlatch The Trunk .....	14	Dimmer Switch, Headlight.....	42	Load Shed Intelligent Battery Sensor.....	68
Key Fob Battery Service		Electronic Stability Program(ESP)		Loading Vehicle.....	109, 110
(Remote Keyless Entry) .....	14	Indicator.....	71	Capacities.....	110
Key Fob Programming		Exterior.....	41, 228	Tires.....	290
(Remote Keyless Entry) .....	15	Fog.....	44	<b>Locks</b>	
Keyless Enter 'n Go™.....	22	Headlight Switch.....	41	Auto Unlock .....	24
Enter The Trunk.....	14	Headlights .....	41, 44	Automatic Door.....	25
Keys.....	13	Headlights On With Wipers.....	43	Power Door .....	22
Replacement.....	15	High Beam.....	42	Low Tire Pressure System .....	191
		High Beam/Low Beam Select.....	42	Lubrication, Body .....	265
		Instrument Cluster.....	41	Lug Nuts/Bolts.....	307

<b>M</b>			
Maintenance .....	58	Modifications/Alterations	
Maintenance Free Battery .....	259	Vehicle.....	9
Maintenance Schedule.....	251, 252	Monitor, Tire Pressure System.....	191
Malfunction Indicator Light (Check Engine).....	73	Mopar Parts.....	317
Manual		Multi-Function Control Lever.....	42
Backward .....	30	<b>N</b>	
Forward.....	30	New Vehicle Break-In Period.....	82
Park Release.....	246	<b>O</b>	
Rearward.....	30	Occupant Restraints .....	194
Service .....	318	Octane Rating, Gasoline (Fuel) .....	308, 312
Tilt .....	30	Oil Change Indicator .....	64
Manual Transmission .....	83, 272, 273	Reset.....	64
Fluid Level Check.....	272, 273	Oil Filter, Change .....	261
Map/Reading Lights.....	45	Oil Filter, Selection.....	261
Media Mode .....	147	Oil Pressure Light.....	71
Memory Seat .....	28	Oil, Engine.....	260, 312
Memory Settings .....	28	Capacity.....	311
Methanol .....	309	Checking.....	258
Mirrors.....	36	Dipstick .....	258
Electric Powered .....	38	Disposal .....	261
Electric Remote.....	38	Filter .....	261, 312
Heated .....	38	Filter Disposal.....	261
Outside.....	37	Identification Logo.....	260
Rearview .....	36, 230	Materials Added To .....	261
Vanity .....	37	Pressure Warning Light .....	71
		Recommendation.....	260, 311
		Synthetic.....	260
		Viscosity.....	311
		Onboard Diagnostic System.....	76
		Operating Precautions .....	76
		Operator Manual	
		Owner's Manual.....	318
		Outside Rearview Mirrors.....	37
		Overheating, Engine.....	245
		<b>P</b>	
		Paddle Shift Mode .....	91
		Paddle Shifters .....	91
		Paint Care .....	304
		Pair (Link) Uconnect Phone To A	
		Mobile Phone  .....	151
		Parking Brake .....	82
		ParkSense System, Rear.....	103
		Passenger Seat	
		Easy Entry.....	34
		Passing Light.....	43
		Performance .....	66
		Performance Shift Indicator .....	65
		Personalized Main Menu Bar .....	136
		Pets.....	226
		Phone Mode.....	149
		Pinch Protection.....	57
		Placard, Tire And Loading Information .....	290

Power			
Brakes.....	307		
Deck Lid Release .....	59		
Distribution Center (Fuses) .....	278		
Door Locks .....	22		
Mirrors.....	38		
Outlet (Auxiliary Electrical Outlet) .....	54		
Seats .....	32		
Steering.....	92		
Sunroof .....	56		
Tilt/Telescoping Steering Column .....	25		
Windows.....	56		
Power Seats			
Forward.....	32		
Lumbar.....	32		
Rearward.....	32		
Power Steering Fluid.....	314		
Pregnant Women And Seat Belts.....	200		
Preparation For Jacking.....	234		
Presets .....	144		
Pretensioners			
Seat Belts.....	200		
Programmable Features.....	120		
<b>R</b>			
Radial Ply Tires .....	294		
Radiator Cap (Coolant Pressure Cap) .....	270		
Radio			
Presets .....	144		
Radio Controls .....	138		
Radio Mode .....	138		
Radio Operation.....	138, 178		
Radio Remote Controls.....	137		
Rain Sensitive Wiper System .....	48		
Rear Camera.....	107		
Rear ParkSense System .....	103		
Rear Seats, Folding.....	31		
Recreational Towing .....	116		
Reformulated Gasoline .....	309		
Refrigerant.....	263		
Release, Hood .....	58		
Reminder, Lights On .....	44		
Reminder, Seat Belt.....	196		
Remote Control			
Starting System .....	17		
Remote Keyless Entry.....	13		
Arm The Alarm.....	20		
Programming Additional Key Fobs.....	15		
Unlatch The Trunk .....	14		
Remote Sound System (Radio) Control.....	137		
Remote Starting			
Exit Remote Start Mode .....	19		
Uconnect Customer Programmable			
Features.....	19		
Uconnect Settings .....	19		
Remote Starting System .....	17		
Remote Trunk Release .....	59		
Replacement Bulbs .....	282		
Replacement Keys.....	15		
Replacement Tires.....	296		
Reporting Safety Defects .....	317		
Restraints, Child.....	211		
Restraints, Head .....	35		
Rocking Vehicle When Stuck.....	248		
Rotation, Tires.....	302		
<b>S</b>			
Safety.....	136		
Safety Checks Inside Vehicle .....	226		
Safety Checks Outside Vehicle.....	228		
Safety Defects, Reporting .....	317		
Safety Features.....	136		
Safety Information, Tire.....	285		
Safety Tips .....	226		
Safety, Exhaust Gas .....	229		
Satellite Radio.....	140		
Saved Radio Stations.....	144		
Schedule, Maintenance .....	251, 252		
Seat Belt Reminder.....	70		
Seat Belts .....	195, 226		
Automatic Locking Retractor (ALR) .....	200		
Child Restraints .....	211		
Energy Management Feature .....	200		
Extender .....	200		
Front Seat.....	195, 197, 199		
Inspection .....	226		
Lap/Shoulder Belt Operation.....	199		
Lap/Shoulder Belt Untwisting.....	199		
Lap/Shoulder Belts.....	197		
Operating Instructions .....	199		

Pregnant Women .....	200	Automatic Transmission .....	86, 87	Starting And Operating.....	78, 79
Pretensioners.....	200	Shoulder Belts .....	197	Starting Procedures .....	78, 79
Rear Seat .....	197	Side View Mirror Adjustment.....	37	Steering .....	25
Reminder .....	196	Signals, Turn .....	44, 75, 228	Column Lock.....	25
Seat Belt Extender .....	200	Sirius Satellite Radio.....	140	Power.....	92
Seat Belt Pretensioner .....	200	Favorites.....	142	Tilt Column.....	25
Untwisting Procedure .....	199	Replay .....	142	Wheel, Heated .....	26
Seat Belts Maintenance .....	305	SiriusXM Satellite Radio		Wheel, Tilt.....	25
Seats .....	29, 32, 33, 34	Browse in SXM .....	143	Steering Wheel Audio Controls.....	137
Adjustment.....	29, 30, 32	Favorites.....	142	Steering Wheel Mounted Sound System.....	137
Easy Entry .....	32	Replay .....	142	Storage .....	53, 303
Head Restraints .....	35	Snow Chains (Tire Chains) .....	300	Storage, Vehicle .....	52, 303
Heated .....	33	Snow Tires .....	297	Store Radio Presets .....	144
Height Adjustment.....	32	Spare Tires .....	234, 297, 298, 299	Storing Your Vehicle.....	303
Power .....	32	Specifications		Stuck, Freeing.....	248
Rear Folding.....	29, 31	Fuel (Gasoline) .....	312	Sun Roof .....	56, 58
Seatback Release .....	30, 31	Oil .....	312	Venting .....	57
Tilting .....	29, 30, 32, 34	Speed Control		Supplemental Restraint System - Air Bag ....	203
Vented.....	34	Accel/Decel .....	94	Symbol Glossary.....	10
Ventilated.....	34	Cancel .....	94	Synthetic Engine Oil .....	260
Security Alarm .....	20, 72	Resume .....	94	System, Remote Starting .....	17
Arm The System .....	20	Set.....	94		
Sentry Key (Immobilizer).....	16	Speed Control (Cruise Control) .....	93, 94	<b>T</b>	
Sentry Key Replacement .....	15	Sport Mode .....	92	Telescoping Steering Column.....	25
Service Assistance.....	315	Starting.....	78, 79	Temperature Control, Automatic (ATC).....	51
Service Contract .....	316	Automatic Transmission .....	78	Tilt Steering Column.....	25
Service Manuals.....	318	Button .....	16	Time Delay	
Settings, Audio .....	145	Cold Weather.....	81	Headlight .....	44
Shift Indicator Light .....	85	Engine Fails To Start.....	81	Tire And Loading Information Placard .....	290
Shifting .....	86	Remote.....	17	Tire Markings .....	286

Tire Safety Information .....	285	Towing .....	110	<b>U</b>	
Tire Service Kit .....	238, 239, 240	Disabled Vehicle.....	249	Uconnect	
Tires.....	228, 293, 297, 298, 302	Guide.....	112	Phone Call Features .....	155
Aging (Life Of Tires) .....	296	Recreational.....	116	Things You Should Know About	
Air Pressure.....	293	Weight .....	112	Your Uconnect Phone.....	158
Chains.....	300	Towing Behind A Motorhome.....	116	Uconnect Settings .....	19
Changing.....	234, 235	Traction.....	117	Uconnect Phone.....	151, 153
Compact Spare .....	298	Traction Control .....	185	Answer Or Ignore An Incoming Call –	
General Information .....	293, 297, 298	Trailer Towing .....	110	Call Currently In Progress .....	156
High Speed.....	294	Hitches .....	112	Answer Or Ignore An Incoming Call –	
Inflation Pressure.....	294	Minimum Requirements.....	113	No Call Currently In Progress.....	156
Jacking .....	234, 235	Tips.....	116	Bluetooth Communication Link .....	160
Life Of Tires .....	296	Trailer And Tongue Weight.....	113	Call Continuation .....	157
Load Capacity.....	290	Wiring .....	115	Call Controls .....	155
Pressure Monitoring System		Trailer Towing Guide .....	112	Call Termination .....	157
(TPMS) .....	74, 191	Trailer Weight.....	112	Cancel Command .....	151
Quality Grading.....	302	Transfer Case		Connecting To A Particular Mobile	
Radial.....	294	Fluid .....	273, 314	Phone Or Audio Device After Pairing.....	153
Replacement.....	296	Maintenance .....	273	Help Command.....	151
Rotation .....	302	Transmission .....	87	Join Calls .....	157
Safety.....	285, 293	Automatic.....	86, 87, 272	Making A Phone Or Audio Device	
Sizes.....	287	Fluid .....	314	A Favorite .....	154
Snow Tires.....	297	Maintenance .....	272	Making A Second Call While Current	
Spare Tires.....	234, 297, 298, 299	Manual.....	83	Call Is In Progress.....	157
Spinning.....	295	Shifting.....	86	Managing Your Favorites .....	155
Trailer Towing.....	114	Transporting Pets.....	226	Natural Speech.....	151
Tread Wear Indicators.....	295	Tread Wear Indicators .....	295	Operation.....	150
Wheel Nut Torque .....	307	Trunk Lid (Deck Lid).....	59	Overview .....	149
To Open Hood.....	58	Trunk Release Remote Control .....	59	Pair (Link) Uconnect Phone To A	
Tongue Weight/Trailer Weight .....	113	Turn Signals.....	44, 75	Mobile Phone .....	151

Pair A Bluetooth Streaming			
Audio Device .....	153		
Phonebook Download .....	154		
Place/Retrieve A Call From Hold .....	157		
Power-Up .....	160		
Recent Calls .....	156		
Redial .....	157		
To Remove A Favorite .....	155		
Toggling Between Calls .....	157		
Touch-Tone Number Entry .....	156		
Transfer Call To And From			
Mobile Phone .....	158		
Voice Command .....	158		
Uconnect Settings			
Customer Programmable Features .....	19		
Uconnect System .....	134		
Uconnect Voice Command .....	26		
Uniform Tire Quality Grades .....	302		
Unleaded Gasoline .....	308		
Untwisting Procedure, Seat Belt .....	199		
		<b>V</b>	
		Vanity Mirrors .....	37
		Vehicle Certification Label .....	109
		Vehicle Identification Number (VIN) .....	307
		Vehicle Loading .....	109, 110, 290
		Vehicle Modifications/Alterations .....	9
		Vehicle Security Alarm .....	20
		Vehicle Storage .....	52, 303
		Voice Command .....	161, 164
		Voice Recognition System (VR) .....	26
		<b>W</b>	
		Warning Lights	
		Blue .....	76
		Green .....	75
		Red .....	69
		White .....	76
		Yellow .....	72
		Warning Lights	
		(Instrument Cluster Descriptions) .....	73
		Warning Lights And Messages .....	69
		Warranty Information .....	317
		Washer	
		Adding Fluid .....	258
		Washers, Windshield .....	47, 258
		Washing Vehicle .....	304
		Water	
		Driving Through .....	117
		Wheel And Wheel Tire Care .....	299
		Wheel And Wheel Tire Trim .....	299
		Wind Buffeting .....	56
		Window Fogging .....	52
		Windows .....	56
		Power .....	56
		Windshield Defroster .....	227
		Windshield Washers .....	46, 47
		Fluid .....	258
		Windshield Wiper Blades .....	265
		Windshield Wipers .....	46
		Wipers Blade Replacement .....	265
		Wipers, Intermittent .....	47
		Wipers, Rain Sensitive .....	48

The driver's primary responsibility is the safe operation of the vehicle. Driving while distracted can result in loss of vehicle control, resulting in an accident and personal injury. FCA US LLC strongly recommends that the driver use extreme caution when using any device or feature that may take their attention off the road. Use of any electrical devices, such as cellular telephones, computers, portable radios, vehicle navigation or other devices, by the driver while the vehicle is moving is dangerous and could lead to a serious accident. Texting while driving is also dangerous and should never be done while the vehicle is moving. If you find yourself unable to devote your full attention to vehicle operation, pull off the road to a safe location and stop your vehicle. Some states or provinces prohibit the use of cellular telephones or texting while driving. It is always the driver's responsibility to comply with all local laws.

This Owner's Manual has been prepared to help you get acquainted with your new Dodge brand vehicle and to provide a convenient reference source for common questions.

Not all features shown in this manual may apply to your vehicle. For additional information, visit [www.mopar.com](http://www.mopar.com) (U.S.), [www.mopar.ca](http://www.mopar.ca) (Canada) or your local Dodge brand dealer.

## **DRIVING AND ALCOHOL**

---

Drunk driving is one of the most frequent causes of accidents. Your driving ability can be seriously impaired with blood alcohol levels far below the legal minimum. If you are drinking, don't drive. Ride with a designated non-drinking driver, call a cab, a friend or use public transportation.

## **WARNING!**

---

Driving after drinking can lead to an accident. Your perceptions are less sharp, your reflexes are slower and your judgment is impaired when you have been drinking. Never drink and then drive.





Whether it's providing information about specific product features, taking a tour through your vehicle's heritage, knowing what steps to take following an accident or scheduling your next appointment, we know you'll find the app an important extension of your Dodge brand vehicle.

Simply download the app, select your make and model and enjoy the ride. To get this app, go directly to the App Store® or Google Play® Store and enter the search keyword "Dodge" (U.S. residents only).

**U. S.**



[mopar.com/om](http://mopar.com/om)

**DOWNLOAD A FREE ELECTRONIC COPY OF THE MOST UP-TO-DATE  
OWNER'S MANUAL, UCONNECT AND WARRANTY BOOKLETS**

**Canada**



[owners.mopar.ca](http://owners.mopar.ca)

©2022 FCA US LLC. ALL RIGHTS RESERVED. TOUS DROITS RÉSERVÉS.

DODGE IS A REGISTERED TRADEMARK OF FCA US LLC OR FCA CANADA INC., USED UNDER LICENSE. DODGE EST UNE MARQUE DÉPOSÉE DE FCA US LLC OU FCA CANADA INC., UTILISÉE SOUS LE PERMIS. APP STORE IS A REGISTERED TRADEMARK OF APPLE INC. GOOGLE PLAY STORE IS A REGISTERED TRADEMARK OF GOOGLE.

SECOND EDITION V1  
21\_LA\_OM\_EN\_USC