

CORSA

Owner's Manual



Contents

Introduction	2
In brief	6
Keys, doors and windows	9
Seats, restraints	27
Storage	47
Instruments and controls	54
Lighting	80
Climate control	89
Driving and operating	98
Vehicle care	161
Service and maintenance	198
Technical data	203
Customer information	212
Index	222

Introduction

Fuel	Designation	<input type="text"/>		
Engine oil	Grade	<input type="text"/>		
	Viscosity	<input type="text"/>		
Tyre pressure	Tyre size		Front	Rear
	Summer tyres	<input type="text"/>	<input type="text"/>	<input type="text"/>
	Winter tyres	<input type="text"/>	<input type="text"/>	<input type="text"/>
Weights	Gross vehicle weight rating	<input type="text"/>		
	- Kerb weight, basic model	<input type="text"/>		
	= Loading	<input type="text"/>		

Vehicle specific data

Please enter your vehicle's data on the previous page to keep it easily accessible.

Please refer to the sections "Service and maintenance", "Technical data", the vehicle's identification plate and national registration documents.

Introduction

Your vehicle is a designed combination of advanced technology, safety, environmental friendliness and economy.

This Owner's Manual provides you with all the necessary information to enable you to drive your vehicle safely and efficiently.

Make sure your passengers are aware of the possible risk of accident and injury which may result from improper use of the vehicle.

You must always comply with the specific laws and regulations of the country that you are in. These laws may differ from the information in this Owner's Manual.

Disregarding the description given in this manual may affect your warranty.

When this Owner's Manual refers to a workshop visit, we recommend your Opel Service Partner.

All Opel Service Partners provide first-class service at reasonable prices. Experienced mechanics trained by Opel work according to specific Opel instructions.

The customer literature pack should always be kept ready to hand in the vehicle.

Using this manual

- This manual describes all options and features available for this model. **Certain descriptions, including those for display and menu functions, may not apply to your vehicle due to model variant, country specifications, special equipment or accessories.**
- The table of contents at the beginning of this manual and within each section shows where the information is located.

- The index will enable you to search for specific information.
- This Owner's Manual depicts left-hand drive vehicles. Operation is similar for right-hand drive vehicles.
- The Owner's Manual uses the engine identifier code. The corresponding sales designation and engineering code can be found in the section "Technical data".
- Directional data, e.g. left or right, or front or back, always relate to the direction of travel.
- Displays may not support your specific language.
- Display messages and interior labelling are written in **bold** letters.

Danger, Warnings and Cautions

⚠ Danger

Text marked **⚠ Danger** provides information on risk of fatal injury. Disregarding this information may endanger life.

⚠ Warning

Text marked **⚠ Warning** provides information on risk of accident or injury. Disregarding this information may lead to injury.

Caution

Text marked **Caution** provides information on possible damage to the vehicle. Disregarding this information may lead to vehicle damage.

Symbols

Page references are indicated with ⇨. ⇨ means "see page".

Page references and index entries refer to the indented headings given in the section table of content.

We wish you many hours of pleasurable driving.

Your Opel Team

In brief

Initial drive information

Instrument panel overview

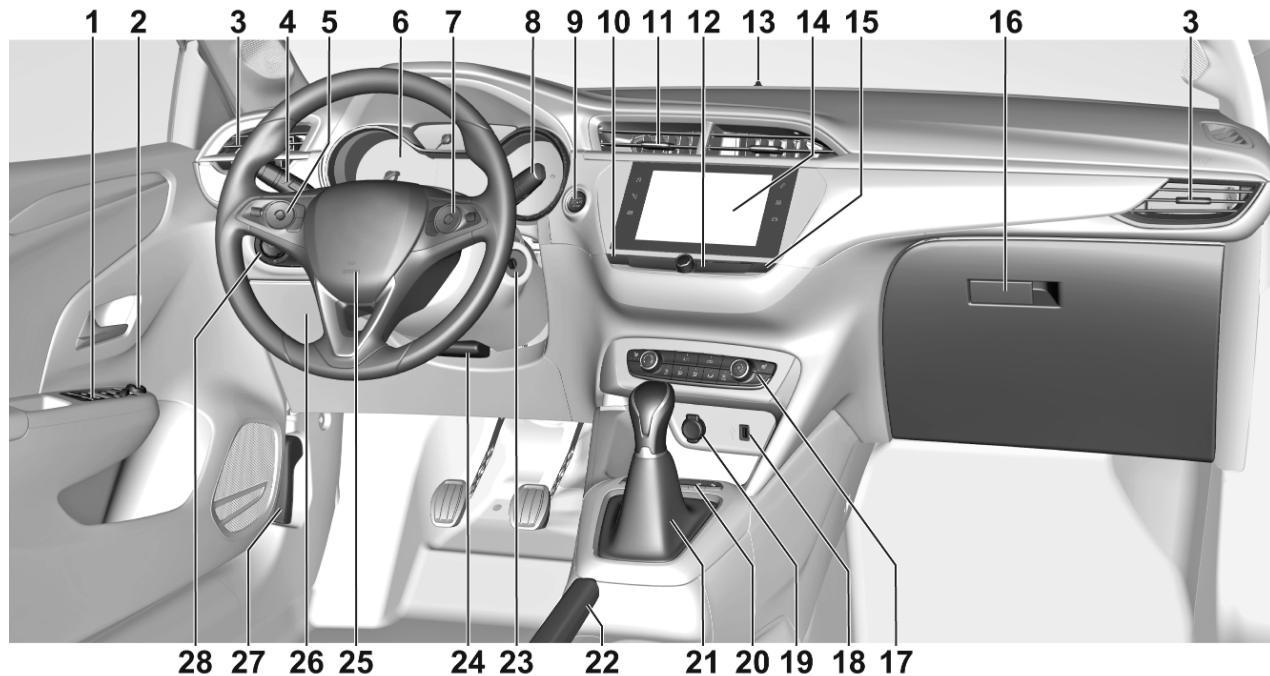

1	Power windows	23	13	Anti-theft alarm system status LED	19	28	Light switch	80
2	Exterior mirrors	21	14	Info Display	75		Headlight range adjustment	82
3	Side air vents	96	15	Hazard warning flashers	85		Front / rear fog lights	85
4	Turn lights, headlight flash, low / high beam	85	16	Glovebox	47		Instrument illumination	87
	Parking lights	86	17	Climate control system	90			
	Buttons for Driver Information Centre	73	18	USB charging port	59			
5	Cruise control	120	19	Power outlet	59			
	Adaptive cruise control	124	20	Parking assist / Advanced parking assist	138			
	Speed limiter	122		Lane keep assist	152			
	Heated steering wheel	55		Stop start system	103			
6	Instruments	63		Electronic Stability Control and Traction Control	118			
	Driver Information Centre	73	21	Manual transmission	114			
7	Infotainment controls			Automatic transmission	110			
8	Windscreen wiper and washer, rear wiper and washer	56	22	Manual parking brake	115			
9	Power button	100		Electric parking brake	115			
10	Central locking system	12	23	Ignition switch	99			
11	Centre air vents	96	24	Steering wheel adjustment ..	55			
12	Controls for Info Display operation	75	25	Horn	56			
			26	Fuse box	176			
			27	Bonnet release lever	163			

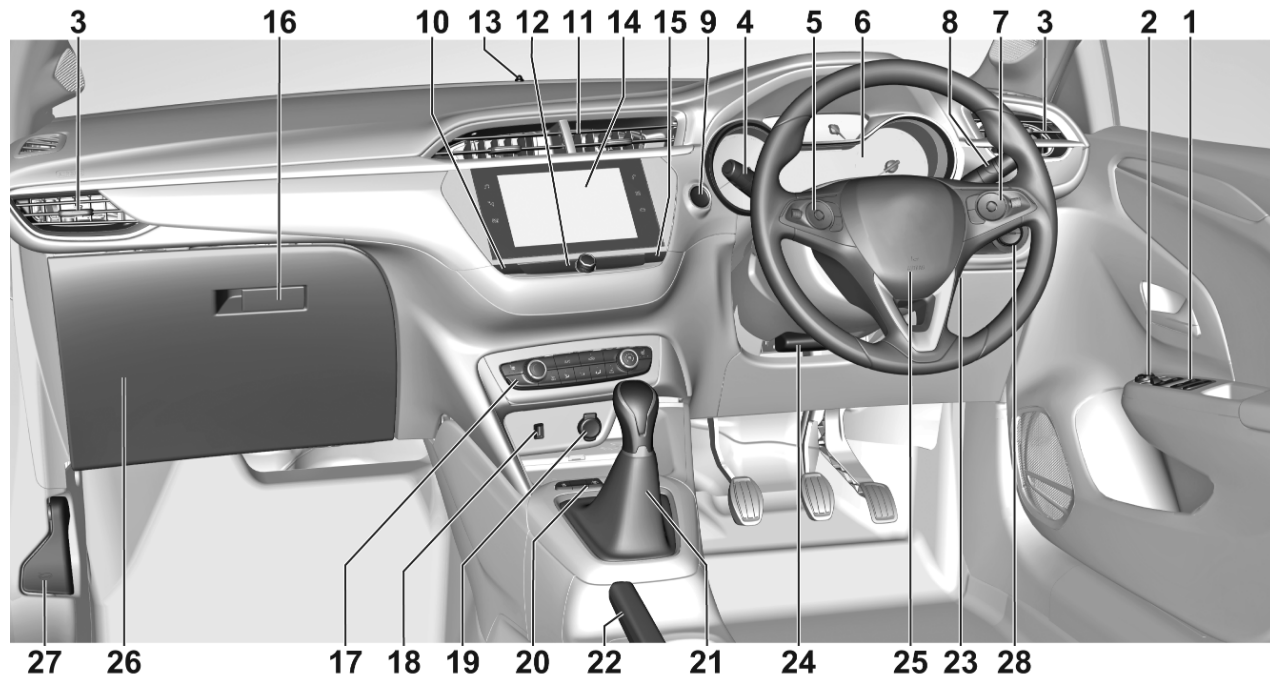

Keys, doors and windows

Keys, locks	9
Keys	9
Radio remote control	10
Electronic key system	11
Central locking system	12
Automatic locking	16
Child locks	17
Doors	18
Load compartment	18
Vehicle security	18
Anti-theft locking system	18
Anti-theft alarm system	19
Immobiliser	20
Exterior mirrors	21
Convex shape	21
Electric adjustment	21
Folding mirrors	21
Heated mirrors	22
Interior mirrors	22
Manual anti-dazzle	22
Automatic anti-dazzle	23
Windows	23
Windscreen	23

Power windows	23
Heated rear window	25
Sun visors	25
Roller blinds	26
Roof	26
Glass panel	26

Keys, locks

Keys

Caution
Do not attach heavy or bulky items to the ignition key.

Replacement keys

The key number is specified on a detachable tag.

The key number must be quoted when ordering replacement keys as it is a component of the immobiliser system.

Locks ⇨ 194.

Central locking ⇨ 12.

Starting the engine ⇨ 101.

Radio remote control ⇨ 10.

Electronic key ⇨ 11.

The code number of the adapter for the locking wheel nuts is specified on a card. It must be quoted when ordering a replacement adapter.

Wheel changing ⇨ 186.

Key with foldaway key section



Press button to extend. To fold the key, first press the button.

Radio remote control



Enables operation of the following functions via the use of the remote control buttons:

- central locking system ⇨ 12
- anti-theft locking system ⇨ 18
- anti-theft alarm system ⇨ 19
- tailgate unlocking and opening
- power windows ⇨ 23
- mirrors folding ⇨ 21
- vehicle locator lighting ⇨ 88
- peripheral lighting ⇨ 88

The remote control has a range of up to 100 m, but may also be much less due to external influences. The hazard warning flashers confirm operation.

Handle with care, protect from moisture and high temperatures and avoid unnecessary operation.

Replacing battery in radio remote control

Replace the battery as soon as the system no longer operates properly or the range is reduced.

In the event of a discharged battery,  illuminates in the instrument cluster and a warning message is displayed in the Driver Information Centre.

Driver Information Centre ⇨ 76.



Batteries do not belong in household waste. They must be disposed of at an appropriate recycling collection point.

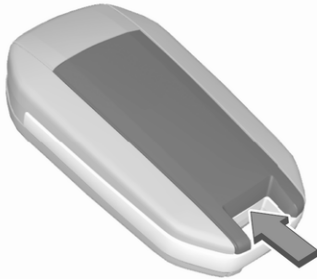

1. Remove the back cover from the remote control.
2. Extract the flat battery from its location.
3. Replace battery with a battery of the same type. Pay attention to the installation position.
4. Clip the back cover in place.

Fault

If the central locking system cannot be operated with the radio remote control, the cause may be one of the following:

- Fault in radio remote control.
- The battery voltage is too low.
- Overload of the central locking system by operating at frequent intervals, the power supply is interrupted for a short time.
- Interference from higher-power radio waves from other sources.

Manual unlocking ⇨ 12.

Electronic key system



Enables, depending on version, a keyless operation of the following functions:

- central locking system ⇨ 12
- ignition switching on and starting the engine ⇨ 101

The electronic key simply needs to be on the driver's person.

Additionally, the electronic key includes the functionality of the radio remote control ⇨ 10.

Handle with care, protect from moisture and high temperatures and avoid unnecessary operation.

Replacing battery in electronic key

Replace the battery as soon as the system no longer operates properly or the range is reduced.

In the event of a discharged battery,  illuminates in the instrument cluster and a warning message is displayed in the Driver Information Centre.

Driver Information Centre ⇨ 76.



Batteries do not belong in household waste. They must be disposed of at an appropriate recycling collection point.



1. Remove the cover.
2. Extract the flat battery from its location.
3. Replace battery with a battery of the same type. Pay attention to the installation position.
4. Clip the cover in place.

Fault

If the central locking cannot be operated or the engine cannot be started, the cause may be one of the following:

- Fault in electronic key.
- Electronic key is out of reception range.

- The battery voltage is too low.
- Overload of the central locking system by operating at frequent intervals, the power supply is interrupted for a short time.
- Interference from higher-power radio waves from other sources.

To rectify the cause of the fault, change the position of the electronic key.

Manual unlocking ⇨ 12.

Central locking system

Unlocks and locks doors, load compartment and fuel filler flap.

A pull on an interior door handle unlocks the respective door. Pulling the handle once more opens the door.

Note

In the event of an accident in which airbags or belt pretensioners are deployed, the vehicle is automatically unlocked.

Remote control operation

Unlocking





Press .

Note

A short time after unlocking with the remote control the doors are locked automatically if no door has been opened. A precondition is that the setting is activated in the vehicle personalisation \rightarrow 77.

Unlocking mode can be set in the vehicle personalisation menu in the Info Display. Two settings are selectable:

- All doors, load compartment and fuel filler flap will be unlocked by pressing  once.
- Only the driver's door and fuel filler flap will be unlocked by pressing  once. To unlock all doors, load compartment and fuel filler flap, press  twice.

Select the relevant setting in the Vehicle personalisation.

Vehicle personalisation \rightarrow 77.

Unlocking the tailgate

Press  to unlock the tailgate only.

Unlocking and opening the tailgate \rightarrow 18.

Locking

Close doors, load compartment and fuel filler flap.



Press .

If the vehicle is not closed properly, the central locking system will not work.

Confirmation

Operation of the central locking system is confirmed by the hazard warning flashers. A precondition is that the setting is activated in the vehicle personalisation \rightarrow 77.

Electronic key system operation

This system allows automatic vehicle locking and unlocking simply by detection of the electronic key. The electronic key must be outside the vehicle.

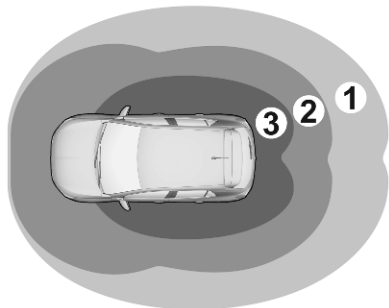

- Zone 1: switching on entry lighting
- Zone 2: automatic locking on leaving the vehicle
- Zone 3: automatic unlocking on approaching the vehicle

Note

A short time after automatic unlocking, the vehicle is relocked if no door has been opened.

If the ignition is switched off for more than nine days or the vehicle battery has no sufficient charging, the automatic function is disabled. Pass a hand behind the door handle of the driver's door to unlock the vehicle or press the tailgate button.

Unlocking

Unlocking mode can be set in the vehicle personalisation menu in the Info Display. Two settings are selectable:

- Only the driver's door and fuel filler flap will be unlocked.
- All doors, load compartment and fuel filler flap will be unlocked.

Vehicle personalisation ⇨ 77.

Operation with buttons on the electronic key



The central locking system can also be operated with the buttons on the electronic key.

Press  to lock.

Press  to lock.

Press  to unlock only the tailgate.

Remote control operation ⇨ 12.

Confirmation

Operation of central locking system is confirmed by the hazard warning flashers. A precondition is that the setting is activated in the vehicle personalisation ↻ 77.

Smart access

With that function a smart phone can be used as an electronic key. The vehicle is controlled via an application.

When approaching the vehicle confirm the message on the smart phone to open the vehicle.

Central locking button

Locks or unlocks all doors, the load compartment and fuel filler flap from inside the passenger compartment.



Press  to lock. The LED in the button illuminates.

Press  again to unlock. The LED in the button extinguishes.

Operation with the key in case of a central locking system fault

In case of a fault, e.g. vehicle battery or remote control / electronic key battery is discharged, the front door can be locked or unlocked with the mechanical key.

Manual unlocking



Electronic key: push the latch to extract the integral key.



Manually unlock the front door by inserting and turning the key in the lock cylinder.

The other doors can be opened by pulling the interior handle. The load compartment and fuel filler flap will possibly not be unlocked.

By switching on the ignition, the anti-theft locking system is deactivated.

Manual locking

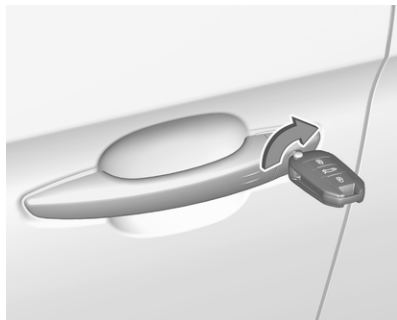

Manually lock the front door by inserting and turning the key in the lock cylinder.

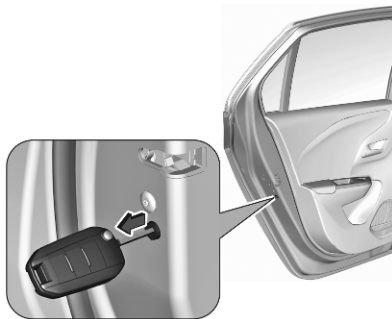

To lock the other doors, remove the black cover by using a key.

Insert key carefully and move it to the inner side of the door without turning the key.

Then, remove key and attach black cover again.

The fuel filler flap and tailgate are possibly not locked.

Automatic locking

Automatic locking after driving off

This system allows automatic locking of the doors and tailgate as soon as the speed of the vehicle exceeds a certain speed.

If one of the doors or the tailgate is open, the automatic central locking does not take place. This is signalled by the sound of the locks rebounding, accompanied by illumination of  in the instrument cluster, an audible signal and the display of an alert message.



This function can be activated or deactivated at any time. With the ignition on, press  until an audible signal starts and a corresponding message is displayed.

The state of the system stays in memory when switching off the ignition.

Automatic relock after unlocking

This feature automatically locks all doors, load compartment and fuel filler flap a short time after unlocking with the remote control or electronic key, provided no door has been opened.

Child locks

Warning

Use the child locks whenever children are occupying the rear seats.

Mechanical child locks

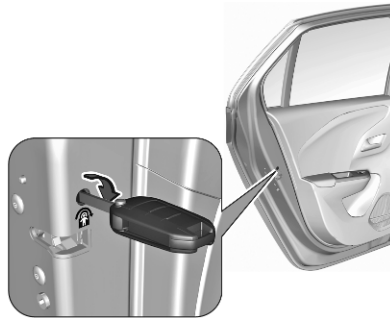

Turn the red child lock in the rear door inwards to the horizontal position by using a key. The door cannot be opened from the inside.

To deactivate, turn the child lock to the vertical position.

Electric child locks



Remotely operated system to prevent opening of the rear doors via the interior door handles and the use of the rear power windows.

Switching on

Press . The indicator lamp in the button comes on, accompanied by a confirmation message. This indicator lamp remains on until the child lock is switched off.

Switching off

Press  again. The indicator lamp on button goes off, accompanied by a confirmation message.

Doors

Load compartment

Tailgate

Opening

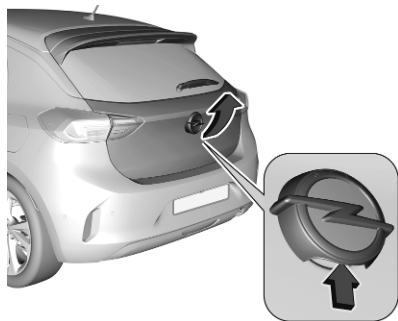

After unlocking, press the tailgate button below the brand emblem and open the tailgate.

Closing



Use the interior handle.

Do not push the touchpad whilst closing as this will unlock the tailgate again.

Central locking system ⇄ 12.

Vehicle security

Anti-theft locking system

⚠ Warning

Do not use the system if there are people in the vehicle! The doors cannot be unlocked from the inside.

The system deadlocks all the doors. All doors must be closed otherwise the system cannot be activated.

Unlocking the vehicle disables the mechanical anti-theft locking system. This is not possible with the central locking button.

Activating



Press  on the radio remote control twice within 5 seconds.

Anti-theft alarm system

The anti-theft alarm system is combined with the anti-theft locking system.

It monitors:

- doors, tailgate, bonnet
- passenger compartment including adjoining load compartment
- ignition

Activation

All doors, the load compartment and the engine compartment must be closed and the electronic key must not remain in the vehicle.

The system is self-activated 45 seconds after locking the vehicle.

If a door, the tailgate or the bonnet is not properly closed, the vehicle is not locked. However, the anti-theft alarm is self-activated after 45 seconds.



Note

Changes to the vehicle interior such as the use of seat covers and open windows, could impair the function of passenger compartment monitoring.

Activation without monitoring of passenger compartment



Switch off the monitoring of passenger compartment when animals are being left in the vehicle, because of high volume ultrasonic signals or movements triggering the alarm. Also, switch off when the vehicle is on a ferry or train.

1. Close tailgate, bonnet, windows.
2. Switch off ignition and press  within 10 seconds until the LED in the button  illuminates.

3. Leave the vehicle and close the doors.
4. Activate the anti-theft alarm system.

Indication

LED in the  button flashes if the anti-theft alarm system is activated. The hazard warning lights illuminate for a few seconds.

Deactivation

Unlocking the vehicle with radio remote control by pressing  or with the electronic key deactivates the anti-theft alarm system.

The system is not deactivated by unlocking the front door with the key or with the central locking button in the passenger compartment.

The hazard warning lights flash for a few seconds.

Alarm

When triggered, the alarm siren sounds and the hazard warning lights flash simultaneously. The number and duration of alarm signals are stipulated by legislation.

The anti-theft alarm can be deactivated by pressing  or switching on the ignition.

A triggered alarm, which has not been interrupted by the driver, will be indicated by the LED in the button . The LED will flash quickly the next time the vehicle is unlocked.

If the battery has been reconnected (e.g. after maintenance work), wait for 10 minutes to restart the engine.

Fault

If the LED in the button  illuminates permanently when switching on the ignition, seek the assistance of a workshop.

Locking the vehicle without activation of the anti-theft alarm

Lock the vehicle by locking the front door with the integral key.

Immobiliser

The system is part of the ignition switch and checks whether the vehicle is allowed to be started with the key being used.

The immobiliser is activated automatically.

Note

Radio Frequency Identification (RFID) tags may cause interference with the key. Do not have it placed near the key when starting the vehicle.

Note

The immobiliser does not lock the doors. Always lock the vehicle after leaving it  12.

Switch on the anti-theft alarm system  19.

Emergency operation of electronic key  100.

Exterior mirrors

Convex shape

The shape of the mirror makes objects appear smaller, which will affect the ability to estimate distances.

Side blind spot assistant ⇨ 21.

Electric adjustment

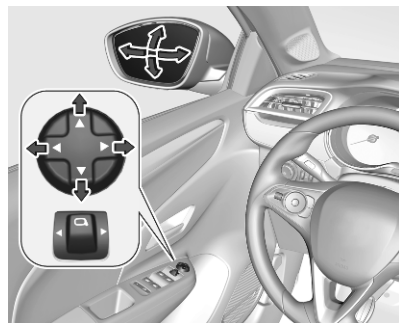

Select the relevant exterior mirror by pushing  to the left or right.

Then swivel the control to adjust the mirror.

Folding mirrors



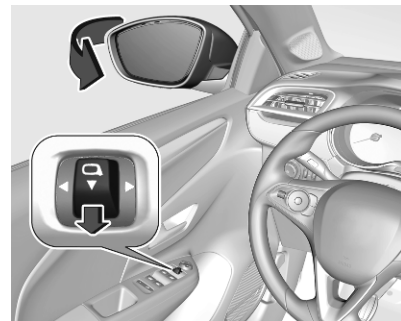

For pedestrian safety, the exterior mirrors will swing out of their normal mounting position if they are struck with sufficient force. Reposition the mirror by applying slight pressure to the mirror housing.

Electric folding



Move  to the centre position.

Pull  rearwards. Both exterior mirrors are folded.

Pull  rearwards again. Both exterior mirrors return to their original position.

If an electrically folded mirror is manually unfolded, pulling  rearwards will only unfold the other mirror electrically.

Heated mirrors



Operated by pressing  REAR.
Heating works with the engine running and is switched off automatically after a short time.
Heated rear window ↪ 25.

Interior mirrors

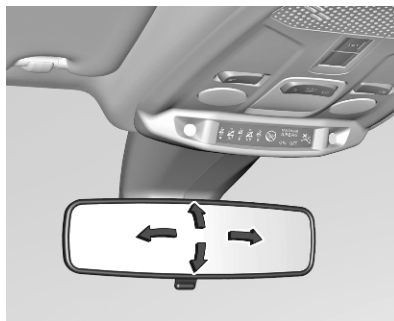

To adjust the mirror, move the mirror housing in the desired direction.

Manual anti-dazzle



To reduce dazzle, adjust the lever on the underside of the mirror housing.

Automatic anti-dazzle



Dazzle from following vehicles is automatically reduced, when driving in the dark.

Windows

Windscreen

Windscreen stickers

Do not attach stickers such as toll road stickers or similar on the windscreen in the area of the interior mirror. Otherwise the detection zone of the sensor and the view area of the camera in the mirror housing could be restricted.

Windscreen replacement

Caution

If the vehicle has a front-looking camera sensor for the driver assistance systems, it is very important that any windscreen replacement is performed accurately according to Opel specifications. Otherwise, these systems may not work properly and there is a risk of unexpected behaviour and / or messages from these systems.

Power windows

⚠ Warning

Take care when operating the power windows. Risk of injury, particularly to children.

If there are children on the rear seats, switch on the child safety system for the power windows.

Keep a close watch on the windows when closing them.

Ensure that nothing becomes trapped in them as they move.

Switch on ignition to operate power windows.

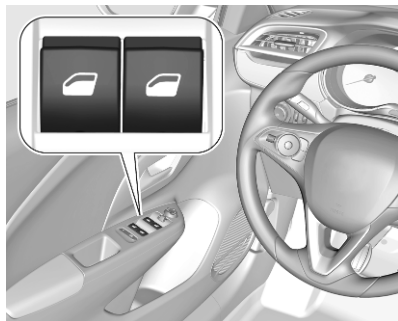

Operate the switch for the respective window by pushing to open or pulling to close.

Pushing or pulling gently to the first detent: window moves up or down as long as the switch is operated.



Pushing or pulling firmly to the second detent then releasing: window moves up or down automatically with safety function enabled. To stop movement, operate the switch once more in the same direction.

Safety function

If the window glass encounters resistance of the window during automatic closing, it is immediately stopped and opened again.

Child safety system for rear windows



Press  to deactivate rear door power windows; the LED illuminates. To activate, press  again.

Closing windows from outside

The windows can be closed remotely from outside the vehicle.

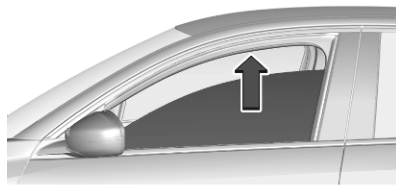

Press and hold  to close windows. Release button to stop window movement.

If the windows are fully closed, the hazard warning lights will flash twice.

Overload

If the windows are repeatedly operated within short intervals, the window operation is disabled for some time.

Initialising the power windows

If the windows cannot be closed automatically (e.g. after disconnecting the vehicle battery), a warning message is displayed in the Driver Information Centre.

Vehicle messages ⇨ 76.

Activate the window electronics as follows:

1. Close doors.
2. Switch on ignition.
3. Pull the switch until the window is completely opened and keep pulling for additional 2 seconds.
4. Push the switch as long as the window is completely closed and keep pushing for additional 2 seconds.
5. Repeat for each window.

Heated rear window

Operated by pressing  together with heated exterior mirrors.

Heating works with the engine running and is switched off automatically after a short time.

Depending on climate control system,  is located at a different position.

Vehicles with heating and ventilation system or air conditioning system



Vehicles with electronic climate control system



Heated mirrors ⇨ 22.

Sun visors

The sun visors can be folded down or swivelled to the side to prevent dazzling.

If the sun visors have integral mirrors, the mirror covers should be closed when driving.

A ticket holder is located on the backside of the sun visor.

Roller blinds

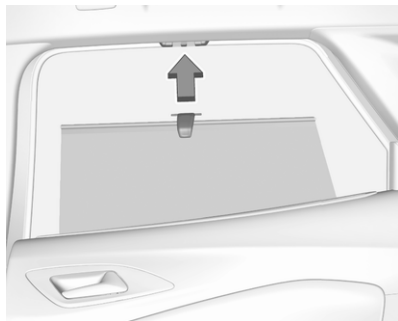

To reduce sunlight at the rear seats, pull the blind upwards using the grip and engage it at the top of the door frame.

Roof

Glass panel

Sunblind

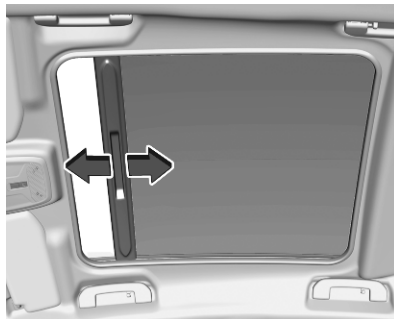

The sunblind is operated manually. Slide the sunblind to the desired position.

Seats, restraints

Head restraints	27
Front seats	28
Seat position	28
Manual seat adjustment	29
Power seat adjustment	30
Armrest	31
Heating	31
Massage	32
Seat belts	32
Three-point seat belt	33
Airbag system	34
Front airbag system	38
Side airbag system	38
Curtain airbag system	39
Airbag deactivation	39
Child restraints	41
Child restraint systems	41
Child restraint installation locations	44

Head restraints

Position

⚠ Warning

Only drive with the head restraint set to the proper position.

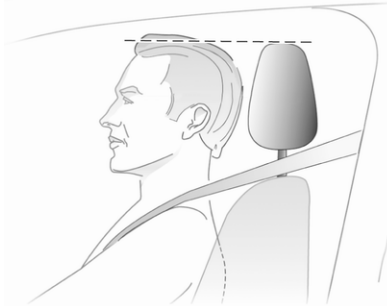

The upper edge of the head restraint should be at upper head level. If this is not possible for extremely tall people, set to highest position, and set to lowest position for small people.

Height adjustment

Head restraints on front seats

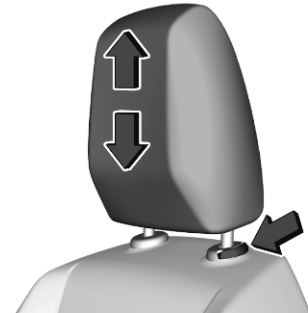

Pull the head restraint upwards or press the catch to release and push the head restraint downwards.

Head restraints on rear seats

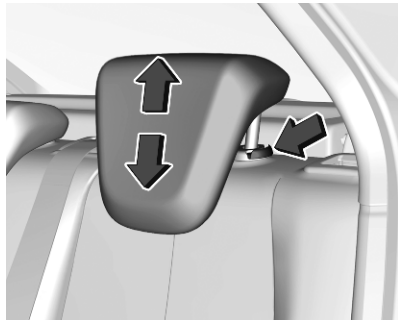

Pull the head restraint upwards or press the catch to release and push the head restraint downwards.

Removal

Press catch, pull the respective head restraint upwards and remove.

Front seats

Seat position

⚠ Warning

Only drive with the seat correctly adjusted.

⚠ Warning

Never adjust seats while driving as they could move uncontrollably.

⚠ Danger

Do not sit closer than 25 cm to the steering wheel, to permit safe airbag deployment.

⚠ Warning

Never store any objects under the seats.



- Sit with buttocks as far back against the backrest as possible. Adjust the distance between the seat and the pedals so that legs are slightly angled when pressing the pedals. Slide the front passenger seat as far back as possible.
- Set seat height high enough to have a clear field of vision on all sides and of all display instruments. There should be at least one hand of clearance between head and the roof frame. Your thighs should rest lightly on the seat without pressing into it.

- Sit with shoulders as far back against the backrest as possible. Set the backrest rake so that it is possible to easily reach the steering wheel with arms slightly bent. Maintain contact between shoulders and the backrest when turning the steering wheel. Do not angle the backrest too far back. We recommend a maximum rake of approx. 25°.
- Adjust seat and steering wheel in a way that the wrist rests on top of the steering wheel while the arm is fully extended and shoulders are on the backrest.
- Adjust the steering wheel ↻ 55.
- Adjust the head restraint ↻ 27.
- Adjust the lumbar support so that it supports the natural shape of the spine.

Manual seat adjustment

Drive only with engaged seats and backrests.

Longitudinal adjustment



Pull handle, slide seat, release handle. Try to move the seat back and forth to ensure that the seat is locked in place.

Backrest inclination



Turn handwheel. Do not lean on backrest when adjusting.

Seat height

Lever pumping motion

up : seat higher

down : seat lower

Power seat adjustment**⚠ Warning**

Care must be taken when operating the power seats. There is a risk of injury, particularly for children. Objects could become trapped.

Keep a close watch on the seats when adjusting them. Vehicle passengers should be informed accordingly.

Longitudinal adjustment

Move switch forwards / backwards.

Backrest inclination

Turn switch forwards / backwards.

Seat height and inclination

Move switch upwards / downwards.

Lumbar support



Press  or .

 : more lumbar support

 : less lumbar support

Armrest

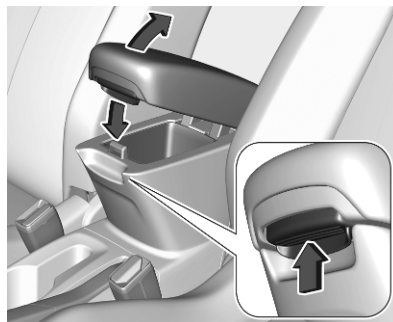

Push button and fold armrest upwards. Under the armrest there is a storage compartment.

Heating



Adjust heating to the desired setting by pressing  for the respective seat one or more times. The control indicator in the button indicates the setting.

Prolonged use of the highest setting for people with sensitive skin is not recommended.

Seat heating is operational when engine is running.

Stop-start system ⇨ 103.

Massage



Activate the back massage function by pressing . The LED in the button illuminates to indicate activation.

The massage function is activated for a period of 1 hour. During this time, massage is performed in six cycles with breaks in between.

Pressing once more deactivates massage function. The LED goes off.

The massage function is operational when engine is running and during an Autostop.

Stop-start system ⇨ 103.

Seat belts



The seat belts are locked during heavy acceleration or deceleration of the vehicle, holding the occupants in the seat position. Therefore the risk of injury is considerably reduced.

Warning

Fasten seat belt before each trip.

In the event of an accident, people not wearing seat belts endanger their fellow occupants and themselves.

Seat belts are designed to be used by only one person at a time.

Child restraint system ⇨ 41.

Periodically check all parts of the belt system for damage, soiling and proper functionality.

Have damaged components replaced. After an accident, have the seat belts and triggered belt pretensioners replaced by a workshop.

Note

Make sure that the belts are not damaged by shoes or sharp-edged objects or trapped. Prevent dirt from getting into the belt retractors.

Seat belt reminder

Each seat is equipped with a seat belt reminder, indicated by a control indicator for the respective seat in the roof console ⇨ 66.

Belt force limiters

Stress on the body is reduced by the gradual release of the belt during a collision.

Belt pretensioners

In the event of a head-on, rear-end or side-on collision of a certain severity, the front seat belts and the outer rear seat belts are tightened.

⚠ Warning

Incorrect handling (e.g. removal or fitting of belts) can trigger the belt pretensioners.

Deployment of the belt pretensioners is indicated by continuous illumination of control indicator  ↻ 67.

Triggered belt pretensioners must be replaced by a workshop. Belt pretensioners can only be triggered once.

Note

Do not affix or install accessories or other objects that may interfere with the operation of the belt pretensioners. Do not make any modifications to belt pretensioner components as this will invalidate the operating permit of your vehicle.

Three-point seat belt

Fasten

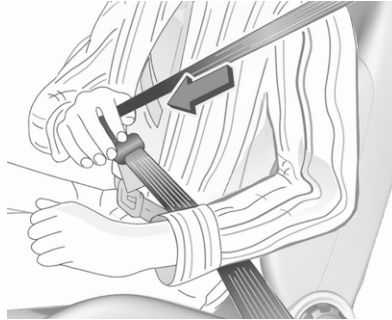

Withdraw the belt from the retractor, guide it untwisted across the body and insert the latch plate into the buckle. Tighten the lap belt regularly whilst driving by pulling the shoulder belt.

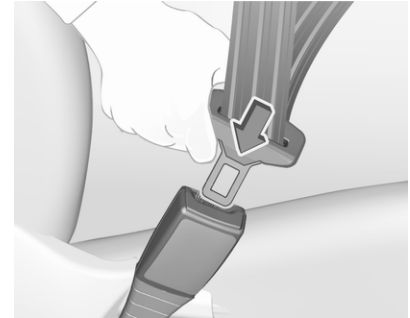

Loose or bulky clothing prevents the belt from fitting snugly. Do not place objects such as handbags or mobile phones between the belt and your body.

⚠ Warning

The belt must not rest against hard or fragile objects in the pockets of your clothing.

Seat belt reminder  ↻ 66.

Unfasten

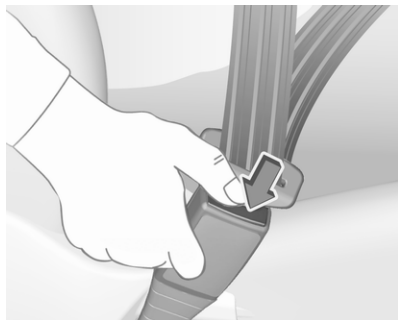

To release belt, press red button on belt buckle.

Using seat belts while pregnant



⚠ Warning

The lap belt must be positioned as low as possible across the pelvis to prevent pressure on the abdomen.

Airbag system

The airbag system consists of a number of individual systems depending on the scope of equipment.

When triggered, the airbags inflate within milliseconds. They also deflate so quickly that it is often unnoticeable during the collision.

⚠ Warning

The airbag system deploys in an explosive manner, repairs must be performed by skilled personnel only.

⚠ Warning

Adding accessories that change the vehicle's frame, bumper system, height, front end or side sheet metal, may keep the airbag system from working properly. The operation of the airbag system can also be affected by changing any parts of the front seats, seat belts,

airbag sensing and diagnostic module, steering wheel, instrument panel, inner door seals including the speakers, any of the airbag modules, ceiling or pillar trim, front sensors, side impact sensors or airbag wiring.

Note

The airbag systems and belt pretensioner control electronics are located in the centre console area. Do not put any magnetic objects in this area.

Do not affix any objects onto the airbag covers and do not cover them with other materials. Have damaged covers replaced by a workshop.

Each airbag is triggered only once. Have deployed airbags replaced by a workshop. Furthermore, it may be necessary to have the steering wheel, the instrument panel, parts of the panelling, the door seals, handles and the seats replaced.

Do not make any modifications to the airbag system as this will invalidate the vehicle operating permit.

Control indicator  for airbag systems
 ⇨ 67.

Child restraint systems on front passenger seat with airbag systems

Warning according to ECE R94.02:



EN: NEVER use a rearward-facing child restraint on a seat protected by an ACTIVE AIRBAG in front of it; DEATH or SERIOUS INJURY to the CHILD can occur.

DE: Nach hinten gerichtete Kindersitze NIEMALS auf einem Sitz verwenden, der durch einen davor befindlichen AKTIVEN AIRBAG

geschützt ist, da dies den TOD oder SCHWERE VERLETZUNGEN DES KINDES zur Folge haben kann.

FR: NE JAMAIS utiliser un siège d'enfant orienté vers l'arrière sur un siège protégé par un COUSSIN GONFLABLE ACTIF placé devant lui, sous peine d'infliger des BLESSURES GRAVES, voire MORTELLES à l'ENFANT.

ES: NUNCA utilice un sistema de retención infantil orientado hacia atrás en un asiento protegido por un AIRBAG FRONTAL ACTIVO. Peligro de MUERTE o LESIONES GRAVES para el NIÑO.

RU: ЗАПРЕЩАЕТСЯ устанавливать детское удерживающее устройство лицом назад на сиденье автомобиля, оборудованном фронтальной подушкой безопасности, если ПОДУШКА НЕ ОТКЛЮЧЕНА! Это может привести к СМЕРТИ или СЕРЬЕЗНЫМ ТРАВМАМ РЕБЕНКА.

NL: Gebruik NOOIT een achterwaarts gericht kinderzitje op een stoel met een ACTIEVE AIRBAG ervoor, om DODELIJK of ERNSTIG LETSEL van het KIND te voorkomen.

DA: Brug ALDRIG en bagudvendt autostol på et forsæde med AKTIV AIRBAG, BARNET kan komme i LIVSFARE eller komme ALVORLIGT TIL SKADE.

SV: Använd ALDRIG en bakåtvänd barnstol på ett säte som skyddas med en framförvarande AKTIV AIRBAG. DÖDSFALL eller ALLVARLIGA SKADOR kan drabba BARNET.

FI: ÄLÄ KOSKAAN sijoita taaksepäin suunnattua lasten turvaistuinta istuimelle, jonka edessä on AKTIIVINEN TURVATYYNY, LAPSI VOI KUOLLA tai VAMMAUTUA VAKAVASTI.

NO: Bakovervendt barnesikringsutstyr må ALDRI brukes på et sete med AKTIV KOLLISJONSPUTE foran, da det kan føre til at BARNET utsettes for LIVSFARE og fare for ALVORLIGE SKADER.

PT: NUNCA use um sistema de retenção para crianças voltado para trás num banco protegido com um AIRBAG ACTIVO na frente do mesmo, poderá ocorrer a PERDA DE VIDA ou FERIMENTOS GRAVES na CRIANÇA.

IT: Non usare mai un sistema di sicurezza per bambini rivolto all'indietro su un sedile protetto da AIRBAG ATTIVO di fronte ad esso: pericolo di MORTE o LESIONI GRAVI per il BAMBINO!

EL: ΠΟΤΕ μη χρησιμοποιείτε παιδικό κάθισμα ασφαλείας με φορά προς τα πίσω σε κάθισμα που προστατεύεται από μετωπικό ΕΝΕΡΓΟ ΑΕΡΟΣΑΚΟ, διότι το παιδί μπορεί να υποστεί ΘΑΝΑΣΙΜΟ ή ΣΟΒΑΡΟ ΤΡΑΥΜΑΤΙΣΜΟ.

PL: NIE WOLNO montować fotelika dziecięcego zwróconego tyłem do kierunku jazdy na fotelu, przed którym znajduje się WŁĄCZONA PODUSZKA POWIETRZNA. Niezastosowanie się do tego zalecenia może być przyczyną ŚMIERCII lub POWAŻNYCH OBRAŻEŃ u DZIECKA.

TR: Arkaya bakan bir çocuk emniyet sistemini KESİNLİKLE önünde bir AKTİF HAVA YASTIĞI ile korunmakta olan bir koltukta kullanmayınız. ÇOCUK ÖLEBİLİR veya AĞIR ŞEKİLDE YARALANABİLİR.

UK: НІКОЛІ не використовуйте систему безпеки для дітей, що встановлюється обличчям назад, на сидінні з УВІМКНЕНОЮ ПОДУШКОЮ БЕЗПЕКИ, інакше це може призвести до СМЕРТІ чи СЕРЬОЗНОГО ТРАВМУВАННЯ ДИТИНИ.

HU: SOHA ne használjon hátrafelé néző biztonsági gyerekülést előlről AKTÍV LÉGZSÁKKAL védett ülésen, mert a GYERMEK HALÁLÁT vagy KOMOLY SÉRÜLÉSÉT okozhatja.

HR: NIKADA nemojte koristiti sustav zadržavanja za djecu okrenut prema natrag na sjedalu s AKTIVNIM ZRAČNIM JASTUKOM ispred njega, to bi moglo dovesti do SMRTI ili OZBILJNJIH OZLJEDA za DIJETE.

SL: NIKOLI ne nameščajte otroškega varnostnega sedeža, obrnjenega v nasprotni smeri vožnje, na sedež z

AKTIVNO ČELNO ZRAČNO
BLAZINO, saj pri tem obstaja
nevarnost RESNIH ali SMRTNIH
POŠKODB za OTROKA.

SR: NIKADA ne koristiti bezbednosni
sistem za decu u kome su deca
okrenuta unazad na sedištu sa
AKTIVNIM VAZDUŠNIM
JASTUKOM ispred sedišta zato što
DETE može da NASTRADA ili da se
TEŠKO POVREDI.

МК: НИКОГАШ не користете детско
седиште свртено назад на
седиште заштитено со АКТИВНО
ВОЗДУШНО ПЕРНИЧЕ пред него,
затоа што детето може ДА ЗАГИНЕ
или да биде ТЕШКО ПОВРЕДЕНО.

BG: НИКОГА не използвайте
детска седалка, гледаща назад,
върху седалка, която е защитена
чрез АКТИВНА ВЪЗДУШНА
ВЪЗГЛАВНИЦА пред нея - може да
се стигне до СМЪРТ или
СЕРИОЗНО НАРАНЯВАНЕ на
ДЕТЕТО.

RO: Nu utilizați NICIODATĂ un scaun
pentru copil îndreptat spre partea din
spate a mașinii pe un scaun protejat
de un AIRBAG ACTIV în fața sa;

acest lucru poate duce la DECESUL
sau VĂTĂMAREA GRAVĂ a
COPILULUI.

CS: NIKDY nepoužívejte dětský
zádržný systém instalovaný proti
směru jízdy na sedadle, které je
chráněno před sedadlem AKTIVNÍM
AIRBAGEM. Mohlo by dojít k
VÁŽNĚMU PORANĚNÍ nebo ÚMRTÍ
DÍTĚTE.

SK: NIKDY nepoužívajte detskú
sedačku otočenú vzad na sedadle
chránenom AKTÍVNYM AIRBAGOM,
pretože môže dôjsť k SMRTI alebo
VÁŽNYM ZRANENIAM DIĎAŤA.

LT: JOKIU BŪDU nemontuokite atgal
atgręžtos vaiko tvirtinimo sistemas
sėdynėje, prieš kurią įrengta AKTYVI
ORO PAGALVĖ, nes VAIKAS GALI
ŽŪTI arba RIMTAI SUSIŽALOTI.

LV: NEKĀDĀ GADĪJUMĀ
neizmantojiet uz aizmuguri vērstu
bērnu sēdekļīti sēdvietā, kas tiek
aizsargāta ar tās priekšā uzstādītu
AKTĪVU DROŠĪBAS SPILVENU, jo
pretējā gadījumā BĒRNS var gūt
SMAGAS TRAUMAS vai IET BOJĀ.

ET: ÄRGE kasutage tahapoole
suunatud lapseturvaistet istmel, mille
ees on AKTIIVSE TURVAPADJAGA
kaitstud iste, sest see võib
põhjustada LAPSE SURMA või
TÕSISE VIGASTUSE.

MT: QATT tuża trażżin għat-tfal li
jgħares lejn in-naħa ta' wara fuq sit
protett b'AIRBAG ATTIV quddiemu;
dan jista' jikkawża l-MEWT jew
ĠRIEHI SERJI lit-TFAL.

GA: Ná húsáid srian sábháilteachta
linbh cúil RIAMH ar shuíochán a
bhfuil mála aeir ag feidhmiú os a
chomhair. Tá baol BÁIS nó GORTÚ
DONA don PHÁISTE ag baint leis.

Beyond the warning required by
ECE R94.02, for safety reasons a
forward-facing child restraint system
must only be used subject to the
instructions and restrictions in the
table ⇨ 44.

The airbag label is located on both
sides of the front passenger sun visor.

Airbag deactivation ⇨ 39.

Front airbag system

The front airbag system consists of one airbag in the steering wheel and one in the instrument panel on the front passenger side. These can be identified by the word **AIRBAG**.

The front airbag system is triggered in the event of a front-end impact of a certain severity. The ignition must be switched on.

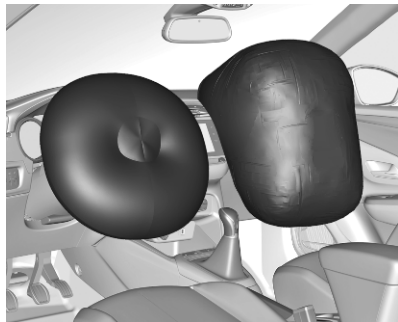

The inflated airbags cushion the impact, thereby reducing the risk of injury to the upper body and head of the front seat occupants considerably.

⚠ Warning

Optimum protection is only provided when the seat is in the proper position.

Seat position ⇨ 28.

Keep the area in which the airbag inflates clear of obstructions.

Fit the seat belt correctly and engage securely. Only then is the airbag able to protect.

Side airbag system



The side airbag system consists of an airbag in each front seat backrest.

This can be identified by the word **AIRBAG**

The side airbag system is triggered in the event of a side impact of a certain severity. The ignition must be switched on.



The inflated airbags cushion the impact, thereby reducing the risk of injury to the upper body and pelvis in the event of a side-on collision considerably.

⚠ Warning

Keep the area in which the airbag inflates clear of obstructions.

Note

Only use protective seat covers that have been approved for the vehicle. Be careful not to cover the airbags.

Curtain airbag system

The curtain airbag system consists of an airbag in the roof frame on each side. This can be identified by the word **AIRBAG** on the roof pillars.

The curtain airbag system is triggered in the event of a side-on impact of a certain severity. The ignition must be switched on.

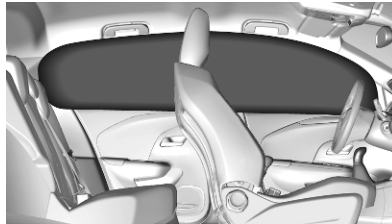

The inflated airbags cushion the impact, thereby reducing the risk of injury to the head in the event of a side-on impact considerably.

⚠ Warning

Keep the area in which the airbag inflates clear of obstructions.

The hooks on the handles in the roof frame are only suitable for hanging up light articles of clothing, without coat hangers. Do not keep any items in these clothes.



Airbag deactivation

The front passenger airbag system must be deactivated for child restraint system on the passenger seat according to the instructions in the table ↗ 44. The side airbag and curtain airbag systems, the belt pretensioners and all driver airbag systems will remain active.



The front passenger airbag system can be deactivated via a key-operated switch in the glovebox.

Use the ignition key to choose the position:

OFF  : front passenger airbag is deactivated and will not inflate in the event of a collision, control indicator OFF  illuminates continuously in the centre console.

ON  : front passenger airbag is active.

Danger

Deactivate passenger airbag only in combination with the use of a child restraint system, subject to the instructions and restrictions in the table ⇨ 44.

Otherwise, there is a risk of fatal injury for a person occupying a seat with a deactivated front passenger airbag.



If the control indicator  illuminates for approx. 60 seconds after the ignition is switched on, the front passenger airbag system will inflate in the event of a collision.

If the control indicator  illuminates after the ignition is switched on, the front passenger airbag system is deactivated. It stays on while the airbag is deactivated.

If both control indicators are illuminated at the same time, there is a system failure. The status of the system is not discernible, therefore no person is allowed to occupy the front passenger seat. Contact a workshop immediately.

Consult a workshop immediately if neither of the two control indicators are illuminated.

Change status only when the vehicle is stopped with the ignition off.

Status remains until the next change.

Control indicator for airbag deactivation ⇨ 67.

Child restraints

Child restraint systems

⚠ Danger

If using a rear-facing child restraint system on the front passenger seat, the airbag system for the front passenger seat must be deactivated. This also applies to certain forward-facing child restraint systems as indicated in the tables ⇨ 44.

Airbag deactivation ⇨ 39.

Airbag label ⇨ 34.

We recommend a child restraint system which is tailored specifically to the vehicle. For further information, contact your workshop.

Before fastening a child seat adjust the head restraint ⇨ 27.

When a child restraint system is being used, pay attention to the following usage and installation instructions and also those supplied with the child restraint system.

Always comply with local or national regulations. In some countries, the use of child restraint systems is forbidden on certain seats.

Child restraint systems can be fastened with:

- Three-point seat belt
- ISOFIX brackets
- Top-tether

Three-point seat belt

Child restraint systems can be fastened by using a three-point seat belt. After fastening the child restraint system the seat belt has to be tightened ⇨ 44.

ISOFIX brackets



Fasten vehicle-approved ISOFIX child restraint systems to the ISOFIX brackets. Specific vehicle ISOFIX child restraint system positions are marked in the ISOFIX table ⇨ 44.

ISOFIX brackets are indicated by a label on the backrest. To get access to the ISOFIX brackets, first pull the zipper.

An i-Size child restraint system is an universal ISOFIX child restraint system according UN Regulation No. 129.

All i-Size child restraint systems can be used on any vehicle seat suitable for i-Size, i-Size table ↗ 44.

Either a Top-tether strap or a support leg must be used in addition to the ISOFIX brackets.



i-Size child seats and vehicle seats with i-Size approval are marked with i-Size symbol, see illustration.

Top-tether anchors

Top-tether anchors are marked with the symbol  for a child seat.



In addition to the ISOFIX brackets, fasten the Top-tether strap to the Top-tether anchors.

ISOFIX child restraint systems of universal category positions are marked in the table by IUF ↗ 44.

Selecting the right system

The rear seats are the most convenient location to fasten a child restraint system.

Children should travel facing rearwards in the vehicle as long as possible. This makes sure that the

child's backbone, which is still very weak, is under less strain in the event of an accident.

Suitable are child restraint systems that comply with valid UN ECE regulations. Check local laws and regulations for mandatory use of child restraint systems.

The following child restraints are recommended for the following weight classes:

- **Group 0, Group 0+:** Maxi Cosi Cabriofix with or without ISOFIX base for children up to 13 kg
- **Group I:** Duo Plus with ISOFIX and Top-tether for children from 9 kg to 18 kg
- **Group II, Group III:** Kidfix XP with or without ISOFIX for children from 15 kg to 36 kg

Ensure that the child restraint system to be installed is compatible with the vehicle type.

Ensure that the mounting location of the child restraint system within the vehicle is correct, see following tables.

Allow children to enter and exit the vehicle only on the side facing away from the traffic.

When the child restraint system is not in use, secure the seat with a seat belt or remove it from the vehicle.

Note

Do not affix anything on the child restraint systems and do not cover them with any other materials.

A child restraint system which has been subjected to stress in an accident must be replaced.

Child restraint installation locations

Permissible options for fastening a child restraint system with a three-point seat belt

Weight class	On front passenger seat		On rear outer seats	On rear centre seat
	activated airbag	deactivated airbag		
Group 0: up to 10 kg	X	U/L ^{1,2}	U/L ³	U/L ³
Group 0+: up to 13 kg	X	U/L ^{1,2}	U/L ³	U/L ³
Group I: 9 to 18 kg	X	U/L ^{1,2}	U/L ^{3,4}	U/L ^{3,4}
Group II: 15 to 25 kg	U/L ^{1,2}	X	U/L ^{3,4}	U/L ^{3,4}
Group III: 22 to 36 kg	U/L ^{1,2}	X	U/L ^{3,4}	U/L ^{3,4}

U : universal suitability in conjunction with three-point seat belt

L : suitable for particular child restraint systems of the 'specific-vehicle', 'restricted' or 'semi-universal' categories. The child restraint system must be approved for the specific vehicle type (refer to the vehicle type list of the child restraint system)

X : no child restraint system permitted in this weight class

¹ : move seat forwards as far as necessary and adjust seat backrest inclination as far as necessary to a vertical position to ensure that the belt runs forwards from the upper anchorage point

² : move seat height adjustment upwards as far as necessary and adjust seat backrest inclination as far as necessary to a vertical position to ensure that the belt is tight on the buckle side

³ : move the respective front seat ahead of the child restraint system forwards as far as necessary

⁴ : adjust the respective headrest as necessary or remove if required

Permissible options for fitting an ISOFIX child restraint system with ISOFIX brackets

Weight class	Size class	Fixture	On front passenger seat		On rear outer seats	On rear centre seat
			activated airbag	deactivated airbag		
Group 0: up to 10 kg	G	ISO/L2	X	X	X	X
	F	ISO/L1	X	X	X	X
	E	ISO/R1	X	IL	IL ¹	X
Group 0+: up to 13 kg	E	ISO/R1	X	IL	IL ¹	X
	D	ISO/R2	X	IL	IL ¹	X
	C	ISO/R3	X	IL	IL ¹	X
Group I: 9 to 18 kg	D	ISO/R2	X	IL	IL ^{1,2}	X
	C	ISO/R3	X	IL	IL ^{1,2}	X
	B	ISO/F2	X	IL	IL, IUF ^{1,2}	X
	B1	ISO/F2X	X	IL	IL, IUF ^{1,2}	X
	A	ISO/F3	X	IL	IL, IUF ^{1,2}	X
Group II: 15 to 25 kg			IL	X	IL ^{1,2}	X
Group III: 22 to 36 kg			IL	X	IL ^{1,2}	X

- IL : suitable for particular ISOFIX restraint systems of the 'specific-vehicle', 'restricted' or 'semi-universal' categories.
The ISOFIX restraint system must be approved for the specific vehicle type (refer to the vehicle type list of the child restraint system)
- IUF : suitable for ISOFIX forward-facing child restraint systems of universal category approved for use in this weight class
- X : no ISOFIX child restraint system approved in this weight class
- ¹ : move the respective front seat ahead of the child restraint system forwards as far as necessary
- ² : adjust the respective headrest as necessary or remove if required

ISOFIX size class and seat device

- A – ISO/F3 : forward-facing child restraint system for children of maximum size in the weight class 9 to 18 kg
- B – ISO/F2 : forward-facing child restraint system for smaller children in the weight class 9 to 18 kg
- B1 – ISO/F2X : forward-facing child restraint system for smaller children in the weight class 9 to 18 kg
- C – ISO/R3 : rear-facing child restraint system for children of maximum size in the weight class up to 18 kg
- D – ISO/R2 : rear-facing child restraint system for smaller children in the weight class up to 18 kg
- E – ISO/R1 : rear-facing child restraint system for young children in the weight class up to 13 kg
- F – ISO/L1 : left lateral facing position child restraint system (carry-cot)
- G – ISO/L2 : right lateral facing position child restraint system (carry-cot)

Permissible options for fitting an i-Size child restraint system with ISOFIX brackets

On front passenger seat

activated airbag deactivated airbag On rear outer seats On rear centre seat

i-Size child restraint systems	X	i - U	i - U	X
---------------------------------------	---	-------	-------	---

- i - U : suitable for i-Size 'universal' forward and rearward facing child restraint systems
- X : seating position not suitable for i-Size 'universal' child restraint systems.

Storage

Storage compartments	47
Glovebox	47
Cupholders	47
Door panel storage	48
Centre console storage	48
Load compartment	49
Load compartment cover	50
Rear floor storage cover	51
Lashing eyes	51
Roof rack system	51
Roof rack	51
Loading information	52

Storage compartments

⚠ Warning

Do not store heavy or sharp objects in the storage compartments. Otherwise, the storage compartment lid could open and vehicle occupants could be injured by objects being thrown around in the event of hard braking, a sudden change in direction or an accident.

Glovebox

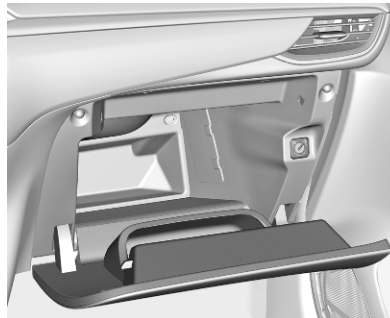

Pull lever to open the glovebox.

The glovebox should be closed whilst driving.

Cupholders

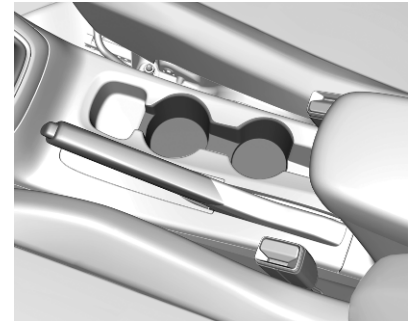

Cupholders are located in the centre console.

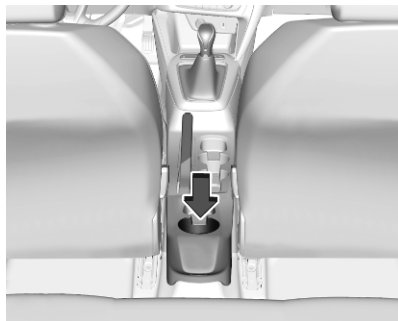

Depending on the version, additional cupholders may be located in the centre console.

Door panel storage

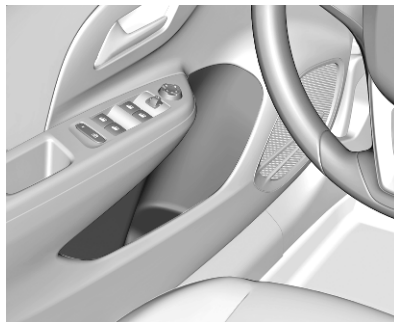

A storage compartment is located in the front and rear door panels.

Centre console storage

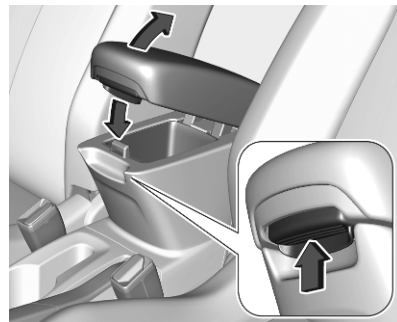

A storage compartment is located in the storage container.

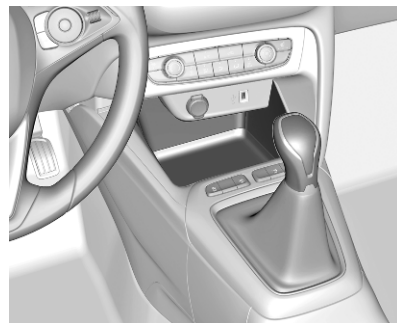

A storage compartment is located in the centre console.

Load compartment

The rear seat backrest is divided into 2/3 to 1/3 parts. Both parts can be folded down individually to increase the size of the load compartment.

Before folding rear seat backrests, execute the following if necessary:

- Move front seats forward if necessary.
- Remove the load compartment cover ↻ 50.
- Press and hold the catch to push the head restraints down ↻ 27.

Folding down/up rear backrests

- Check that the seat belts are not engaged in the seat belt buckles, so that the backrests can be moved.



- Pull the release lever on one or both outer sides and fold down the backrests onto the seat cushion.
- To fold up, raise the backrests and guide them into an upright position until they engage audibly. Make sure that the belts are positioned correctly and stay clear of the folding area.



The backrests are properly engaged when the red marks near the release levers are no longer visible.

⚠ Warning

When folding up, ensure that backrests are securely locked in position before driving. Failure to do so may result in personal injury or damage to the load or vehicle in the event of hard braking or a collision.



The seat belt of the centre seat could be blocked when the backrest is folded up too quickly. To unlock the retractor, push in the seat belt or pull it out by approx. 20 mm then release.

Load compartment cover

Do not place any objects on the cover.

Removing cover



Unhook retaining straps from tailgate.

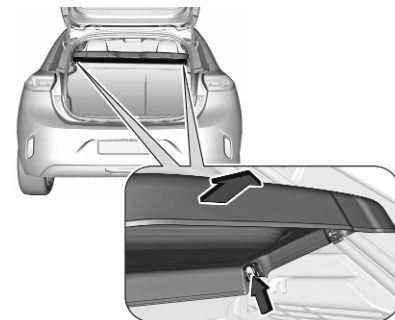

Lift cover at the front and push it upwards at the rear.

Remove the cover.

Fitting cover

Engage cover in side guides and fold downwards. Attach the retaining straps to the tailgate.

Rear floor storage cover

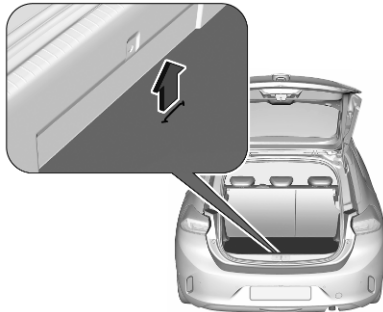

The rear floor cover can be lifted and removed. Use opening to raise the rear floor cover and then remove it.

Lashing eyes

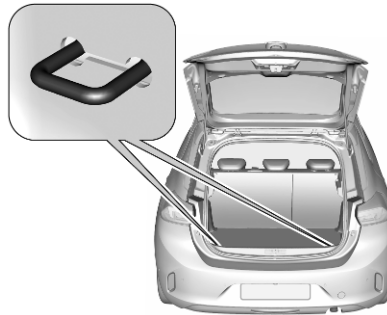

The lashing eyes are designed to secure items against slippage, e.g. using lashing straps or luggage net.

Roof rack system

Roof rack

For safety reasons and to avoid damage to the roof, the vehicle approved roof rack system is recommended. For further information, contact your workshop.



Open all doors.

Mounting points are located in each door frame of the vehicle body.

Fasten the roof rack according to the installation instructions delivered with the roof rack.

Remove the roof rack when not in use.

Loading information



- Heavy objects in the load compartment should be placed against the seat backrests. Make sure that the backrests are securely engaged. If objects can be stacked, heavier objects should be placed at the bottom.
- Prevent sliding of loose objects by securing them with straps attached to the lashing eyes ↪ 51.
- Do not allow the load to protrude above the upper edge of the backrests.

- Do not place any objects on the load compartment cover or the instrument panel, and do not cover the sensor on top of the instrument panel.
- The load must not obstruct the operation of the pedals, parking brake and gear selector, or hinder the freedom of movement of the driver. Do not place any unsecured objects in the interior.
- Do not drive with an open load compartment.

⚠ Warning

Always make sure that the load in the vehicle is securely stowed. Otherwise objects can be thrown around inside the vehicle and cause personal injury or damage to the load or car.

- The payload is the difference between the permitted gross vehicle weight (see identification plate ↪ 203) and the EC kerb weight.

To calculate the payload, enter the data for your vehicle in the weights table at the front of this manual.

The EC kerb weight includes weights for the driver (68 kg), luggage (7 kg) and all fluids (fuel tank 90% full).

Optional equipment and accessories increase the kerb weight.

- Driving with a roof load increases the sensitivity of the vehicle to cross-winds and has a detrimental effect on vehicle handling due to the vehicle's higher centre of gravity. Distribute the load evenly and secure it properly with retaining straps. Adjust the tyre pressure and vehicle speed according to the load conditions. Check and retighten the straps frequently.

Do not drive faster than 120 km/h.

The permissible roof load is 70 kg. Do not exceed a loading height of 40 cm. The roof load is

the combined weight of the roof rack and the load.

Instruments and controls

Controls	55
Steering wheel adjustment	55
Steering wheel controls	55
Heated steering wheel	55
Horn	56
Windscreen wiper and washer ..	56
Rear window wiper and washer	58
Outside temperature	58
Clock	59
Power outlets	59
Inductive charging	60
Cigarette lighter	61
Ashtrays	61
Warning lights, gauges and indicators	62
Instrument cluster	62
Speedometer	63
Odometer	63
Trip odometer	63
Tachometer	64
Fuel gauge	64
Engine coolant temperature gauge	64

Engine oil level monitor	65
Service display	65
Control indicators	66
Turn lights	66
Seat belt reminder	66
Airbag and belt tensioners	67
Airbag deactivation	67
Charging system	67
Malfunction indicator light	68
Service vehicle soon	68
Stop engine	68
System check	68
Brake and clutch system	68
Parking brake	69
Electric parking brake	69
Electric parking brake fault	69
Automatic operation of electric parking brake off	69
Antilock brake system (ABS)	69
Gear shifting	70
Lane keep assist	70
Electronic Stability Control and Traction Control system	70
Engine coolant temperature	70
Preheating	70
Exhaust filter	70
AdBlue	71
Deflation detection system	71
Engine oil pressure	71
Low fuel	72

Autostop	72
Exterior light	72
Low beam	72
High beam	72
High beam assist	72
LED headlights	72
Front fog lights	72
Rear fog light	72
Rain sensor	72
Active emergency braking	73
Door open	73
Displays	73
Driver Information Centre	73
Info Display	75
Vehicle messages	76
Warning chimes	77
Vehicle personalisation	77
Telematics services	78
Opel Connect	78

Controls

Steering wheel adjustment

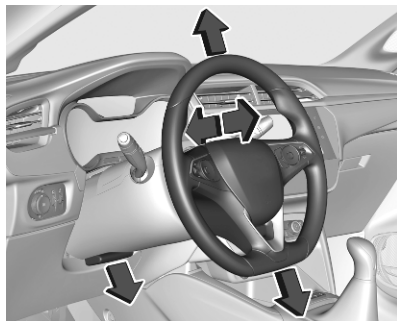

Unlock lever, adjust steering wheel, then engage lever and ensure it is fully locked.

Do not adjust steering wheel unless vehicle is stationary and steering wheel lock has been released.

Steering wheel controls

Some driver assistance systems, Infotainment system and a connected mobile phone can be operated via the controls on the steering wheel.



Further information is available in the Infotainment manual.

Driver assistance systems ⇨ 120.

Heated steering wheel



Activate heating by pressing . Activation is indicated by the LED in the button.



The recommended grip areas of the steering wheel are heated quicker and to a higher temperature than the other areas.

Heating is operational when the engine is running and during an Autostop.

Stop-start system ⇨ 103.

Horn

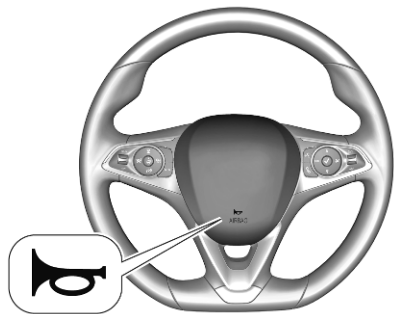

Press .

Windscreen wiper and washer

Windscreen wiper with adjustable wiper interval

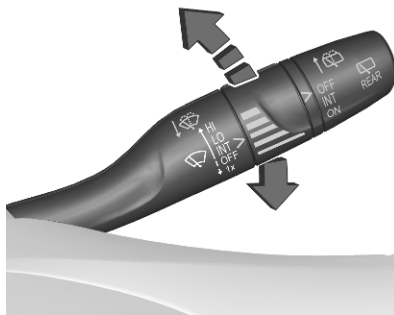

HI : fast
LO : slow
INT : interval wiping
OFF : off

For a single wipe when the windscreen wiper is off, press the lever down to position **1x**.

Do not use if the windscreen is frozen.

Switch off in car washes.

To activate interval wiping mode the next time ignition is switched on, press the lever downwards to position **OFF** and back to **INT**.

Adjustable wiper interval

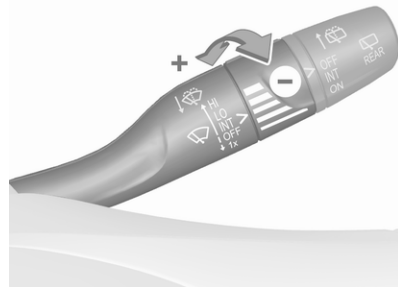

Wiper lever in position **INT**.

Turn the adjuster wheel to adjust the desired wipe interval.

Windscreen wiper with rain sensor

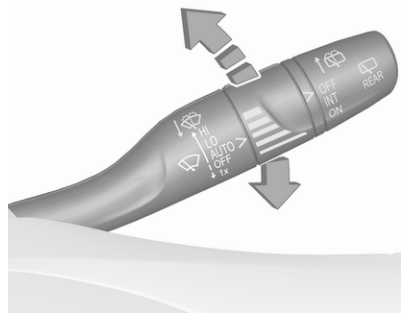

- HI** : fast
LO : slow
AUTO : automatic wiping with rain sensor
OFF : off

In **AUTO** position, the rain sensor detects the amount of water on the windscreen and automatically regulates the frequency of the windscreen wiper. If ignition is switched off for more than one minute, automatic wiping mode is deactivated. To activate automatic wiping mode the next time ignition is

switched on, press the lever downwards to position **OFF** and back to **AUTO**.

For a single wipe when the windscreen wiper is off, press the lever downwards to position **1x**.

Do not use if the windscreen is frozen.
 Switch off in car washes.

Adjustable sensitivity of the rain sensor

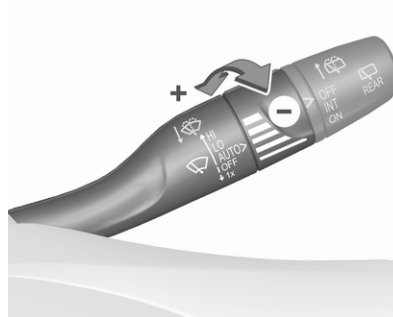

Turn the adjuster wheel to adjust the sensitivity.



Keep the sensor free from dust, dirt and ice.

Control indicator   56.

Windscreen washer

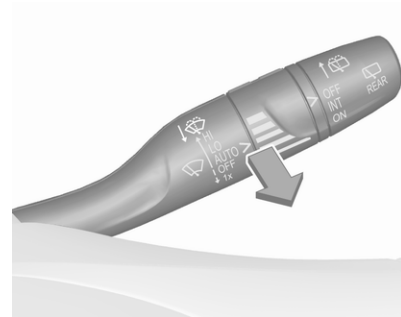

Pull lever. Washer fluid is sprayed onto the windscreen and the wiper wipes a few times.

Washer fluid ↪ 165.

Rear window wiper and washer

Rear window wiper



OFF : off
INT : intermittent operation
ON : continuous operation

Do not use if the rear window is frozen.

Switch off in car washes.

The rear window wiper comes on automatically when the windscreen wiper is switched on and reverse gear is engaged.

Activation or deactivation of this function can be changed in the Vehicle personalisation menu ↪ 77.

Rear window washer

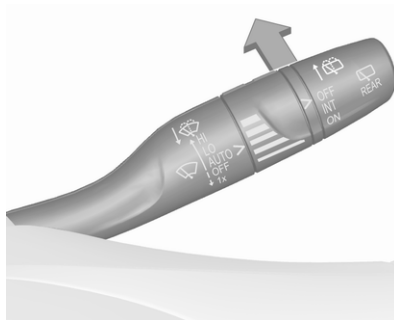

Push lever.

Washer fluid is sprayed onto the rear window and the wiper wipes a few times.

Washer fluid ↪ 165.

Outside temperature

A drop in temperature is indicated immediately and a rise in temperature after a time delay.

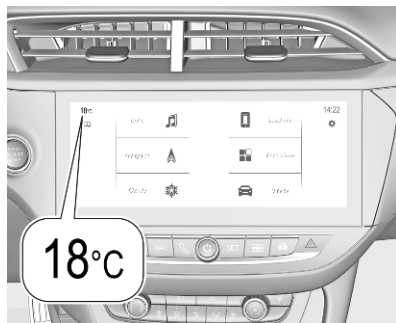

Illustration shows an example.

If outside temperature drops to a certain temperature, a warning message is displayed in the Driver Information Centre.

⚠ Warning

The road surface may already be icy even though the display indicates a few degrees above 0 °C.

Clock

Date and time are shown in the Info Display.

The adjustment of date and time is described in the Infotainment Manual.

Info Display ↗ 75.

Power outlets



A 12 V power outlet is located in the centre console.

Do not exceed the maximum power consumption of 120 W.

With ignition off, the power outlets are deactivated. Additionally the power outlets are deactivated in the event of low vehicle battery voltage.

Electrical accessories that are connected must comply with the electromagnetic compatibility requirements laid down in DIN VDE 40 839.

Do not connect any current-delivering accessories, e.g. electrical charging devices or batteries.

Do not damage the outlet by using unsuitable plugs.

Stop-start system ↗ 103.

USB ports



A USB port is located in the centre console.



Depending on version, an USB port may be located next to the Info Display.

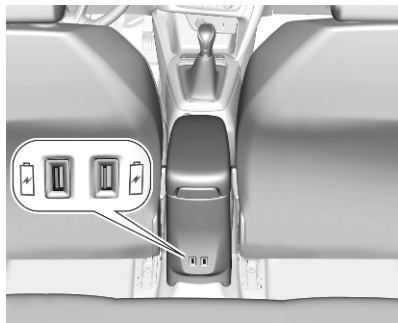

Further USB ports may be located in the rear console.

The slot below the USB ports on the rear side of the storage container is intended to attach an accessory cupholder.

The USB ports are prepared for charging external devices and provide a data connection to the Infotainment system. For further information, see Infotainment manual.

Note

The sockets must always be kept clean and dry.

Inductive charging

⚠ Warning

Inductive charging can affect the operation of implanted pacemakers or other medical devices. If applicable, seek medical advice before using the inductive charging device.

⚠ Warning

Remove any metal objects from the charging device before charging a mobile device, as these objects could become very hot.

To charge a device, the ignition must be switched on.

To charge a mobile device:

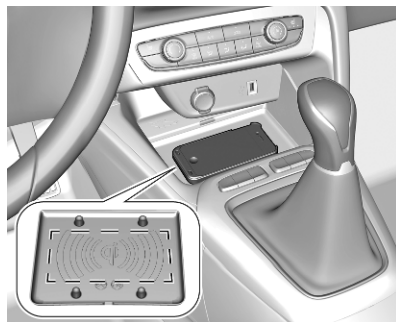

1. Remove all objects from the charging device.
2. Place the mobile device with the display facing upwards on the charging area. Note that the mobile device must not be placed on the positioning aids located above and below the charging area.

Qi compatible mobile devices can be charged inductively.

On some mobile devices, a back cover with an integrated coil or a jacket may be required to use inductive charging.

Protective cover for the mobile device could have impact on the inductive charging.

In the event that the mobile device is not charging properly, rotate it 180° and place it on the charging device again.

Status LED

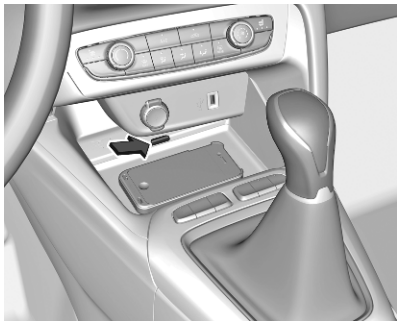

The LED indicates the current charging status.

Illuminates green

The mobile device is charging.

Flashes yellow

The mobile device has not been centred properly in the charging zone or an unknown object has been detected in the charging zone.

Illuminates yellow

There is a problem with the mobile device's battery or a fault of the inductive charger has been detected.

If the problem persists, seek the assistance of a workshop.

Cigarette lighter



Press in cigarette lighter. It switches off automatically once the element is glowing. Pull out cigarette lighter.

Ashtrays

Caution

To be used only for ash and not for combustible rubbish.

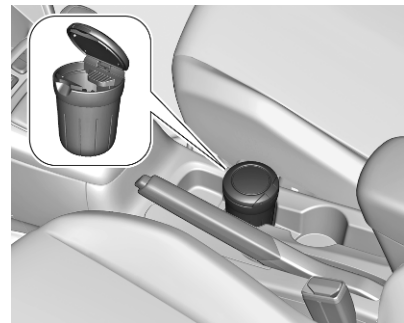

A portable ashtray can be placed in the cupholders.





Warning lights, gauges and indicators





























Instrument cluster

The following instrument cluster is available:



Overview

-  Turn lights ⇨ 66
-  Seat belt reminder ⇨ 66
-  Airbag and belt tensioners ⇨ 67
-  Airbag deactivation ⇨ 67

-  Charging system ⇨ 67
-  Malfunction indicator light ⇨ 68
-  Service vehicle soon ⇨ 68
-  Stop engine ⇨ 68
-  System check ⇨ 68
-  Brake and clutch system ⇨ 68
-  (P), Electric parking brake ⇨ 69
-  AUTO OFF Automatic operation of electric parking brake off ⇨ 69
-  (P)! Electric parking brake fault ⇨ 69
-  (ABS) Antilock brake system (ABS) ⇨ 69
-  ▲ Gear shifting ⇨ 70
-  Lane keep assist ⇨ 70
-  Electronic Stability Control and Traction Control system ⇨ 70
-  Engine coolant temperature high ⇨ 70
-  Preheating ⇨ 70
-  Exhaust filter ⇨ 70
-  AdBlue ⇨ 71
-  (!) Deflation detection system ⇨ 71
-  Engine oil pressure ⇨ 71
-  Low fuel ⇨ 72
-  (A) Autostop ⇨ 72
-  Exterior light ⇨ 72
-  Low beam ⇨ 72
-  High beam ⇨ 72
-  High beam assist ⇨ 72
-  Front fog lights ⇨ 72
-  Rear fog light ⇨ 72
-  AUTO Rain sensor ⇨ 72

 Active emergency braking
↔ 73

 Door open ↔ 73

Speedometer

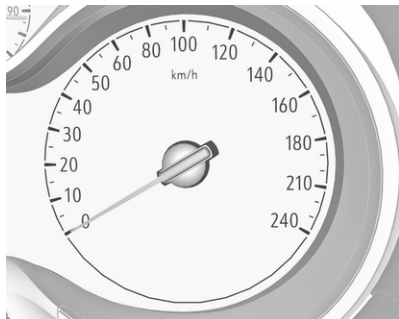

Indicates vehicle speed.

Odometer

The total recorded distance is displayed in km.

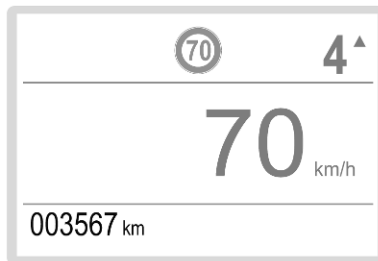

Trip odometer

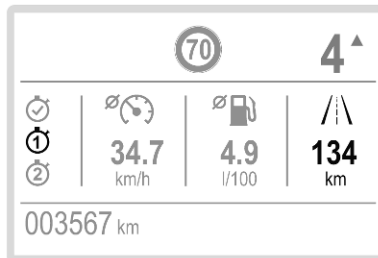

The recorded distance since the last reset is displayed in the Driver Information Centre.

Two trip odometer pages are selectable in the trip / fuel information menu for different trips.

Trip odometer counts up to 9,999 km.



Press **SET / CLR** for 2 seconds to reset the trip odometer.

Driver Information Centre ↔ 73.

Tachometer

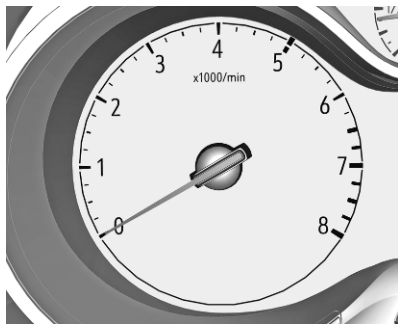

Displays the engine speed.

Drive in a low engine speed range for each gear as much as possible.

A red marker indicates the beginning of the warning zone of excessive revolutions. For Diesel engines, the warning zone starts at 5000 revolutions per minute. For petrol engines, the warning zone starts at 6500 revolutions per minute.

Caution

If the needle is in the red warning zone, the maximum permitted engine speed is exceeded. Engine at risk.

Fuel gauge



Control indicator ● illuminates if the fuel level is low.

Never run the fuel tank dry.

The top-up quantity may be less than the specified fuel tank capacity, due to the remaining fuel in the tank.

Engine coolant temperature gauge

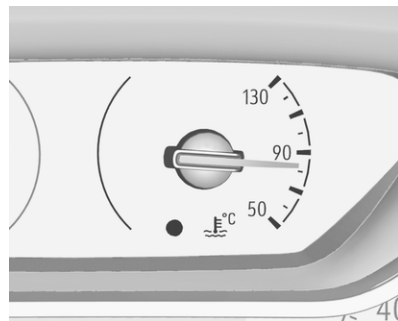

Displays the coolant temperature.

50 : engine operating temperature not yet reached
 90 : normal operating temperature
 130 : temperature too high

Control indicator ● illuminates if coolant temperature is too high. Switch off engine immediately.



Caution

If engine coolant temperature is too high, stop vehicle, switch off engine. Danger to engine. Check coolant level.

Engine oil level monitor

The state of the engine oil level is displayed in the Driver Information Centre for a few seconds following the service information after switching on the ignition.

A proper state of engine oil level is indicated by a message.

If oil level is low,  flashes and a message is indicated, accompanied by the  indicator. Confirm engine oil level by using the dipstick and top up engine oil respectively.

Engine oil ⇨ 164.

A fault of measurement is indicated by a message. Check engine oil level manually by using the dipstick.

Service display

The service system informs when to change the engine oil and filter or a vehicle service is required. Based on driving conditions, the interval at which an engine oil and filter change is required can vary considerably.

Service information ⇨ 198.

A required service due is displayed in the Driver Information Centre for several seconds after switching on the ignition.

If no service is required for the next 3000 km or more, no service information appears in the display.

If service is required within the next 3000 km, the remaining distance to the next service due, the distance travelled since the last service due or the time period that remains to the next service due is indicated for several seconds. Simultaneously symbol  illuminates temporary as reminder.

If service is required in less than 1000 km, the remaining distance to the next service due, the distance travelled since the last service due or

the time period that remains to the next service due is indicated for several seconds. Simultaneously  illuminates permanently as reminder.

Overdue service is indicated by a message in the Driver Information Centre which indicates the overdue distance.  flashes and then illuminates permanently until service is executed.

Reset of service interval

After each service, the service indicator must be reset to ensure proper functionality. It is recommended to seek the assistance of a workshop.

If service is executed by yourself, operate as following:

- switch off ignition

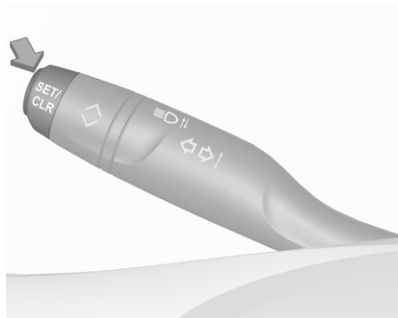

- press and hold **SET / CLR**
- switch on ignition, the distance indication begins a countdown
- when the display indicates =0, release **SET / CLR**

The symbol  disappears.

Retrieving service information

The status of the service information can be retrieved at any time via the Info Display. Press **Check** in the vehicle settings menu. The service information is displayed for a few seconds.

Info Display ⇨ 75.

Service information ⇨ 198.

Control indicators



The control indicators described are not present in all vehicles. The description applies to all instrument versions. Depending on the equipment, the position of the control indicators may vary. When the ignition is switched on, most control indicators will illuminate briefly as a functionality test.

The control indicator colours mean:

- red : danger, important reminder
- yellow : warning, information, fault
- green : confirmation of activation
- blue : confirmation of activation
- white : confirmation of activation

See all control indicators on different instrument clusters ⇨ 62.

Turn lights

  illuminates or flashes green.

Illuminates briefly

The parking lights are switched on.

Flashes

Turn lights or the hazard warning flashers are activated.

Rapid flashing: failure of a turn light or associated fuse, failure of turn light on trailer.

Bulb replacement ⇨ 169.



Turn lights ⇨ 85.

Seat belt reminder

Seat belt reminder on all seats

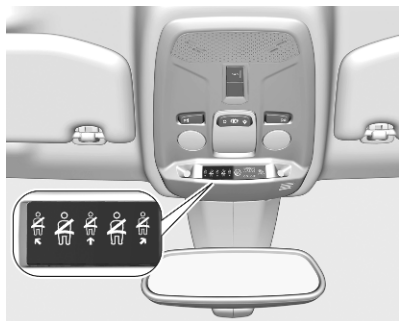
 illuminates or flashes red in the instrument cluster together with the indication in the roof console for each seat belt.



- When the ignition is switched on,  in the instrument cluster and the symbol for the respective seat in the roof console comes on, if the seat belt of any occupied seat has not been fastened.
- After driving off,  in the instrument cluster and the symbol for the respective seat in the roof console flashes for a certain time together with a chime. After a certain time of driving  illuminates constantly until the seat belt of the

respective seat has been fastened or if any passenger has unfastened the seat belt.

Seat belts ⇨ 32.

Airbag and belt tensioners

 illuminates red.

When the ignition is switched on, the control indicator illuminates for some seconds. If it does not illuminate, does not extinguish after some seconds or illuminates whilst driving, there is a fault in the airbag system. Seek the assistance of a workshop. The airbags and belt pretensioners may fail to trigger in the event of an accident.

Deployment of the belt pretensioners or airbags is indicated by continuous illumination of .

Warning

Have the cause of the fault remedied immediately by a workshop.

Belt pretensioners ⇨ 32.

Airbag system ⇨ 34.

Airbag deactivation



 **ON** illuminates yellow.

The front passenger airbag is activated.

 **OFF** illuminates yellow.

The front passenger airbag is deactivated.

Airbag deactivation ⇨ 39.

Charging system

 illuminates red.

Illuminates when the ignition is switched on and extinguishes shortly after the engine starts.

Illuminates when the engine is running

Stop, switch off engine. Vehicle battery is not charging. Engine cooling may be interrupted. The brake servo unit may cease to be effective. Seek the assistance of a workshop.

Malfunction indicator light

 illuminates or flashes yellow.

Illuminates when the ignition is switched on and extinguishes shortly after the engine starts.

Illuminates when the engine is running

Fault in the emission control system. The permitted emission limits may be exceeded. Seek the assistance of a workshop immediately.

Flashes when the engine is running

Fault that could lead to catalytic converter damage. Ease up on the accelerator until the flashing stops. Seek the assistance of a workshop immediately.

Service vehicle soon

 illuminates yellow.

Illuminates briefly when the ignition is switched on.

May illuminate together with other control indicators and a corresponding message in the Driver Information Centre.

Seek the assistance of a workshop immediately.

Stop engine

 illuminates red.

Illuminates briefly when the ignition is switched on.

Illuminates together with other control indicators, accompanied by a warning chime and a corresponding message in the Driver Information Centre.

Stop engine immediately and seek the assistance of a workshop.

System check

 illuminates yellow or red.

Illuminates yellow

A minor engine fault has been detected.

Illuminates red

A major engine fault has been detected.

Stop engine as soon as possible and seek the assistance of a workshop.

Brake and clutch system

 illuminates red.

The brake and clutch fluid level is too low.

⚠ Warning

Stop. Do not continue your journey. Consult a workshop.

Brake fluid ⇨ 166.

Parking brake

(P) illuminates red.

Illuminates when the parking brake is applied and ignition is switched on ⇨ 115.

Electric parking brake

(P) illuminates or flashes red.

Illuminates

Electric parking brake is applied ⇨ 115.

Flashes

Electric parking brake is not applied automatically. The application or the release are faulty.

⚠ Warning

Have the cause of the fault remedied immediately by a workshop.

Electric parking brake fault

(P)! illuminates yellow.

Illuminates

Electric parking brake has a fault ⇨ 115.

⚠ Warning

Have the cause of the fault remedied immediately by a workshop.

Automatic operation of electric parking brake off

 illuminates yellow.

Illuminates

Automatic operation is deactivated or faulty. In the event of a fault,  illuminates together with other control

indicators or it is accompanied by a corresponding message in the Driver Information Centre.

Activate automatic operation again or have the cause remedied by a workshop in the event of a fault.

Automatic operation ⇨ 115.

Antilock brake system (ABS)

(ABS) illuminates yellow.

Illuminates for a few seconds after the ignition is switched on. The system is ready for operation when the control indicator extinguishes.

If the control indicator does not extinguish after a few seconds, or if it illuminates while driving, there is a fault in the ABS. The brake system remains operational but without ABS regulation.

Antilock brake system ⇨ 115.

Gear shifting

▲ with the number of a higher gear is indicated, when upshifting is recommended for fuel saving reasons.

On vehicles with automatic transmission, the system is only active in manual mode.

Manual mode ⇨ 112.

Lane keep assist

 illuminates or flashes yellow.

Illuminates yellow

The system is deactivated or a fault has been detected.

Flashes yellow

The system is correcting the unintended lane change.

Lane keep assist ⇨ 152.



Electronic Stability Control and Traction Control system

 illuminates or flashes yellow.

Illuminates

A fault in the system is present. Continued driving is possible. Driving stability, however, may deteriorate depending on road surface conditions.

Have the cause of the fault remedied by a workshop.

After reconnecting the vehicle battery, (e.g. after maintenance work),  is illuminated for several seconds. After this time period,  extinguishes. This is a normal procedure, the vehicle does not need any assistance.

Flashes

The system is actively engaged. Engine output may be reduced and the vehicle may be braked automatically to a small degree.

Electronic Stability Control and Traction Control system ⇨ 118.

Engine coolant temperature

● illuminates red.

Illuminates when the engine is running

Stop, switch off engine.

Caution
Coolant temperature too high.

Check coolant level immediately
⇨ 165.

If there is sufficient coolant, consult a workshop.

Preheating

 illuminates yellow.

Preheating of diesel engine is activated. Only activates when outside temperature is low. Start the engine when control indicator extinguishes.

Starting the engine ⇨ 101.

Exhaust filter

 illuminates yellow.

The exhaust filter requires cleaning.

Continue driving until the control indicator extinguishes.

Illuminates temporarily

Start of saturation of the exhaust filter. Start cleaning process as soon as possible by driving at a vehicle speed of at least 60 km/h.

Illuminates constantly

Indication of a low additive level. Seek the assistance of a workshop.

Exhaust filter ↻ 106.

AdBlue

 flashes or illuminates yellow.

Illuminates yellow

The remaining driving range is between 800 km and 2400 km.

Flashes yellow

The remaining driving range is between 0 and 800 km.

AdBlue level is low. Refill AdBlue soon to avoid prevention of the engine start. Up to 13 l of AdBlue can be added.

AdBlue ↻ 107.

Deflation detection system

 illuminates or flashes yellow.

Illuminates

Tyre pressure loss in one or more wheels. Stop immediately and check tyre pressure.

Flashes

Fault in system. Consult a workshop. Deflation detection system ↻ 180.

Engine oil pressure

 illuminates red.

Illuminates when the ignition is switched on and extinguishes shortly after the engine starts.

Illuminates when the engine is running

Caution

Engine lubrication may be interrupted. This may result in damage to the engine and / or locking of the drive wheels.

1. Select neutral gear.
2. Move out of the flow of traffic as quickly as possible without impeding other vehicles.
3. Switch off ignition.

⚠ Warning

When the engine is off, considerably more force is needed to brake and steer. During an Autostop the brake servo unit will still be operational.

Do not remove key until vehicle is stationary, otherwise the steering wheel lock could engage unexpectedly.

Keep engine turned off and let the vehicle be towed to a workshop.

Low fuel

● illuminates yellow.

Level in fuel tank is too low.

Refuelling ⇨ 157.

Bleeding the diesel fuel system
⇨ 168.

Autostop

Ⓐ illuminates or flashes green.

Illuminates green

Engine is in an Autostop.

Flashes green

Autostop is temporarily unavailable, or Autostop mode is invoked automatically.

Stop-start system ⇨ 103.

Exterior light

⇨   illuminates green.

The exterior lights are on ⇨ 80.

Low beam

  illuminates green.

Illuminated when low beam is on.

High beam

  illuminates blue.

Illuminates when high beam is on, during headlight flash ⇨ 81.

High beam assist

  illuminates green.

The high beam assist is activated
⇨ 83.

LED headlights

 illuminates and a warning message is displayed in the Driver Information Centre.

Seek the assistance of a workshop.

Front fog lights

 illuminates green.

The front fog lights are on ⇨ 85.

Rear fog light

 illuminates yellow.

The rear fog light is on ⇨ 86.

Rain sensor

 AUTO illuminates green.

Illuminated when rain sensor position on wiper lever is selected.

Windscreen wiper and washer ⇨ 56.

Active emergency braking

 illuminates or flashes yellow.

Illuminates

The system has been deactivated or a fault has been detected.

Additionally, a warning message is displayed in the Driver Information Centre.

Check the reason of the deactivation ⇨ 132 and in case of a system fault, seek the assistance of a workshop.

Note

 also illuminates if the seat belts of the front passengers are not fastened. In this case, active emergency braking is deactivated.

Flashes

The system is actively engaged.

Depending on the situation, the vehicle may automatically brake moderately or hard.

Forward collision alert ⇨ 135.

Front pedestrian protection ⇨ 137.

Door open

 illuminates red.

A door or the tailgate is open.

Displays

Driver Information Centre

The Driver Information Centre is located in the instrument cluster.

Driver Information Centre indicates:

- overall and trip odometer
- digital speed indication
- trip / fuel information menu
- gear shift indication
- service information
- vehicle and warning messages
- driver assistance messages
- pop-up messages

Selecting menus and functions

The menus and functions can be selected via the buttons on the indicator lever.

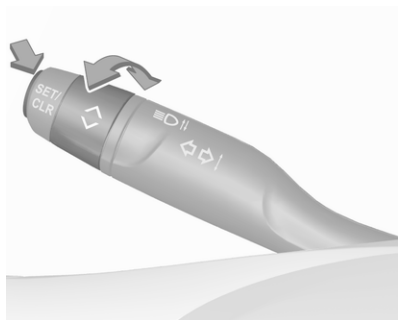

Turn the adjuster wheel to select a page in the trip / fuel information menu.

Press **SET / CLR** to confirm or reset a function.

Vehicle and service messages are popped up in the Driver Information Centre, if required. Scroll messages by turning the adjuster wheel. Confirm messages by pressing **SET / CLR**.

Vehicle messages ⇨ 76.

Trip / fuel information menu

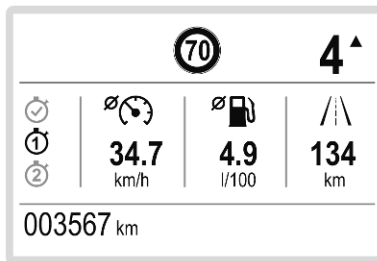

Different pages with combined information can be selected.

Turn the adjuster wheel to select a page.

Information page:

Fuel range

Range is calculated from current fuel level and current consumption. The display shows average values.

After refuelling, the range is updated automatically after a brief delay.

When the fuel level is low, a message appears on the display and the control indicator ● in the fuel gauge illuminates ⇨ 72.

Instantaneous Fuel Consumption

Display of the instantaneous consumption.

Trip 1 page:

Average speed

Display of average speed. The measurement can be reset at any time.

Average fuel consumption

Display of average consumption. The measurement can be reset at any time and starts with a default value.

Distance travelled

Displays the current distance for trip 1 since the reset.

The values of trip 1 page can be reset by pressing **SET / CLR** for a few seconds.

Trip 2 page:

Average speed

Display of average speed. The measurement can be reset at any time.

Average fuel consumption

Display of average consumption. The measurement can be reset at any time and starts with a default value.

Distance travelled

Displays the current distance for trip 2 since a certain reset.

The values of trip 2 page can be reset by pressing **SET / CLR** for a few seconds.

Digital speed page

Digital display of the instantaneous speed.

Autostop time counter

A time counter calculates the time spent in Autostop during a journey. It resets to zero every time the ignition is switched on.

Compass page

Displays the geographic direction of driving.

Blank page

No trip / fuel information is displayed.

Info Display

The Info Display is located in the instrument panel near the instrument cluster.

The Info Display can indicate:

- time ↻ 59
- outside temperature ↻ 58
- date ↻ 59
- Infotainment system, see description in the Infotainment Manual
- indication of rear view camera ↻ 150
- indication of panoramic view system ↻ 148
- navigation, see description in the Infotainment Manual
- vehicle and system messages ↻ 76
- settings for vehicle personalisation ↻ 77
- AdBlue range ↻ 107

Radio (Infotainment system)



Press  to switch on the display.

Touch  to select system settings (units, language, time and date).

Touch  to select vehicle settings or driving functions.

Confirm a required function or selection by touching.

Touch  on the display to return to the previous page.

Multimedia / Multimedia Navi / Multimedia Navi Pro



The illustrations show different variants of the infotainment system.



Selecting menus and settings

There are three options to operate the display:

- via buttons next to the display
- by touching the touchscreen with the finger
- via speech recognition

Button and touch operation



Press  to switch on the display.

Press  to select system settings (units, language, time and date).

Press  to select vehicle settings or driving functions.

Touch required menu display icon or a function with the finger.

Confirm a required function or selection by touching.

Touch  or  on the display to exit a menu without changing a setting.

For further information, see Infotainment Manual.

Speech recognition

Description see Infotainment Manual.

Vehicle personalisation  77.

Vehicle messages

Messages are indicated in the Driver Information Centre, in some cases together with a warning chime.

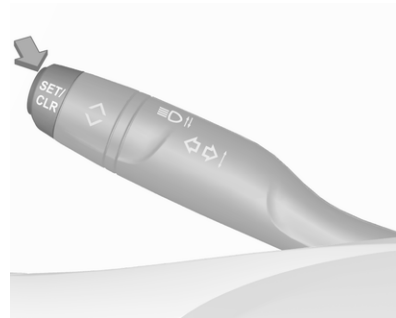

Press **SET / CLR** to confirm a message.

Vehicle and service messages

The vehicle messages are displayed as text. Follow the instructions given in the messages.

Messages in the Info Display

Some important messages may appear additionally in the Info Display. Some messages only pop-up for a few seconds.

Warning chimes

The warning chime regarding not fastened seat belts has priority over any other warning chime.

When starting the engine or whilst driving

A warning chime will sound when

- a seat belt is not fastened
- a door or the tailgate is not fully closed
- a certain speed is exceeded with parking brake applied
- cruise control deactivates automatically
- a programmed speed or speed limit is exceeded
- a warning message appears in the Driver Information Centre

- the electronic key is not in the passenger compartment
- the parking assist detects an object
- an unintended lane change occurs
- hands-off driving is recognised
- the exhaust filter has reached the maximum filling level

If several warnings appear at the same time, only one warning chime will sound

When the vehicle is parked and / or the driver's door is opened

- With exterior lights on.

During an Autostop

- If the driver's door is opened.
- If any condition for a restart of the engine is not fulfilled.

Vehicle personalisation

The vehicle's behaviour can be personalised by changing the settings in the Info Display.

Depending on vehicle equipment and country-specific regulations, some of the functions described below may not be available.

Some functions are only displayed or active when the engine is running.

Radio (Infotainment system)



Touch  to display the vehicle personalisation menu.

Parking, lighting, comfort and safety settings are adjustable.

Multimedia / Multimedia Navi / Multimedia Navi Pro



The illustrations show different variants of the infotainment system.



Touch  to display the vehicle personalisation menu.

Parking, lighting, comfort and safety settings are adjustable.

Telematics services

Opel Connect

Opel Connect comprises multiple connected services accessible via app, online or within the vehicle.

Note

Opel Connect is not available for all markets. For further information, contact your workshop.

Note

Full functionality of Opel Connect is subject to registration and proper activation.

Connected services may include live navigation such as online traffic information and vehicle status and information such as maintenance alerts.

Services accessible within the vehicle also include emergency call and breakdown call. These functions are automatically activated. Terms and conditions apply.

Emergency call function and breakdown call function are operated by the buttons in the overhead console.

Status LED in the overhead console

Illuminates green and red and extinguishes after a short time, when the ignition is switched on: the system works properly.

Illuminates red: fault in the system. Contact a workshop.

Flashes red: backup battery needs replacement. Contact a workshop.

Emergency call

The emergency call function will establish a connection to the nearest public safety answering point (PSAP). A minimum set of data including vehicle and location information will be sent to the PSAP.

Note

Establishing an emergency call may not be possible in areas without sufficient network availability or due to hardware damage during an accident.

In case of an emergency, press the red **SOS** button for more than 2 seconds. The LED flashes green to confirm that a connection to the nearest PSAP is being established. The LED illuminates steadily as long as the call is active.

Pressing the **SOS** button immediately a second time will terminate the call. The LED switches off.

Automatic crash notification

In case of an accident with airbag deployment, an automatic emergency call is established and an automatic crash notification will be transmitted to the next PSAP.

Breakdown call

Pressing the  button for more than 2 seconds connects you to a roadside assistance service provider.

For information about coverage and scope of services of the roadside assistance, please refer to the Service and warranty booklet.

Privacy settings

Privacy settings of Opel Connect can be configured in your vehicle. This will impact the set of data being sent, e.g., in case a breakdown call is triggered. The emergency call function will not be impacted.

Depending on version, the privacy settings can be changed by simultaneously pressing  and **SOS** in the overhead console or via the system settings menu in the Info Display.

Lighting

Exterior lighting	80
Light switch	80
Automatic light control	81
High beam	81
High beam assist	81
Headlight flash	82
Headlight range adjustment	82
Headlights when driving abroad	83
Daytime running lights	83
LED headlights	83
Hazard warning flashers	85
Turn lights	85
Front fog lights	85
Rear fog light	86
Parking lights	86
Reversing lights	86
Misted light covers	86
Interior lighting	87
Instrument panel illumination control	87
Interior lights	87
Reading lights	87
Sunvisor lights	87

Lighting features	88
Entry lighting	88
Exit lighting	88
Vehicle locator lighting	88
Peripheral lighting	88
Battery discharge protection	88

Exterior lighting

Light switch



Turn light switch:

AUTO : automatic light control
switches automatically
between daytime running
light and headlight

☞☞ : sidelights

☞☞☞ : headlights

When switching on the ignition,
automatic light control is active.

Control indicator ☞☞ ⇨ 72.

Tail lights

Tail lights are illuminated together with low / high beam and sidelights.

Automatic light control



When the automatic light control function is switched on and the engine is running, the system switches between daytime running lights and headlights automatically depending on the external lighting conditions and information given by the wiper system.

Daytime running light ⇨ 83.

Automatic headlight activation

During poor lighting conditions the headlights are switched on.

Additionally, headlights are switched on if the windscreen wipers have been activated for several wipes.

Tunnel detection

When a tunnel is entered, headlights are switched on immediately.

High beam



Push to switch from low to high beam.

Push again to deactivate high beam.

High beam assist ⇨ 83.

High beam assist

This feature activates the high beam when driving in dark surroundings and the vehicle speed is faster than 45 km/h.



The camera in the windscreen detects the lights of oncoming or preceding vehicles. Each LED on right or left side can be triggered or faded out particularly according to the traffic situation. The system switches from low beam to high beam and vice versa to prevent glaring. Once activated, high beam assist remains active and switches high beam on and off depending on surrounding conditions. The latest setting of the high beam assist will remain after the ignition is switched on again.

Activation

The system can be activated via the vehicle settings menu in the Info Display.

Info Display ⇨ 75.

High beam is switched on automatically at a speed above 45 km/h. High beam is switched off at a speed below 35 km/h, but high beam assist remains active.

The green control indicator  illuminates continuously when the high beam assist is activated, the blue  illuminates when high beam is on.

Control indicator  ⇨ 72,  ⇨ 72.

Pushing left indicator lever once switches on manual high beam without high beam assist.

High beam assist switches automatically to low beam when:

- Driving in urban areas.
- Camera detects heavy fog.
- Rear fog light is switched on.
- Oncoming vehicles are detected by the camera.

If there are no restrictions detected, the system switches back to high beam.

Deactivation

The system can be deactivated via the vehicle settings menu in the Info Display.

Info Display ⇨ 75.

Headlight flash

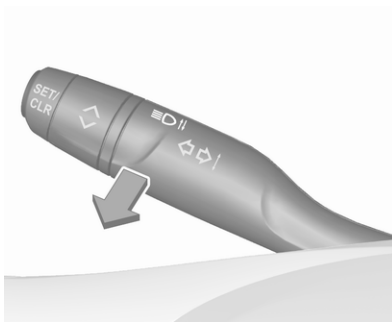

Pull to activate the headlight flash.

Headlight range adjustment



To adapt headlight range to the vehicle load to prevent dazzling, turn thumb wheel  to required position.

- 0 : front seats occupied
- 1 : all seats occupied
- 2 : all seats occupied and load compartment laden
- 3 : driver's seat occupied and load compartment laden

Headlights when driving abroad

When driving in countries where traffic drives on the opposite side of the road, the headlights do not have to be adjusted.

Daytime running lights

Daytime running lights increase visibility of the vehicle during daylight.

They are switched on automatically when the engine is running.

The system switches between daytime running lights and low beam automatically, depending on the lighting conditions.

Automatic light control ↷ 81.

LED headlights

The Matrix-LED headlight system contains a variety of particular LEDs in each headlight which enables the control of the adaptive forward lighting functions.

Light distribution and intensity of light are variably triggered depending on the lighting conditions, road type and driving situation. The vehicle adapts the headlights automatically to the situation to enable optimal light performance for the driver.

The adaptive forward lighting and the Matrix-LED headlights functions can be deactivated or activated in the vehicle personalisation menu.

Vehicle personalisation ↷ 77.

Info Display ↷ 75.

The glare-free high beam function of the Matrix-LED headlights are only available with light switch in position **AUTO**.

Country light

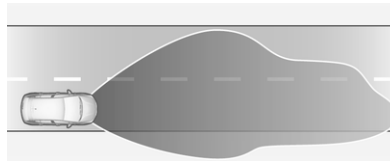

Activated automatically at a speed above 50 km/h when driving in rural areas. The illumination of the current

lane and the side of the road is adapted. Oncoming and preceding vehicles are not dazzled.

Town light

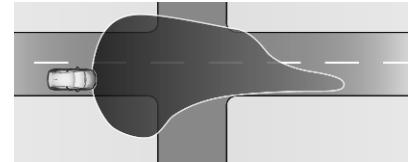

Activated automatically at a speed up to approx. 50 km/h. The light is wide and symmetrical.

Cornering light

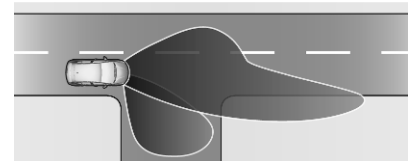

Activated at a speed of up to 40 km/h when turning off. The light consists of particular LEDs which illuminate the direction of travel. These LEDs are

triggered depending on the steering angle or the activation of the turn lights.

Curve light

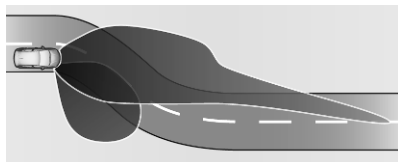

Particular LEDs, based on steering angle and speed, are additionally triggered to improve lighting in curves. This function is activated at speeds from 40 km/h to 70 km/h.

Glare-free high beam

⚠ Warning

The glare-free high beam function may dazzle other road users when the vehicle is driven in countries where traffic moves on the opposite side of the road. E.g. when the vehicle was designed for

left hand drive traffic and it is driven in a country with right hand drive traffic.

Switch off glare-free high beam function whenever you are driving in countries mentioned above!

The system enables a glare-free high beam when driving in dark surroundings.



Each LED on right or left side is triggered or faded out particularly according to the traffic situation. This gives the best light distribution without dazzling other road users.

Glare-free high beam is switched on automatically at a speed above 50 km/h. It is switched off at a speed below 35 km/h, but the system remains active.

Motorway mode





Activated automatically at a speed above 105 km/h. Illumination is adapted to the higher speed driven on motorways. If there is no oncoming traffic, the visibility on the side of the vehicle is increased. When following vehicles ahead or passing, dazzling for these vehicles is reduced.

Fault in LED headlight system

When the system detects a failure in the LED headlight system, it selects a preset position to avoid dazzling of oncoming traffic. A warning is displayed in the Driver Information Centre.

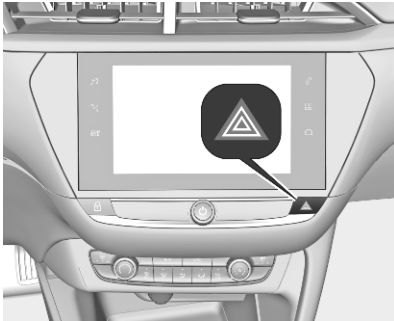
Hazard warning flashers



Operated by pressing .

When braking in an emergency, the hazard warning flashers are switched on automatically, depending on the force of deceleration. They are switched off automatically the first time you accelerate.

Turn lights

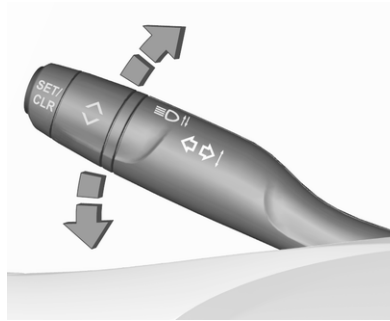

up : right turn lights
down : left turn lights

A resistance point can be felt when moving the indicator lever.

Constant flashing is activated when the indicator lever is being moved beyond the resistance point. It is deactivated when the steering wheel is moved in the opposite direction or indicator lever is manually moved back to its neutral position.

Activate temporary flashing by holding the indicator lever just before the resistance point. Turn lights will flash until indicator lever is being released.

To activate three flashes, tap the indicator lever briefly without passing the resistance point.

If you forget to cancel the turn lights for more than 20 seconds, the volume of the audible signal will increase if the speed is above 80 km/h.

Front fog lights



Operated by pressing .

Light switch in position **AUTO**: switching on front fog lights will switch headlights on automatically.

Rear fog light



Operated by pressing .

Light switch in position **AUTO**: switching on rear fog light will switch headlights on automatically.

Light switch in position : rear fog light can only be switched on with front fog lights.

The vehicle rear fog light is deactivated when towing a trailer or a plug is connected with the socket, e.g. when a bicycle carrier is used.

Parking lights

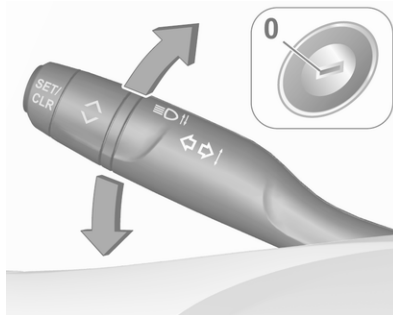

When the vehicle is parked, the parking lights on one side can be activated:

1. Switch off ignition.
2. Move the lever all the way up (right parking lights) or down (left parking lights).

Confirmed by a signal and the corresponding turn lights control indicator.

Reversing lights

The reversing light comes on when the ignition is on and reverse gear is selected.

Misted light covers

The inside of the light housing may mist up briefly in poor, wet and cold weather conditions, in heavy rain or after washing. The mist disappears quickly by itself. To help, switch on the headlights.

Interior lighting

Instrument panel illumination control



Brightness of the following lights can be adjusted when the exterior lights are on:

- instrument panel illumination
- Info Display
- illuminated switches and operation elements

Turn thumb wheel  and hold until the desired brightness is obtained.

Interior lights

During entry and exit of the vehicle, the front and rear courtesy lights automatically switch on and then off after a delay.

Note

In the event of an accident with airbag deployment the courtesy lights are turned on automatically.

Front courtesy light

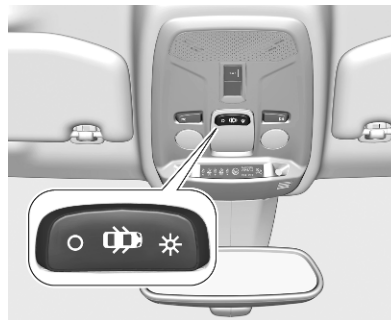

Operate rocker switch:

 : automatic switching on and off

press  : on

press  : off

Reading lights

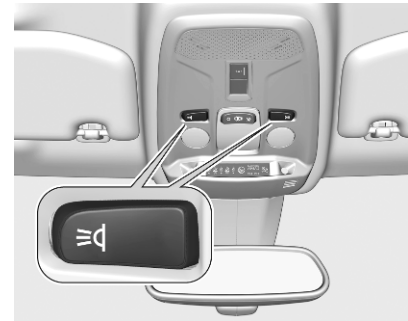

Operated by pressing .

Sunvisor lights

Illuminates when the cover is opened.

Lighting features

Entry lighting

Welcome lighting

Some or all of the following lights are switched on for a short time by unlocking the vehicle with the radio remote control:

- headlights
- puddle lights
- interior lights

The number of activated lights depends on the surrounding light conditions.

The lighting switches off immediately when the ignition is switched on.

Starting off ⇨ 99.

This function can be activated or deactivated in the vehicle personalisation.

Vehicle personalisation ⇨ 77.

The following lights will additionally switch on when the driver's door is opened:

- illumination of some switches
- Driver Information Centre
- door pocket lights

Exit lighting

The following lights are switched on when the ignition is switched off:

- headlights
- interior lights
- centre console lighting

They will switch off automatically after a delay. This function works only in the dark.

Vehicle locator lighting

This function allows to locate the vehicle, e.g., in weak lighting conditions using the remote control. The headlights come on and the turn lights flash for 10 seconds.

Press  on the remote control.

Peripheral lighting

Peripheral lighting allows you to switch on the position lights, low beam and number plate lighting using the remote control.

Press  on the remote control to switch on peripheral lighting.

Press  a second time to switch off peripheral lighting.

Battery discharge protection

To prevent discharge of the vehicle battery when the ignition is switched off, some interior lights are switched off automatically after some time.

Climate control

Climate control systems	89
Heating and ventilation system .	89
Air conditioning system	90
Electronic climate control system	92
Auxiliary heater	96
Air vents	96
Adjustable air vents	96
Fixed air vents	97
Maintenance	97
Air intake	97
Air conditioning regular operation	97
Service	97

Climate control systems

Heating and ventilation system



Controls for:

- temperature (/ \)
- air distribution (windshield, head, foot, rear)
- fan speed (fan icon)
- demisting and defrosting (windshield with snowflake icon)
- heated rear window and exterior mirrors (rear window icon)

Heated rear window  ↻ 25.

Heated exterior mirrors  ↻ 22.

Temperature

Adjust the temperature by turning (/ \) to the desired temperature.

red area : warmer
blue area : colder

Heating will not be fully effective until the engine has reached normal operating temperature.

Air distribution

- (windshield and front door windows)
- (head area via adjustable air vents)
- (foot well and windscreen)

All combinations are possible.

Fan speed

Adjust the air flow by turning  to the desired speed.

clockwise : increase
anticlockwise : decrease

Demisting and defrosting



- Press : the air distribution is directed towards the windscreen.
- Set temperature controller to warmest level.
- Set fan speed to highest level.
- Switch on heated rear window
- Open side air vents as required and direct them towards the door windows.

Air conditioning system



Controls for:

- temperature
- air distribution , and
- fan speed
- demisting and defrosting
- cooling **A/C**
- air recirculation
- heated rear window and exterior mirrors
- heated seats

Heated rear window 25.

Heated exterior mirrors 22.

Heated seats 31.

Some setting changes are indicated briefly in the Info Display. Activated functions are indicated by the LED in the respective button.

Temperature

Adjust the temperature by turning to the desired temperature.

red area : warmer
blue area : colder

Heating will not be fully effective until the engine has reached normal operating temperature.

Air distribution

: to windscreen and front door windows

: to head area via adjustable air vents

: to foot well and windscreen

All combinations are possible.

Fan speed

Adjust the air flow by turning to the desired speed.

clockwise : increase
anticlockwise : decrease

Cooling A/C



Press **A/C** to switch on cooling. The LED in the button illuminates to indicate activation. Cooling is only functional when the engine is running and fan is switched on.

Press **A/C** again to switch off cooling. The air conditioning system cools and dehumidifies (dries) as soon as the outside temperature is slightly above the freezing point. Therefore, condensation may form and drip from under the vehicle.

If no cooling or drying is required, switch off the cooling system for fuel saving reasons.

Activated cooling may inhibit Autostops.

Stop-start system ⇨ 103.

Air recirculation system



Press  to activate air recirculation mode. The LED in the button illuminates to indicate activation.

Press  again to deactivate air recirculation mode.

Warning

The exchange of fresh air is reduced in air recirculation mode. In operation without cooling the air



humidity increases, so the windows may mist up from inside. The quality of the passenger compartment air deteriorates, which may cause the vehicle occupants to feel drowsy.

In warm and very humid ambient air conditions, the windscreen may mist up from outside when cold air is directed towards it. If windscreen mists up from outside, activate windscreen wiper and deactivate .

Maximum cooling



Briefly open the windows so that hot air can disperse quickly.

- Switch on cooling **A/C**.
- Press  for air recirculation system on.
- Press  for air distribution.

- Set temperature control (/ \) to coldest level.
- Set fan speed (⚙️) to highest level.
- Open all vents.

Heated rear window, windscreen and exterior mirrors  ↗ 25.

Heated seats  ↗ 31.



Demisting and defrosting the windows



- Press : the air distribution is directed towards the windscreen.
- Set temperature controller (/ \) to warmest level.
- Switch on cooling **A/C**, if required.
- Set fan speed (⚙️) to highest level.

- Switch on heated rear window .
- Open side air vents as required and direct them towards the door windows.

Note

If  is pressed while the engine is running, an Autostop will be inhibited until  is pressed again.

If  is pressed while the engine is in an Autostop, the engine will restart automatically.





Stop-start system ↗ 103.

Electronic climate control system



Controls for:

- temperature (/ \)
- **MENU** enters the Climate setting menu in the Info Display

- fan speed (⚙️)
- automatic mode **AUTO**
- cooling **A/C**
- manual air recirculation 
- demisting and defrosting 
- heated rear window and exterior mirrors 
- heated seats 

Heated rear window  ↗ 25.

Heated exterior mirrors  ↗ 22.

Heated seats  ↗ 31.

In automatic mode, temperature, fan speed and air distribution are regulated automatically.



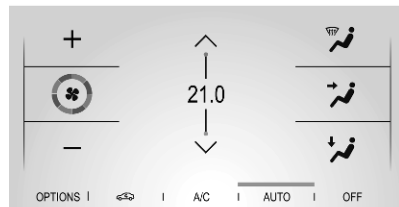

Activated functions are indicated by the LED in the respective control.

The electronic climate control system is only fully operational when the engine is running.

Climate control settings menu



Press **MENU** to manually set the following climate control functions:

- air distribution ,  and 
- fan speed 
- temperature (/ \)
- cooling **A/C**
- automatic mode **AUTO**

Climate setting menu can also be displayed in the Info Display.

Info Display  75.

Automatic mode AUTO



Basic setting for maximum comfort:

- Press **AUTO**, the air distribution and fan speed are regulated automatically.
- Open all air vents to allow optimised air distribution in automatic mode.
- Air conditioning must be activated for optimal cooling and demisting. Press **A/C** to switch on air conditioning. The LED in the button indicates activation.
- Set the preselected temperatures for the front seats using the left and right rotary ring. Recommended temperature is 22 °C.

Manual settings

Climate control system settings can be changed by activating the following functions:

Fan speed

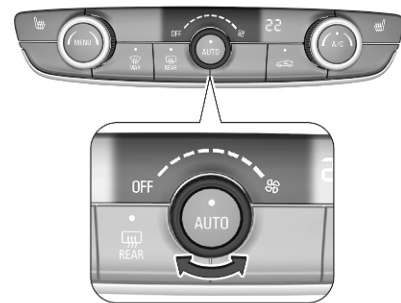

Adjust the air flow by turning rotary ring to the desired speed. Turn anticlockwise to decrease or turn clockwise to increase. Fan speed can also be changed in the climate settings menu. Press **MENU** to enter the menu.

Turn rotary ring anticlockwise as far as it will go: fan and cooling are switched off.

To return to automatic mode, press **AUTO**.



Air distribution   



MENU

Press **MENU** to enter the menu.

Touch in the Info Display:

-  : to windscreen and front door windows
-  : to head area and rear seats via adjustable air vents
-  : to front and rear foot well and windscreen

To return to automatic air distribution, press **AUTO**.

Temperature preselection  



Set the preselected temperatures to the desired value using the left or the right rotary ring.

Recommended temperature is 22 °C. The temperature is indicated in the display and in the climate settings menu.

If the minimum temperature **Lo** is set, the climate control system runs at maximum cooling, if cooling **A/C** is switched on.

If the maximum temperature **Hi** is set, the climate control system runs at maximum heating.

Note

If **A/C** is switched on, reducing the set cabin temperature can cause the engine to restart from an Autostop or inhibit an Autostop.

Stop-start system ↗ 103.

Air conditioning **A/C**



A/C

Press **A/C** to switch on cooling. The LED in the button illuminates to indicate activation. Cooling is only functional when the engine is running and climate control fan is switched on.

Press **A/C** again to switch off cooling.

The air conditioning system cools and dehumidifies (dries) when outside temperature is above a specific level. Therefore, condensation may form and drip from under the vehicle.

If no cooling or drying is required, switch off the cooling system for fuel saving reasons.

Manual air recirculation

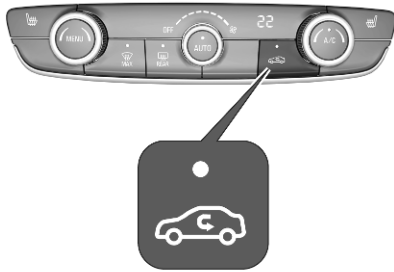

Press  to activate the air recirculation mode. The LED in the button illuminates to indicate activation.

Press  again to deactivate recirculation mode.

Warning

The exchange of fresh air is reduced in air recirculation mode. In operation without cooling, the air humidity increases, so the windows may mist up from inside. The quality of the passenger



compartment air deteriorates, which may cause the occupants to feel drowsy.

In warm and very humid ambient air conditions, the windscreen may mist up from outside, when cold air is directed towards it. If windscreen mists up from outside, activate windscreen wiper and deactivate .



Demisting and defrosting the windows





- Press . The LED in the button illuminates to indicate activation.
- Temperature and air distribution are set automatically and the fan runs at high speed.
- Switch on air conditioning by pressing **A/C**, if required.

- Switch on heated rear window  **REAR**.
- To return to previous mode, press  again. To return to automatic mode, press **AUTO**.

Note

If  is pressed while the engine is running, an Autostop will be inhibited until  is pressed again.

If  is pressed while the engine is in an Autostop, the engine will restart automatically.

Stop-start system  103.

Deactivation of electronic climate control system

Cooling, fan and automatic mode can be switched off by turning one of the rotary rings anticlockwise.

Activation by switching on the fan or pressing **AUTO**.

Heated rear window, windscreen and exterior mirrors   25.

Heated seats   31.

Auxiliary heater

Air heater

Quickheat is an electric auxiliary air heater which automatically warms up the passenger compartment more quickly.

Air vents

Adjustable air vents

Centre air vents in the instrument panel

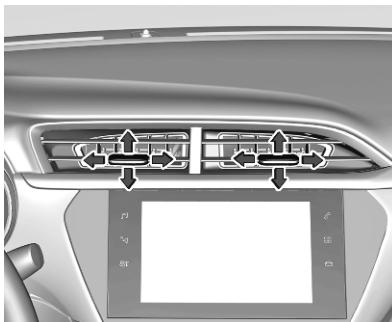

Direct the flow of air by tilting and swivelling the slats.

To close the vent, swivel the slats inwards.

Outer air vents in the instrument panel

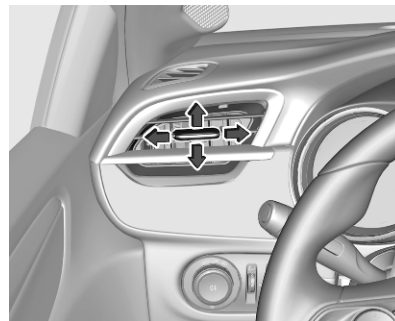

Direct the flow of air by tilting and swivelling the slats.

To close the vent, swivel the slats outwards.

At least two air vents must be open while cooling is on.

⚠ Warning

Do not attach any objects to the slats of the air vents. Risk of damage and injury in case of an accident.

Fixed air vents

Additional air vents are located beneath the windscreen and door windows and in the foot wells.

Maintenance

Air intake

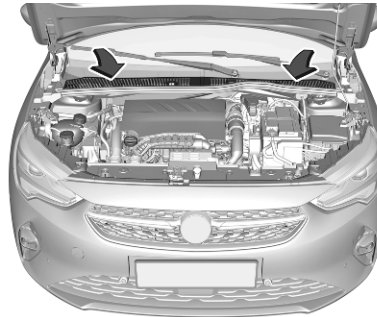

The air intake in front of the windscreen in the engine compartment must be kept clear to allow air intake. Remove any leaves, dirt or snow.

Air conditioning regular operation

In order to ensure continuously efficient performance, cooling must be operated for a few minutes once a month, irrespective of the weather and time of year. Operation with cooling is not possible when the outside temperature is too low.

Service

For optimal cooling performance, it is recommended to annually check the climate control system, starting three years after initial vehicle registration, including:

- functionality and pressure test
- heating functionality
- leakage check
- check of drive belts
- cleaning of condenser and evaporator drainage
- performance check

Driving and operating

Driving hints	99
Control of the vehicle	99
Steering	99
Starting and operating	99
New vehicle running-in	99
Ignition switch positions	99
Power button	100
Starting the engine	101
Overrun cut-off	103
Stop-start system	103
Parking	105
Engine exhaust	106
Exhaust filter	106
Catalytic converter	107
AdBlue	107
Automatic transmission	110
Transmission display	110
Gear selection	111
Manual mode	112
Electronic driving programmes	112
Fault	113
Interruption of power supply	113
Manual transmission	114

Brakes	115
Antilock brake system	115
Parking brake	115
Brake assist	118
Hill start assist	118
Ride control systems	118
Electronic Stability Control and Traction Control system	118
Driver assistance systems	120
Cruise control	120
Speed limiter	122
Adaptive cruise control	124
Active emergency braking	132
Forward collision alert	135
Front pedestrian protection	137
Parking assist	138
Advanced parking assist	141
Side blind spot alert	146
Panoramic view system	148
Rear view camera	150
Traffic sign assistant	151
Lane keep assist	152
Driver alert	154
Fuel	155
Fuel for petrol engines	155
Fuel for diesel engines	156
Refuelling	157
Trailer hitch	158
General information	158

Driving characteristics and towing tips	159
Trailer towing	159

Driving hints

Control of the vehicle

Never coast with engine not running

Many systems will not function in this situation (e.g. brake servo unit, power steering). Driving in this manner is a danger to yourself and others.

All systems function during an Autostop.

Stop-start system ⇨ 103.

Pedals

To ensure the pedal travel is uninhibited, there must be no mats in the area of the pedals.

Use only floor mats, which fit properly and are fixed by the retainers on the driver side.

Steering

If power steering assist is lost because the engine stops or due to a system malfunction, the vehicle can be steered but may require increased effort.

Starting and operating

New vehicle running-in

Do not brake unnecessarily hard for the first few journeys.

During the first drive, smoke may occur because of wax and oil evaporating off the exhaust system. Park the vehicle in the open for a while after the first drive and avoid inhaling the fumes.

During the running-in period, fuel and engine oil consumption may be higher.

Additionally, the cleaning process of the exhaust filter may take place more often.

Exhaust filter ⇨ 106.

Ignition switch positions

Turn key:

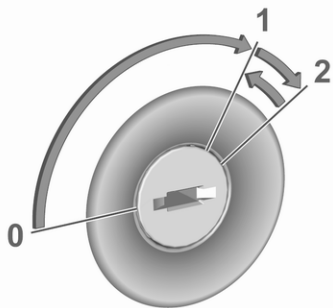

- 0 : ignition off: some functions remain active until key is removed or driver's door is opened, provided the ignition was on previously
- 1 : ignition on power mode: ignition is on, diesel engine is preheating, control indicators illuminate and most electrical functions are operable
- 2 : engine start: release key after engine has been started

Steering wheel lock

Remove key from ignition switch and turn steering wheel until it engages.

⚠ Danger

Never remove the key from ignition switch during driving as this will cause steering wheel lock.

Power button

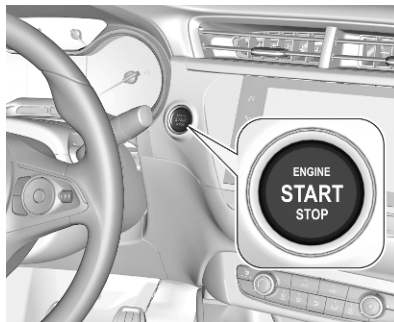

The electronic key or smart access device must be inside the vehicle.

Engine start

Operate the clutch pedal (manual transmission), the brake pedal and press **Start/Stop**.

Ignition on power mode without starting the engine

Press **Start/Stop** without operating clutch or brake pedal. Control indicators illuminate and most electrical functions are operable.

Engine and ignition off

Press **Start/Stop** briefly in each mode or when engine is running and vehicle is stationary. Some functions remain active until driver's door is opened, provided the ignition was on previously.

Emergency shut off during driving

Press **Start/Stop** for 5 seconds  101. Steering wheel locks as soon as vehicle is stationary.

Steering wheel lock

The steering wheel lock activates automatically when:

- The vehicle is stationary.
- The ignition has been switched off.

To release steering wheel lock, open and close driver's door and switch the ignition on power mode or start the engine directly.

⚠ Warning

If the vehicle battery is discharged, the vehicle must not be towed, tow-started or jump-started as the steering wheel lock cannot be disengaged.

Smart access

This function enables the starting of the vehicle via a mobile device. The vehicle is controlled via an application.

After entering into the vehicle and confirming a message, there are 10 seconds to start the vehicle.

When no message pops up, place the smart phone in the designated area.

Operation on vehicles with electronic key system in case of failure

If either the electronic key fails or the battery of the electronic key is weak, a message may be displayed in the Driver Information Centre.

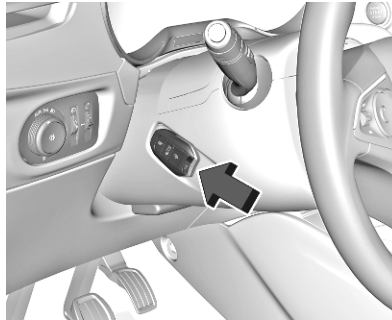

Hold the electronic key at the marking on the steering column cover as shown in the illustration.

On vehicles with manual transmission, select neutral gear, operate the clutch pedal, the brake pedal and press **Start/Stop**.

On vehicles with automatic transmission, set the selector lever to position **P**, operate the brake pedal and press **Start/Stop**.

This option is intended for emergencies only. Replace the electronic key battery as soon as possible ↪ 11.

For unlocking or locking the doors, see fault in radio remote control unit or electronic key system ↪ 12.

Starting the engine

Vehicles with ignition switch

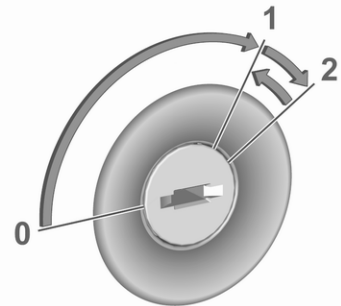

Turn key to position **1** to release the steering wheel lock.

Manual transmission: operate clutch and brake pedal.

Automatic transmission: operate brake pedal and move selector lever to **P** or **N**.

Do not operate accelerator pedal.

Diesel engines: wait until control indicator  extinguishes.

Turn key briefly to position **2** and release after engine has been started.

Manual transmission: during an Autostop, the engine can be started by depressing the clutch pedal  103.



Automatic transmission: during an Autostop, the engine can be started by releasing the brake pedal  103.

Vehicles with power button



- Manual transmission: select neutral gear, operate clutch and brake pedal.
- Automatic transmission: operate brake pedal and move selector lever to **P** or **N**.
- Do not operate accelerator pedal.
- Press **Start/Stop** button.
- Release button after starting procedure begins. Diesel engine starts after control indicator  for preheating extinguishes.
- Before restarting or to switch off the engine when vehicle is stationary, press **Start/Stop** once more briefly.

To start the engine during an Autostop:

- Manual transmission: during an Autostop, the engine can be started by depressing the clutch pedal  103.
- Automatic transmission: during an Autostop, the engine can be started by releasing the brake pedal  103.

Emergency shut off during driving

If the engine needs to be switched off during driving in case of emergency, press **Start/Stop** for 5 seconds.

Danger

Switching off the engine during driving may cause loss of power support for brake and steering systems. Assistance systems and airbag systems are disabled. Lighting and brake lights will extinguish. Therefore power down the engine and ignition while driving only when required in case of emergency.

Starting the vehicle at low temperatures

Starting the engine without additional heaters is possible down to -25°C for diesel engines and -30°C for petrol engines. Required is an engine oil with the correct viscosity, the correct fuel, performed services and a sufficiently charged vehicle battery. With temperatures below -30°C the automatic transmission requires a warming phase of approx. 5 minutes. The selector lever must be in position **P**.

Turbo engine warm-up

Upon start-up, engine available torque may be limited for a short time, especially when the engine temperature is cold. The limitation is to allow the lubrication system to fully protect the engine.

Overrun cut-off

The fuel supply is automatically cut off during overrun, i.e. when the vehicle is driven with a gear engaged but accelerator pedal is released.

Depending on driving conditions, the overrun cut-off may be deactivated.

Stop-start system

The stop-start system helps to save fuel and to reduce the exhaust emissions. When conditions allow, it switches off the engine as soon as the vehicle is at a low speed or at a standstill, e.g. at a traffic light or in a traffic jam.

Activation

The stop-start system is available as soon as the engine is started, the vehicle starts-off and the conditions as stated below in this section are fulfilled.



The system is ready to operate when the LED in the button A_{OFF} is not illuminated. To activate the system when the system is deactivated, press A_{OFF} .

If the stop-start system is temporarily not available and the button A_{OFF} is pressed, the LED in the button flashes.

Deactivation

Deactivate the stop-start system manually by pressing A_{OFF} . The deactivation is indicated when the LED in the button illuminates.

Autostop

Vehicles with manual transmission

Activate an Autostop as follows:

- Set the selector lever to neutral.
- Release the clutch pedal.

The engine will be switched off while the ignition stays on.

Vehicles with automatic transmission

If the vehicle is at a standstill with depressed brake pedal, Autostop is activated automatically.

The engine will be switched off while the ignition stays on.

The stop-start system will be disabled on steep inclines.

Indication



An Autostop is indicated by control indicator (A).

During an Autostop, the heating and brake performance will be maintained.

Conditions for an Autostop

The stop-start system checks if each of the following conditions is fulfilled.

- The stop-start system is not manually deactivated.
- The driver's door is closed or the driver's seat belt is fastened.
- The vehicle battery is sufficiently charged and in good condition.
- The engine is warmed up.
- The engine coolant temperature is not too high.
- The engine exhaust temperature is not too high, e.g. after driving with high engine load.
- The ambient temperature is not too low or too high.
- The climate control system allows an Autostop.
- The brake vacuum is sufficient.

- The self-cleaning function of the exhaust filter is not active.
- The vehicle was driven at least at walking speed since the last Autostop.

Otherwise an Autostop will be inhibited.

Note

The Autostop may be inhibited for several hours after a battery replacement or reconnection.

Certain settings of the climate control system may inhibit an Autostop.

Climate control ⇨ 90.

Immediately after higher speed driving an Autostop may be inhibited.

New vehicle running-in ⇨ 99.

Vehicle battery discharge protection

To ensure reliable engine restarts, several vehicle battery discharge protection features are implemented as part of the stop-start system.

Power saving measures

During an Autostop, several electrical features such as auxiliary electric heater or rear window heating are disabled or switched to a power saving mode. The fan speed of the climate control system is reduced to save power.

Restart of the engine by the driver

Vehicles with manual transmission

Depress the clutch pedal without depressing the brake pedal to restart the engine.

Vehicles with automatic transmission

The engine is restarted in the following cases:

- brake pedal released while the selector lever in position **D** or **M**
- brake pedal released or selector lever in position **N** when selector lever is moved to position **D** or **M**
- selector lever moved to position **R**

Restart of the engine by the stop-start system

The selector lever must be in neutral to enable an automatic restart.

If one of the following conditions occurs during an Autostop, the engine will be restarted automatically by the stop-start system:

- stop-start system manually deactivated
- driver's seat belt unfastened and driver's door opened
- engine temperature too low
- charging level of vehicle battery below a defined level
- brake vacuum not sufficient
- vehicle driven at least at walking speed
- climate control system requests engine start
- air conditioning manually switched on

If an electrical accessory, e.g. a portable CD player, is connected to the power outlet, a brief power drop during the restart might be noticeable.

Parking

Warning

- Do not park the vehicle on an easily ignitable surface. The high temperature of the exhaust system could ignite the surface.
- Always apply the parking brake.
- If the vehicle is on a level surface or uphill slope, engage first gear or set the selector lever to position **P**. On an uphill slope, turn the front wheels away from the kerb.
If the vehicle is on a downhill slope, engage reverse gear or set the selector lever to position **P**. Turn the front wheels towards the kerb.
- Close the windows.
- Switch off the engine.
- Remove the ignition key from the ignition switch or switch off ignition on vehicles with power

button. Turn the steering wheel until the steering wheel lock is felt to engage.

- Lock the vehicle.
- Activate the anti-theft alarm system.
- The engine cooling fans may run after the engine has been switched off ⇨ 163.

Caution

After running at high engine speeds or with high engine loads, operate the engine briefly at a low load or run in neutral for approx. 30 seconds before switching off, in order to protect the turbocharger.

Note

In the event of an accident with airbag deployment, the engine is switched off automatically if the vehicle comes to a standstill within a certain time.

In countries with extreme low temperatures it may be necessary to park the vehicle without applied parking brake. Make sure to park the vehicle on a level surface.

Engine exhaust

⚠ Danger

Engine exhaust gases contain poisonous carbon monoxide, which is colourless and odourless and could be fatal if inhaled.



If exhaust gases enter the interior of the vehicle, open the windows. Have the cause of the fault rectified by a workshop.

Avoid driving with an open load compartment, otherwise exhaust gases could enter the vehicle.

Exhaust filter

Automatic cleaning process

The exhaust filter system filters soot particles out of the exhaust gases.



The start of saturation of the exhaust filter is indicated by the temporary illumination of  or , accompanied by a message in the Driver Information Centre.

As soon as the traffic conditions permit, regenerate the filter by driving at a vehicle speed of at least 60 km/h until the control indicator extinguishes.

Note

On a new vehicle, the first exhaust filter regeneration operations may be accompanied by a burning smell, which is normal. Following prolonged operation of the vehicle at very low speed or at idle, water vapour can be emitted at the exhaust on acceleration. This does not affect the behaviour of the vehicle or the environment.

Cleaning process not possible

If  or  stays on, accompanied by an audible signal and a message, this indicates that the exhaust filter additive level is too low.

The reservoir must be topped-up without delay. Seek the assistance of a workshop.

Catalytic converter

The catalytic converter reduces the amount of harmful substances in the exhaust gases.

Caution

Fuel grades other than those listed on pages ⇨ 155, ⇨ 207 could damage the catalytic converter or electronic components.

Unburnt petrol will overheat and damage the catalytic converter. Therefore avoid excessive use of the starter, running the fuel tank dry and starting the engine by pushing or towing.

In the event of misfiring, uneven engine running, a reduction in engine performance or other unusual problems, have the cause of the fault rectified by a workshop as soon as possible. In an emergency, driving can be continued for a short period, keeping vehicle speed and engine speed low.

AdBlue

General information

The selective catalytic reduction (BlueInjection) is a method to substantially reduce the nitrogen oxides in the exhaust emission. This is achieved by injecting a Diesel Exhaust Fluid (DEF) into the exhaust system. The ammonia released by the fluid reacts with nitrous gases (NO_x) from the exhaust and turns it into nitrogen and water.

The designation of this fluid is AdBlue®. It is a non-toxic, non-flammable, colourless and odourless fluid which consists of 32% urea and 68% water.

Warning

Avoid contact of your eyes or skin with AdBlue.

In case of eye or skin contact, rinse off with water.

Caution

Avoid contact of the paintwork with AdBlue.

In case of contact, rinse off with water.

AdBlue freezes at a temperature of approx. -11 °C. As the vehicle is equipped with an AdBlue pre-heater, the emissions reduction at low temperatures is ensured. The AdBlue pre-heater works automatically.

Note

Frozen and again liquefied AdBlue is usable without quality loss.

The typical AdBlue consumption is approx. 0.85 l per 1000 km, but can also be higher depending on driving behaviour (e.g. high load or towing).

Level warnings

Depending on the calculated range of AdBlue, different messages are displayed in the Driver Information Centre. The messages and the restrictions are a legal requirement.

1. The first warning level is entered when the estimated AdBlue range is between 2400 km and 800 km.

When switching on the ignition, this warning will show up once briefly with the calculated range. Additionally, control indicator  will illuminate and a chime will sound. Driving is possible without any restrictions.

2. The next warning level is entered when the estimated AdBlue range is below 800 km. The message with the current range will always be displayed when ignition is switched on. Additionally, control indicator  will flash and a chime will sound. Refill AdBlue before entering the next warning level.

3. The next warning level is entered with a range below 100 km. The message with the current range will always be displayed when ignition is switched on. Additionally, control indicator  will flash and a chime will sound. Refill AdBlue as soon as possible before the AdBlue tank is

completely empty. Otherwise, a restart of the engine will not be possible.



4. The last warning level is entered when the AdBlue tank is empty. Restart of the engine is not possible.

A message appears in the Driver Information Centre. Additionally, control indicator  will flash and a chime will sound.

Refill the tank to a level of at least 5 l of AdBlue, otherwise restarting of the engine is not possible.

High emission warnings

In the event of a fault with the emissions control system, different messages are displayed in the Driver Information Centre.

The messages and the restrictions are a legal requirement. The warning messages are accompanied by the control indicators ,  and . Additionally, a chime will sound.

Follow the instructions of the warning messages. If starting is prevented, seek the assistance of a workshop.

Refilling AdBlue

Caution

Only use AdBlue that complies with European standards DIN 70 070 and ISO 22241-1.

Do not use additives.

Do not dilute AdBlue.

Otherwise the selective catalytic reduction system could be damaged.

Note

Whenever a filling pump with a nozzle for passenger cars is not available at a filling station, use only AdBlue bottles or canisters with a sealed refill adapter for refilling, to prevent splashback and overspill, and in order to ensure that the fumes from the tank are captured and do not emerge. AdBlue in bottles or canisters is available in many filling stations and can be purchased e.g. at Opel dealers and other retail outlets.

Since AdBlue has a limited durability, check the date of expiry before refilling.

Note

Refill the tank to a level of at least 5 l to ensure that the new AdBlue level is being detected.

In case AdBlue refill is not successfully detected:

1. Continuously drive the vehicle for 10 min making sure that vehicle speed is always higher than 20 km/h.
2. If AdBlue refill is detected successfully, AdBlue supply-driven warnings or limitations will disappear.

If AdBlue refill is still not detected, seek the assistance of a workshop.

If AdBlue must be refilled at temperatures below -11 °C, the refilling of AdBlue may not be detected by the system. In this event, park the vehicle in a space with a higher ambient temperature until AdBlue is liquified.

Note

When unscrewing the protective cap from the filler neck, ammonia fumes may emerge. Do not inhale as the fumes have a pungent smell. The fumes are not harmful by inhalation.

The AdBlue tank should be filled completely. This must be done if the warning message regarding prevention of an engine restart is already displayed.

The vehicle must be parked on a level surface.

The filler neck for AdBlue is located behind the fuel filler flap.

The fuel filler flap can only be opened if the vehicle is unlocked.

1. Switch off the ignition.
2. Close all doors to avoid ammonia fumes entering the interior of the vehicle.
3. Release the fuel filler flap by pushing the flap ↻ 157.

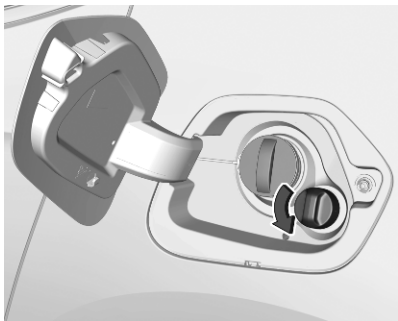

4. Unscrew protective cap from the filler neck.
5. Open AdBlue canister.
6. Mount one end of the hose on the canister and screw the other end on the filler neck.
7. Lift the canister until it is empty, or until the flow from the canister has stopped.
8. Place the canister on the ground to empty the hose, wait 15 seconds.
9. Unscrew the hose from the filler neck.
10. Mount the protective cap and turn clockwise until it engages.

Note

Dispose of AdBlue canister according to environmental requirements. Hose can be reused after flushing with clear water before AdBlue dries out.

Automatic transmission

The automatic transmission permits automatic gearshifting (automatic mode) or manual gearshifting (manual mode).

Manual shifting is possible in manual mode by pressing **M** on the selector wheel and shifting with the paddles **+** and **-** on the steering wheel.

Manual mode ⇨ 112.

Transmission display

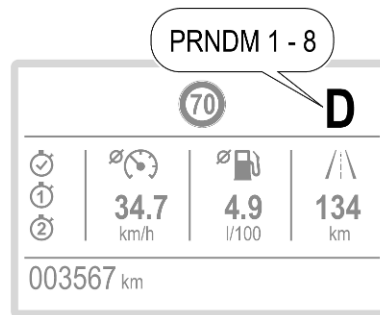

The mode or selected gear is shown in the Driver Information Centre.

In automatic mode, the driving programme is indicated by **D**.

In manual mode, **M** and the number of the selected gear is indicated.

R indicates reverse gear.

N indicates neutral position.

P indicates park position.

Gear selection

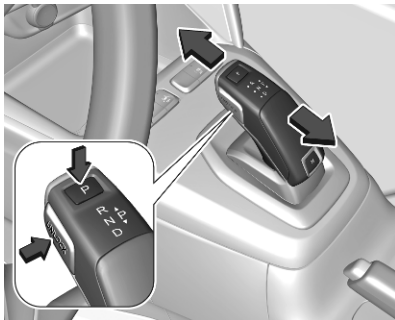

Move the selector lever or press the respective buttons as shown in the illustration above.

P : park position, front wheels are locked, engage only when the vehicle is stationary and the parking brake is applied

R : reverse gear, engage only when the vehicle is stationary

N : neutral

D : automatic mode

M : manual mode

+ : upshift in manual mode

- : downshift in manual mode

The selector lever is locked in **P**.

Before unlocking the gearbox, ensure that the ignition is on. Then, apply the brake pedal and press **UNLOCK**. Now, move the selector lever to the desired mode.

The engine can only be started with the selector lever in **P** or **N**. When position **N** is selected, press the brake pedal or apply the parking brake before starting.

Before engaging the reverse gear, come to a total stop. Then, apply the brake pedal and press **UNLOCK**. Now, move the selector lever to **R**.

Do not accelerate while engaging a gear. Never depress the accelerator pedal and brake pedal at the same time.

When a gear is engaged, the vehicle slowly begins to creep when the brake is released.

Engine braking

To utilise the engine braking effect, select a lower gear in good time when driving downhill.

Manual mode ⇨ 112.

Rocking the vehicle

Rocking the vehicle is only permissible if the vehicle is stuck in sand, mud or snow. Move the selector lever between **D** and **R** in a repeat pattern. Do not race the engine and avoid sudden acceleration.

Parking

Apply the parking brake and press **P**.

Manual mode

Manual mode **M** can be activated from position **D** in each driving situation and speed.

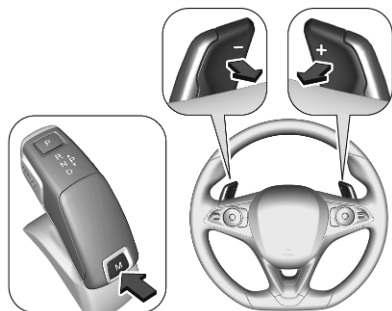

Press button **M**.

Pull steering wheel paddles to select gears manually.

Pull right paddle **+** to shift to a higher gear.

Pull left paddle **-** to shift to a lower gear.

Multiple pulls allow gears to be skipped.

The selected gear is indicated in the instrument cluster.

If a higher gear is selected when vehicle speed is too low, or a lower gear when vehicle speed is too high, the shift is not executed. This can cause a message in the Driver Information Centre.

In manual mode, no automatic shifting to a higher gear takes place at high engine revolutions.

Gear shift indication

The symbol ▲ or ▼ with a number beside it is indicated when gearshifting is recommended for fuel saving reasons.

Shift indication appears only in manual mode.

Electronic driving programmes

Following a cold start, the operating temperature programme increases engine speed to quickly bring the catalytic converter to the required temperature.

Special programmes automatically adapt the shifting points when driving up inclines or down hills.

In snowy or icy conditions or on other slippery surfaces, the electronic transmission control enables the driver to select manually first, second or third gear for starting off.

Kickdown

Pressing down the accelerator pedal beyond the kickdown detent will lead to maximum acceleration independent of selected driving mode. The transmission shifts to a lower gear depending on engine speed.

Drive modes

Four different drive modes are selectable:

- **Normal mode**
- **Comfort mode**
- **Sport mode**
- **Eco mode**

Each drive mode corresponds to a different vehicle setting.

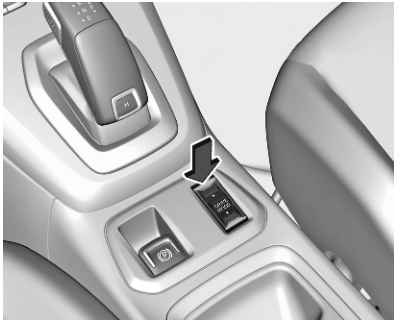

To select the respective drive mode, use the shown toggle switch.

Normal mode

The settings in this mode are set by default. Everytime the ignition is switched on, this mode is selected.

Comfort mode

Allows more comfortable driving and softer suspension.

Sport mode

The settings in this mode allow more dynamic driving. The vehicle's dynamic parameters can be displayed in the Driver Information Centre.

Eco mode

Reduces fuel consumption by optimising the operation of the heating and air conditioning and, depending on version, the accelerator pedal, the automatic gearbox and the gear shifting indicator.

Fault

In the event of a fault,  illuminates a message is displayed in the Driver Information Centre.

Vehicle messages ⇨ 76.

Electronic transmission control enables only third gear. The transmission no longer shifts automatically.

Do not drive faster than 100 km/h.

Have the cause of the fault remedied by a workshop.

Interruption of power supply

In the event of an interruption of power supply, the selector lever cannot be moved out of the P position.

Towing the vehicle ⇨ 192.

If the vehicle battery is discharged, start the vehicle using jump leads ⇨ 191.

If the vehicle battery is not the cause of the fault, seek the assistance of a workshop.

Manual transmission

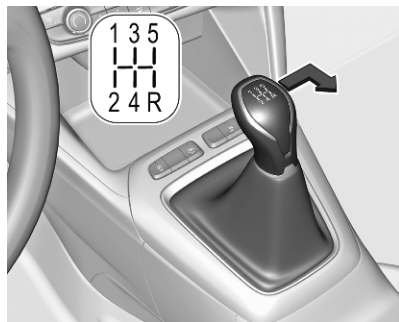

To engage reverse on 5-speed transmission, depress the clutch pedal and move the selector lever to the right and rear.



To engage reverse on 6-speed transmission, depress the clutch pedal, pull the ring under the selector lever and move the selector lever quite to the left and front.

If the gear does not engage, set the selector lever to neutral, release the clutch pedal and depress again. Then repeat gear selection.

Do not slip the clutch unnecessarily.

When operating, depress the clutch pedal completely. Do not use the pedal as a foot rest.

When clutch slip is detected for a specific time, the engine power will be reduced. A warning is displayed in the Driver Information Centre. Release the clutch.

Caution

It is not advisable to drive with the hand resting on the selector lever.

Gear shift indication ⇨ 70.

Stop-start system ⇨ 103.

Brakes

Antilock brake system

Antilock brake system (ABS) prevents the wheels from locking.

ABS starts to regulate brake pressure as soon as a wheel shows a tendency to lock. The vehicle remains steerable, even during hard braking.

ABS control is made apparent through a pulse in the brake pedal and the noise of the regulation process.

For optimum braking, keep the brake pedal fully depressed throughout the braking process, despite the fact that the pedal is pulsating. Do not reduce the pressure on the pedal.

When braking in an emergency, the hazard warning flashers are switched on automatically depending on the force of deceleration. They are switched off automatically the first time you accelerate.

After starting off, the system performs a self-test which may be audible.



Control indicator (ABS) ⇄ 69.

Fault

⚠ Warning

If there is a fault in the ABS, the wheels may be liable to lock due to braking that is heavier than normal. The advantages of ABS are no longer available. During hard braking, the vehicle can no longer be steered and may swerve.

Have the cause of the fault remedied by a workshop.

Parking brake

⚠ Warning

Before leaving the vehicle, check parking brake status. Control indicator (P) illuminate constantly when electric parking brake is applied.

Manual parking brake

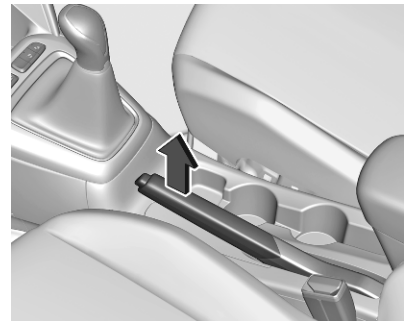

⚠ Warning

Always apply parking brake firmly without operating the release button, and apply as firmly as possible on a downhill or uphill slope.

To release the parking brake, pull the lever up slightly, press the release button and fully lower the lever.

To reduce the operating forces of the parking brake, depress the foot brake at the same time.

Control indicator (ⓘ) ⇨ 68.

Electric parking brake**Applying when vehicle is stationary****⚠ Warning**

Pull switch (ⓐ) for a minimum of 1 second until control indicator (ⓘ) illuminates constantly and electric parking brake is applied ⇨ 69. The electric parking brake operates automatically with adequate force. Before leaving the vehicle, check the electric parking brake status. Control indicator (ⓘ) ⇨ 69.

The electric parking brake can always be activated, even if the ignition is off.

Do not operate electric parking brake system too often without engine running as this will discharge the vehicle battery.

Releasing

Switch on ignition. Keep foot brake pedal depressed and then push switch (ⓑ).

Drive away function

Vehicles with manual transmission: Depressing the clutch pedal and then slightly releasing the clutch pedal and slightly depressing the accelerator pedal releases the electric parking brake automatically. This is only possible if the automatic operation of the electric parking brake is activated. It is not possible when switch (ⓑ) is pulled at the same time.

Vehicles with automatic transmission: Engaging **R**, **D** or **M** and then depressing the accelerator pedal releases the electric parking brake automatically. This is only possible if the automatic operation of the electric

parking brake is activated. It is not possible when switch (P) is pulled at the same time.

Braking when vehicle is moving

When the vehicle is moving and the switch (P) is kept pulled, the electric parking brake system will decelerate the vehicle. As soon as the switch (P) is released, braking will be stopped.

The antilock brake system and the Electronic Stability Control stabilise the vehicle while the switch (P) is kept pulled. If an error of the electric parking brake occurs, a warning message is displayed in the driver information centre. If the antilock brake system and the Electronic Stability Control fail, one or both indicators (ABS) and  illuminate in the instrument cluster. In this case, stability can only be provided by repeatedly pulling and pushing the switch (P) until the vehicle is immobilised.

Automatic operation

Automatic operation includes automatic application and automatic release of the electric parking brake.

The electric parking brake can also be applied or released manually by using the switch (P).

Automatic application:

- The electric parking brake is automatically applied when the vehicle is stationary and the ignition is switched off.
- (P) illuminates in the instrument cluster and a display message pops up to confirm the application.



Automatic release:

- Parking brake releases automatically after moving off.
- (P) extinguishes in the instrument cluster and a display message pops up to confirm the release.

If the vehicle is equipped with an automatic transmission and the brake is not released automatically, make sure the front doors are correctly closed.

Deactivation of automatic operation

1. Start the engine.
2. If the parking brake is released, apply the parking brake pulling the switch (P).
3. Take your foot off the brake pedal.
4. Press the switch (P) for at least 10 seconds and maximum 15 seconds.
5. Release the switch (P).
6. Press and hold the brake pedal.
7. Pull the switch (P) for 2 seconds.

The deactivation of the automatic operation of the electric parking brake is confirmed by  illuminating in the instrument cluster  69. The electric parking brake can only be applied and released manually.

To reactivate the automatic operation, repeat the steps described above.

Functionality check

When the vehicle is not moving, the electric parking brake might be applied automatically. This is done to check the system.

Fault

Failure mode of electric parking brake is indicated by a control indicator (P)! and by a vehicle message which is displayed in the Driver Information Centre.

Vehicle messages ⇨ 76.

Control indicator (P) flashes: electric parking brake is not fully applied or released. When continuously flashing, release electric parking brake and retry applying.

Brake assist

If brake pedal is depressed quickly and forcefully, maximum brake force is automatically applied.

Operation of brake assist might become apparent by a pulse in the brake pedal and a greater resistance when depressing the brake pedal.

Maintain steady pressure on the brake pedal as long as full braking is required. Maximum brake force is automatically reduced when brake pedal is released.

Hill start assist

The system helps prevent unintended movement when driving away on inclines.

When releasing the brake pedal after stopping on an incline, brakes remain on for further 2 seconds. The brakes release automatically as soon as the vehicle begins to accelerate.

Ride control systems

Electronic Stability Control and Traction Control system

Electronic stability control improves driving stability when necessary, regardless of the type of road surface or tyre grip.

As soon as the vehicle starts to swerve (understeer / oversteer), engine output is reduced and the wheels are braked individually.

Electronic stability control operates in combination with the traction control system. It prevents the driven wheels from spinning.

The traction control system is a component of the electronic stability control.

The traction control system improves driving stability when necessary, regardless of the type of road surface or tyre grip, by preventing the driven wheels from spinning.

As soon as the driven wheels starts to spin, engine output is reduced and the wheel spinning the most is braked

individually. This considerably improves the driving stability of the vehicle on slippery road surfaces.



Electronic stability control and the traction control system are operational after each engine start as soon as the control indicator  extinguishes.

When electronic stability control and the traction control system operate,  flashes.

Warning

Do not let this special safety feature tempt you into taking risks when driving.

Adapt speed to the road conditions.

Control indicator  \rightarrow 70.

Deactivation

Electronic stability control and the traction control system can be deactivated in the Info Display.

Info Display \rightarrow 75.

 illuminates and a message is displayed in the Driver Information Centre.

Electronic stability control and the traction control system are reactivated everytime the ignition has been switched on again or in the case that the vehicle is driven faster than 50 km/h. It can also be reactivated via the Info Display.

 extinguishes when the electronic stability control and the traction control system are reactivated.

Fault

If there is a fault in the system, the control indicator  illuminates continuously, a message appears in the Driver Information Centre and a warning chime sounds. The system is not operational.

Have the cause of the fault remedied by a workshop.

Driver assistance systems

⚠ Warning

Driver assistance systems are developed to support the driver and not to replace the driver's attention.

The driver accepts full responsibility when driving the vehicle.

When using driver assistance systems, always take care regarding the current traffic situation.

Cruise control

The cruise control can store and maintain speeds above 40 km/h. Additionally, at least the third gear must be engaged on some manual transmissions. On automatic transmissions, position **D** or the second or a higher gear in position **M** must be selected.

Deviations from the stored speeds may occur when driving uphill or downhill.

The system maintains the vehicle speed at the preset speed by the driver, without any action on the accelerator pedal.

The preset speed can be exceeded temporarily by pressing the accelerator pedal firmly.

The status and preset speed is displayed in the Driver Information Centre.

Do not use the cruise control if it is not advisable to maintain a constant speed.

Switching on the system

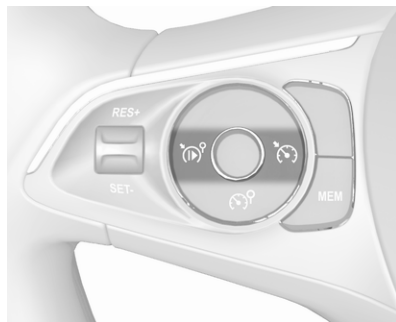

Press .

Symbol  and a message are displayed in the Driver Information Centre. The system is still not active.

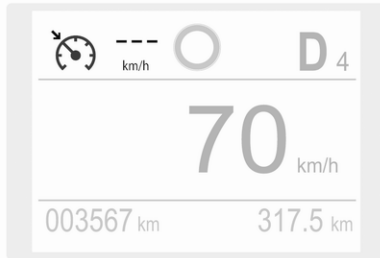

Activation of the functionality

Setting speed by the driver

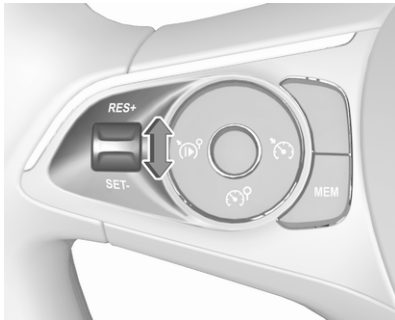

Accelerate to the desired speed and move thumb wheel once briefly to **SET/-**. The current speed is stored and maintained. Accelerator pedal can be released.

The preset speed can then be changed by moving thumb wheel to **RES/+** to increase or **SET/-** to decrease the speed. Move thumb wheel repeatedly to change speed in small steps, move and hold to change speed in large steps.

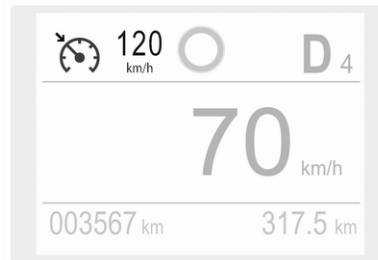

Speed value is indicated in the Driver Information Centre.

Adopting speed by the speed limit recognition

The intelligent speed adaptation informs the driver when a speed limit is detected by the speed limit recognition. The detected speed limit can be used as new value for the cruise control.

Using the camera at the top of the windscreen, this system detects and reads speed limit and end of speed limit signs.

With active cruise control the recognised speed limit will be displayed in the Driver Information Centre and **MEM** illuminates if the difference between set speed and speed limit is more than 9 km/h.

Press **MEM** on the steering wheel to request saving of the suggested speed.

Press **MEM** on the steering wheel once more to confirm and save the new speed setting.

This speed is the new value for the cruise control.

The function can be deactivated or activated in the vehicle personalisation ↷ 77.

Exceeding the set speed

Vehicle speed can be increased by depressing the accelerator pedal. When the accelerator pedal is released, the previously stored speed is resumed.

Deactivation of the functionality

Press , cruise control is in pause mode and a message is displayed. The vehicle is driven without cruise control.

Cruise control is deactivated, but not switched off. Last stored speed remains in memory for later speed resume.

Cruise control is deactivated automatically in the following cases:

- The brake pedal is depressed.
- Vehicle speed is below 40 km/h.
- The traction control system or electronic stability control is operating.

- The selector lever is in **N** (automatic transmission) or the first or second gear (on some manual transmissions) is engaged.
- Immediately after the clutch pedal has been depressed or a few seconds after the clutch pedal has been depressed (depending on the manual transmission).

Resume stored speed

Move thumb wheel to **RES/+** at a speed above 40 km/h. The stored speed will be obtained.

Switching off the system

Press , the cruise control mode is deselected and the cruise control indication extinguishes in the Driver Information Centre.

Pressing  to activate the speed limiter deactivates cruise control.

Switching off the ignition cancels any programmed speed value.

Fault

In the event of a cruise control fault, the speed is cleared resulting in flashing of the dashes.

The speed limit recognition may not operate correctly if traffic signs do not comply with the Vienna Convention on Road Signs and Signals.

Speed limiter

The speed limiter prevents the vehicle from exceeding a preset maximum speed.

The maximum speed can be set at speeds above 30 km/h.

The driver can accelerate the vehicle up to the preset speed. Deviations from the limited speed may occur when driving downhill.

The preset speed can be exceeded temporarily by pressing the accelerator pedal firmly.

The status and preset speed limit are displayed in the Driver Information Centre.

Switching on the system

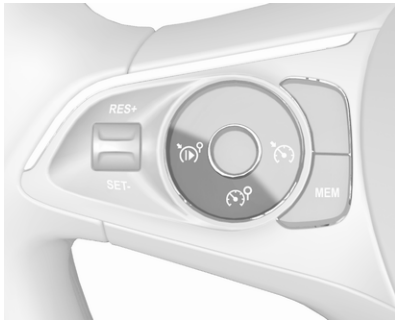

Press .

 and a message are displayed in the Driver Information Centre. The system is still not active.

Activation of the functionality

Setting speed by the driver

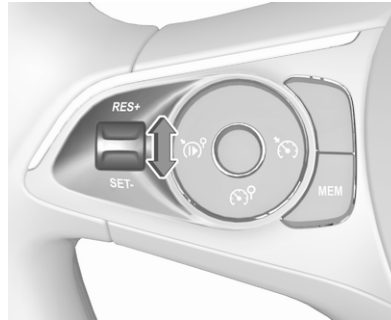

The preset maximum speed can be set by pressing thumb wheel to **RES/+** to increase or **SET/-** to decrease the desired maximum speed. Move thumb wheel repeatedly to change speed in small steps, move and hold to change speed in large steps.

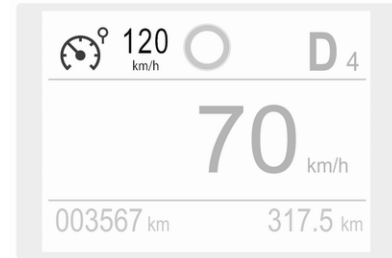

Speed value is indicated in the Driver Information Centre.

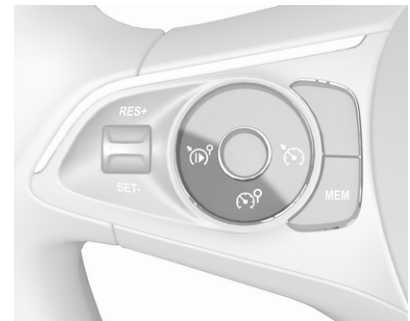

Press  to activate speed limiter.

Adopting speed by the speed limit recognition

The intelligent speed adaptation informs the driver when a speed limit is detected by the speed limit recognition. The detected speed limit can be used as new value for the speed limiter.

Using the camera at the top of the windscreen, this system detects and reads speed limit and end of speed limit signs.

If the speed limiter is active, the recognised speed limit will be displayed in the Driver Information Centre and **MEM** illuminates if the difference between set speed and speed limit is more than 9 km/h.

Press **MEM** on the steering wheel to request saving of the suggested speed limit.

Press **MEM** on the steering wheel once more to confirm and save the new speed setting.

This speed is the new value for the speed limiter.

The function can be activated or deactivated in the vehicle personalisation ↷ 77.

Exceeding the speed limit

In the event of an emergency, it is possible to exceed the speed limit by depressing the accelerator pedal firmly to the final point. In this case, the preset speed value flashes.

Release the accelerator pedal and the speed limiter function is reactivated once a speed lower than the limit speed is obtained.

Deactivation of the functionality

Press , speed limiter is in pause mode and a message is displayed. The vehicle is driven without speed limiter.

Speed limiter is deactivated, but not switched off. Last stored speed remains in memory for later speed resume.

Resume limit speed

Press , the stored speed limit will be obtained.

Switching off the system

Press , the speed limiter mode is deselected and the speed limit indication extinguishes in the Driver Information Centre.

Pressing  to activate cruise control deactivates speed limiter.

The preset speed remains in the memory when the ignition is switched off.

Fault

In the event of a speed limiter fault, the speed is cleared resulting in flashing of the dashes.

The speed limit recognition may not operate correctly if traffic signs do not comply with the Vienna Convention on Road Signs and Signals.

Adaptive cruise control

The adaptive cruise control is an enhancement to the conventional cruise control with the additional feature of maintaining a certain following distance to the vehicle ahead.



It uses radar and camera sensors to detect the vehicles ahead. If no vehicle is detected in the driving path, the adaptive cruise control will behave like a conventional cruise control.

The adaptive cruise control automatically decelerates the vehicle when approaching a slower moving vehicle. It then adjusts the vehicle speed to follow the vehicle ahead at the selected following distance. The vehicle speed increases or decreases to follow the vehicle ahead, but will not exceed the set speed. It may apply limited braking with activated brake lights.

If the vehicle ahead accelerates or changes lane, the adaptive cruise control progressively accelerates the vehicle to return to the stored set speed. If the driver operates the turn lights to overtake a slower vehicle, the

adaptive cruise control allows the vehicle to temporarily approach the vehicle ahead to help passing it. However, the set speed will never be exceeded.

The adaptive cruise control can store set speeds over 30 km/h for manual transmission. If the vehicle ahead is moving too slowly and the selected following distance cannot be maintained anymore, a warning chime is given and a message is displayed in the Driver Information Centre. The message prompts the driver to take back control of the vehicle. On vehicles with automatic transmission, the system can brake the vehicle until a full stop.

⚠ Warning

The complete driver attention is always required while driving with adaptive cruise control. The driver stays fully in control of the vehicle because the brake pedal, the accelerator pedal and the button  have priority over any adaptive cruise control operation.

Switching on the system

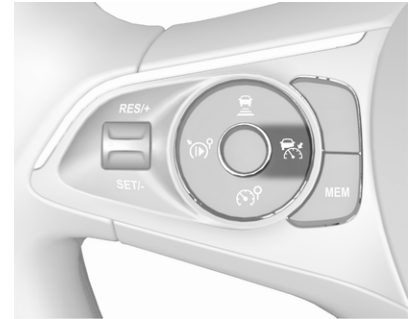

Press .

 is indicated in the Driver Information Centre. The system is still not active.

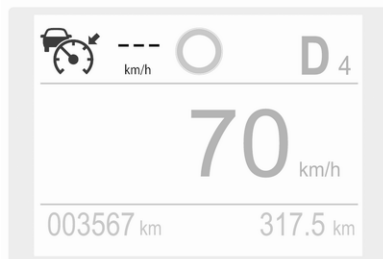

Activation of the functionality

Setting speed by the driver

The adaptive cruise control has to be switched on manually at a speed between 30 km/h and 180 km/h. For vehicles with automatic transmission, the automatic selector lever must be in position **D** or **M**.

Accelerate to the desired speed and move the thumb wheel to **SET/-**. The current speed is stored and maintained.

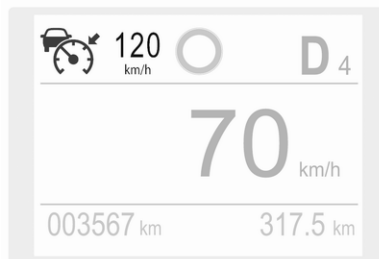

The speed value is indicated in the Driver Information Centre.

The preset speed can then be changed by moving thumb wheel to **RES/+** to increase or **SET/-** to decrease the speed. Move thumb wheel repeatedly to change speed in small steps, move and hold to change speed in large steps.

When the adaptive cruise control is operating, the stop-start system is automatically deactivated.

Adopting speed by the speed limit recognition

The intelligent speed adaptation informs the driver when a speed limit is detected by the speed limit recognition. The detected speed limit can be taken over as new set speed for the adaptive cruise control.

Using the camera at the top of the windscreen, this system detects and reads speed limit and end of speed limit signs.

If the adaptive cruise control is active, the recognised speed limit will be displayed in the Driver Information Centre and **MEM** illuminates if the difference between set speed and speed limit is more than 9 km/h.

Press **MEM** on the steering wheel to request saving of the suggested speed.

Press **MEM** on the steering wheel once more to confirm and save the new speed setting.

This speed limit is now the new set speed of the adaptive cruise control.

The function can be activated or deactivated in the vehicle personalisation ⇨ 77.

Overriding set speed

It is always possible to drive faster than the selected set speed by depressing the accelerator pedal. When the accelerator pedal is released, the vehicle returns to the stored speed. If a slower moving vehicle is ahead, the following distance selected by the driver is restored.

If the set speed is exceeded, the indicated speed setting disappears and a warning message is displayed.

Warning

Accelerating by the driver deactivates automatic braking by the system. This is indicated as a pop-up warning in the Driver Information Centre.

Resuming stored speed

Move the thumb wheel to **RES/+** at a speed above 30 km/h. The adaptive cruise control is activated with the stored set speed.

Adaptive cruise control on vehicles with automatic transmission

For vehicles with automatic transmission, adaptive cruise control allows to maintain the selected distance behind a braking vehicle until a complete stop is reached.

If the system has stopped your vehicle behind another vehicle, then the set speed is replaced by a green control indicator (A). This symbol notifies, that the vehicle is hold automatically in stop position.

When the vehicle ahead drives away within some seconds and the traffic conditions allow a restart of the vehicle, then active cruise control is resumed automatically.

If the stopped vehicle ahead was stopped for a longer time and then begins to move forward, the green

control indicator (A) will flash and a warning chime will sound as a reminder to check traffic before resuming.

When the vehicle ahead drives away, depress the accelerator pedal or press (D) to resume adaptive cruise control.

If the vehicle stays stopped for more than 5 minutes or if the driver's door is opened and the driver's seat belt is unfastened, then the electric parking brake is applied automatically to hold the vehicle. Control indicator (P) will illuminate. To release electric parking brake, press the accelerator pedal.

Electric parking brake ⇨ 115.

Warning

When the system is deactivated or cancelled, the vehicle will no longer be held at a stop and can

start moving. Be always prepared to manually apply the brake to hold the vehicle stationary.

Do not leave the vehicle while it is being held at a stop by adaptive cruise control. Always move selector lever to park position **P** and switch off the ignition before leaving the vehicle.

Setting the following distance

When adaptive cruise control detects a slower moving vehicle in the driving path, it will adjust the vehicle speed to maintain the following distance selected by the driver.

The following distance can be set to close (1 bar), normal (2 bars) or far (3 bars).

If the engine is running and the adaptive cruise control is enabled (grey) or active (green), you can modify the following distance setting:

Press , the current setting is shown in the Driver Information Centre.



Press  again to change the following distance: The new setting is displayed in the Driver Information Centre.

The selected following distance is indicated by full bars in the adaptive cruise control page.

Warning

The driver accepts full responsibility for the appropriate following distance based on traffic, weather and visibility conditions. Following distance must be adjusted or the system switched off when required by the prevailing conditions.

Detecting the vehicle ahead

If the system detects a vehicle in the driving path, the adaptive cruise control symbol displayed in the Driver Information Centre changes:  is changed to .

Deactivation of the functionality

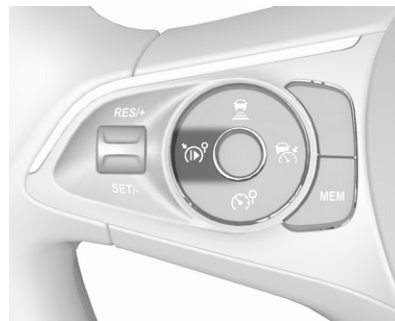

Press , the adaptive cruise control is in pause mode and a message is displayed. The vehicle is driven without adaptive cruise control.

The adaptive cruise control is deactivated, but not disabled. The last stored set speed remains in memory for later usage.

The adaptive cruise control is deactivated automatically in the following cases:

- The brake pedal is depressed.

- The vehicle accelerates above 180 km/h (manual and automatic transmission) or slows down below 30 km/h (manual transmission).
- The electric parking brake is applied.
- The traction control system or electronic stability control is deactivated or operating.
- The selector lever of automatic transmissions is neither in **D** nor in **M**.
- A fault is detected in the electronic stability control or the radar system.
- Immediately after the clutch pedal has been depressed or a few seconds after the clutch pedal has been depressed (depending on the manual transmission).

Switching off the system

Press , the adaptive cruise control mode is disabled and the adaptive cruise control indication extinguishes in the Driver Information Centre.

Pressing  to activate the speed limiter deactivates adaptive cruise control.

Switching off the ignition deletes the stored set speed.

Driver's attention

- Use the adaptive cruise control carefully on bends or mountain roads, as it can lose the vehicle ahead and needs time to detect it again.
- Do not use the system on slippery roads as it can create rapid changes in tyre traction (wheel spinning), so that you could lose control of the vehicle.
- Do not use the adaptive cruise control during rain, snow or heavy dirt, as the radar sensor can be covered by a water film, dust, ice or snow. This reduces or suppresses completely the visibility. In case of sensor blockage, clean the sensor cover.
- Do not use the system when the spare wheel is in use.

System limits

Warning

The system's automatic brake force does not permit hard braking and the braking level may not be sufficient to avoid a collision.

- After a sudden lane change, the system needs a certain time to detect the next preceding vehicle. So if a new vehicle is detected, the system may accelerate instead of braking.
- The adaptive cruise control does ignore the oncoming traffic.
- The adaptive cruise control does not consider pedestrians and animals for braking and driving off.
- The adaptive cruise control considers stopped vehicles only at low speed.

- Do not use the adaptive cruise control when towing a trailer.
- Do not use the adaptive cruise control on roads with an incline of more than 10%.

As the radar's field of detection is quite narrow, it is possible that the system may not detect:

- vehicles of reduced width, e.g. motorcycles, scooters
- vehicles not running in the middle of the lane
- vehicles entering a corner
- vehicles suddenly pulling out

Bends

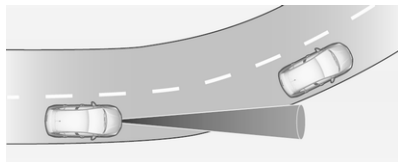

The adaptive cruise control calculates a predicted path based on the centrifugal force. This predicted path considers the current bend characteristic, but cannot consider a

future bend change. The system may lose the current vehicle ahead or consider a vehicle which is not in the actual lane. This can happen when entering or exiting a bend or if the bend gets stronger or weaker. If it no longer detects any vehicle ahead, then 🚲 will extinguish.

If the centrifugal force is too high in a bend, the system slows down the vehicle slightly. This braking level is not designed to avoid spinning-off the bend. The driver is responsible for reducing the selected speed before entering a bend and in general to adapt the speed to the road type and to existing speed limits.

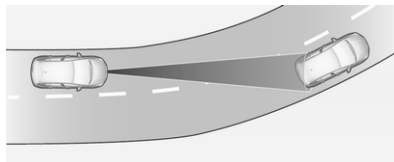

Motorways

On motorways, adapt the set speed to the situation and the weather. Always consider that adaptive cruise control has a limited visibility range, a

limited braking level and a certain reaction time to verify if a vehicle is on the driving path or not. Adaptive cruise control may not be able to brake the vehicle in time to avoid a collision with a much slower vehicle or after a lane change. This is particularly true while driving fast or if the visibility is reduced due to weather conditions.

While entering or exiting a motorway, adaptive cruise control may lose the vehicle ahead and accelerate up to the set speed. For this reason, decrease the set speed before the exit or before the entry.

Vehicle path changes

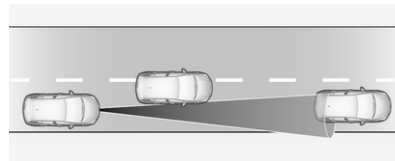

If another vehicle enters your driving path, adaptive cruise control will first consider the vehicle when it is completely in your path. Be ready to

take action and depress the brake pedal if you need to brake more quickly.

Hill considerations



⚠ Warning

Do not use the adaptive cruise control on steep hill roads.

System performance on hills depends on vehicle speed, vehicle load, traffic conditions and the road gradient. It may not detect a vehicle in your path while driving on hills. On steep hills, you may have to use the accelerator pedal to maintain your vehicle speed. When going downhill you may have to brake to maintain or reduce your speed.

Note that applying the brake deactivates the system.

Radar unit



The radar unit is located in the middle of the front bumper.

⚠ Warning

The radar unit was aligned carefully during manufacture. Therefore, in the event of a front-end impact, do not use the system. The front bumper may appear to be intact, however the sensor behind may be affected and react incorrectly. After an accident, consult a workshop to verify and adjust the radar unit position.

⚠ Warning

The usage of a license plate support may have an impact on the proper operation of the radar unit and may limit sensor performance. Vehicles driving ahead, pedestrians or other objects located in front of the vehicle may not be detected by the system.

Do not use a license plate support on the front bumper to ensure proper system functionality.

Fault

In the event of a fault with the adaptive cruise control, you are alerted by the illumination of a warning light and the display of a message in the instrument panel, accompanied by an audible signal.

The adaptive cruise control may not operate correctly if traffic signs do not comply with the Vienna Convention on Road Signs and Signals.

Have the system checked by a dealer or a qualified workshop.

As a safety measure, do not use the system if the brake lights are faulty. Do not use the system if the front bumper is damaged.

Active emergency braking

Active emergency braking can help to reduce the damage and injury from crashes with vehicles and pedestrians directly ahead, when the driver does not actively take action either by manual braking or by steering. Before the active emergency braking applies, the driver is warned by the forward collision alert.

Forward collision alert ⇨ 135

Front pedestrian protection ⇨ 137

Active emergency braking can be deactivated in the vehicle personalisation ⇨ 77. If deactivated,  illuminates in the instrument cluster and a warning message is displayed in the Driver Information Centre. When ignition is switched on next time, system is activated.

The feature uses various inputs (e.g. camera sensor, radar sensor, brake pressure, vehicle speed) to calculate the probability of a frontal collision.

Warning

This system is not intended to replace the driver responsibility for driving the vehicle and looking ahead. Its function is limited to supplemental use only to reduce the vehicle speed before a collision.

The system may not react to animals. After a sudden lane change, the system needs a certain time to detect the next preceding vehicle.

The driver must always be ready to take action and apply the brakes and steer to avoid collisions.

Warning

The usage of a license plate support may have an impact on the proper operation of the radar

unit and may limit sensor performance. Vehicles or pedestrians driving or walking ahead may not be detected by the system.

Do not use a license plate support to ensure proper system functionality.

Functionality

Depending on the vehicle configuration and the detected objects, there are several operational speed ranges.

On vehicles equipped only with front camera, the active emergency braking operates from 5 km/h to 80 km/h when a vehicle has been detected.

On vehicles equipped with radar sensor and front camera, the active emergency braking operates from 5 km/h to 140 km/h when a vehicle has been detected.

Active emergency braking only works when the seat belts of the front passengers are fastened.

The system includes:

- brake preparation system
- emergency automatic braking
- smart brake assist
- forward collision alert
- front pedestrian protection

Brake preparation system

When approaching a vehicle ahead or a pedestrian so quickly that a collision is likely, the brake preparation system slightly pressurises the brakes. This reduces the response time, when braking is requested.

Emergency automatic braking

After activation of brake preparation system and just before the imminent collision, this function automatically applies limited braking to reduce the impact speed of the collision or prohibit a crash.

If active emergency braking is applied,  flashes in the instrument cluster.

Emergency automatic braking can only occur if a vehicle or a pedestrian ahead is detected.

Forward collision alert ⇨ 135

Front pedestrian protection ⇨ 137

Below a speed of 30 km/h, emergency automatic braking may slow down the vehicle to a complete stop. If the speed exceeds 30 km/h, emergency automatic braking reduces the speed. However, the driver must apply the brake.

Emergency automatic braking may slow the vehicle to a complete stop to try to avoid a potential crash.

- Automatic transmission: If the vehicle comes to a complete stop, automatic braking is maintained for up to two seconds. Keep the brake pedal depressed to prevent the vehicle from starting off again.
- Manual transmission: If the vehicle comes to a complete stop, the engine may stall.

Operation of the function may be felt by a slight vibration in the brake pedal.

Warning

Emergency automatic braking is an emergency crash preparation feature and is not designed to avoid crashes. Do not rely on the system to brake the vehicle. Emergency automatic braking will not brake outside of its operating speed range and only responds to detected vehicles and pedestrians.

Smart brake assist

Smart brake assist provides a boost to braking when the brake pedal is quickly applied. The braking is based on the speed of approach and distance to a vehicle ahead.

Minor brake pedal pulsations or pedal movement during this time is normal and the brake pedal should continue to be applied as needed. Intelligent brake assist will automatically disengage only when the brake pedal is released.

⚠ Warning

Smart brake assist may increase vehicle braking in situations when it may not be necessary. You could block the flow of traffic. If this occurs, take your foot off the brake pedal and then apply the brakes as needed.

Forward collision alert ⇨ 135.

Front pedestrian protection ⇨ 137.

System limitations

In some cases, the active emergency braking system may provide an automatic braking in situations that seem to be unnecessary, for instance in parking garages, due to various types of objects, i.e., traffic signs or vehicles in another lane. This is normal operation, the vehicle does not need service. Firmly apply the accelerator pedal to override the automatic braking if the situation and the surroundings permit.

In the following cases, active emergency braking performance might be limited:

- driving on winding or hilly roads
- detecting vehicles with a trailer, tractors, muddy vehicles, etc.
- detecting a vehicle when weather limits visibility, such as in fog, rain, or snow
- driving during nighttime
- the sensor in the windscreen or the radar unit behind the front bumper are blocked by snow, ice, slush, mud, dirt etc.
- the windscreen is damaged or affected by foreign objects, e.g. stickers
the bumper is damaged or affected by foreign objects, e.g. license plate support

Complete attention is always required while driving, and you should be ready to take action and apply the brakes and / or steer the vehicle to avoid crashes.

We recommend to deactivate the system in the vehicle personalisation in the following cases:

- when towing a trailer or caravan
- when carrying long objects on roof bars or a roof rack
- when the vehicle is being towed with the engine running
- when the vehicle is fitted with snow chains
- when a spare wheel is fitted that is smaller than the other wheels
- before using an automatic car wash with the engine running
- before placing the vehicle on a rolling road in a workshop
- if the windscreen has been damaged close to the camera
- if the front bumper has been damaged
- if the brake lights are not working

Fault

In case the system requires a service, a message is displayed in the Driver Information Centre.

If the system does not work properly, vehicle messages are displayed in the Driver Information Centre.

Vehicle messages ⇨ 76.

Forward collision alert

The forward collision alert may help to avoid or reduce the harm caused by front-end crashes.

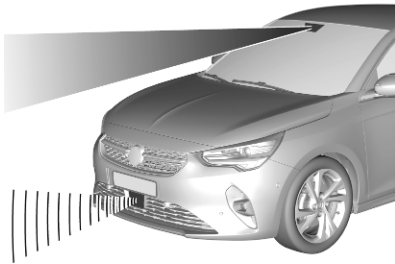

The forward collision alert uses the front camera in the windscreen and depending on the vehicle configuration a radar unit located behind the front bumper to detect a vehicle directly ahead, in the path.

If a vehicle directly ahead is approached too quickly, a warning chime sounds and a message is displayed in the Driver Information Centre.

⚠ Warning

Forward collision alert is just a warning system and does not apply the brakes. When approaching a vehicle ahead too rapidly, it may not provide you enough time to avoid a collision.

The driver accepts full responsibility for the appropriate following distance based on traffic, weather and visibility conditions.

The complete attention of the driver is always required while driving. The driver must always be ready to take action and apply the brakes.

⚠ Warning

The usage of a license plate support may have an impact on the proper operation of the radar unit and may limit sensor performance. Vehicles driving ahead, pedestrians or other objects located in front of the vehicle may not be detected by the system.

Do not use a license plate support on the front bumper to ensure proper system functionality.

Activation



Depending on the vehicle configuration and the detected objects, there are several operational speed ranges.

On vehicles equipped only with front camera, the forward collision alert operates from 5 km/h to 80 km/h when a vehicle has been detected.

On vehicles equipped with radar sensor and front camera, the forward collision alert operates from 5 km/h to 140 km/h when a vehicle has been detected.

Alerting the driver

The driver is warned by following alerts:

- Symbol  and a warning message are displayed in the Driver Information Center, when the distance to the vehicle ahead gets to small.
- Symbol  and a warning message are displayed in the Driver Information Center and a warning chime sounds, when a collision is imminent and immediate driver's action is required.

Warning

Forward collision alert is just a warning system and does not apply the brakes. When

approaching a vehicle ahead too rapidly, it may not provide you enough time to avoid a collision.

The driver accepts full responsibility for the appropriate following distance based on traffic, weather and visibility conditions.

The complete attention of the driver is always required while driving. The driver must always be ready to take action and apply the brakes.

Warning

The usage of a license plate support may have an impact on the proper operation of the radar unit and may limit sensor performance. Vehicles or pedestrians driving or walking ahead may not be detected by the system.

Do not use a license plate support to ensure proper system functionality.

Selecting the alert sensitivity

Three alert sensitivities can be selected in the settings of the active emergency braking within the vehicle personalisation  77.

The chosen setting will be memorised when the ignition has been switched off. The alert timing will vary based on selected alert setting and vehicle speed. Consider traffic and weather conditions when selecting the alert timing.

Deactivation

The system can only be deactivated by deactivating the active emergency braking in the vehicle personalisation  77. When ignition is switched on next time, system is activated.

System limitations

Forward collision alert is designed to warn on vehicles, but may react also to other objects.

In the following cases, forward collision alert may not detect a vehicle ahead or sensor performance is limited:

- driving on winding or hilly roads
- driving during nighttime
- weather limits visibility, such as fog, rain, or snow
- the sensor in the windscreen or the radar unit behind the front bumper are blocked by snow, ice, slush, mud, dirt etc.
- the windscreen is damaged or affected by foreign objects, e.g. stickers

Front pedestrian protection

Front pedestrian protection may help to avoid or reduce the harm caused by front-end crashes with pedestrians when driving forward.

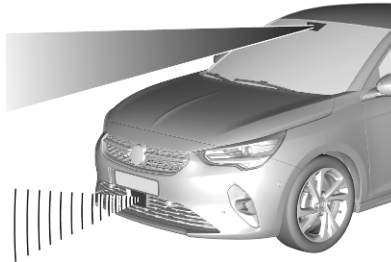

The system uses the front camera in the windscreen and depending on the vehicle configuration a radar unit in the front bumper to detect a pedestrian directly ahead in the path.

⚠ Warning

The usage of a license plate support may have an impact on the proper operation of the radar unit and may limit sensor performance. Vehicles or pedestrians driving or walking ahead may not be detected by the system.

Do not use a license plate support to ensure proper system functionality.

Front pedestrian protection can detect and alert to pedestrians in a forward gear at speeds between 5 km/h and 60 km/h. Additionally, front pedestrian protection can provide a boost to braking or automatically brake the vehicle.

During nighttime driving, system performance is limited.

⚠ Danger

Front pedestrian braking does not provide an alert or automatically brake the vehicle, unless it detects a pedestrian.

The system may not detect pedestrians, including children, when the pedestrian is not directly ahead, not fully visible, not standing upright, or when part of a group.

The system can only be deactivated by deactivating the active emergency braking in the vehicle personalisation ⇨ 77. When ignition is switched on next time, system is activated.

Front pedestrian alert

When approaching a detected pedestrian too quickly, a warning message is displayed in the Driver Information Centre. A warning chime is provided.

Cruise control or adaptive cruise control may be disengaged when the front pedestrian alert occurs.

System limitations

In the following cases, front pedestrian protection may not detect a pedestrian ahead or sensor performance is limited:

- vehicle speed is out of range from 5 km/h to 80 km/h in forward gear
- driving on winding or hilly roads
- driving in the dark
- weather limits visibility, such as fog, rain, or snow

- the sensor in the windscreen or the radar unit behind the front bumper are blocked by snow, ice, slush, mud, dirt etc.
- the windscreen is damaged or affected by foreign objects, e.g. stickers
- the front bumper is damaged or affected by foreign objects, e.g. license plate support

Parking assist

General information

When attaching a trailer or bicycle carrier to the trailer hitch, the parking assist is deactivated.

⚠ Warning

The driver bears full responsibility for the parking manoeuvre.

Always check the surrounding area when driving backwards or forwards while using parking assist system.

Rear parking assist

The system warns the driver with acoustic signals and display indication against potentially hazardous obstacles behind the vehicle while reverse gear is engaged.

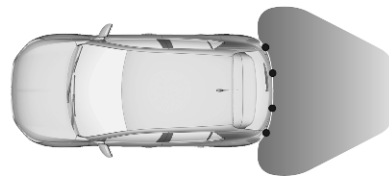

The system operates with ultrasonic parking sensors in the rear bumper.

Activation



The system is ready to operate when the LED in the parking assist button P_{OFF} is not illuminated. The state of the system is memorised when the ignition is switched off.

Once activated, rear parking assist is ready to operate when reverse gear is engaged and ignition is switched on.

Indication

Depending on which side of the vehicle is closer to an obstacle, you will hear acoustic warning signals in the vehicle on the respective side. The interval between the sounds

becomes shorter as the vehicle gets closer to that obstacle. When the distance is less than approx. 30 cm, the sound is continuous.

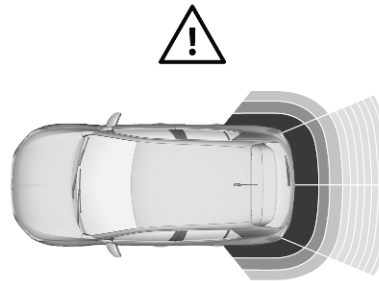

Additionally, the distance to rear obstacles is displayed by changing distance lines in the Info Display $\rightarrow 75$. When the obstacle is very close, \triangle for danger is displayed.

Deactivation



The system is switched off when reverse gear is disengaged. Press P_{OFF} to deactivate the system manually. The LED in the button illuminates when the system is deactivated. If the system has been deactivated manually, it is not reactivated automatically the next time the ignition is switched on.

Front-rear parking assist

The front-rear parking assist measures the distance between the vehicle and obstacles in front and

behind the vehicle. It informs and warns the driver by giving acoustic signals and display indication.

It uses two different acoustic warning signals for the front and rear monitoring areas, each with a different tone frequency.

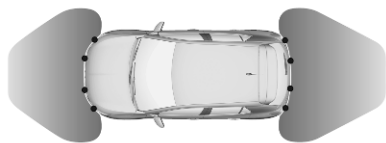

The system operates with ultrasonic parking sensors in the rear and front bumper.

Activation

In addition to the rear parking assist, the front parking assist is triggered when an obstacle is detected in front and the speed of the vehicle is below 10 km/h.



The system is ready to operate when the LED in the parking assist button $P \triangle$ OFF is not illuminated. The state of the system is memorised when the ignition is switched off.

Once activated, rear parking assist is ready to operate when reverse gear is engaged and ignition is switched on.

Indication

The system warns the driver with acoustic signals against potentially hazardous obstacles in front of the vehicle and behind the vehicle.

Depending on which side of the vehicle is closer to an obstacle, you will hear acoustic warning signals in the vehicle on the respective side. The interval between the sounds becomes shorter as the vehicle gets closer to that obstacle. When the distance is less than approx. 30 cm, the sound is continuous.

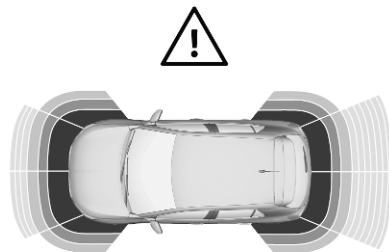

Additionally, the distance to rear and front obstacles is displayed by changing distance lines in the Info Display \rightarrow 75.

If the vehicle stops for more than 3 seconds in a forward gear, if automatic transmission is in **P**

position or if no further obstacles are detected, no acoustic warning signals are given.

Deactivation

The system is deactivated automatically when vehicle speed exceeds 10 km/h, by applying the electric parking brake or by pressing the parking assist button .

When the system is deactivated manually, the LED in the button illuminates.

If the system has been deactivated manually, it is not reactivated automatically the next time the ignition is switched on.

System limitations

In the event of a fault or if the system does not work temporarily, e.g. because of high external noise level or other interference factors,  illuminates in the instrument cluster. A message is displayed in the Driver Information Centre and a warning chime sounds.

Warning

Under certain circumstances, various reflective surfaces on objects or clothing as well as external noise sources may cause the system to fail to detect obstacles.

Special attention must be paid to low obstacles which can damage the lower part of the bumper.

Caution

Performance of the system can be reduced when sensors are covered, e.g. by ice or snow.

Performance of the parking assist system can be reduced due to heavy loading.

Special conditions apply if there are taller vehicles in the vicinity (e.g. off-road vehicles, mini vans, vans). Object identification and correct distance indication in the upper part of these vehicles cannot be guaranteed.

Objects with a very small reflection cross-section, e.g. objects of narrow size or soft materials, may not be detected by the system.

Parking assist systems do not detect objects outside the detection range.

Advanced parking assist

Warning

The driver bears full responsibility for accepting the parking slot suggested by the system and the parking manoeuvre.

Always check the surrounding area in all directions when using the advanced parking assist.

The advanced parking assist measures a suitable parking slot while passing, calculates the trajectory and automatically steers the vehicle while parking.

Advanced parking assist provides assistance for the following manoeuvres:

- entry into a parallel parking slot
- entry into a perpendicular parking slot
- exit from a parallel parking slot

The driver must control acceleration, braking and gear shifting, while steering is done automatically. The driver can take control at any time by gripping the steering wheel.

It may be necessary to move forwards and backwards more than once.

Instructions are given in the Info Display ↗ 75.

Advanced parking assist can only be activated when driving forwards.

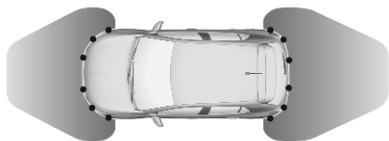

Advanced parking assist is always combined with front-rear parking assist.

The system has six ultrasonic parking sensors each in both the rear and front bumper.

Entry into a parallel parking slot

Activation

Slow down the vehicle speed below 30 km/h.

To search for a parking slot, activate the system in the Info Display ↗ 75.

Select the parallel parking slot menu.

Select parking side by switching on the turn light on the respective side.

The allowed parallel distance between the vehicle and a row of parked cars is between 0.5 m and 1.5 m.

The system will not identify slots that are clearly smaller or larger than the vehicle.

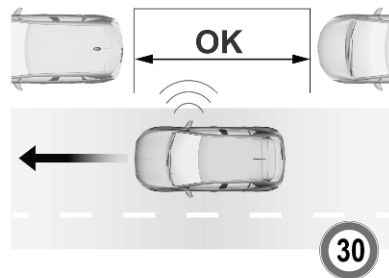

When a free slot is detected, a visual feedback on the Info Display and a first acoustic signal are given. Drive slowly forwards. When the second acoustic signal is given, stop the vehicle, select reverse gear, release the steering wheel and start moving slowly. A visual feedback is given on the Info Display.

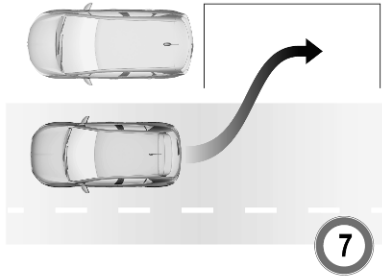

Move forwards and backwards while observing the warnings of the parking assist until the end of manoeuvre is indicated.

Entry into a perpendicular parking slot

Activation

Slow down the vehicle speed below 30 km/h.

To search for a parking slot, activate the system in the Info Display ⇨ 75.

Select the perpendicular parking slot menu.

Select parking side by switching on the turn light on the respective side.

The allowed parallel distance between the vehicle and a row of parked cars is between 0.5 m and 1.5 m.

When several successive slots are found, the vehicle will be directed towards the last one.

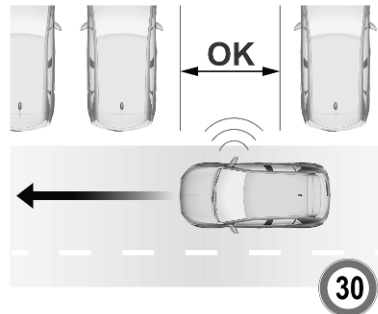

When a free slot is detected, a visual feedback on the Info Display and an acoustic signal are given. Stop the vehicle, select reverse gear, release the steering wheel and start moving without exceeding 7 km/h.

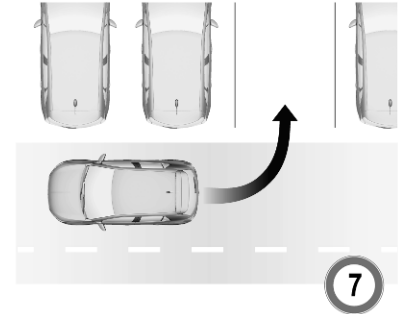

Move forwards and backwards as instructed by observing the warnings of the parking assist and paying attention to the acoustic signals until the end of manoeuvre is indicated.

During the parking manoeuvre, the system is automatically deactivated once the rear of the vehicle is within 50 cm of an obstacle.

Exiting a parallel parking slot

Activation

When exiting a parallel parking slot, activate the system in the Info Display ⇨ 75.

Select the exiting a parallel parking slot menu.

Select exit side by switching on the respective turn light.

Engage reverse or forward gear, release the steering wheel and start moving without exceeding 5 km/h.

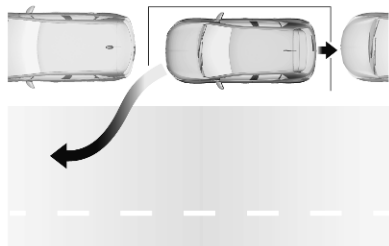

Move forwards and backwards while observing the warnings of the parking assist until the end of manoeuvre is indicated.

The manoeuvre is complete when the vehicle's front wheels are out of the parking slot.

After deactivation check control over the vehicle.

Display indication

The instructions on the display show:

- general hints and warning messages
- the demand to stop the vehicle, when a parking slot is detected
- the direction of driving during the parking manoeuvre
- the demand to shift into reverse or first gear
- the demand to stop or to drive slowly
- the successful completion of the parking manoeuvre indicated by a pop-up symbol and a chime
- the cancelling of a parking manoeuvre

Deactivation

The current park assist manoeuvre is cancelled via the button to return to the previous screen in the Info Display. To deactivate the system completely, press P_{OFF} in the centre console.

The system is deactivated automatically:

- if the ignition is switched off
- if stalling the engine
- if no manoeuvre is started within 5 minutes of selection of the type of manoeuvre
- after a prolonged stop of the vehicle during a manoeuvre
- activating the turn light on the opposite side to that of the manoeuvre
- if the electronic stability control is triggered
- if the speed of the vehicle exceeds the stated limit
- when the driver interrupts movement of the steering wheel
- after ten manoeuvres to enter or exit a parallel parking slot or after seven manoeuvres to enter a perpendicular parking slot
- by opening the driver's door
- if one of the front wheels encounters an obstacle
- parking manoeuvre successfully ended

Deactivation by the driver or by the system during manoeuvring will be indicated on the display. Additionally, a chime sounds.

The system is switched off automatically when towing an electrically connected trailer, bicycle carrier, etc.

Contact your dealer to switch off the system for a prolonged period.

Fault

In the event of a fault, a message is displayed in the Colour Info Display, accompanied by an acoustic signal.

In the event of a fault in the power steering,  illuminates and a message is displayed in the Driver Information Centre.

Warning

Under certain circumstances, various reflective surfaces on objects or clothing as well as external noise sources may cause the system to fail to detect obstacles.

Special attention must be paid to low obstacles which can damage the lower part of the bumper.

Caution

Performance of the system can be reduced when sensors are covered, e.g. by ice or snow.

Performance of the parking assist system can be reduced due to heavy loading.

Special conditions apply if there are taller vehicles in the vicinity (e.g. off-road vehicles, mini vans, vans). Object identification and correct distance indication in the upper part of these vehicles cannot be guaranteed.

Objects with a very small reflection cross-section, e.g. objects of narrow size or soft materials, may not be detected by the system.

Parking assist systems do not detect objects outside the detection range.

Note

It is possible that the sensor detects a non-existing object caused by echo disturbance from external acoustic noise or mechanical misalignments (sporadic false warnings may occur).

Make sure that the front number plate is properly mounted (not bent and no gaps to the bumper on the left or right side) and the sensors are firmly in place.

Advanced parking assist system may not respond to changes in the available parking space after initiating a parking manoeuvre. The system may recognize an entry, a gateway, a courtyard or even a crossing as a parking slot. After selecting reverse gear the system will start a parking manoeuvre. Take care regarding the availability of the suggested parking slot.

Surface irregularities, e.g. on construction zones, are not detected by the system. The driver accepts responsibility.

Side blind spot alert

Side blind zone alert assist helps to avoid crashes due to unintentional lane departures when an object is detected within a specified blind spot zone.

The system displays a visual alert in each exterior mirror, when detecting objects that may not be visible in the interior and exterior mirrors.

Side blind spot alert uses some of the advanced parking assist sensors which are located in the front and rear bumper on both sides of the vehicle.

Warning

Side blind zone assistant system is only a lane changing aid and does not replace driver vision.

Side blind zone assistant does not detect:

- Vehicles outside the side blind zones which may be rapidly approaching.
- Pedestrians or animals.

- Non-moving objects, e.g. stationary vehicles, street lights, road signs, etc.

Failure to use proper care when changing lanes may result in damage to the vehicle, injury, or death. Always check the outside and rearview mirrors, glance over your shoulder, and use the turn signal before changing lanes.

Activation

The system can be activated via the vehicle settings menu in the Info Display.

Info Display  75.

Functionality

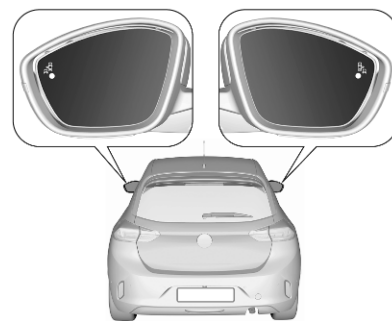

When the system detects a vehicle in the side blind zone while driving forwards, an LED will illuminate in the relevant exterior mirror.

The LED comes on immediately when your vehicle is being passed.

The LED comes on after a delay when your vehicle is passing another vehicle slowly.

Operation conditions

The following conditions must be fulfilled for proper operation:

- all vehicles are moving in the same direction and in adjacent lanes
- depending on the configuration of the vehicle, the speed of your vehicle is between 12 or 33 and 140 km/h
- passing a vehicle with a speed difference of less than 10 km/h
- another vehicle is passing with a speed difference of less than 25 km/h
- the traffic flow is normal
- driving on a straight or slightly curved road
- the vehicle is not pulling a trailer
- the sensors are not covered by mud, ice or snow
- the warning zones in the door mirrors or the detection zones on front and rear bumper are not covered with adhesive labels or other objects

No alert will be given in the following situations:

- in the presence of non-moving objects, e.g. parked vehicles, barriers, street lamps, road signs
- with vehicles moving in the opposite direction
- driving on a winding road or a sharp corner
- when passing or being passed by a very long vehicle, e.g. lorry, coach, which is at the same time detected at the rear in the blind spot angle and present in the driver's forward field of vision
- in very heavy traffic, vehicles detected in front and behind are confused with a lorry or a stationary object
- when passing too quickly

Deactivation

The system can be activated via the vehicle settings menu in the Info Display.

Info Display ↗ 75.

The state of the system is memorised when switching off the ignition.

The system is automatically deactivated when towing an electrically connected trailer.

Due to adverse weather conditions, such as heavy rain, false detections may occur.

Fault

In the event of a fault,  illuminates in the instrument panel, accompanied by a display message. Contact a dealer or a qualified workshop to have the system checked.

Active side blind spot detection

In addition to the regular side blind spot alert, the active side blind spot detection corrects the vehicle's trajectory by turning the steering wheel gently back into lane when an object is detected within a specified blind spot zone. The system is only active when side blind spot alert and lane keep assist are activated as well.

Lane keep assist ↗ 152.

Active side blind spot detection operates when the vehicle speed is between 65 and 140 km/h.

Functionality

When steering towards the detected vehicle is attempted, the driver will then notice a turning movement of the steering wheel towards the opposite side. Turn steering wheel in the same direction if the system does not steer sufficiently.

The system also intervenes even if the turn lights have been activated.

Panoramic view system

This system allows views of the vehicle's surroundings to be displayed as a nearly 180° picture in the Info Display, like a bird's eye view.

The system uses:

- rear camera, installed in the rear bumper
- ultrasonic parking sensors in the rear bumper

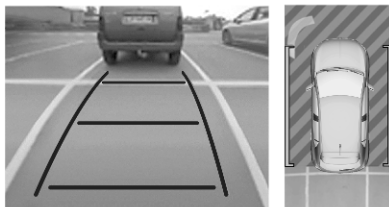

The screen in the Info display is divided into two parts. On the right there is a view from above the vehicle, and on the left there is the view from the rear displayed. The parking sensors complete the information on the view from above the vehicle.

Activation

The panoramic view system is activated by:

- engaging reverse gear
- driving up to 13 km/h

Functionality

Different views can be selected in the left part of the display. Change the type of view at any time during a manoeuvre by pressing the touch field in the left lower zone of the display and selecting a view from the view selection menu:

- Standard view
- Auto mode
- Zoom view
- 180° view

The display is immediately updated with the type of view selected.

Auto mode is activated by default. In this mode, the system selects the best view, standard or zoom, to display according to the information from the parking sensors.

The state of the system is not kept in memory when the ignition is switched off.

Standard view



The area behind the vehicle is displayed in the screen. The vertical lines represent the width of the vehicle with mirrors unfolded. The direction of the lines changes with the position of the steering wheel.

The first horizontal line represents a distance of about 30 cm beyond the edge of vehicle's rear bumper. The upper horizontal lines represent distances of about 1 m and 2 m.

This view is available in auto mode or in the view selection menu.

Auto mode

This mode is activated by default. Using sensors in the rear or in the front bumper, the automatic view changes from rear view or front view to a view from above, as an obstacle is approached during a manoeuvre.

Zoom view



The camera records the vehicle's surroundings during the manoeuvre in order to reconstruct a view from above the rear or the front of the vehicle in its near surroundings. Thus, the vehicle can be manoeuvred

around obstacles nearby. This view is available with auto mode or in the view selection menu.

180° view

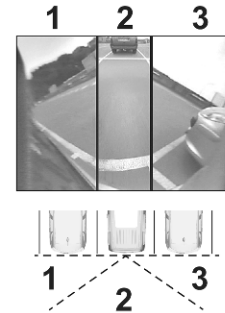

The 180° view facilitates reversing out of a parking bay, making it possible to see the approach of vehicles, pedestrians and cyclists. This view is not recommended for carrying out a complete manoeuvre. It is made up of three areas: left 1, centre 2 and right 3. This view is available from the view selection menu only.

Deactivation

Panoramic view system is deactivated when:

- towing an electrically connected trailer, bicycle carrier, etc.
- a certain forward speed is exceeded or if reverse gear is not engaged for 7 seconds
- by pressing the icon  in the left upper corner of the touch screen

General information

Warning

The panoramic view system does not replace driver vision. It will not display children, pedestrians, cyclists, crossing traffic, animals, or any other objects outside of the camera view area, e. g. below the bumper, or underneath the vehicle.

Do not drive or park the vehicle using only the panoramic view system.

Always check the surrounding of the vehicle before driving.

Displayed images may be further or closer than they appear. The area displayed is limited and objects that are close to either edge of the bumper or under the bumper are not displayed on the screen.

System limitations

Caution

For optimal operation of the system, it is important to keep the lense of the camera in the tailgate between the number plate lights and the lense in the front grill below the emblem always clean. Rinse the lenses with water and wipe with a soft cloth.

Do not clean the lenses with a steam-jet or high-pressure jet cleaner.

The panoramic view system may not operate properly when:

- The surrounding is dark.
- The sun or the beam of headlights is shining directly into the camera lenses.
- Weather limits visibility, such as fog, rain, or snow.
- The camera lenses are blocked by snow, ice, slush, mud, dirt.
- The vehicle had an accident.
- There are extreme temperature changes.

Rear view camera

The rear view camera assists the driver when reversing by displaying a view of the area behind the vehicle.

The view of the camera is displayed in the Info Display.

Warning

The rear view camera does not replace driver vision. Note that objects that are outside the

camera's field of view and the parking assist sensors, e.g. below the bumper or underneath the vehicle, are not displayed.

Do not reverse or park the vehicle using only the rear view camera.

Always check the surrounding of the vehicle before driving.

Switching on

Rear view camera is automatically activated when reverse gear is engaged.

Functionality

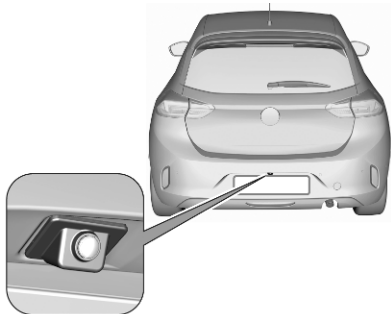

The camera is mounted in the rear bumper above the number plate.

The area displayed by the camera is limited. The distance of the image that appears on the display differs from the actual distance.

Guidelines

The first horizontal line represents a distance of about 30 cm beyond the edge of vehicle's rear bumper. The upper horizontal lines represent distances of about 1 m and 2 m.

Trajectory lane of the vehicle is shown in accordance with the steering angle.

Switching off

The camera is switched off when:

- towing an electrically connected trailer, bicycle carrier, etc.
- a certain forward speed is exceeded or if reverse gear is not engaged for 7 seconds
- by pressing the icon  in the left upper corner of the touch screen

System limitations

The rear view camera may not operate properly when:

- the surrounding is dark
- the beam of headlights is shining directly into the camera lenses
- weather limits visibility, such as fog, rain, or snow
- the camera lenses are blocked by snow, ice, slush, mud, dirt. Clean the lense, rinse with water, and wipe with a soft cloth
- the vehicle is towing an electrically connected trailer, bicycle carrier, etc.
- the vehicle had a rear end accident
- there are extreme temperature changes

Traffic sign assistant

The traffic sign assistant is an extension of the speed limit recognition available for speed limiter, cruise control and adaptive cruise control.



The system recognises the traffic signs above and displays them in the Driver Information Centre.

⚠ Warning

The actual traffic sign always takes priority over the traffic sign displayed in the Driver Information Centre.

If the vehicle enters a road of which the entry is prohibited, the no entry traffic symbol and a warning message are displayed in the Driver Information Centre. If the system detects one of the other traffic signs, the respective traffic sign is displayed in the Driver Information Centre.

Speed limiter ↗ 122

Cruise control ↗ 120

Adaptive cruise control ↗ 124

Lane keep assist

Lane keep assist supports the driver to avoid unintended leaving of the lane. The front camera observes road edges, as well as the lane markings between which the vehicle is driving. If the vehicle approaches a road edge or a lane marking, the steering wheel is gently turned to position so that the vehicle turns back into the lane. The driver will then notice a turning movement of the steering wheel. Turn steering wheel in same direction, if the system does not steer sufficiently. Turn steering wheel gently into opposite direction, if lane change is intended.

When the system steers to correct the trajectory of the vehicle,  flashes yellow in the instrument cluster.

Unintended lane departure is not assumed by the system when the turn lights are operated and during few seconds after turn lights have been switched off.

Note



The system may be switched off if it detects lanes which are too narrow, too wide or too curved.

Following preconditions have to be fulfilled:

- vehicle speed must be between 65 km/h and 180 km/h
- the driver must hold the steering wheel
- the turn lights are not activated
- the electronic stability control is activated and not in operation
- the vehicle is not connected to a trailer or an electric bicycle carrier
- normal driving behaviour (system detects dynamic driving style, i.e. pressure on the brake or accelerator pedal)
- roads with good lane markings
- no spare wheel is used
- the driver is not taking the hands off the steering wheel for a longer time period
- the vehicle is not driven in a tight corner

Activation



If the system is activated, the LED in the button  OFF is not illuminated. To activate the system when the system is deactivated, press  OFF.

The system is operational at vehicle speeds between 65 km/h and 180 km/h and if lane markings are detectable. The driver must hold the steering wheel. The electronic stability control system must be activated.

The control indicator  flashes yellow during trajectory correction.



If the driver wishes to maintain the trajectory of the vehicle, he can interrupt the correction by keeping a firm grip on the steering wheel, e.g. during an avoiding manoeuvre. The correction is interrupted if the turn lights are operated. If the vehicle is equipped with active side blind spot detection, the interruption of the lane correction might be cancelled.

Side blind zone assistant ⇨ 146.



There is no correction triggered when the turn lights are operated and during few seconds after turn lights have been switched off.

If the system detects that the driver is not holding the steering wheel permanently, it interrupts the correction. A warning message in the Driver Information Centre accompanied by a warning chime alerts the driver when immediate driver's action is required.

Deactivation

To deactivate the system, press and hold  OFF. Deactivation of the system is confirmed by the illuminated LED in the button and  illuminates yellow in the instrument cluster.

Fault

In the event of a fault,  and  appear in the instrument panel, accompanied by a display message and a warning chime. Contact a dealer or a qualified workshop to have the system checked.

System limitations

The system performance may be affected by:

- a dirty or foggy windscreen or if the windscreen is affected by foreign objects, e.g. stickers
- close vehicles ahead
- banked roads
- winding or hilly roads
- road edges
- sudden lighting changes

- adverse environmental conditions, e.g. heavy rain or snow
- vehicle modifications, e.g. tyres

Switch off the system if the system is disturbed by tar marks, shadows, road cracks, temporary or construction lane markings, or other road imperfections.

Warning

Always keep your attention on the road and maintain proper vehicle position within the lane, otherwise vehicle damage, injury or death could occur.

Lane keep assist does not continuously steer the vehicle.

The system may not keep the vehicle in the lane or give an alert, even if a lane marking is detected.

The steering of the lane keep assist may not be sufficient to avoid a lane departure.

The system may not detect hands-off driving due to external influences like road condition and surface and weather. The driver has full responsibility to control the vehicle and is always required to keep the hands on the steering wheel while driving.

Using the system while towing a trailer or on slippery roads could cause loss of control of the vehicle and a crash. Switch the system off.

Driver alert

The driver alert system monitors the driving time and the vigilance of the driver. Monitoring the vigilance of the driver is based on the trajectory variations of the vehicle compared to the lane markings.

The system includes a driving time alert combined with driver drowsiness detection.

Warning

The system cannot replace the need for vigilance on the part of the driver. Taking a break is recommended as soon as feeling tired or at least every 2 hours. Do not drive when feeling tired.

Activation or Deactivation

The system can be activated or deactivated in the vehicle personalisation  77.

The state of the system stays in memory when the ignition is switched off.

Driving time alert

The driver gets notified by a pop-up reminder symbol  in the Driver Information Centre simultaneously with an acoustic alert if the driver has not taken a break after 2 hours of driving at a speed above 65 km/h. The alert is repeated hourly until the vehicle is stopped, no matter how vehicle speed evolves.

The counting of driving time alert is reset when the ignition has been switched off for a few minutes.

Driver drowsiness detection

The system monitors the driver's level of vigilance at speeds above 65 km/h. A camera at the top of the windscreen detects variations in trajectory compared to the lane markings.

If the trajectory of the vehicle suggests a certain level of drowsiness or inattention by the driver, the system triggers the first level of alert. The driver is notified by a message and an audible signal is given.

After three first level alerts, the system triggers a new alert with a message, accompanied by a more pronounced audible signal.

In certain driving conditions (poor road surface or strong winds), the system may give alerts independent of the driver's level of vigilance.

The driver drowsiness detection is reinitialised when the ignition has been switched off for a few minutes or the speed remains below 65 km/h for a few minutes.

System limitations

In the following situations, the system may not operate properly or even not operate at all:

- poor visibility caused by inadequate lighting of the roadway, falling snow, heavy rain, dense fog etc.
- dazzle caused by headlamps of an oncoming vehicles, low sun, reflections on damp roads, leaving a tunnel, alternating shade and light etc.
- windscreen area in front of the camera covered by dirt, snow, stickers etc.
- no lane markings detected or multiple lane markings due to roadworks
- close vehicles ahead
- winding roads or narrow roads

Fuel

Fuel for petrol engines

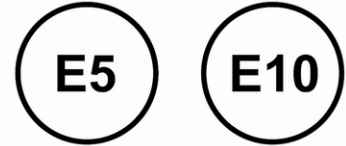

Only use unleaded fuel that complies with European standard EN 228 or E DIN 51626-1 or equivalent.

The engine is capable of running with fuel that contains up to 10% ethanol (e.g. named E10).

Use fuel with the recommended octane rating. A lower octane rating can reduce engine power and torque and slightly increases fuel consumption.

Caution

Do not use fuel or fuel additives that contain metallic compounds such as manganese-based additives. This may cause engine damage.

Caution

Use of fuel with a lower octane rating than the lowest possible rating could lead to uncontrolled combustion and engine damage.

The engine specific requirements regarding octane rating are given in the engine data overview ↗ 207. A country-specific label at the fuel filler flap can supersede the requirement. In certain countries, the use of a particular fuel, e.g. a specific octane rating, may be required to ensure proper engine operation.

Fuel for diesel engines

The Diesel engines are compatible with bio-fuels that conform to current and future European standards and can be obtained from filling stations:

B7

Diesel fuel that meets standard EN590 mixed with a biofuel that meets standard EN14214 (possibly containing up to 7% Fatty Acid Methyl Ester).

B10

Diesel fuel that meets standard EN16734 mixed with a biofuel that meets standard EN14214 (possibly containing up to 10% Fatty Acid Methyl Ester).

XTL

Paraffinic Diesel fuel that meets standard EN15940 mixed with a biofuel that meets standard EN14214 (possibly containing up to 7% Fatty Acid Methyl Ester).

B20**B30**

The use of B20 or B30 fuel meeting standard EN16709 is possible in your Diesel engines. However, this use, even occasional, requires strict

application of the special servicing conditions referred to as "Arduous conditions".

For more information, contact a dealer or a qualified workshop.

Caution

The use of any other type of (bio) fuel (vegetable or animal oils, pure or diluted, domestic fuel etc.) is strictly prohibited (risk of damage to the engine and fuel system).

Note

The only Diesel additives authorised for use are those that meet the B715000 standard.

Low temperature operation

At temperatures below 0 °C, some diesel products with biodiesel blends may clog, freeze or gel, which may affect the fuel supply system. Starting and engine operation may not work properly. Make sure to fill winter grade diesel fuel at ambient temperatures below 0 °C.

Arctic grade diesel fuel can be used in extreme cold temperatures below -20 °C. Using this fuel grade in warm or hot climates is not recommended and may cause engine stalling, poor starting or damage on the fuel injection system.

Refuelling

⚠ Danger

Before refuelling, switch off ignition and any external heaters with combustion chambers.

Follow the operating and safety instructions of the filling station when refuelling.

⚠ Danger

Fuel is flammable and explosive. No smoking. No naked flames or sparks.

If you can smell fuel in your vehicle, have the cause of this remedied immediately by a workshop.

A label with symbols at the fuel filler flap is indicating the allowed fuel types. In Europe the pump nozzles of the filling stations are marked with these symbols. Refuel only the allowed fuel type.

Caution

In case of misfuelling, do not switch on ignition.

Fuel filler flap is located at right rear side of vehicle.



The fuel filler flap can only be opened if the vehicle is unlocked. Release the fuel filler flap by pushing the flap.

Petrol and diesel refuelling

To open, turn the cap slowly anticlockwise.

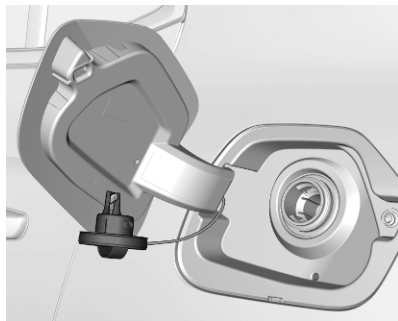

The fuel filler cap can be attached to the hook on the fuel filler flap.

Place the nozzle in straight position to the filler neck and press with slight force to insert.

To refuel, switch on pump nozzle.

After the automatic cut-off, the tank can be topped up by operating the pump nozzle a maximum of two more times.

Caution

Wipe off any overflowing fuel immediately.

To close, turn the fuel filler cap clockwise until it clicks.

Close the flap and allow it to engage.

Fuel filler cap

Only use genuine fuel filler caps.

Diesel-engined vehicles have special fuel filler caps.

Trailer hitch

General information

Only use towing equipment that has been approved for your vehicle.

Entrust retrofitting of towing equipment to a workshop. It may be necessary to make changes that affect the cooling system, heat shields or other equipment.

The bulb outage detection function for trailer brake light cannot detect a partial bulb outage. E.g. in case of four bulbs with a power of 5 W each, the function only detects lamp outage when only a single 5 W lamp remains or none remain.

Trailers equipped with LED lights are not suitable for the wiring harness of this trailer hitch.

Fitting of towing equipment could cover the opening of the towing eye. If this is the case, use the coupling ball bar for towing. Always keep the coupling ball bar in the vehicle to have it on hand if needed.

Driving characteristics and towing tips

Before attaching a trailer, lubricate the coupling ball. However, do not do so if a stabiliser, which acts on the coupling ball, is being used to reduce snaking movements.

During trailer towing do not exceed a speed of 80 km/h. A maximum speed of 100 km/h is only appropriate if an oscillation damper is used and the permissible gross trailer weight does not exceed the vehicle's curb weight.

For trailers with low driving stability and caravan trailers, the use of an oscillation damper is strongly recommended.

If the trailer starts snaking, drive more slowly, do not attempt to correct the steering and brake sharply if necessary.

When driving downhill, drive in the same gear as if driving uphill and drive at a similar speed.

Adjust tyre pressure to the value specified for full load ⇨ 210.

Trailer towing

Trailer loads

The permissible trailer loads are vehicle and engine-dependent maximum values which must not be exceeded. The actual trailer load is the difference between the actual gross weight of the trailer and the actual coupling socket load with the trailer coupled.

The permissible trailer loads are specified in the vehicle documents. In general, they are valid for gradients up to 12%.

The permissible trailer load applies up to the specified incline and at sea level. Since engine power decreases as altitude increases due to the air becoming thinner, therefore reducing climbing ability, the permissible gross train weight also decreases by 10% for every 1000 m of altitude. The gross train weight does not have to be reduced when driving on roads with slight inclines (less than 8%, e.g. motorways).

The permissible gross train weight must not be exceeded. This weight is specified on the identification plate ⇨ 203.

Vertical coupling load

The vertical coupling load is the load exerted by the trailer on the coupling ball. It can be varied by changing the weight distribution when loading the trailer.

The maximum permissible vertical coupling load (55 kg) is specified on the towing equipment identification plate and in the vehicle documents.

Always aim for the maximum vertical coupling load, especially in the case of heavy trailers. The vertical coupling load should never fall below 25 kg.

Rear axle load

When the trailer is coupled and the towing vehicle fully loaded, the permissible rear axle load (see identification plate or vehicle documents) may be exceeded by 60 kg, the gross vehicle weight rating must not be exceeded. If the permissible rear axle load is exceeded, a maximum speed of 100 km/h applies.

Vehicle care

General Information	161
Accessories and vehicle modifications	161
Vehicle storage	162
End-of-life vehicle recovery	162
Vehicle checks	163
Performing work	163
Bonnet	163
Engine oil	164
Engine coolant	165
Washer fluid	165
Brakes	166
Brake fluid	166
Vehicle battery	166
Diesel fuel system bleeding	168
Wiper blade replacement	168
Bulb replacement	169
Halogen headlights	169
LED headlights	171
Front fog lights	171
Front turn lights	171
Tail lights	172
Number plate light	174
Interior lights	174

Electrical system	174
Fuses	174
Engine compartment fuse box	175
Instrument panel fuse box	176
Vehicle tools	178
Tools	178
Wheels and tyres	179
Winter tyres	179
Tyre designations	179
Tyre pressure	179
Tyre deflation detection system	180
Tread depth	181
Changing tyre and wheel size	182
Wheel covers	182
Tyre chains	182
Tyre repair kit	183
Wheel changing	186
Spare wheel	187
Jump starting	191
Towing	192
Towing the vehicle	192
Towing another vehicle	193
Appearance care	194
Exterior care	194
Interior care	196
Floor mats	196

General Information

Accessories and vehicle modifications

We recommend the use of genuine parts and accessories and factory approved parts specific for your vehicle type. We cannot assess or guarantee reliability of other products - even if they have a regulatory or otherwise granted approval.

Any modification, conversion or other changes made to standard vehicle specifications (including, without limitation, software modifications, modifications of the electronic control units) may invalidate the warranty offered by Opel. Furthermore, such changes may affect driver assistance systems, may impact fuel consumption, CO₂ emissions and other emissions of the vehicle and cause the vehicle to no longer conform to the operating permit, impacting the validity of your vehicle registration.

Caution
When transporting the vehicle on a train or on a recovery vehicle, the mud flaps might be damaged.

Vehicle storage

Storage for a long period of time

If the vehicle is to be stored for several months:

- Wash and wax the vehicle.
- Have the wax in the engine compartment and underbody checked.
- Clean and preserve the rubber seals.
- Fill up fuel tank completely.
- Change the engine oil.
- Drain the washer fluid reservoir.
- Check the coolant antifreeze and corrosion protection.
- Adjust tyre pressure to the value specified for full load.

- Park the vehicle in a dry, well ventilated place. Engage first or reverse gear or set selector lever to **P**. Prevent the vehicle from rolling.
- Do not apply the parking brake.
- Open the bonnet, close all doors and lock the vehicle.
- Disconnect the clamp from the negative terminal of the vehicle battery. Note that all systems are not functional, e.g. anti-theft alarm system.

Putting back into operation

When the vehicle is to be put back into operation:

- Connect the clamp to the negative terminal of the vehicle battery. Initialise the power windows ⇨ 23.
- Check tyre pressure.
- Fill up the washer fluid reservoir.
- Check the engine oil level.
- Check the coolant level.
- Fit the number plate if necessary.

End-of-life vehicle recovery

Information on end-of-life vehicle recovery centres and the recycling of end-of-life vehicles is available on our website, where legally required. Only entrust this work to an authorised recycling centre.

Vehicle checks

Performing work

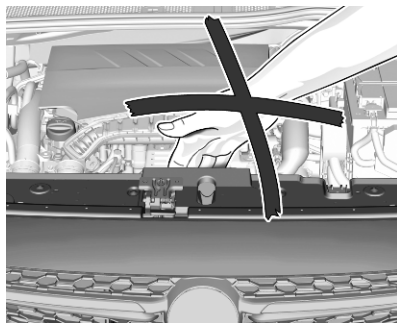

⚠ Warning

Only perform engine compartment checks when the ignition is off.
The cooling fan may start operating even if the ignition is off.

⚠ Danger

The ignition system uses extremely high voltage. Do not touch.

Bonnet

Opening

Open the driver's door.

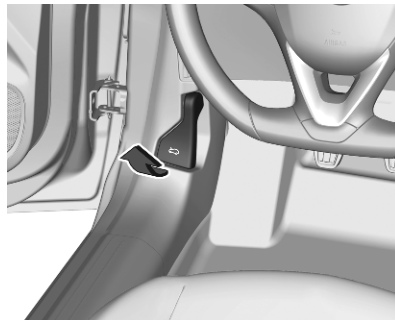

Pull the release lever and return it to its original position.

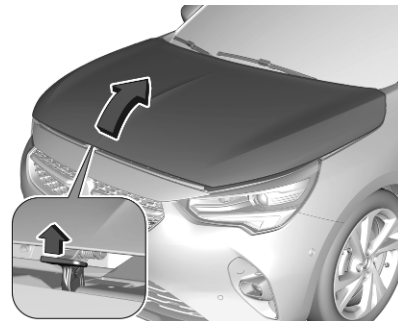

Push the safety catch upwards and open the bonnet.

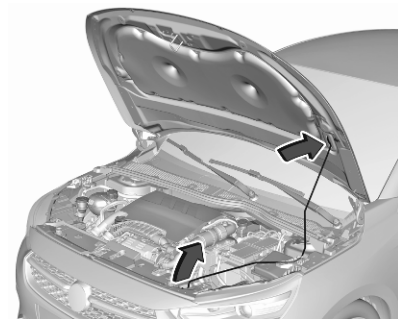

Secure the bonnet support.

Closing

Before closing the bonnet, press the support into the holder.

Lower the bonnet and let it fall into the latch from a low height (20-25 cm). Check that the bonnet is engaged.

Caution

Do not press the bonnet into the latch to avoid dents.

Engine oil

Check the engine oil level manually on a regular basis to prevent damage to the engine. Ensure that the correct specification of oil is used.

Recommended fluids and lubricants
 ⇨ 201.

The maximum engine oil consumption is 0.6 l per 1000 km.

Check with the vehicle on a level surface. The engine must be at operating temperature and switched off for at least 5 min.

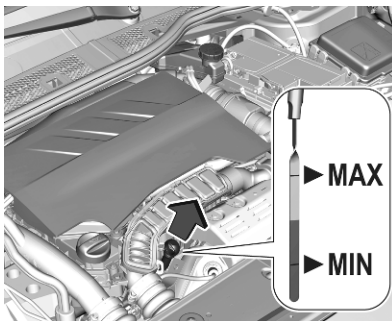

Different dipsticks are used depending on engine variant.

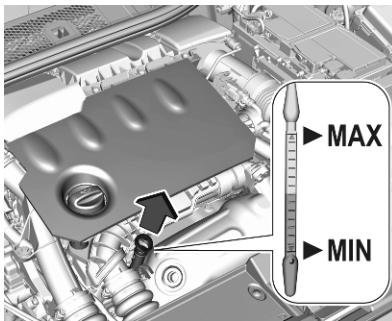

Pull out the dipstick, wipe it clean, reinsert it fully, pull out and read the engine oil level.

When the engine oil level has dropped to the **MIN** mark, top up the engine oil.

We recommend the use of the same grade of engine oil that was used at last change.

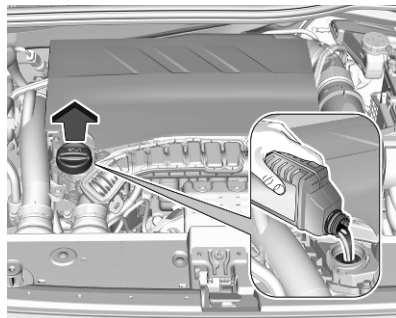

The engine oil level must not exceed the **MAX** mark on the dipstick.

Caution

Overfilled engine oil must be drained or suctioned out. If the oil exceeds the maximum level, do not start the vehicle and contact a workshop.

Capacities ⇨ 209.

Fit the cap on straight and tighten it.

Engine coolant

The factory filled coolant provides freeze protection down to approx. -37 °C.

Caution

Only use approved antifreeze.

Coolant and antifreeze ⇨ 201.

Coolant level**Caution**

Too low a coolant level can cause engine damage.

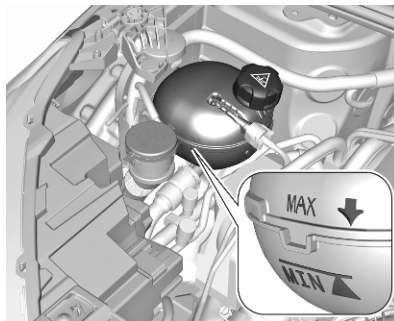

If the cooling system is cold, the coolant level should be above the **MIN** mark. Top up if the level is low.

⚠ Warning

Allow the engine to cool before opening the cap. Carefully open the cap, relieving the pressure slowly.

To top up, use a 1:1 mixture of released coolant concentrate mixed with clean tap water. If no coolant concentrate is available, use clean tap water. Install the cap tightly. Have

the coolant concentration checked and have the cause of the coolant loss remedied by a workshop.

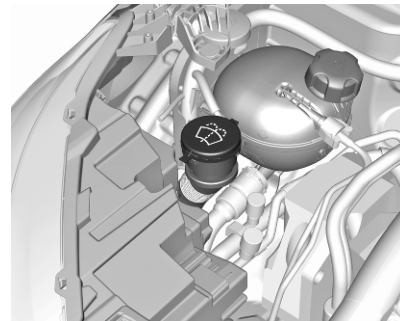
Washer fluid

Fill with clean water mixed with a suitable quantity of approved windscreen washer fluid which contains antifreeze.

Caution

Only washer fluid with a sufficient antifreeze concentration provides protection at low temperatures or a sudden drop in temperature.

Washer fluid ↗ 201.

Brakes

In the event of minimum thickness of the brake lining, a squealing noise sounds during braking.

Continued driving is possible but have the brake lining replaced as soon as possible.

Once new brake linings are installed, do not brake unnecessarily hard for the first few journeys.

Brake fluid**⚠ Warning**

Brake fluid is poisonous and corrosive. Avoid contact with eyes, skin, fabrics and painted surfaces.

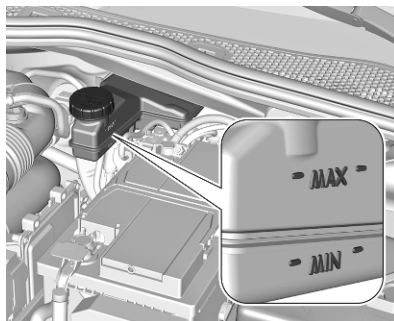

The brake fluid level must be between the **MIN** and **MAX** marks.

If fluid level is below **MIN** seek the assistance of a workshop.

Brake and clutch fluid ↗ 201.

Vehicle battery

The vehicle battery is maintenance-free provided that the driving profile allows sufficient charging of the battery. Short-distance-driving and frequent engine starts can discharge the battery. Avoid the use of unnecessary electrical consumers.



Batteries do not belong in household waste. They must be disposed of at an appropriate recycling collection point.

Laying up the vehicle for more than four weeks can lead to battery discharge. Disconnect the clamp from the negative terminal of the vehicle battery.

Ensure the ignition is switched off before connecting or disconnecting the vehicle battery.

Battery discharge protection ↗ 88.

Replacing the vehicle battery**Note**

Any deviation from the instructions given in this section may lead to temporary deactivation or disturbance of the stop-start system.

When the vehicle battery is being replaced, please ensure that there are no open ventilation holes in the vicinity of the positive terminal. If a ventilation hole is open in this area, it must be closed off with a dummy cap, and the ventilation in the vicinity of the negative terminal must be opened.

Ensure that the battery is always replaced by the same type of battery.

The vehicle battery has to be replaced by a workshop.

Stop-start system ⇨ 103.

Charging the vehicle battery

Warning

On vehicles with stop-start system, ensure that the charging potential does not exceed 14.6 V when using a battery charger. Otherwise the vehicle battery may be damaged.

Jump starting ⇨ 191.

Discharge protection

Battery voltage

When the vehicle battery voltage is running low, a warning message will appear in the Driver Information Centre.

When the vehicle is being driven, the load reduction function temporarily deactivates certain functions, such as the air conditioning, the heated rear window, heated steering wheel, etc.

The deactivated functions are reactivated automatically as soon as conditions permit.

Idle boost

If charging of the vehicle battery is required due to battery condition, the power output of the generator must be increased. This will be achieved by an idle boost which may be audible.

A message appears in the Driver Information Centre.

Power outlet

The power outlets are deactivated in the event of low vehicle battery voltage.

Warning label



Meaning of symbols:

- No sparks, naked flames or smoking.
- Always shield eyes. Explosive gases can cause blindness or injury.
- The vehicle battery contains sulphuric acid which could cause blindness or serious burn injuries.
- Keep the vehicle battery out of reach of children.

- See the Owner's Manual for further information.
- Explosive gas may be present in the vicinity of the vehicle battery.

Power saving mode

This mode deactivates electrical consumers to avoid excessive discharging of the vehicle battery. These consumers, such as the Infotainment system, windscreen wipers, low beam headlights, courtesy light, etc. can be used for a total maximum time of about 40 minutes after ignition is switched off.

Changing into power saving mode

When power saving mode is activated, a message appears in the Driver Information Centre.

An active telephone call using the hands-free option will be maintained for around 10 minutes longer.

Deactivating power saving mode

Power saving mode is deactivated automatically when the engine is restarted. Run the engine for a sufficient charge:

- for less than 10 minutes to use the consumers for approx. 5 minutes
- for more than 10 minutes to use the consumers for up to approx. 30 minutes

Heating functionalities

Note

Individual heating functionalities, such as heated seats or heated steering wheel, may be temporarily unavailable in the event of electrical loading constraints. Functions will be resumed after some minutes.

Diesel fuel system bleeding

If the tank has been run dry, the diesel fuel system must be bled. Refuel at least five liters diesel. Switch on the ignition for about 60 seconds and switch off again. Then crank the engine. If the engine does not start directly, repeat this process a few times. If the engine then fails to start, seek the assistance of a workshop.

Wiper blade replacement

Windscreen

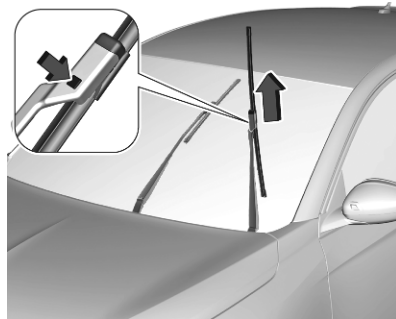

Switch off ignition.

Within one minute after switching off ignition, operate the wiper lever to position the wiper blades vertically on the windscreen.

Lift the wiper arm until it stays in the raised position, press button to disengage the wiper blade and remove.

Attach the new wiper blade to the wiper arm and push until it engages.

Lower wiper arm carefully.

To return the wiper arms to their original position, switch on the ignition and operate the wiper lever.

Rear window

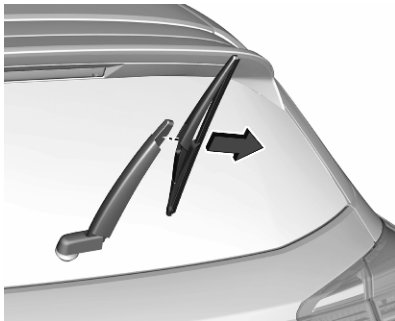

Lift wiper arm. Disengage wiper blade as shown in illustration and remove.

Attach the wiper blade slightly angled to the wiper arm and push until it engages.

Lower wiper arm carefully.

Bulb replacement

Before replacing a bulb, ensure that all exterior and interior lights and the ignition are switched off.

Only hold a new bulb at the base. Do not touch the bulb glass with bare hands.

Use only the same bulb type for replacement.

Replace headlight bulbs from within the engine compartment.

Bulb check

After a bulb replacement switch on the ignition, operate and check the lights.

Halogen headlights

Halogen headlights with separate bulbs for low beam and high beam / daytime running light.

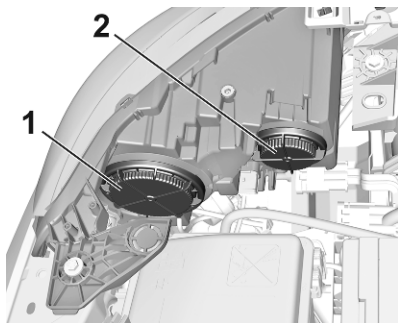

Low beam (1) outer bulb.

High beam / daytime running light (2) inner bulb.

Low beam (1)

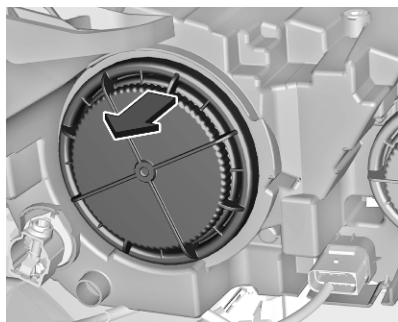

1. Remove the protective cover by pulling.

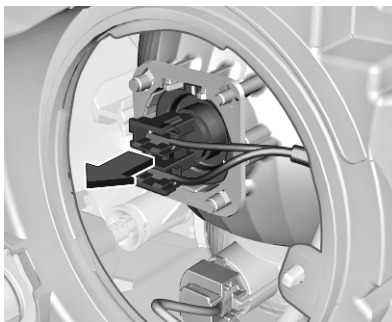

2. Withdraw the bulb socket from the reflector housing.

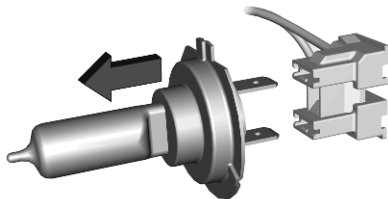

3. Detach the bulb from the bulb socket and replace the bulb.

4. Insert the bulb socket into the reflector housing.

5. Fit the protective cover on.

High beam / daytime running light (2)

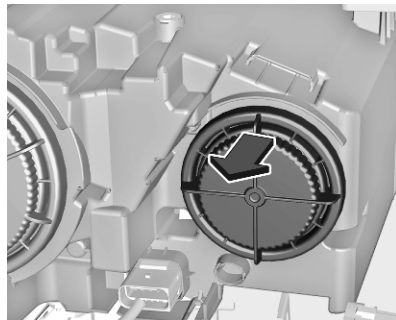

1. Remove the protective cover by pulling.

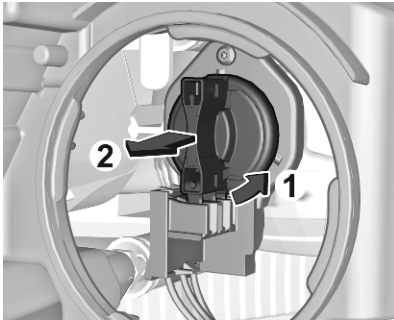

2. Rotate the bulb socket anticlockwise to disengage and withdraw from the reflector.
3. Insert the new bulb socket into the reflector housing.
4. Fit the protective cover on.

LED headlights

Headlights for low and high beam, daytime running lights and turn lights are designed as LEDs and cannot be changed.

Have lights repaired by a workshop in case of failure.

Front fog lights

Have lights repaired by a workshop in case of failure.

Front turn lights

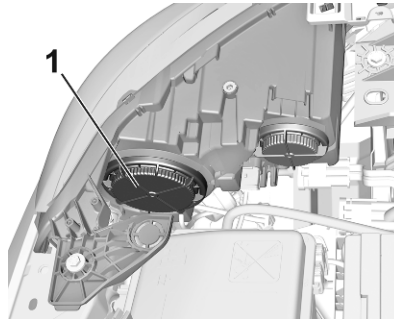

Turn light (1) outer bulb.

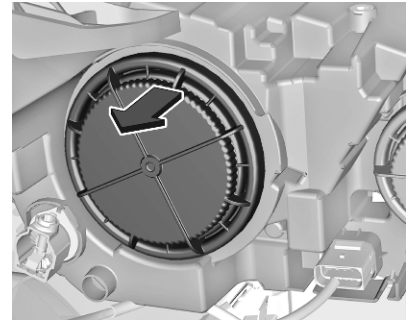

1. Remove the protective cover by pulling.

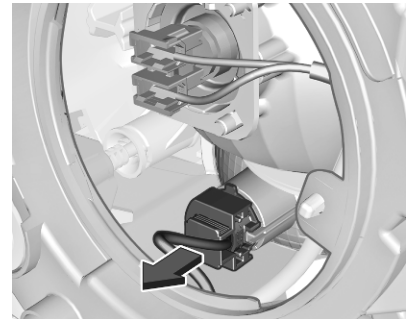

2. Withdraw the bulb socket from the reflector housing.

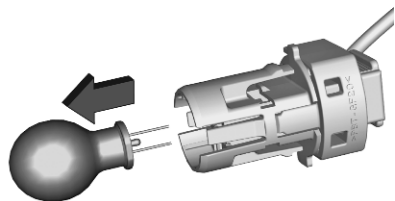

3. Detach the bulb from the bulb socket and replace the bulb.
4. Insert the bulb socket into the reflector housing.
5. Fit the protective cover on.

Tail lights

LED tail lights

Have lights repaired by a workshop in case of failure.

Light assembly in the body



1. Open the tailgate then remove the access cover on the relevant side.

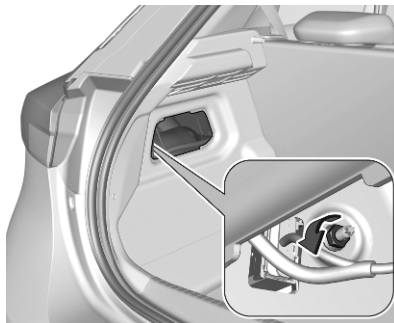

2. Slacken the lamp fixing nut using a box spanner or socket.

To avoid losing the nut if it drops into the wing trim, first place a cloth below it.

3. Manually unscrew and remove the lamp fixing nut.

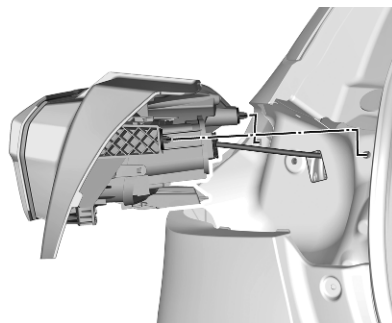

4. Carefully withdraw tail light assembly from the recess and remove.
5. Detach the cable from the retainer.

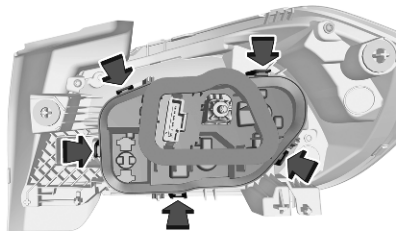

6. Press the five retaining lugs and remove the bulb carrier from the light assembly.

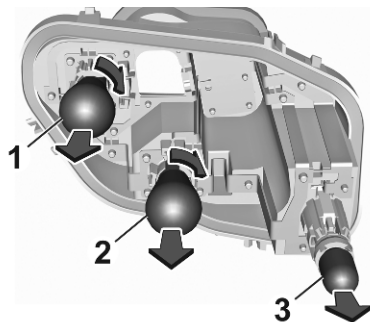

7. Remove and replace the bulbs:
Tail light / brake light (1)
Turn light (2)
Reverse light (3)
8. Insert the bulb carrier into the light assembly. Attach plug to the light assembly. Fit the light assembly in the recess and tighten the lamp fixing nut from the inside. Attach the cover.

Rear fog light

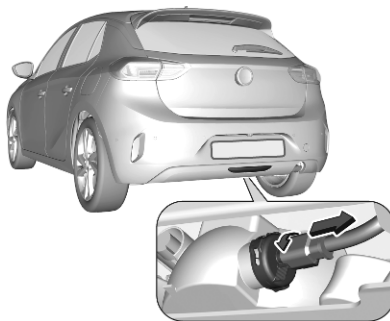

1. Turn the bulb holder anticlockwise and remove it from the reflector housing.

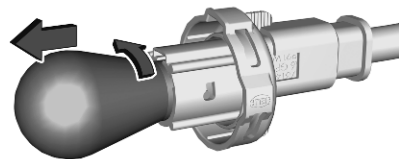

2. Slightly press down the bulb, turn it anticlockwise and remove it from the socket.
3. Replace and insert the new bulb into socket by turning clockwise.
4. Insert the bulb socket into the reflector and turn clockwise.

Centre high-mounted brake light

Have lights repaired by a workshop in case of failure.

Bulb check

Switch on the ignition, operate and check all lights.

Number plate light

Have lights repaired by a workshop in case of failure.

Interior lights

Have the following bulbs replaced by a workshop:

- courtesy light, reading lights
- load compartment light
- instrument panel illumination

Electrical system

Fuses

Data on the replacement fuse must match the data on the defective fuse.

The three fuse boxes are located in:

- engine compartment
- instrument panel

Before replacing a fuse, turn off the respective switch and the ignition.

A blown fuse can be recognised by its melted wire.

Caution
Do not replace the fuse until the cause of the fault has been remedied.

Some functions are protected by several fuses.

Fuses may also be inserted without existence of a function.

Fuse extractor

A fuse extractor may be located in the cover of the left side of the instrument panel. The extractor has two sides, each side is designed for a different type of fuses.

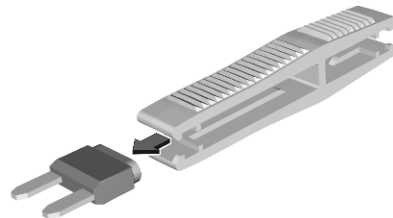

Grab the fuse with the fuse extractor and withdraw the fuse.

Engine compartment fuse box

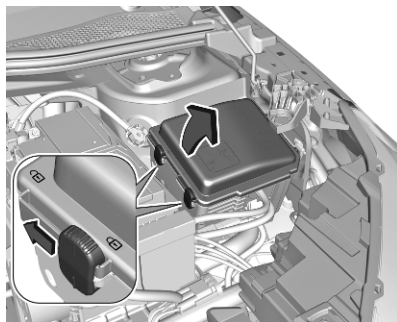

The fuse box is in the front left of the engine compartment. Disengage the cover and remove it.

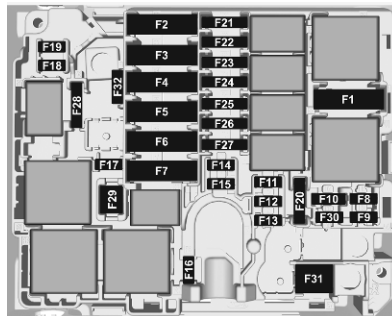

No. Circuit

- 1 Climate control system
- 2 Brake system
- 3 Fuse box (right side of the instrument panel)
- 4 Brake system
- 8 Fuel pump
- 16 Right headlight / heated wind-screen
- 18 Right high beam
- 19 Left high beam

No. Circuit

- 20 Fuel pump
- 22 Automatic transmission
- 25 Fuse box (trailer)
- 28 Selective catalytic reduction system
- 29 Windscreen wiper
- 31 Climate control system
- 32 Steering wheel

After having changed defective fuses, close the fuse box cover and lock it. If the fuse box cover is not closed correctly, malfunction may occur.

Instrument panel fuse box

Fuse box on the left side of the instrument panel



In left-hand drive vehicles, the fuse box is behind a cover in the instrument panel. Disengage cover at the bottom side and remove.



In right-hand drive vehicles, the fuse box is located behind a cover in the glovebox. Open the glovebox and remove the cover.

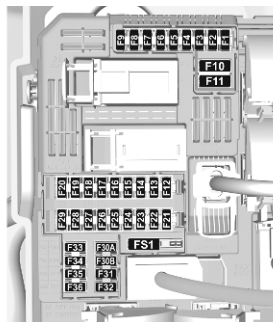

No. Circuit

- | | |
|----|------------------------------------------|
| 1 | Radar / Interior mirror |
| 3 | Inductive charging |
| 4 | Horn |
| 5 | Windscreen washer |
| 6 | Windscreen washer |
| 7 | USB |
| 8 | Rear wiper |
| 10 | Central locking system |
| 11 | Central locking system |
| 12 | Diagnostic connector module |
| 13 | Climate control system |
| 14 | Alarm / Opel Connect |
| 17 | Instrument cluster |
| 21 | Power button / Anti-theft locking system |
| 22 | Rain sensor / Light sensor / Camera |
| 23 | Seatbelt reminder |

No. Circuit

- 24 7" Touchscreen / Parking assist / Rear view camera
- 25 Airbag
- 27 Anti-theft alarm system
- 29 7" Touchscreen / Infotainment
- 31 Cigarette lighter / 12 V power outlet
- 32 Heated steering wheel
- 33 Climate control system / Automatic transmission
- 34 Parking assist / Exterior mirror adjustment

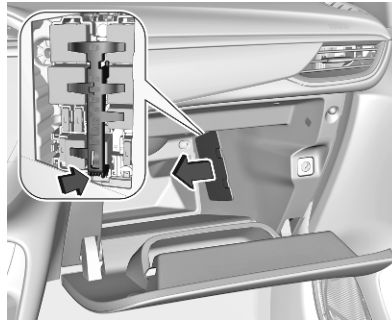
Fuse box on the right side of the instrument panel

In left-hand drive vehicles, the fuse box is located behind a cover in the glovebox. Open the glovebox and remove the cover. Remove the bracket.

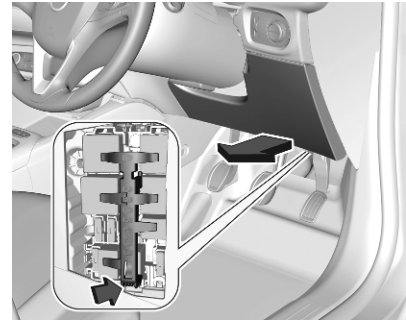

In right-hand drive vehicles, the fuse box is located behind a cover in the instrument panel. Disengage cover at the bottom side and remove. Remove the bracket.

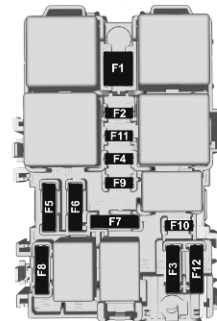

No. Circuit

- 1 Heated rear window
- 2 Heated exterior mirrors
- 3 Power windows front
- 4 Exterior mirror adjustment / Folding mirrors
- 5 Power windows rear
- 8 Fuse box (right side of the instrument panel)
- 10 Heated front seats
- 11 Seat massage function

Vehicle tools

Tools

Vehicles with spare wheel

Open the load compartment.

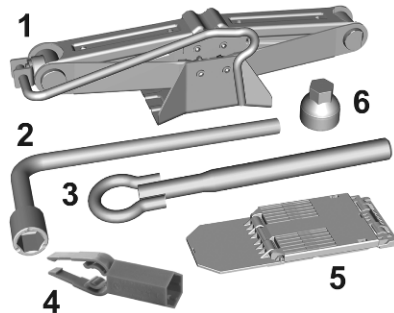

The tools are located in the tool bag:

- Jack (1)
- Wheel wrench (2)
- Towing eye (3)
- Wheel bolt cover remover (4)
- Chock (5)
- Adapter for the locking wheel nuts (6)

Vehicles without spare wheel

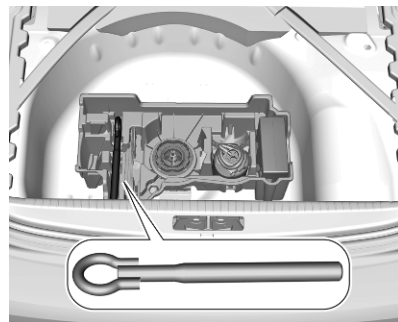

The towing eye is located in a box below the floor cover in the load compartment.

Tyre repair kit ↗ 183.

Wheels and tyres

Tyre condition, wheel condition

Drive over edges slowly and at right angles if possible. Driving over sharp edges can cause tyre and wheel damage. Do not trap tyres on the kerb when parking.

Regularly check the wheels for damage. Seek the assistance of a workshop in the event of damage or unusual wear.

Winter tyres

Winter tyres improve driving safety at temperatures below 7 °C and should therefore be fitted on all wheels.

In accordance with country-specific regulations, affix the speed sticker in the driver's field of view.

All tyre sizes are permitted as winter tyres ⇨ 210.

Tyre designations

E.g. **225/55 R 18 98 V**

- 225** : tyre width, mm
- 55** : cross-section ratio (tyre height to tyre width), %
- R** : belt type: Radial
- RF** : type: RunFlat
- 18** : wheel diameter, inches
- 98** : load index e.g. 98 is equivalent to 750 kg
- V** : speed code letter

Speed code letter:

- Q** : up to 160 km/h
- S** : up to 180 km/h
- T** : up to 190 km/h
- H** : up to 210 km/h
- V** : up to 240 km/h
- W** : up to 270 km/h

Choose a tyre appropriate for the maximum speed of your vehicle.

The maximum speed is achievable at kerb weight with driver (75 kg) plus 125 kg payload. Optional equipment could reduce the maximum speed of the vehicle.

Performance ⇨ 207.

Directional tyres

Directional tyres should be mounted so that they rotate in the correct direction. The proper rotation direction is indicated by a symbol (e.g. an arrow) on the sidewall.

Tyre pressure

Check the pressure of cold tyres at least every 14 days and before any long journey. Do not forget the spare wheel. This also applies to vehicles with tyre deflation detection system.



Tyre pressure ⇨ 210.

The tyre pressure information label on the right door frame indicates the original equipment tyres and the correspondent tyre pressures.

The tyre pressure data refers to cold tyres. It applies to summer and winter tyres.

Always inflate the spare tyre to the pressure specified for full load.

Incorrect tyre pressures will impair safety, vehicle handling, comfort and fuel economy and will increase tyre wear.

Tyre pressures differ depending on various options. For the correct tyre pressure value, follow the procedure below:

1. Identify the engine identifier code.
Engine data ↗ 207.
2. Identify the respective tyre.

The tyre pressure tables show all possible tyre combinations ↗ 210.

For the tyres approved for your vehicle, refer to the EEC Certificate of Conformity provided with your vehicle or other national registration documents.

The driver is responsible for correct adjustment of tyre pressure.

Warning

If the pressure is too low, this can result in considerable tyre warm-up and internal damage, leading to tread separation and even to tyre blow-out at high speeds.

Warning

For specific tyres the recommended tyre pressure as shown in the tyre pressure table may exceed the maximum tyre pressure as indicated on the tyre. Never exceed the maximum tyre pressure as indicated on the tyre.

Temperature dependency

The tyre pressure depends on the temperature of the tyre. During driving, tyre temperature and pressure increase. Tyre pressure values provided on the tyre

information label and tyre pressure chart are valid for cold tyres, which means at 20 °C.

The pressure increases by nearly 10 kPa for a 10 °C temperature increase. This must be considered when warm tyres are checked.

Tyre deflation detection system

The tyre deflation detection system continually checks the rotation speed of all four wheels and warns on low tyre pressure condition once vehicle is driving. This is achieved by comparing tyre rolling circumference with reference values and further signals.

If a tyre loses pressure the control indicator  illuminates and a warning message is displayed in the Driver Information Centre.

Control indicator  ↗ 71.

In this case reduce speed, avoid sharp cornering and strong braking. Stop at next safe opportunity and check tyre pressure.

After adjusting tyre pressure initialise system to extinguish the control indicator and restart system.

If the failure continues to be displayed, contact a workshop. The system is inoperable when ABS or ESC has a malfunction or a temporary spare wheel is used. Once the tyre has been refitted, check the tyre pressure with cold tyres and initialise the system.

Caution

Deflation detection system warns just about low tyre pressure condition and does not replace regular tyre maintenance by the driver.

System initialisation

After tyre pressure correction or wheel change, the system must be initialised to learn new circumference reference values:

1. Always ensure that all four tyres have correct tyre pressure
↻ 210.
2. Apply parking brake.
3. Initialise the system via the Info Display ↻ 75.
4. Reset is confirmed by pop-up indication.

After initialisation system automatically calibrates to new tyre pressures during driving. After longer drive the system will adopt and monitor new pressures.

Always check tyre pressure with cold tyres.

System has to be reinitialised when:

- Tyre pressure has been changed
- Load condition has been changed
- Wheels have been swapped or exchanged

The system will not warn instantaneously on a tyre blow out or a rapid deflation. This is due to required calculation time.

Tread depth

Check tread depth at regular intervals.

Tyres should be replaced for safety reasons at a tread depth of 2-3 mm (4 mm for winter tyres).

For safety reasons, it is recommended that the tread depth of the tyres on one axle should not vary by more than 2 mm.



The legally permissible minimum tread depth (1.6 mm) has been reached when the tread has worn down as far as one of the tread wear

indicators (TWI). Their position is indicated by markings on the sidewall.

If there is more wear at the front than the rear, swap round front wheels and rear wheels periodically. Ensure that the direction of rotation of the wheels remains the same.

Tyres age, even if they are not used. We recommend tyre replacement every 6 years.

Changing tyre and wheel size

If tyres of a different size than those fitted at the factory are used, it may be necessary to reprogramme the tyre deflation detection system and make other vehicle modifications.

Tyre deflation detection system
↻ 180.

Have the label with tyre pressures replaced.

⚠ Warning

The use of unsuitable tyres or wheels may lead to accidents and will invalidate the vehicle operating permit.

Wheel covers

Wheel covers and tyres that are factory approved for the respective vehicle and comply with all of the relevant wheel and tyre combination requirements must be used.

If the wheel covers and tyres used are not factory approved, the tyres must not have a rim protection ridge.

Wheel covers must not impair brake cooling.

⚠ Warning

Use of unsuitable tyres or wheel covers could lead to sudden pressure loss and thereby accidents.

Vehicles with steel wheels: When using locking wheel nuts, do not attach wheel covers.

Tyre chains

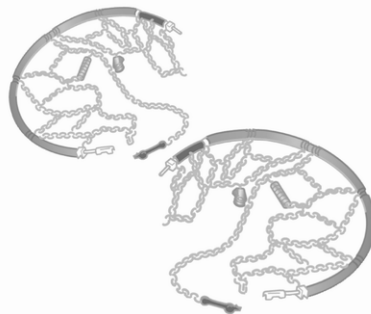

Tyre chains are only permitted on the front wheels.

Always use fine mesh chains that add no more than 9 mm to the tyre tread and the inboard sides (including chain lock).

⚠ Warning

Damage may lead to tyre blowout.

Tyre chains are permitted on tyres of size 185/65R15 and 195/55R16.

Temporary spare wheel

The use of tyre chains is not permitted on the temporary spare wheel.

Tyre repair kit

Minor damage to the tyre tread can be repaired with the tyre repair kit.

Do not remove foreign bodies from the tyres.

Tyre damage exceeding 4 mm or that is at tyre's sidewall cannot be repaired with the tyre repair kit.

⚠ Warning

Do not drive faster than 80 km/h.
Do not use for a lengthy period.
Steering and handling may be affected.

In the case of a flat tyre:

Apply the parking brake and engage first gear, reverse gear or **P**.

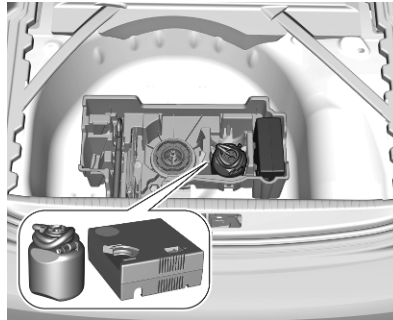

The tyre repair kit is in the load compartment below the floor cover.

1. Remove the sealant bottle and the compressor.
2. Pull speed limit label from sealant bottle and place it in driver's visible area.

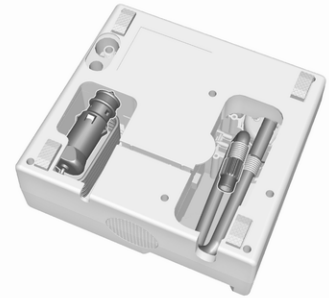

3. Remove the electrical connection cable and air hose from the stowage compartments on the underside of the compressor.

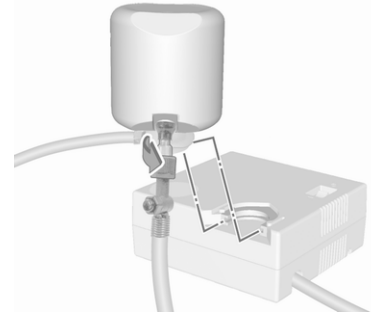

4. Screw the compressor air hose to the connection on the sealant bottle.
5. Fit the sealant bottle into the bracket on the compressor.
Set the compressor near the tyre in such a way that the sealant bottle is upright.
6. Unscrew valve cap from defective tyre.

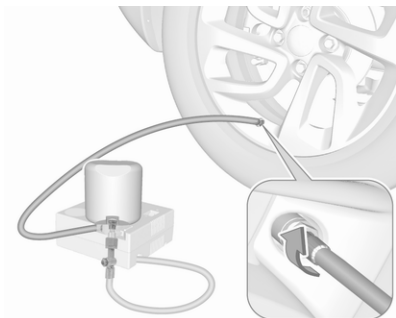

7. Screw the filler hose to the tyre valve.
8. The switch on the compressor must be set to O.

9. Connect the compressor plug to the power outlet or cigarette lighter socket ↷ 59.

To avoid discharging the battery, we recommend running the engine.

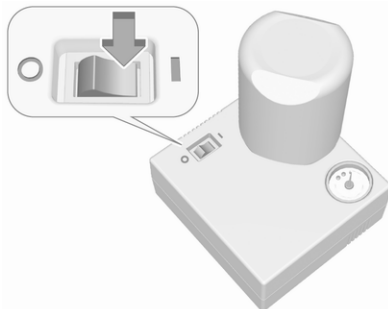

10. Set the rocker switch on the compressor to I. The tyre is filled with sealant.
11. The compressor pressure gauge briefly indicates up to 600 kPa (6 bar) whilst the sealant bottle is emptying (approx. 30 seconds). Then the pressure starts to drop.

12. All of the sealant is pumped into the tyre. Then the tyre is being inflated.

13. The prescribed tyre pressure should be obtained within 10 minutes.

Tyre pressure ↷ 210.

When the correct pressure is obtained, switch off the compressor.

If the prescribed tyre pressure is not obtained within 10 minutes, remove the tyre repair kit. Move the vehicle one tyre rotation. Reattach the tyre repair kit and continue the filling procedure for 10 minutes. If the prescribed tyre pressure is still not obtained, the tyre is too badly damaged. Seek the assistance of a workshop.

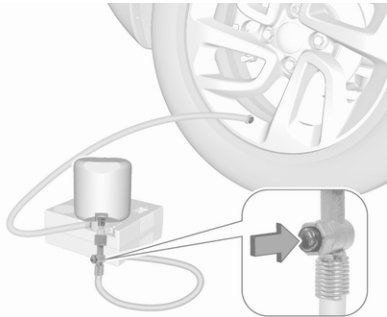

Drain excess tyre pressure with the button on the air hose.

Do not run the compressor longer than 10 minutes.

14. Detach the tyre repair kit. Remove sealant bottle from bracket. Screw the filler hose to the free connection of the sealant bottle. This prevents sealant from escaping. Stow tyre repair kit in load compartment.
15. Remove any excess sealant using a cloth.

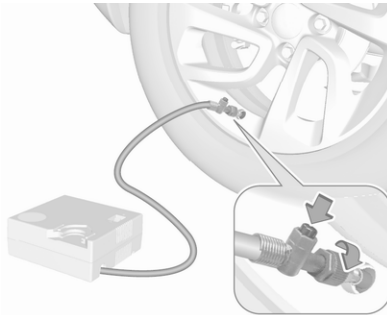

16. Continue driving immediately so that sealant is evenly distributed in the tyre. Drive between 20 km/h and 60 km/h. After driving approx. 5 km but no more than 10 minutes, stop and check tyre pressure. Screw compressor air hose directly onto tyre valve when doing this. Fill tyre as described before. Drain excess tyre pressure with the button on the air hose.

If tyre pressure hasn't decreased under 200 kPa (2 bar), set it to the correct value. Otherwise the vehicle must not be used. Seek assistance of a workshop ↗ 210.

Repeat the checking procedure once more after driving further 10 km but no more than 10 minutes to check that there is no more loss of pressure.

If the tyre pressure has fallen below 200 kPa (2 bar), the vehicle must not be used. Seek the assistance of a workshop.

17. Stow away tyre repair kit in load compartment.

Note

The driving characteristics of the repaired tyre are severely affected, therefore have this tyre replaced.

If unusual noise is heard or the compressor becomes hot, turn compressor off for at least 30 min.

The built-in safety valve opens at a pressure of 700 kPa (7 bar).

Note the expiry date of the kit. After this date its sealing capability is no longer guaranteed. Pay attention to storage information on sealant bottle.

Replace the used sealant bottle. Dispose of the bottle as prescribed by applicable laws.

The compressor and sealant can be used from approx. -30°C .

Wheel changing

Make the following preparations and observe the following information:

- Park the vehicle on a level, firm and non-skid surface. The front wheels must be in the straight-ahead position.
- If necessary, place a chock under the wheel diagonally opposite the wheel to be changed.
- Apply the parking brake and engage first gear, reverse gear or **P**.
- If the ground on which the vehicle is standing is soft, a solid board (max. 1 cm thick) should be placed under the jack.
- Take heavy objects out of the vehicle before jacking up.
- No people or animals may be in the vehicle when it is jacked-up.

- Never crawl under a jacked-up vehicle.
- Do not start the vehicle when it is raised on the jack.
- Before screwing in the wheel bolts, clean them.

Warning

Do not grease wheel bolts.

Tightening torques

Caution

If the vehicle is equipped with alloy wheels, tighten the wheel bolts manually at least for the first five turns.

There are two different types of wheels with two different bolts and tightening torques.

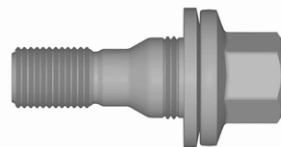

Tightening torque for alloy wheels is 115 Nm.



Tightening torque for steel wheels:

- 15" steel wheel bolts should be tightened with 100 Nm.
- 16" steel wheel bolts should be tightened with 115 Nm.

Use the correct wheel bolts for the respective wheels.

Jacking positions

The jacking positions shown refer to the use of lifting arms and accessory jacks used for changing winter / summer tyres.



Rear arm position of the lifting platform centrally under the relevant vehicle jacking point.

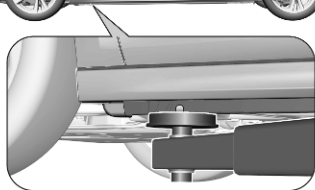

Front arm position of the lifting platform centrally under the relevant vehicle jacking point.

Spare wheel

The spare wheel can be classified as a temporary spare wheel depending on the size compared to the other mounted wheels and country regulations. In this case a permissible maximum speed applies, even though no label at the spare wheel indicates this.

Only mount one temporary spare wheel. Do not drive faster than 80 km/h. Take curves slowly. Do not use for a long period of time.

Caution

The use of a spare wheel that is smaller than the other wheels or in combination with winter tyres could affect driveability. Have the defective tyre replaced as soon as possible.

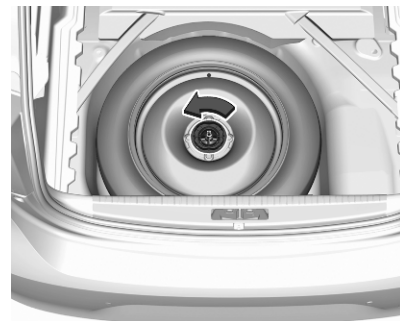

The spare wheel is located in the load compartment beneath the floor covering.

To remove:

1. Open the floor cover ↗ 51.
2. The temporary spare wheel is secured with a wing nut. Unscrew nut and take out the spare wheel.
3. When, after a wheel change, no wheel is placed in the spare wheel well, tighten the wing nut and close floor cover.
4. After wheel change back to full size wheel, place the temporary spare wheel outside up in the well and secure with the wing nut.

Only mount one temporary spare wheel. The permissible maximum speed on the label on the temporary spare wheel is only valid for the factory-fitted tyre size.

Fitting the spare wheel

Make the following preparations and observe the following information:

- Park the vehicle on a level, firm and non-skid surface. The front wheels must be in the straight-ahead position.
- If necessary, place a chock under the wheel diagonally opposite the wheel to be changed.
- Apply the parking brake and engage first gear, reverse gear or **P**.
- Remove the spare wheel.
- Never change more than one wheel at once.
- Use the jack only to change wheels in case of puncture, not for seasonal winter or summer tyre change.
- The jack is maintenance-free.

- If the ground on which the vehicle is standing is soft, a solid board (max. 1 cm thick) should be placed under the jack.
- Take heavy objects out of the vehicle before jacking up.
- No people or animals may be in the vehicle when it is jacked-up.
- Never crawl under a jacked-up vehicle.
- Do not start the vehicle when it is raised on the jack.
- Before screwing in the wheel bolts, clean them.

Warning

Do not grease wheel bolts.

Warning

Ensure to use always the correct wheel bolts if changing the wheels. When installing the spare wheel, the bolts for alloy wheels can also be used.

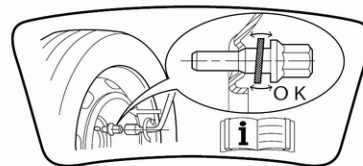

- Note that the spare wheel is secured by the conical contact of each bolt if the wheel bolts for the alloy wheels are used. In this case, the washers do not come into contact with the spare wheel.

1. Disengage wheel bolt caps with the wheel bolt cover remover.

Vehicle tools ⇨ 178.

Steel wheels with cover: Pull off the wheel cover.

Alloy wheels: Disengage wheel bolt caps with the wheel bolt cover remover.



2. Attach the wheel wrench and loosen each wheel bolt by half a turn.

The wheels might be protected by locking wheel nuts. To loosen these specific nuts first attach the adapter onto the head of the nut before installing the wheel wrench. The adapter is located in the tool bag ↗ 178.



3. Ensure the jack is correctly positioned under the relevant vehicle jacking point.

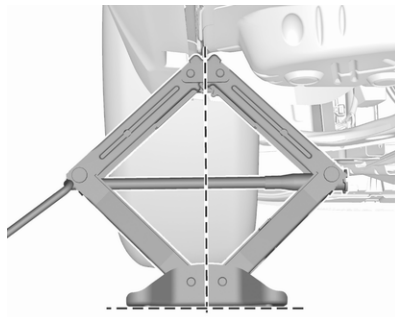

4. Set the jack to the necessary height. Position it directly below

the jacking point in a manner that prevents it from slipping.

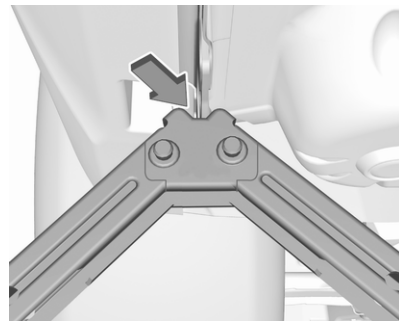

Ensure that the edge of the body fits into the notch of the jack.



With the jack correctly aligned rotate wheel wrench until wheel is clear of the ground.

5. Unscrew the wheel nuts.
6. Change the wheel.
7. Screw on the wheel nuts.
8. Lower the vehicle and remove jack.
9. Install the wheel wrench ensuring that it is located securely and tighten each bolt in a crosswise sequence.

Tightening torque for 15" is 100 Nm and for 16" is 115 Nm.

If the vehicle is equipped with alloy wheels, note that the wheel bolts can also be used for the steel spare wheel. In this case, the spare wheel is secured by the conical contact of each bolt.

10. Vehicles with wheel cover: Align the valve hole in the wheel cover with the tyre valve before installing.

Install wheel nut caps.

11. Stow the replaced wheel, the vehicle tools and the adapter for the locking wheel nuts ⇨ 178.
12. Check the tyre pressure of the installed tyre and the wheel nut torque as soon as possible.

Stowing a damaged full size wheel in the load compartment

The damaged full size wheel can be stowed in the spare wheel well. To secure the wheel:



1. Remove centre cap with the brand emblem by pushing from the inside.
2. Position the wheel outside down in the wheel well.
3. Secure the defective wheel with the wing nut.
4. Depending on the tyre size, the floor cover can be placed on the projecting wheel.

Jump starting

Do not start with quick charger.

A vehicle with a discharged vehicle battery can be started using jump leads and the vehicle battery of another vehicle.

⚠ Warning

Be extremely careful when starting with jump leads. Any deviation from the following instructions can lead to injuries or damage caused by battery explosion or damage to the electrical systems of both vehicles.

⚠ Warning

Avoid contact of the battery with eyes, skin, fabrics and painted surfaces. The fluid contains sulphuric acid which can cause injuries and damage in the event of direct contact.

- Never expose the vehicle battery to naked flames or sparks.

- A discharged vehicle battery can already freeze at a temperature of 0 °C. Defrost the frozen battery before connecting jump leads.
- Wear eye protection and protective clothing when handling a battery.
- Use a booster battery with the same voltage (12 V). Its capacity (Ah) must not be much less than that of the discharged vehicle battery.
- Use jump leads with insulated terminals and a cross section of at least 16 mm² (25 mm² for diesel engines).
- Do not disconnect the discharged vehicle battery from the vehicle.
- Switch off all unnecessary electrical consumers.
- Do not lean over the vehicle battery during jump starting.
- Do not allow the terminals of one lead to touch those of the other lead.

- The vehicles must not come into contact with each other during the jump starting process.
- Apply the parking brake, transmission in neutral, automatic transmission in P.

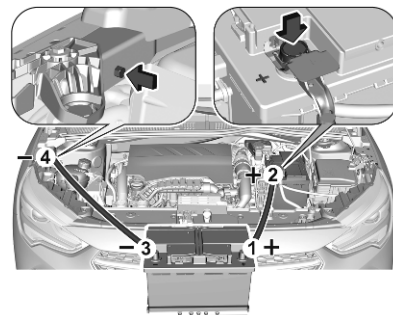

Lead connection order:

1. Connect the red lead to the positive terminal of the booster battery.
2. Connect the other end of the red lead to the positive terminal of the discharged battery.

3. Connect the black lead to the negative terminal of the booster battery.
4. Connect the other end of the black lead to a vehicle grounding point of your vehicle in the engine compartment.

Route the leads so that they cannot catch on rotating parts in the engine compartment.

To start the engine:

1. Start the engine of the vehicle providing the jump.
2. After 5 minutes, start the other engine. Start attempts should be made for no longer than 15 seconds at an interval of 1 minute.
3. Allow both engines to idle for approx. 3 minutes with the leads connected.
4. Switch on the needed electrical consumers e.g. headlights, heated rear window.
5. Reverse above sequence exactly when removing leads.

Towing

Towing the vehicle

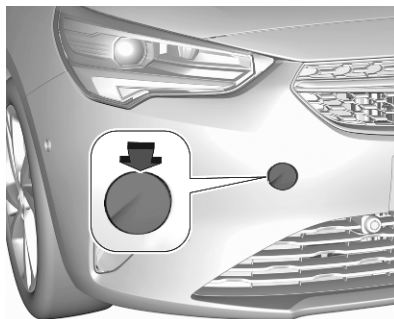

Remove the cap.
The towing eye is stowed with the vehicle tools ↗ 178.

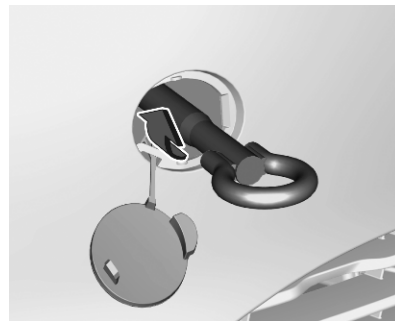

Screw in the towing eye as far as it will go until it stops in a horizontal position.

Attach the tow rod to the towing eye.

The towing eye must only be used for towing and not for recovering the vehicle.

Switch on ignition to release steering wheel lock and to permit operation of brake lights, horn and windscreen wiper.

Caution

Deactivate the driver assistance systems like active emergency braking ⇨ 132, otherwise the vehicle may automatically brake during towing.

Switch the selector lever to neutral.
Release the parking brake.

Caution

Drive slowly. Do not drive jerkily. Excessive tractive force can damage the vehicle.

When the engine is not running, considerably more force is needed to brake and steer.

To prevent the entry of exhaust gases from the towing vehicle, switch on the air recirculation and close the windows.



When towing vehicles equipped with an automatic transmission, transport the vehicle on a platform or tow it with the front wheels lifted.

Seek the assistance of a workshop.

After towing, unscrew the towing eye.

Insert cap with the flange into the recess and fix cap by pushing.

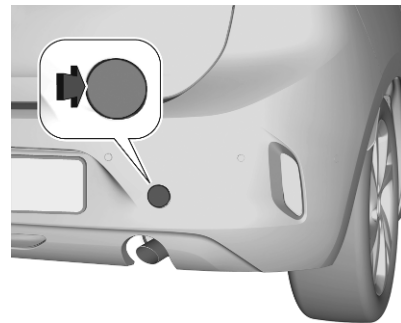
Towing another vehicle

Remove the cap.

The towing eye is stowed with the vehicle tools ⇨ 178.

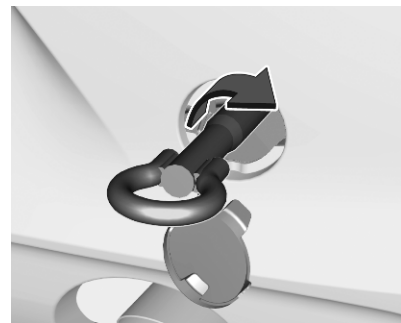

Screw in the towing eye as far as it will go until it stops in a horizontal position.

The lashing eye at the rear underneath the vehicle must never be used as a towing eye.

Attach a tow rope – or better still a tow rod – to the towing eye.

The towing eye must only be used for towing and not for recovering a vehicle.

Caution

Drive slowly. Do not drive jerkily. Excessive tractive force can damage the vehicle.

After towing, unscrew the towing eye. Insert cap with the upper flange into the recess and fix cap by pushing.

Appearance care

Exterior care

Locks

The locks are lubricated at the factory using a high quality lock cylinder grease. Use a de-icing agent only when absolutely necessary, as this has a degreasing effect and impairs lock function. After using a de-icing agent, have the locks regreased by a workshop.

Washing

The paintwork of your vehicle is exposed to environmental influences.

Bird droppings, dead insects, resin, pollen and the like should be cleaned off immediately, as they contain aggressive constituents which can cause paint damage.

If using a vehicle wash, comply with the vehicle wash manufacturer's instructions. The windscreen wiper and rear window wiper must be

switched off. Remove antenna and external accessories such as roof racks etc.

If you wash your vehicle by hand, make sure that the insides of the wheel housings are also thoroughly rinsed out.

Clean edges and folds on opened doors and the bonnet as well as the areas they cover.

Clean bright metal mouldings with a cleaning solution approved for aluminium to avoid damages.

Caution

Always use a cleaning agent with a pH value of 4 to 9.

Do not use cleaning agents on hot surfaces.

Do not clean the engine compartment with a steam-jet or high-pressure jet cleaner.

Thoroughly rinse and leather-off the vehicle. Rinse leather frequently. Use separate leathers for painted and glass surfaces: remnants of wax on the windows will impair vision.

Have the door hinges of all doors greased by a workshop.

Do not use hard objects to remove spots of tar. Use tar removal spray on painted surfaces.

Exterior lights

Headlight and other light covers are made of plastic. Do not use any abrasive or caustic agents, do not use an ice scraper, and do not clean them dry.

Polishing and waxing

Polishing is necessary only if the paint has become dull or if solid deposits have become attached to it.

Plastic body parts must not be treated with wax or polishing agents.

Windows and wiper blades

Switch off wipers before handling in their areas.

Use a soft lint-free cloth or chamois leather together with window cleaner and insect remover.

When cleaning the rear window from inside, always wipe in parallel to the heating element to prevent damage.

For mechanical removal of ice, use a sharp-edged ice scraper. Press the scraper firmly against the glass so that no dirt can get under it and scratch the glass.

Clean smearing wiper blades with a soft cloth and window cleaner. Also make sure to remove any residues such as wax, insect residues and similar from the window.

Ice residues, pollution and continuous wiping on dry windows will damage or even destroy the wiper blades.

Wheels and tyres

Do not use high-pressure jet cleaners.

Clean rims with a pH-neutral wheel cleaner.

Rims are painted and can be treated with the same agents as the body.

Paintwork damage

Rectify minor paintwork damage with a touch-up pen before rust forms. Have more extensive damage or rust areas repaired by a workshop.

Underbody

Some areas of the vehicle underbody have a PVC undercoating while other critical areas have a durable protective wax coating.

After the underbody is washed, check the underbody and have it waxed if necessary.

Bitumen / rubber materials could damage the PVC coating. Have underbody work carried out by a workshop.

Before and after winter, wash the underbody and have the protective wax coating checked.

Towing equipment

Do not clean the coupling ball bar with a steam-jet or high-pressure jet cleaner.

Interior care

Interior and upholstery

Only clean the vehicle interior, including the instrument panel fascia and panelling, with a dry cloth or interior cleaner.

Clean the leather upholstery with clear water and a soft cloth. In case of heavy soiling, use leather care.

The instrument cluster and the displays should only be cleaned using a soft damp cloth. If necessary use a weak soap solution.

Clean fabric upholstery with a vacuum cleaner and brush. Remove stains with an upholstery cleaner.

Clothing fabrics may not be colourfast. This could cause visible discolourations, especially on light-coloured upholstery. Removable stains and discolourations should be cleaned as soon as possible.

Clean seat belts with lukewarm water or interior cleaner.

Caution

Close Velcro fasteners as open Velcro fasteners on clothing could damage seat upholstery.

The same applies to clothing with sharp-edged objects, like zips or belts or studded jeans.

Plastic and rubber parts

Plastic and rubber parts can be cleaned with the same cleaner as used to clean the body. Use interior cleaner if necessary. Do not use any other agent. Avoid solvents and petrol in particular. Do not use high-pressure jet cleaners.

Floor mats

Warning

If a floor mat has the wrong size or is not properly installed, it can interfere with the accelerator pedal and/or brake pedal, what can cause unintended acceleration

and/or increased stopping distance which can cause a crash and injury.

Use the following guidelines for proper floor mat usage.

- The original equipment floor mats were designed for your vehicle. If the floor mats need replacing, it is recommended that certified floor mats be purchased. Always check that the floor mats do not interfere with the pedals.
- Use the floor mat with the correct side up. Do not turn it over.
- Do not place anything on top of the driver side floor mat.
- Use only a single floor mat on the driver side.
- Do not place one floor mat on top of another.

Inserting and removing the floor mats

The driver side floor mat is held in place by two retainers.

To install the floor mat:

1. Move the seat backwards as far as possible.

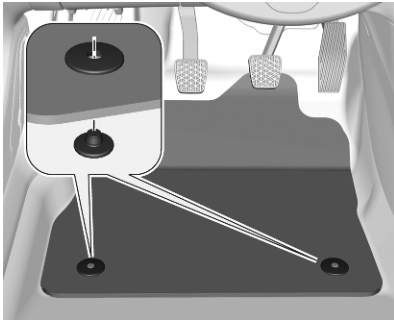

2. Align slots in the mat with the retainers, as shown.
3. Push the mat to the floor.

Removing

1. Move the seat backwards as far as possible.
2. Remove the mat.

Service and maintenance

General information	198
Service information	198
Recommended fluids, lubricants and parts	201
Recommended fluids and lubricants	201

General information

Service information

In order to ensure economical and safe vehicle operation and to maintain the value of your vehicle, it is of vital importance that all maintenance work is carried out at the proper intervals as specified.

The detailed, up-to-date service schedule for your vehicle is available at the workshop.

Severe operating conditions exist if one or more of the following circumstances occur frequently: Cold starting, stop and go operation, e.g. for taxis and police vehicles, trailer operation, mountain driving, driving on poor and sandy road surfaces, increased air pollution, presence of airborne sand and high dust content, driving at high altitude and large variations of temperature.

Under these severe operating conditions, certain service work may be required more frequently than the regular service interval indicated in

the service display. Contact a workshop for customised service schedules.

Service display ⇨ 65.

Service intervals

Engine code	EB2FA	EB2ADTD EB2ADTS	DV5RD
Country group 1	20,000 km / 1 year	20,000 km / 1 year	30,000 km / 1 year ¹⁾
Country group 2	20,000 km / 1 year	15,000 km / 1 year	30,000 km / 1 year ¹⁾
Country group 3	20,000 km / 1 year	15,000 km / 1 year	15,000 km / 1 year
Country group 4	15,000 km / 1 year	15,000 km / 1 year	15,000 km / 1 year
Country group 5	10,000 km / 1 year	10,000 km / 1 year	10,000 km / 1 year

1) Unless otherwise indicated in the service display.

Country Group 1:

Andorra, Austria, Belgium, Cyprus, Denmark, Finland, France, Germany, Greece, Iceland, Republic of Ireland, Italy, Liechtenstein, Luxembourg, Malta, Monaco, Netherlands, Norway, Portugal, San Marino, Spain, Sweden, Switzerland, United Kingdom.

Country Group 2:

Bosnia-Herzegovina, Bulgaria, Croatia, Czech Republic, Estonia, North Macedonia, Hungary, Latvia, Lithuania, Poland, Romania, Slovakia, Slovenia.

Country Group 3:

Albania, Montenegro, Serbia.

Country Group 4:

Israel, South Africa, Turkey, Lesotho, Swaziland.

Country Group 5:

All other countries which are not listed in the previous country groups.

Confirmations

Confirmation of service is recorded in the Service and warranty booklet. The date and mileage is completed with the stamp and signature of the servicing workshop.

Make sure that the Service and warranty booklet is completed correctly as continuous proof of service is essential if any warranty or goodwill claims are to be met, and is also a benefit when selling the vehicle.

Recommended fluids, lubricants and parts

Recommended fluids and lubricants

Only use products that meet the recommended specifications.

Warning

Operating materials are hazardous and could be poisonous. Handle with care. Pay attention to information given on the containers.

Engine oil

Engine oil is identified by its quality and its viscosity. Quality is more important than viscosity when selecting which engine oil to use. The oil quality ensures e.g. engine cleanliness, wear protection and oil aging control, whereas viscosity grade gives information on the oil's thickness over a temperature range.

Select the appropriate engine oil based on its quality and on the minimum ambient temperature ⇨ 205.

Topping up engine oil

Caution

In case of any spilled oil, wipe it up and dispose it properly.

Engine oils of different manufacturers and brands can be mixed as long as they comply with the required engine oil quality and viscosity.

Use of engine oils for all petrol engines with only ACEA quality is prohibited, since it can cause engine damage under certain operating conditions.

Select the appropriate engine oil based on its quality and on the minimum ambient temperature ⇨ 205.

Additional engine oil additives

The use of additional engine oil additives could cause damage and invalidate the warranty.

Engine oil viscosity grades

The SAE viscosity grade gives information of the thickness of the oil.

Multigrade oil is indicated by two figures, e.g. SAE 5W-30. The first figure, followed by a W, indicates the low temperature viscosity and the second figure the high temperature viscosity.

Select the appropriate viscosity grade depending on the minimum ambient temperature ⇨ 205.

All of the recommended viscosity grades are suitable for high ambient temperatures.

Coolant and antifreeze

Use only Lobrid antifreeze approved for the vehicle. Consult a workshop.

The system is factory filled with coolant designed for excellent corrosion protection and frost protection down to approx. -28 °C. In cold regions with very low temperatures the factory filled coolant provides frost protection down to approx. -37 °C. This concentration should be maintained all year round.

The use of additional coolant additives that intend to give additional corrosion protection or seal against minor leaks can cause function problems. Liability for consequences resulting from the use of additional coolant additives will be rejected.

Washer fluid

Use only washer fluid approved for the vehicle to prevent damage of wiper blades, paintwork, plastic and rubber parts. Consult a workshop.

Brake and clutch fluid

Over time, brake fluid absorbs moisture which will reduce braking effectiveness. The brake fluid should therefore be replaced at the specified interval.

AdBlue

Only use AdBlue to reduce the nitrogen oxides in the exhaust emission ↪ 107.

Technical data

Vehicle identification	203
Vehicle identification number ..	203
Identification plate	203
Engine identification	204
Vehicle data	205
Recommended fluids and lubricants	205
Engine data	207
Performance	208
Vehicle dimensions	209
Capacities	210
Tyre pressures	211

Vehicle identification

Vehicle identification number

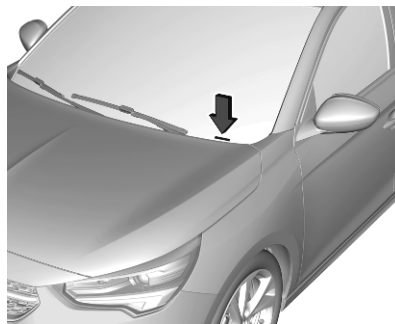

The Vehicle Identification Number may be embossed on the instrument panel, visible through the windscreen, or in the engine compartment on the right body panel.

Identification plate

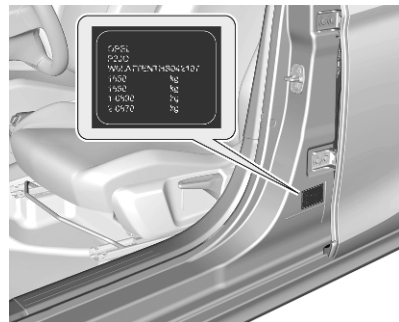

The identification plate is located on the front left or right door frame.

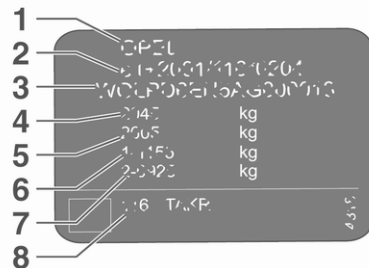

Information on identification label:

- 1 : manufacturer
- 2 : type approval number
- 3 : vehicle identification number
- 4 : permissible gross vehicle weight rating in kg
- 5 : permissible gross train weight in kg
- 6 : maximum permissible front axle load in kg
- 7 : maximum permissible rear axle load in kg
- 8 : vehicle-specific or country-specific data

The combined total of front and rear axle loads must not exceed the permissible gross vehicle weight.

Vehicle's kerb weight depends on the specification of the vehicle, e.g. optional equipment and accessories. Refer to the EEC Certificate of Conformity provided with your vehicle or other national registration documents.

The technical data is determined in accordance with European Community standards. We reserve the right to make modifications.

Specifications in the vehicle documents always have priority over those given in this manual.

Engine identification

The technical data tables show the engine identifier code.

Engine data ↗ 207.

To identify the respective engine, refer to the engine power in the EEC Certificate of Conformity provided with your vehicle or other national registration documents.

Vehicle data

Recommended fluids and lubricants

Required engine oil quality

Country groups ⇨ 198

Countries included in country groups 1 to 3

EB2FA		
EB2ADT		EP6FDTM
EB2ADTD		EB2DT
EB2ADTS		EC5F
EP6FADTXD		DW10FC
DV5RC		DV6D
DV5RD		DV6FD
DV5RE		DV6FE

Opel Original engine oil

B71 2010 / B71 2312

B71 2312

Engine EC5F: B71 2290, B71 2296 or B71 300 may also be used.

Countries included in country group 4

all engines

Opel Original engine oil

B71 2302 / B71 2297

Engine EC5F: B71 2296 or B71 300 may also be used.

206 Technical data

Countries included in country group 5

all engines

Opel Original engine oil

B71 2297

Engine oil viscosity grades

Country groups ↗ 198

	B71 2010	B71 2312	B71 2302	B71 2297
Engine oil viscosity grade	SAE 0W-20	SAE 0W-30	SAE 0W-30	SAE 5W-30

Engine data

Engine identifier code	EB2FA	EB2ADTD	EB2ADTS	DV5RD
Sales designation	1.2	1.2 T	1.2 T	1.5 D
Piston displacement [cm ³]	1199	1199	1199	1499
Engine power [kW]	55	74	96	75
at rpm	5750	5500	5500	3500
Torque [Nm]	118	205	230	250
at rpm	2750	1750	1750	1750
Fuel type	Petrol	Petrol	Petrol	Diesel
Octane rating RON ¹⁾²⁾				
recommended	95	95	95	–
possible	98	98	98	–
possible	91	91	91	–
Additional fuel type	–	–	–	–

1) A country specific label at the fuel filler flap can supersede the engine specific requirement.

2) In certain countries, the use of a particular fuel, e.g. a specific octane rating, may be required to ensure proper engine operation.

Performance

Engine	EB2FA	EB2ADTD	EB2ADTS	DV5RD
Maximum speed [km/h]				
Manual transmission	174	188	–	188
Automatic transmission	–	188	208	–

Vehicle dimensions

Length [mm]	4060
Width without exterior mirrors [mm]	1745
Width with two exterior mirrors folded [mm]	1791
Width with two exterior mirrors [mm]	1960
Height (without antenna) [mm]	1432
Length of load compartment floor [mm]	680
Length of load compartment with folded second row [mm]	1385
Load compartment width between wheel arches [mm]	1018
Load compartment width at seat belt height [mm]	833
Wheelbase [mm]	2538
Turning circle diameter [m]	10.32

Capacities**Engine oil**

Engine	EB2FA	EB2ADTD	EB2ADTS	DV5RD
including filter [l]	3.25	3.5	3.5	4.0
between MIN and MAX [l]	1.0	1.0	1.0	1.5

Fuel tank

Petrol, refilling quantity [l]				44
Diesel, refilling quantity [l]				41

AdBlue tank

AdBlue, refilling quantity [l]				13
--------------------------------	--	--	--	----

Tyre pressures

Engine	Tyres	Vehicle with up to 3 people		With full load	
		front [kPa/bar] ([psi])	rear [kPa/bar] ([psi])	front [kPa/bar] ([psi])	rear [kPa/bar] ([psi])
EB2FA	185/65 R15, 195/55 R16, 205/45 R17 195/55 R16	220/2.2 (32)	210/2.1 (30)	270/2.7 (39)	290/2.9 (42)
EB2ADTD, EB2ADTS DV5RD	195/55 R16, 205/45 R17	220/2.2 (32)	210/2.1 (30)	270/2.7 (39)	290/2.9 (42)
All	Temporary spare wheel 115/70 R15	420/4.2 (60)	420/4.2 (60)	420/4.2 (60)	420/4.2 (60)

Customer information

Customer information	212
Declaration of conformity	212
REACH	214
Software acknowledgement	214
Software update	216
Registered trademarks	216
Vehicle data recording and privacy	217
Event data recorders	217
Radio Frequency Identification (RFID)	220

Customer information

Declaration of conformity

Radio transmission systems

This vehicle has systems that transmit and / or receive radio waves subject to Directive 2014/53/EU. The manufacturers of the systems listed below declare conformity with Directive 2014/53/EU. The full text of the EU declaration of conformity for each system is available at the following internet address: www.opel.com/conformity.

Importer is
Opel / Vauxhall, Bahnhofspatz,
65423 Ruesselsheim am Main,
Germany.

Infotainment system Multimedia Navi Pro / Multimedia Navi

Continental Automotive Czech
Republic s.r.o

Prumyslová 1851, 250 01 Brandys
nad Labem, Czech Republic

Operation frequency (MHz)	Maximum output (dBm)
---------------------------	----------------------

BT 2402.0 - 2480.0	4.1
--------------------	-----

Wifi 2412.0 - 2462.0	16.7
----------------------	------

Infotainment system Radio

Hangsheng technology GmbH
Bouchéstr. 12, 12435 Berlin,
Germany

Operation frequency:
2402.0 - 2480.0 MHz

Maximum output: 4 dBm

Infotainment system Multimedia

Robert Bosch Car Multimedia GmbH
Robert-Bosch-Strasse 200, 31139
Hildesheim, Germany

Operation frequency:
2400.0 - 2483.5 MHz

Maximum output: 4 dBm

Wireless charger

Continental Automotive GmbH

Siemensstrasse 12, 93055
Regensburg, Germany

Operation frequency:
90.0 - 119.0 MHz

Maximum output:
39.24dB μ A/m @ 3m

Antenna module

Hirschmann Car Communication
GmbH

Stuttgarter Strasse 45-51, 72654
Neckartenzlingen, Germany

Operation frequency: N/A

Maximum output: N/A

ASK Industrie SpA

C.P. 110 c/o U.P. RE2, 42121 Reggio
Emilia, Italy

Operation frequency: N/A

Maximum output: N/A

Fiamm France - RCA Spa

12 rue Augustin Fresnel, 78420
Aubergenville, France

Operation frequency: N/A

Maximum output: N/A

Electronic key transmitter

Valeo Comfort and Driving
Assistance

76, rue Auguste Perret 94046 Créteil
- CEDEX France

Operation frequency:
433.05 - 434.79 MHz

Maximum output: 10 dBm

Electronic key receiver

Valeo Comfort and Driving
Assistance

76, rue Auguste Perret 94046 Créteil
- CEDEX France

Operation frequency: 125 MHz

Maximum output: -7.3 dBm

Radio remote control transmitter

Huf Hülsbeck & Fürst GmbH & Co.
KG

Steeper Str. 17, 42551 Velbert,
Germany

Operation frequency:
433.05 - 434.79 MHz

Maximum output: -14 dBm

Radio remote control receiver

Aptiv Services France SAS

22 Avenue des Nations ZAC Paris
Nord II 93420 Villepinte France

Operation frequency: 125 MHz

Maximum output: 66 dB μ A/m at 10m

Immobiliser

Kostal Bulgaria Automotive
Pazardzhik

ul. "Sinitevska" 4, 4400 Southern
Industrial Zone, Bulgaria

Operation frequency: 119 - 134 kHz

Maximum output: 72 dB μ A/m at 10m

Radar unit

ZF TRW Autocruise SAS

Secteur de la Pointe du Diable,
Avenue du technopôle, 29280
Plouzane, France

Operation frequency:
76.0 - 77.0 GHz

Maximum output: 28 dBm

BTA Module

Marelli S.p.A.

Viale A. Borletti 61/63, 20011
Corbetta, Italy

	Operation frequency (MHz)	Maximum output (dBm)
GSM 900	880 - 915	33
GSM 1800	1710 - 1880	30
UMTS	880 - 960	24
	1920 - 1980	24

ICASA type approval numbers

List of all Independent Communications Authority of South Africa (ICASA) type approval numbers:

TA-2018/5025, TA-2018/5031, TA-2017/2387, TA-2018/1848, TA-2018/208, TA-2017/1106, TA-2017/3180

REACH

Registration, Evaluation, Authorisation and Restriction of Chemicals (REACH) is a European Union regulation adopted to improve the protection of human health and the environment from the risks that can be posed by chemicals. Visit www.opel.com for further information and for access to the Article 33 communication.

Software acknowledgement

Certain OnStar components include libcurl and unzip software and other third party software. Below are the notices and licenses associated with libcurl and unzip and for other third party software please see <http://www.lg.com/global/support/opensource/index>.

libcurl

Copyright and permission notice
Copyright (c) 1996 - 2010, Daniel Stenberg, <daniel@haxx.se>.

All rights reserved.

Permission to use, copy, modify, and distribute this software for any purpose with or without fee is hereby granted, provided that the above copyright notice and this permission notice appear in all copies.

The software is provided "as is", without warranty of any kind, express or implied, including but not limited to the warranties of merchantability, fitness for a particular purpose and noninfringement of third party rights. In no event shall the authors or copyright holders be liable for any claim, damages or other liability, whether in an action of contract, tort or otherwise, arising from, out of or in connection with the software or the use or other dealings in the software.

Except as contained in this notice, the name of a copyright holder shall not be used in advertising or otherwise to promote the sale, use or other dealings in this Software without prior written authorization of the copyright holder.

unzip

This is version 2005-Feb-10 of the Info-ZIP copyright and license. The definitive version of this document should be available at <ftp://ftp.info-zip.org/pub/infozip/license.html> indefinitely.

Copyright (c) 1990-2005 Info-ZIP. All rights reserved.

For the purposes of this copyright and license, "Info-ZIP" is defined as the following set of individuals:

Mark Adler, John Bush, Karl Davis, Harald Denker, Jean-Michel Dubois, Jean-loup Gailly, Hunter Goatley, Ed Gordon, Ian Gorman, Chris Herborth, Dirk Haase, Greg Hartwig, Robert Heath, Jonathan Hudson, Paul Kienitz, David Kirschbaum, Johnny Lee, Onno van der Linden, Igor Mandrichenko, Steve P. Miller, Sergio Monesi, Keith Owens, George Petrov, Greg Roelofs, Kai Uwe Rommel, Steve Salisbury, Dave Smith, Steven M. Schweda, Christian Spieler, Cosmin Truta, Antoine Verheijen, Paul von Behren, Rich Wales, Mike White.

This software is provided "as is," without warranty of any kind, express or implied. In no event shall Info-ZIP or its contributors be held liable for any direct, indirect, incidental, special or consequential damages arising out of the use of or inability to use this software.

Permission is granted to anyone to use this software for any purpose, including commercial applications, and to alter it and redistribute it freely, subject to the following restrictions:

1. Redistributions of source code must retain the above copyright notice, definition, disclaimer, and this list of conditions.
2. Redistributions in binary form (compiled executables) must reproduce the above copyright notice, definition, disclaimer, and this list of conditions in documentation and/or other materials provided with the distribution. The sole exception to this condition is redistribution of a standard UnZipSFX binary (including SFXWiz) as part of a self-extracting archive; that is

permitted without inclusion of this license, as long as the normal SFX banner has not been removed from the binary or disabled.

3. Altered versions--including, but not limited to, ports to new operating systems, existing ports with new graphical interfaces, and dynamic, shared, or static library versions--must be plainly marked as such and must not be misrepresented as being the original source. Such altered versions also must not be misrepresented as being Info-ZIP releases--including, but not limited to, labeling of the altered versions with the names "Info-ZIP" (or any variation thereof, including, but not limited to, different capitalizations), "Pocket UnZip," "WiZ" or "MacZip" without the explicit permission of Info-ZIP. Such altered versions are further prohibited from misrepresentative

use of the Zip-Bugs or Info-ZIP e-mail addresses or of the Info-ZIP URL(s).

4. Info-ZIP retains the right to use the names “Info-ZIP,” “Zip,” “UnZip,” “UnZipSFX,” “WiZ,” “Pocket UnZip,” “Pocket Zip,” and “MacZip” for its own source and binary releases.

Software update

The Infotainment system can download and install selected software updates over a wireless connection.

Note

The availability of these over-the-air vehicle software updates varies by vehicle and country. Find more information on our home page.

Internet connection

Downloading over-the-air vehicle software updates requires internet connectivity, which can be accessed through the vehicle’s built-in OnStar

connection or another password-protected Wi-Fi hotspot, e.g. provided by a mobile phone.

To connect the Infotainment system to a hotspot, select **Settings** on the home screen, **Wi-Fi** and then **Manage Wi-Fi Networks**. Select the desired Wi-Fi network, and follow the on-screen prompts.

Updates

The system will prompt for certain updates to be downloaded and installed. There is also an option to check for updates manually.

To manually check for updates, select **Settings** on the home screen, **Software Information** and then **System Update**. Follow the on-screen prompts.

Note

Steps for downloading and installing updates may vary by vehicle.

Note

During the installation process, the vehicle may not be operational.

Registered trademarks

Apple Inc.

Apple CarPlay™ is a trademark of Apple Inc.

App Store® and iTunes Store® are registered trademarks of Apple Inc.

iPhone®, iPod®, iPod touch®, iPod nano®, iPad® and Siri® are registered trademarks of Apple Inc.

Bluetooth SIG, Inc.

Bluetooth® is a registered trademark of Bluetooth SIG, Inc.

DivX, LLC

DivX® and DivX Certified® are registered trademarks of DivX, LLC.

Google Inc.

Android™ and Google Play™ Store are trademarks of Google Inc.

Velcro Companies

Velcro® is a registered trademark of Velcro Companies.

Verband der Automobilindustrie e.V.

AdBlue® is a registered trademark of the VDA.

Vehicle data recording and privacy

Event data recorders

Electronic control units are installed in your vehicle. Control units process data which is received by vehicle sensors, for example, or which they generate themselves or exchange amongst themselves. Some control units are necessary for the safe functioning of your vehicle, others assist you while you drive (driver assistance systems), while others provide comfort or infotainment functions.

The following contains general information about data processing in the vehicle. You will find additional information as to which specific data is uploaded, stored and passed on to third parties and for what purpose in your vehicle under the key word Data Protection closely linked to the references for the affected functional characteristics in the relevant owner's manual or in the general terms of sale. These are also available online.

Operating data in the vehicle

Control units process data for operation of the vehicle.

This data includes, for example:

- vehicle status information (e.g. speed, movement delay, lateral acceleration, wheel rotation rate, "seat belts fastened" display)
- ambient conditions (e.g. temperature, rain sensor, distance sensor)

As a rule such data is transient and is not stored for longer than an operational cycle, and only processed on board the vehicle itself. Often control units include data storage (including the vehicle key). This is used to allow information to be documented temporarily or permanently on vehicle condition, component stress, maintenance requirements and technical events and errors.

Depending on technical equipment levels, the data stored is as follows:

- system component operating states (e.g. fill level, tyre pressure, battery status)
- faults and defects in important system components (e.g. lights, brakes)
- system reactions in special driving situations (e.g. triggering of an airbag, actuation of the stability control systems)
- information on events damaging the vehicle
- for electric vehicles the amount of charge in the high-voltage battery, estimated range

In special cases (e.g. if the vehicle has detected a malfunction), it may be necessary to save data that would otherwise just be volatile.

When you use services (e.g. repairs, maintenance), the operating data saved can be read together with the vehicle identification number and used where necessary. Staff working for the service network (e.g. garages, manufacturers) or third parties (e.g.

breakdown services) can read the data from the vehicle. The same applies to warranty work and quality assurance measures.

Data is generally read via the OBD (On-Board Diagnostics) port prescribed by law in the vehicle. The operating data read documents the technical condition of the vehicle or individual components and assists with fault diagnosis, compliance with warranty obligations and quality improvement. This data, in particular information on component stress, technical events, operator errors and other faults, is transmitted to the manufacturer where appropriate, together with the vehicle identification number. The manufacturer is also subject to product liability. The manufacturer potentially also uses operating data from vehicles for product recalls. This data can also be used to check customer warranty and guarantee claims.

Fault memories in the vehicle can be reset by a service company when carrying out servicing or repairs or at your request.

Comfort and infotainment functions

Comfort settings and custom settings can be stored in the vehicle and changed or reset at any time.

Depending on the equipment level in question, these include

- seat and steering wheel position settings
- chassis and air conditioning settings
- custom settings such as interior lighting

You can input your own data in the infotainment functions for your vehicle as part of the selected features.

Depending on the equipment level in question, these include

- multimedia data such as music, videos or photos for playback in an integrated multimedia system
- address book data for use with an integrated hands-free system or an integrated navigation system

- input destinations
- data on the use of online services

This data for comfort and infotainment functions can be stored locally in the vehicle or be kept on a device that you have connected to the vehicle (e.g. a smartphone, USB stick or MP3 player). Data that you have input yourself can be deleted at any time.

This data can only be transmitted out of the vehicle at your request, particularly when using online services in accordance with the settings selected by you.

Smartphone integration, e.g. Android Auto or Apple CarPlay

If your vehicle is equipped accordingly, you can connect your smartphone or another mobile device to the vehicle so that you can control it via the controls integrated in the vehicle. The smartphone image and sound can be output via the multimedia system in this case. At the same time, specific information is transmitted to your smartphone. Depending on the type of integration,

this includes data such as position data, day / night mode and other general vehicle information. For more information, please see the operating instructions for the vehicle / infotainment system.

Integration allows selected smartphone apps to be used, such as navigation or music playback. No further integration is possible between smartphone and vehicle, in particular active access to vehicle data. The nature of further data processing is determined by the provider of the app used. Whether you can define settings, and if so which ones, is dependent on the app in question and your smartphone's operating system.

Online services

If your vehicle has a radio network connection, this allows data to be exchanged between your vehicle and other systems. The radio network connection is made possible by means of a transmitter device in your vehicle or a mobile device provided by you (e.g. a smartphone). Online functions can be used via this radio network connection. These include online services and applications / apps provided to you by the manufacturer or other providers.

Proprietary services

In the case of the manufacturer's online services, the relevant functions are described by the manufacturer in an appropriate location (e.g. Owner's Manual, the manufacturer's website) and the associated data protection information is provided. Personal data may be used to provide online services. Data exchange for this purpose takes place via a protected connection, e.g. using the manufacturer's IT systems provided for the purpose. Collection,

processing and use of personal data for the purposes of preparation of services take place solely on the basis of legal permission, e.g. in the case of a legally prescribed emergency communication system or a contractual agreement, or by virtue of consent.

You can activate or deactivate the services and functions (which are subject to charges to some extent) and, in some cases, the vehicle's entire radio network connection. This does not include statutory functions and services such as an emergency communication system.

Third party services

If you make use of online services from other providers (third parties), these services are subject to the liability and data protection and usage conditions of the provider in question. The manufacturer frequently has no influence over the content exchanged in this regard.

Therefore, please note the nature, scope and purpose of the collection and use of personal data within the scope of third party services provided by the service provider in question.

Radio Frequency Identification (RFID)

RFID technology is used in some vehicles for functions such as tyre pressure monitoring and immobiliser. It is also used in connection with conveniences such as radio remote controls for door locking / unlocking and starting. RFID technology in Opel vehicles does not use or record personal information or link with any other Opel system containing personal information.

Index

A

Accessories and vehicle modifications	161
Active emergency braking....	73, 132
Adaptive cruise control	124
AdBlue.....	71, 107
Adjustable air vents	96
Advanced parking assist.....	141
Airbag and belt tensioners	67
Airbag deactivation	39, 67
Airbag label.....	34
Airbag system	34
Air conditioning regular operation	97
Air conditioning system	90
Air intake	97
Air vents.....	96
Antilock brake system	115
Antilock brake system (ABS)	69
Anti-theft alarm system	19
Anti-theft locking system	18
Appearance care.....	194
Armrest.....	31
Ashtrays	61
Automatic anti-dazzle	23
Automatic crash notification (ACN)	78
Automatic light control	81
Automatic locking	16
Automatic operation of electric parking brake off.....	69
Automatic transmission	110

Autostop.....	72, 103
Auxiliary heater.....	96

B

Battery discharge protection	88
BlueInjection.....	107
Bonnet	163
Brake and clutch fluid.....	201
Brake and clutch system	68
Brake assist	118
Brake fluid	166
Brakes.....	166
Breakdown.....	192
Bulb replacement	169

C

Capacities	210
Catalytic converter	107
Central locking system	12
Centre console storage	48
Changing tyre and wheel size ...	182
Charging system	67
Child locks	17
Child restraint installation locations	44
Child restraints.....	41
Child restraint systems	41
Cigarette lighter	61
Climate control systems.....	89
Clock.....	59
Control indicators.....	66

Control of the vehicle	99
Controls.....	55
Convex shape	21
Coolant and antifreeze.....	201
Cruise control	120
Cupholders	47
Curtain airbag system	39
Curve lighting.....	83

D

Danger, Warnings and Cautions ...	4
Daytime running lights	83
Declaration of conformity.....	212
DEF.....	107
Deflation detection system.....	71
Diesel exhaust fluid.....	107
Diesel fuel system bleeding	168
Door open	73
Door panel storage.....	48
Doors.....	18
Driver alert.....	154
Driver assistance systems.....	120
Driver Information Centre.....	73
Driving characteristics and towing tips	159
Driving hints.....	99

E

Electric adjustment	21
Electrical system.....	174
Electric parking brake.....	69, 115

Electric parking brake fault.....	69
Electronic climate control system	92
Electronic driving programmes ..	112
Electronic key system.....	11
Electronic Stability Control and Traction Control system....	70, 118
Emergency call.....	78
End-of-life vehicle recovery	162
Engine compartment fuse box ...	175
Engine coolant	165
Engine coolant temperature	70
Engine coolant temperature gauge	64
Engine data	207
Engine exhaust	106
Engine identification.....	204
Engine oil	164, 201, 205
Engine oil level monitor.....	65
Engine oil pressure	71
Entry lighting	88
Event data recorders.....	217
Exhaust filter.....	70, 106
Exit lighting	88
Exterior care	194
Exterior light	72
Exterior lighting.....	80
Exterior mirrors.....	21

F

Fault	113
Fixed air vents	97
Floor mats.....	196
Folding mirrors	21
Forward collision alert.....	135
Front airbag system	38
Front fog lights	72, 85, 171
Front pedestrian protection.....	137
Front seats.....	28
Front turn lights	171
Fuel.....	155
Fuel for diesel engines	156
Fuel for petrol engines	155
Fuel gauge	64
Fuses	174

G

Gauges.....	63
Gear selection	111
Gear shifting.....	70
General information	158
Glass panel	26
Glovebox	47

H

Halogen headlights	169
Hand brake.....	115
Hazard warning flashers	85
Headlight flash	82
Headlight range adjustment	82

Headlights.....	80
Headlights when driving abroad ..	83
Head restraints	27
Heated mirrors	22
Heated rear window	25
Heated steering wheel	55
Heating	31
Heating and ventilation system ...	89
High beam	72, 81
High beam assist.....	72, 81
Hill start assist	118
Horn	56
I	
Identification plate	203
Ignition switch positions	99
Immobiliser	20
Indicators.....	63
Inductive charging.....	60
Info Display.....	75
Instrument cluster	62
Instrument panel fuse box	176
Instrument panel illumination control	87
Instrument panel overview	6
Interior care	196
Interior lighting.....	87
Interior lights	87, 174
Interior mirrors.....	22

Interruption of power supply	113
Introduction	3

J

Jump starting	191
---------------------	-----

K

Keys	9
Keys, locks.....	9

L

Lane keep assist.....	70, 152
Lashing eyes	51
LED headlights.....	72, 83, 171
Light switch	80
Load compartment	18, 49
Load compartment cover	50
Loading information	52
Low beam.....	72
Low fuel	72

M

Malfunction indicator light	68
Manual anti-dazzle	22
Manual mode	112
Manual seat adjustment.....	29
Manual transmission	114
Massage.....	32
Misted light covers	86

N

New vehicle running-in	99
Number plate light	174

O

Object detection systems.....	138
Odometer	63
Oil, engine.....	201, 205
Opel Connect.....	78
Outside temperature	58
Overrun cut-off	103

P

Panoramic roof.....	26
Panoramic view system.....	148
Parking	105
Parking assist	138
Parking brake.....	69, 115
Parking lights	86
Particulate filter.....	106
Performance	208
Performing work	163
Peripheral lighting.....	88
Power button.....	100
Power outlets	59
Power seat adjustment	30
Power windows	23
Preheating	70
Puncture.....	187

Q			
Quickheat.....	96		
R			
Radio Frequency Identification (RFID).....	220		
Radio remote control	10		
Rain sensor.....	72		
REACH.....	214		
Reading lights	87		
Rear floor storage cover	51		
Rear fog light	72, 86, 172		
Rear view camera	150		
Rear window wiper and washer . .	58		
Recommended fluids and lubricants	201, 205		
Refuelling	157		
Registered trademarks.....	216		
Reversing lights	86		
Ride control systems.....	118		
Roadside assistance.....	78		
Roller blinds	26		
Roof.....	26		
Roof load.....	52		
Roof rack	51		
S			
Seat belt reminder	66		
Seat belts	32		
Seat heating.....	31		
Seat position	28		
Selective catalytic reduction.....	107		
Selector lever.....	111		
Service	97, 198		
Service display	65		
Service information	198		
Service vehicle soon	68		
Side airbag system	38		
Side blind spot alert.....	146		
Sidelights.....	80		
Smart access.....	12, 100		
Software acknowledgement.....	214		
Software update.....	216		
SOS.....	78		
Spare wheel	187		
Speed limiter.....	122		
Speedometer	63		
Starting and operating.....	99		
Starting the engine	101		
Steering.....	99		
Steering wheel adjustment	55		
Steering wheel controls	55		
Stop engine.....	68		
Stop-start system.....	103		
Storage.....	47		
Storage compartments.....	47		
Sunvisor lights	87		
Sun visors	25		
Symbols	4		
System check.....	68		
T			
Tachometer	64		
Tailgate.....	18		
Tail lights	172		
Three-point seat belt	33		
Tools	178		
Tow bar.....	158		
Towing.....	158, 192		
Towing another vehicle	193		
Towing the vehicle	192		
Traffic sign assistant.....	151		
Trailer coupling.....	158		
Trailer towing	159		
Transmission display	110		
Tread depth	181		
Trip odometer	63		
Turn lights	66, 85		
Tyre chains	182		
Tyre deflation detection system .	180		
Tyre designations	179		
Tyre pressure	179		
Tyre pressures	211		
Tyre repair kit	183		
U			
Ultrasonic parking assist.....	138		
Upholstery.....	196		
USB port.....	59		
Using this manual	3		

V

Vehicle battery	166
Vehicle checks.....	163
Vehicle data.....	205
Vehicle data recording and privacy.....	217
Vehicle dimensions	209
Vehicle identification number ...	203
Vehicle jack.....	178
Vehicle locator lighting.....	88
Vehicle messages	76
Vehicle personalisation	77
Vehicle security.....	18
Vehicle specific data	3
Vehicle storage.....	162
Vehicle tools.....	178
Ventilation.....	89

W

Warning chimes	77
Warning lights.....	63
Washer fluid	165
Wheel changing	186
Wheel covers	182
Wheels and tyres	179
Windows.....	23
Windscreen.....	23
Windscreen wiper and washer ...	56
Winter tyres	179
Wiper blade replacement	168

www.opel.com

Copyright by Opel Automobile GmbH, Rüsselsheim, Germany.

The information contained in this publication is effective as of the date indicated below. Opel Automobile GmbH reserves the right to make changes to the technical specifications, features and design of the vehicles relative to the information in this publication as well as changes to the publication itself.

Edition: October 2019, Opel Automobile GmbH, Rüsselsheim.

Printed on chlorine-free bleached paper.

ID-OCRFOBSE1910-en

